

Simulink®

Developing S-Functions

R2013a

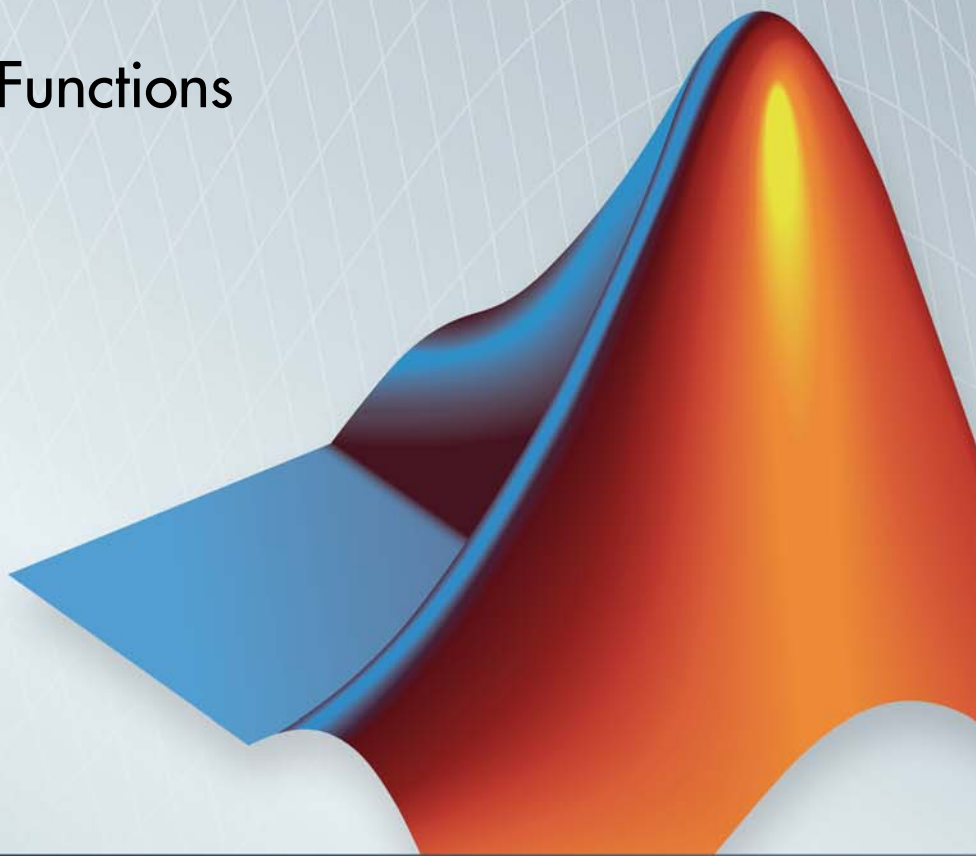

MATLAB® & SIMULINK®



How to Contact MathWorks



www.mathworks.com Web
comp.soft-sys.matlab Newsgroup
www.mathworks.com/contact_TS.html Technical Support



suggest@mathworks.com Product enhancement suggestions
bugs@mathworks.com Bug reports
doc@mathworks.com Documentation error reports
service@mathworks.com Order status, license renewals, passcodes
info@mathworks.com Sales, pricing, and general information



508-647-7000 (Phone)



508-647-7001 (Fax)



The MathWorks, Inc.
3 Apple Hill Drive
Natick, MA 01760-2098

For contact information about worldwide offices, see the MathWorks Web site.

Developing S-Functions

© COPYRIGHT 1998–2013 by The MathWorks, Inc.

The software described in this document is furnished under a license agreement. The software may be used or copied only under the terms of the license agreement. No part of this manual may be photocopied or reproduced in any form without prior written consent from The MathWorks, Inc.

FEDERAL ACQUISITION: This provision applies to all acquisitions of the Program and Documentation by, for, or through the federal government of the United States. By accepting delivery of the Program or Documentation, the government hereby agrees that this software or documentation qualifies as commercial computer software or commercial computer software documentation as such terms are used or defined in FAR 12.212, DFARS Part 227.72, and DFARS 252.227-7014. Accordingly, the terms and conditions of this Agreement and only those rights specified in this Agreement, shall pertain to and govern the use, modification, reproduction, release, performance, display, and disclosure of the Program and Documentation by the federal government (or other entity acquiring for or through the federal government) and shall supersede any conflicting contractual terms or conditions. If this License fails to meet the government's needs or is inconsistent in any respect with federal procurement law, the government agrees to return the Program and Documentation, unused, to The MathWorks, Inc.

Trademarks

MATLAB and Simulink are registered trademarks of The MathWorks, Inc. See www.mathworks.com/trademarks for a list of additional trademarks. Other product or brand names may be trademarks or registered trademarks of their respective holders.

Patents

MathWorks products are protected by one or more U.S. patents. Please see www.mathworks.com/patents for more information.

Revision History

October 1998	First printing	Revised for Version 3.0 (Release R11)
November 2000	Second printing	Revised for Version 4.0 (Release R12)
July 2002	Third printing	Revised for Version 5.0 (Release R13)
April 2003	Online only	Revised for Version 5.1 (Release R13SP1)
April 2004	Online only	Revised for Version 5.1.1 (Release R13SP1+)
June 2004	Online only	Revised for Version 6.0 (Release R14)
October 2004	Online only	Revised for Version 6.1 (Release R14SP1)
March 2005	Online only	Revised for Version 6.2 (Release R14SP2)
September 2005	Online Only	Revised for Version 6.3 (Release R14SP3)
March 2006	Online only	Revised for Version 6.4 (Release 2006a)
September 2006	Online only	Revised for Version 6.5 (Release 2006b)
March 2007	Online only	Revised for Version 6.6 (Release 2007a)
September 2007	Online only	Revised for Version 7.0 (Release 2007b)
March 2008	Online only	Revised for Version 7.1 (Release 2008a)
October 2008	Online only	Revised for Version 7.2 (Release 2008b)
March 2009	Online only	Revised for Version 7.3 (Release 2009a)
September 2009	Online only	Revised for Version 7.4 (Release 2009b)
March 2010	Online only	Revised for Version 7.5 (Release 2010a)
September 2010	Online only	Revised for Version 7.6 (Release 2010b)
April 2011	Online only	Revised for Version 7.7 (Release 2011a)
September 2011	Online only	Revised for Version 7.8 (Release 2011b)
March 2012	Online only	Revised for Version 7.9 (Release 2012a)
September 2012	Online only	Revised for Version 8.0 (Release 2012b)
March 2013	Online only	Revised for Version 8.1 (Release 2013a)

Overview of S-Functions

1

What Is an S-Function?	1-2
Use S-Functions in Models	1-3
Overview	1-3
Passing Parameters to S-Functions	1-5
When to Use an S-Function	1-7
How S-Functions Work	1-9
Introduction	1-9
Mathematics of Simulink Blocks	1-9
Simulation Stages	1-10
S-Function Callback Methods	1-11
Implementing S-Functions	1-13
MATLAB S-Functions	1-13
MEX S-Functions	1-14
S-Function Callback Methods	1-15
Callback Methods Overview	1-15
Callback Methods for C MEX S-Functions	1-16
Callback Methods for Level-2 MATLAB S-Functions	1-18
S-Function Concepts	1-20
Direct Feedthrough	1-20
Dynamically Sized Arrays	1-21
Setting Sample Times and Offsets	1-22
S-Function Examples	1-27
Overview of Examples	1-27
Level-2 MATLAB S-Function Examples	1-30
Level-1 MATLAB S-Function Examples	1-30
C S-Function Examples	1-32
Fortran S-Function Examples	1-36

C++ S-Function Examples	1-37
-------------------------------	------

Selecting an S-Function Implementation

2

Available S-Function Implementations	2-2
S-Function Types	2-3
Implement S-Functions	2-5
S-Function Features	2-8
S-Function Limitations	2-12
S-Functions Incorporate Legacy C Code	2-14
Overview	2-14
Using a Hand-Written S-Function to Incorporate Legacy Code	2-15
Using the S-Function Builder to Incorporate Legacy Code	2-17
Using the Legacy Code Tool to Incorporate Legacy Code ..	2-22

Writing S-Functions in MATLAB

3

Introduction	3-2
Write Level-2 MATLAB S-Functions	3-4
About Level-2 MATLAB S-Functions	3-4
About Run-Time Objects	3-5
Level-2 MATLAB S-Function Template	3-5
Level-2 MATLAB S-Function Callback Methods	3-6
Using the setup Method	3-8

Example of Writing a Level-2 MATLAB S-Function	3-8
Instantiating a Level-2 MATLAB S-Function	3-12
Operations for Variable-Size Signals	3-12
Generating Code from a Level-2 MATLAB S-Function ...	3-13
MATLAB S-Function Examples	3-13
Maintain Level-1 MATLAB S-Functions	3-14
About the Maintenance of Level-1 MATLAB	
S-Functions	3-14
Level-1 MATLAB S-Function Arguments	3-15
Level-1 MATLAB S-Function Outputs	3-16
Define S-Function Block Characteristics	3-17
Processing S-Function Parameters	3-18
Convert Level-1 MATLAB S-Functions to Level-2	3-18

Writing S-Functions in C

4

Introduction	4-2
About Writing C S-Functions	4-2
Creating C MEX S-Functions	4-3
Build S-Functions Automatically	4-5
About Building S-Functions Automatically	4-5
Deploying the Generated S-Function	4-10
How the S-Function Builder Builds an S-Function	4-11
S-Function Builder Dialog Box	4-12
About S-Function Builder	4-12
Parameters/S-Function Name Pane	4-14
Port/Parameter Pane	4-15
Initialization Pane	4-16
Data Properties Pane	4-18
Input Ports Pane	4-19
Output Ports Pane	4-20
Parameters Pane	4-22
Data Type Attributes Pane	4-23
Libraries Pane	4-24
Outputs Pane	4-26

Continuous Derivatives Pane	4-30
Discrete Update Pane	4-32
Build Info Pane	4-34
Example: Modeling a Two-Input/Two-Output System	4-37
Basic C MEX S-Function	4-43
Introducing an Example of a Basic C MEX S-Function	4-43
Defines and Includes	4-46
Callback Method Implementations	4-46
Simulink/Simulink Coder Interfaces	4-48
Building the Timestwo Example	4-49
Templates for C S-Functions	4-50
About the Templates for C S-Functions	4-50
S-Function Source File Requirements	4-50
The SimStruct	4-53
Data Types in S-Functions	4-53
Compiling C S-Functions	4-53
Integrate C Functions Using Legacy Code Tool	4-55
Overview	4-55
Example of Integrating Existing C Functions into Simulink	
Models with the Legacy Code Tool	4-58
Registering Legacy Code Tool Data Structures	4-61
Declaring Legacy Code Tool Function Specifications	4-63
Generating and Compiling the S-Functions	4-71
Generating a Masked S-Function Block for Calling a	
Generated S-Function	4-72
Forcing Simulink Accelerator Mode to Use S-Function TLC	
Inlining Code	4-72
Calling Legacy C++ Functions	4-73
Handling Multiple Registration Files	4-73
Deploying Generated S-Functions	4-74
Legacy Code Tool Examples	4-74
Legacy Code Tool Limitations	4-75
Simulink Engine Interaction with C S-Functions	4-76
Introduction	4-76
Process View	4-76
Data View	4-84
Write Callback Methods	4-89

S-Functions in Normal Mode Referenced Models	4-90
Supporting the Use of Multiple Instances of Referenced Models That Are in Normal Mode	4-91
Debug C MEX S-Functions	4-92
About Debugging C MEX S-Functions	4-92
Debug in Simulink Environment	4-92
Debug Using Third-Party Software	4-96
Convert Level-1 C MEX S-Functions	4-100
Guidelines for Converting Level-1 C MEX S-Functions to Level-2	4-100
Obsolete Macros	4-103

Creating C++ S-Functions

5

Create a C++ Source File	5-2
Make C++ Objects Persistent	5-3
Build C++ S-Functions	5-5
C++ References	5-6

Creating Fortran S-Functions

6

Level-1 Versus Level-2 S-Functions	6-2
Create Level-1 Fortran S-Functions	6-3
Fortran MEX Template File	6-3
Example of a Level-1 Fortran S-Function	6-3
Inline Code Generation Example	6-6

Create Level-2 Fortran S-Functions	6-8
About Creating Level-2 Fortran S-Functions	6-8
Template File	6-8
C/Fortran Interfacing Tips	6-8
Constructing the Gateway	6-13
Example C MEX S-Function Calling Fortran Code	6-16
Port Legacy Code	6-18
Find the States	6-18
Sample Times	6-19
Store Data	6-19
Use Flints if Needed	6-19
Considerations for Real Time	6-20

Using Work Vectors

7

DWork Vector Basics	7-2
What is a DWork Vector?	7-2
Advantages of DWork Vectors	7-2
DWork Vectors and the Simulink Engine	7-3
DWork Vectors and the Simulink Coder Product	7-4
Types of DWork Vectors	7-5
How to Use DWork Vectors	7-7
Using DWork Vectors in C MEX S-Functions	7-7
DWork Vector C MEX Macros	7-10
Using DWork Vectors in Level-2 MATLAB S-Functions ..	7-12
Using DWork Vectors With Legacy Code	7-14
DWork Vector Examples	7-15
General DWork Vector	7-15
DWork Scratch Vector	7-17
DState Work Vector	7-19
DWork Mode Vector	7-21
Level-2 MATLAB S-Function DWork Vector	7-24

Elementary Work Vectors	7-26
Description of Elementary Work Vector	7-26
Relationship to DWork Vectors	7-26
Using Elementary Work Vectors	7-27
Additional Work Vector Macros	7-29
Elementary Work Vector Examples	7-30

Implementing Block Features

8

Dialog Parameters	8-2
About Dialog Parameters	8-2
Tunable Parameters	8-5
 Run-Time Parameters	 8-8
About Run-Time Parameters	8-8
Creating Run-Time Parameters	8-9
Updating Run-Time Parameters	8-15
Tuning Run-Time Parameters	8-16
Accessing Run-Time Parameters	8-17
 Input and Output Ports	 8-18
Creating Input Ports for C S-Functions	8-18
Creating Input Ports for Level-2 MATLAB S-Functions ..	8-22
Creating Output Ports for C S-Functions	8-24
Creating Output Ports for Level-2 MATLAB S-Functions	8-25
Scalar Expansion of Inputs	8-25
Masked Multiport S-Functions	8-27
 Custom Data Types	 8-28
Custom Data Types in C S-Functions	8-28
Using Simulink Recognizable Data Types in C S-Functions	8-28
Using Opaque Data Types in C S-Functions	8-29
Using Custom Data Types in Level-2 MATLAB S-Functions	8-30
 Sample Times	 8-32

About Sample Times	8-32
Block-Based Sample Times	8-33
Specifying Port-Based Sample Times	8-37
Hybrid Block-Based and Port-Based Sample Times	8-43
Multirate S-Function Blocks	8-44
Multirate S-Functions and Sample Time Hit Calculations	8-46
Synchronizing Multirate S-Function Blocks	8-46
Specifying Model Reference Sample Time Inheritance	8-47
Zero Crossings	8-50
S-Function Compliance with the SimState	8-54
SimState Compliance Specification for Level-2 MATLAB S-Functions	8-54
SimState Compliance Specification for C-MEX S-Functions	8-55
Matrices in C S-Functions	8-57
MX Array Manipulation	8-57
Memory Allocation	8-58
Function-Call Subsystems and S-Functions	8-59
Sim Viewing Devices in External Mode	8-65
Frame-Based Signals	8-66
About Frame-Based Signals	8-66
Using Frame-Based Signals in C S-Functions	8-66
Using Frame-Based Signals in Level-2 MATLAB S-Functions	8-68
Error Handling	8-69
About Handling Errors	8-69
Exception Free Code	8-70
ssSetErrorStatus Termination Criteria	8-71
Checking Array Bounds	8-72
C MEX S-Function Examples	8-73
About S-Function Examples	8-73

Continuous States	8-73
Discrete States	8-80
Continuous and Discrete States	8-86
Variable Sample Time	8-94
Array Inputs and Outputs	8-100
Zero-Crossing Detection	8-111
Discontinuities in Continuous States	8-129

S-Function Callback Methods — Alphabetical List

9

S-Function SimStruct Functions Reference

10

S-Function SimStruct Functions	10-2
About SimStruct Functions	10-2
Language Support	10-2
The SimStruct	10-2
 SimStruct Macros and Functions Listed by Usage	 10-3
Buses	10-3
Data Type	10-4
Dialog Box Parameters	10-5
Error Handling and Status	10-6
Function Call	10-6
Input and Output Ports	10-7
Model Reference	10-14
Run-Time Parameters	10-15
Sample Time	10-16
Simulation Information	10-17
State and Work Vector	10-20
Code Generation	10-23
Miscellaneous	10-25

Overview of S-Functions

- “What Is an S-Function?” on page 1-2
- “Use S-Functions in Models” on page 1-3
- “How S-Functions Work” on page 1-9
- “Implementing S-Functions” on page 1-13
- “S-Function Callback Methods” on page 1-15
- “S-Function Concepts” on page 1-20
- “S-Function Examples” on page 1-27

What Is an S-Function?

S-functions (system-functions) provide a powerful mechanism for extending the capabilities of the Simulink® environment. An *S-function* is a computer language description of a Simulink block written in MATLAB®, C, C++, or Fortran. C, C++, and Fortran S-functions are compiled as MEX files using the `mex` utility (see “Build MEX-Files”). As with other MEX files, S-functions are dynamically linked subroutines that the MATLAB interpreter can automatically load and execute.

S-functions use a special calling syntax called the S-function API that enables you to interact with the Simulink engine. This interaction is very similar to the interaction that takes place between the engine and built-in Simulink blocks.

S-functions follow a general form and can accommodate continuous, discrete, and hybrid systems. By following a set of simple rules, you can implement an algorithm in an S-function and use the S-Function block to add it to a Simulink model. After you write your S-function and place its name in an S-Function block (available in the User-Defined Functions block library), you can customize the user interface using masking (see “What Are Masks?”).

If you have Simulink Coder™, you can use S-functions with the software. You can also customize the code generated for S-functions by writing a Target Language Compiler (TLC) file. For more information, see “Insert S-Function Code”.

Use S-Functions in Models

In this section...
“Overview” on page 1-3
“Passing Parameters to S-Functions” on page 1-5
“When to Use an S-Function” on page 1-7

Overview

To incorporate a C MEX S-function or legacy Level-1 MATLAB S-function into a Simulink model, drag an S-Function block from the User-Defined Functions block library into the model. Then specify the name of the S-function in the **S-function name** field of the S-Function block's Block Parameters dialog box, as illustrated in the following figure.

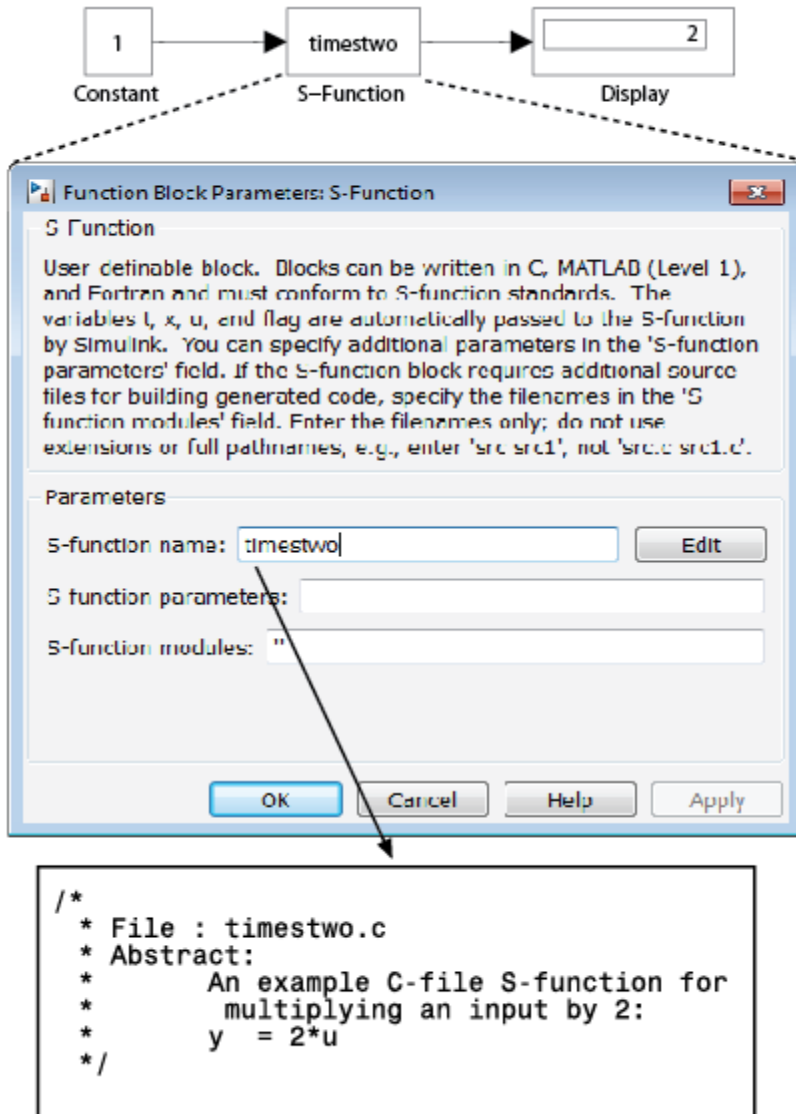

In this example, the model contains an S-Function block that references an instance of the C MEX file for the S-function `timestwo.c`.

Note If the MATLAB path includes a C MEX file and a MATLAB file having the same name referenced by an S-Function block, the S-Function block uses the C MEX file.

To incorporate a Level-2 MATLAB S-function into a model, drag a Level-2 MATLAB S-Function block from the User-Defined Functions library into the model. Specify the name of the S-function in the **S-function name** field.

Passing Parameters to S-Functions

The S-Function block **S-function parameters** and Level-2 MATLAB S-Function block **Parameters** fields allow you to specify parameter values to pass to the corresponding S-function. To use these fields, you must know the parameters the S-function requires and the order in which the function requires them. (If you do not know, consult the S-function's author, documentation, or source code.) Enter the parameters, separated by a comma, in the order required by the S-function. The parameter values can be constants, names of variables defined in the MATLAB or model workspace, or MATLAB expressions.

The following example illustrates usage of the **Parameters** field to enter user-defined parameters for a Level-2 MATLAB S-function.

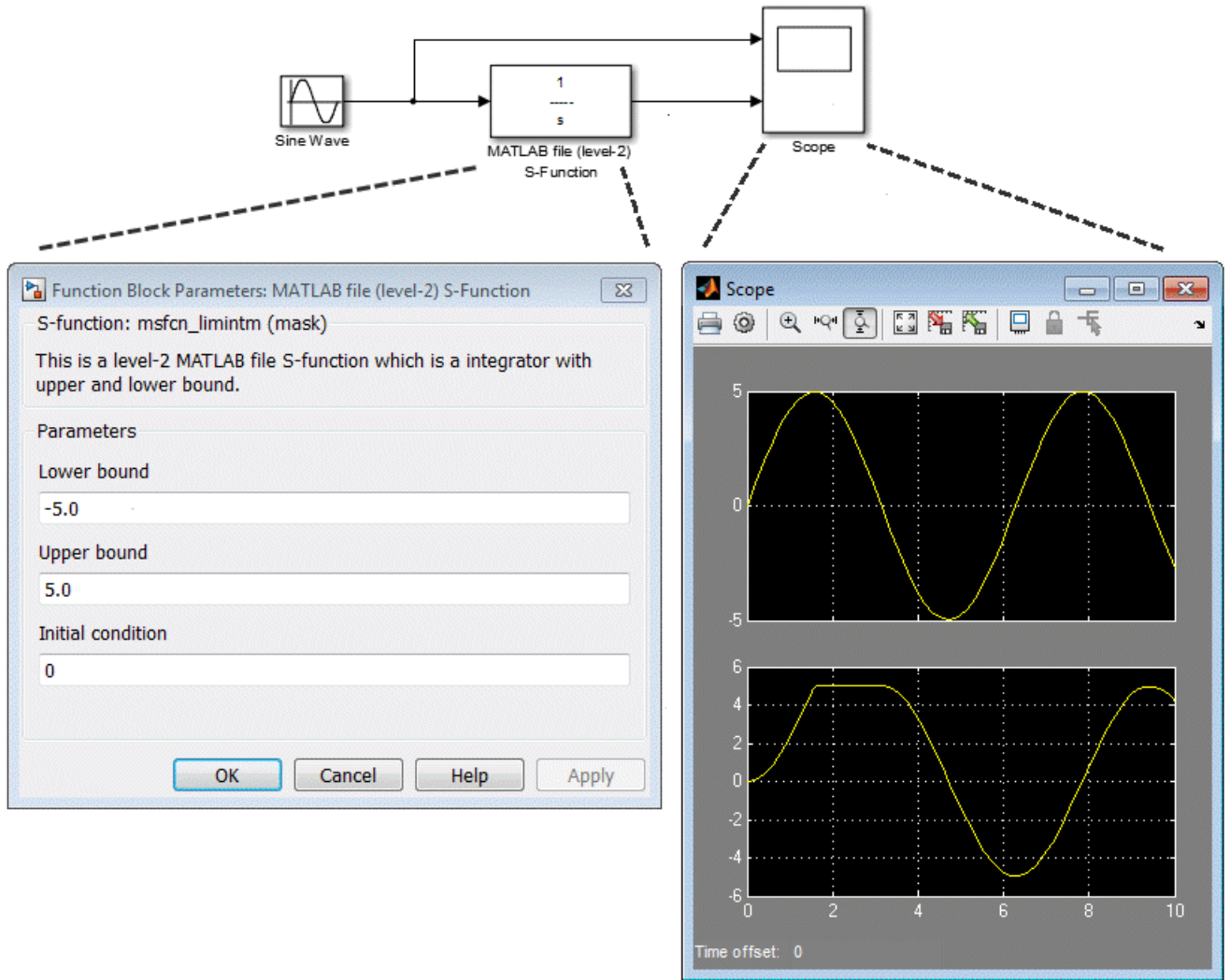

The model msfcdemo_limintm in this example incorporates the sample S-function msfcn_limintm.m.

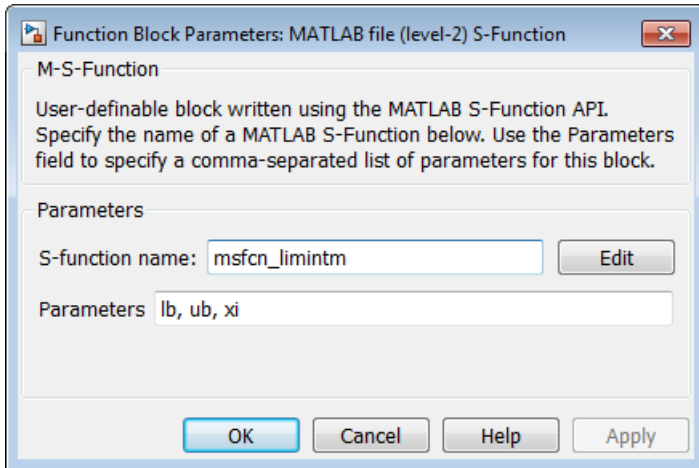

The `msfcn_limintm.m` S-function accepts three parameters: a lower bound, an upper bound, and an initial condition. The S-function outputs the time integral of the input signal if the time integral is between the lower and upper bounds, the lower bound if the time integral is less than the lower bound, and the upper bound if the time integral is greater than the upper bound. The dialog box in the example specifies a lower and upper bound and an initial condition of -5.0, 5.0, and 0, respectively. The scope shows the resulting output when the input is a sine wave of amplitude 1.

See “Processing S-Function Parameters” on page 3-18 and “Error Handling” on page 8-69 for information on how to access user-specified parameters in an S-function.

You can use the masking facility to create custom dialog boxes and icons for your S-Function blocks. Masked dialog boxes can make it easier to specify additional parameters for S-functions. For a discussion on masking, see “What Are Masks?”.

When to Use an S-Function

You can use S-functions for a variety of applications, including:

- Creating new general purpose blocks
- Adding blocks that represent hardware device drivers

- Incorporating existing C code into a simulation (see “Integrate C Functions Using Legacy Code Tool” on page 4-55)
- Describing a system as a set of mathematical equations
- Using graphical animations (see the inverted pendulum example, penddemo)

The most common use of S-functions is to create custom Simulink blocks (see “When to Create Custom Blocks”). When you use an S-function to create a general-purpose block, you can use it many times in a model, varying parameters with each instance of the block.

How S-Functions Work

In this section...

“Introduction” on page 1-9

“Mathematics of Simulink Blocks” on page 1-9

“Simulation Stages” on page 1-10

“S-Function Callback Methods” on page 1-11

Introduction

To create S-functions, you need to understand how S-functions work. Such knowledge requires an understanding of how the Simulink engine simulates a model, including the mathematics of blocks. This section begins by explaining the mathematical relationships between the inputs, states, and outputs of a block.

Mathematics of Simulink Blocks

A Simulink block consists of a set of inputs, a set of states, and a set of outputs, where the outputs are a function of the simulation time, the inputs, and the states.

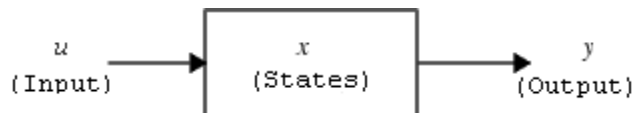

The following equations express the mathematical relationships between the inputs, outputs, states, and simulation time

$$\begin{aligned}
 y &= f_0(t, x, u) && \text{(Outputs)} \\
 \dot{x} &= f_d(t, x, u) && \text{(Derivatives)} \\
 x_{d_{k+1}} &= f_u(t, x_c, x_{d_k}, u), && \text{(Update)}
 \end{aligned}$$

where $x = [x_c; x_d]$.

Simulation Stages

Execution of a Simulink model proceeds in stages. First comes the initialization phase. In this phase, the Simulink engine incorporates library blocks into the model, propagates signal widths, data types, and sample times, evaluates block parameters, determines block execution order, and allocates memory. The engine then enters a *simulation loop*, where each pass through the loop is referred to as a *simulation step*. During each simulation step, the engine executes each block in the model in the order determined during initialization. For each block, the engine invokes functions that compute the block states, derivatives, and outputs for the current sample time.

The following figure illustrates the stages of a simulation. The inner integration loop takes place only if the model contains continuous states. The engine executes this loop until the solver reaches the desired accuracy for the state computations. The entire simulation loop then continues until the simulation is complete. See “Simulating Dynamic Systems” in *Using Simulink* for more detailed information on how the engine executes a model. See “Simulink Engine Interaction with C S-Functions” on page 4-76 for a description of how the engine calls the S-function API during initialization and simulation.

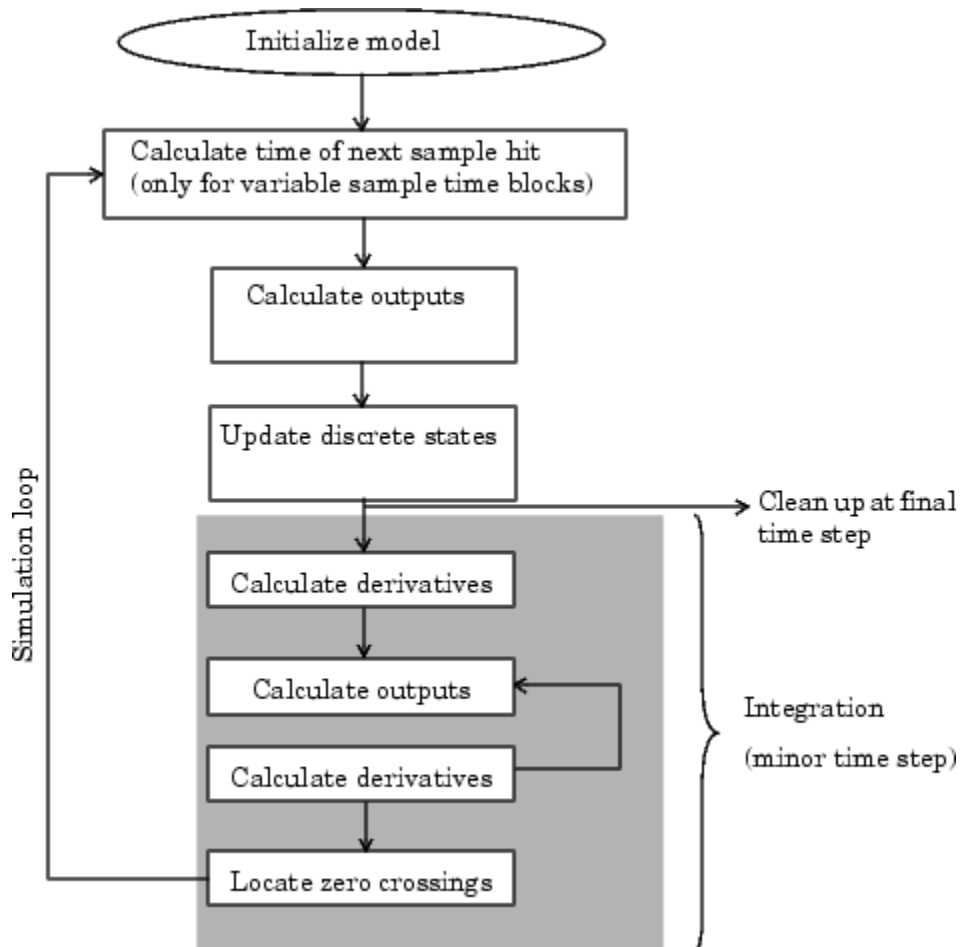

How the Simulink® Engine Performs Simulation

S-Function Callback Methods

An S-function comprises a set of *S-function callback methods* that perform tasks required at each simulation stage. During simulation of a model, at each simulation stage, the Simulink engine calls the appropriate methods for each S-Function block in the model. Tasks performed by S-function callback methods include:

- Initialization — Prior to the first simulation loop, the engine initializes the S-function, including:
 - Initializing the `SimStruct`, a simulation structure that contains information about the S-function
 - Setting the number and dimensions of input and output ports
 - Setting the block sample times
 - Allocating storage areas
- Calculation of next sample hit — If you created a variable sample time block, this stage calculates the time of the next sample hit; that is, it calculates the next step size.
- Calculation of outputs in the major time step — After this call is complete, all the block output ports are valid for the current time step.
- Update of discrete states in the major time step — In this call, the block performs once-per-time-step activities such as updating discrete states.
- Integration — This applies to models with continuous states and/or nonsampled zero crossings. If your S-function has continuous states, the engine calls the output and derivative portions of your S-function at minor time steps. This is so the solvers can compute the states for your S-function. If your S-function has nonsampled zero crossings, the engine also calls the output and zero-crossings portions of your S-function at minor time steps so that it can locate the zero crossings.

Note See “Simulating Dynamic Systems” for an explanation of major and minor time steps.

Implementing S-Functions

In this section...
“MATLAB S-Functions” on page 1-13
“MEX S-Functions” on page 1-14

MATLAB S-Functions

Level-2 MATLAB S-functions allow you to create blocks with many of the features and capabilities of Simulink built-in blocks, including:

- Multiple input and output ports
- The ability to accept vector or matrix signals
- Support for various signal attributes including data type, complexity, and signal frames
- Ability to operate at multiple sample rates

A Level-2 MATLAB S-function consists of a `setup` routine to configure the basic properties of the S-function, and a number of callback methods that the Simulink engine invokes at appropriate times during the simulation.

A basic annotated version of the template resides at `msfuntmpl_basic.m`.

The template consists of a top-level `setup` function and a set of skeleton local functions, each of which corresponds to a particular callback method. Each callback method performs a specific S-function task at a particular point in the simulation. The engine invokes the local functions using function handles defined in the `setup` routine. See “Level-2 MATLAB S-Function Callback Methods” on page 3-6 for a table of the supported Level-2 MATLAB S-function callback methods.

A more detailed Level-2 MATLAB S-function template resides at `msfuntmpl.m`.

We recommend that you follow the structure and naming conventions of the templates when creating Level-2 MATLAB S-functions. This makes it easier for others to understand and maintain the MATLAB S-functions that you

create. See “Write Level-2 MATLAB S-Functions” on page 3-4 for information on creating Level-2 MATLAB S-functions.

MEX S-Functions

Like a Level-2 MATLAB S-function, a MEX S-function consists of a set of callback methods that the Simulink engine invokes to perform various block-related tasks during a simulation. MEX S-functions can be implemented in C, C++, or Fortran. The engine directly invokes MEX S-function routines instead of using function handles as with MATLAB S-functions. Because the engine invokes the functions directly, MEX S-functions must follow standard naming conventions specified by the S-function API.

An annotated C MEX S-function template resides at `sfuntmpl_doc.c`.

The template contains skeleton implementations of all the required and optional callback methods that a C MEX S-function can implement.

For a more basic version of the template see `sfuntmpl_basic.c`.

MEX Versus MATLAB S-Functions

Level-2 MATLAB and MEX S-functions each have advantages. The advantage of Level-2 MATLAB S-functions is speed of development. Developing Level-2 MATLAB S-functions avoids the time consuming compile-link-execute cycle required when developing in a compiled language. Level-2 MATLAB S-functions also have easier access to MATLAB toolbox functions and can utilize the MATLAB Editor/Debugger.

MEX S-functions are more appropriate for integrating legacy code into a Simulink model. For more complicated systems, MEX S-functions may simulate faster than MATLAB S-functions because the Level-2 MATLAB S-function calls the MATLAB interpreter for every callback method.

See “Available S-Function Implementations” on page 2-2 for information on choosing the type of S-function best suited for your application.

S-Function Callback Methods

In this section...

“Callback Methods Overview” on page 1-15

“Callback Methods for C MEX S-Functions” on page 1-16

“Callback Methods for Level-2 MATLAB S-Functions” on page 1-18

Callback Methods Overview

Every S-function must implement a set of methods, called *callback methods*, that the Simulink engine invokes when simulating a model that contains the S-function.

The S-function callback methods perform tasks required at each simulation stage. During simulation of a model, at each simulation stage the Simulink engine calls the appropriate methods for each S-Function block in the model.

Tasks performed by S-function callback methods include:

- **Initialization** — Prior to the first simulation loop, the engine initializes the S-function, including:
 - Initializing the `SimStruct`, a simulation structure that contains information about the S-function
 - Setting the number and dimensions of input and output ports
 - Setting the block sample times
 - Allocating storage areas
- **Calculation of next sample hit** — If you created a variable sample time block, this stage calculates the time of the next sample hit; that is, it calculates the next step size.
- **Calculation of outputs in the major time step** — After this call is complete, all the block output ports are valid for the current time step.
- **Update of discrete states in the major time step** — In this call, the block performs once-per-time-step activities such as updating discrete states.

- **Integration** — This applies to models with continuous states and/or nonsampled zero crossings. If your S-function has continuous states, the engine calls the output and derivative portions of your S-function at minor time steps. This is so the solvers can compute the states for your S-function. If your S-function has nonsampled zero crossings, the engine also calls the output and zero-crossings portions of your S-function at minor time steps so that it can locate the zero crossings.

Note See “Simulating Dynamic Systems” for an explanation of major and minor time steps.

Some callback methods are optional. The engine invokes an optional callback only if the S-function defines the callback.

Callback Methods for C MEX S-Functions

Required Callback Methods

C MEX S-functions must implement the following callback methods:

- `mdlInitializeSizes` – Specifies the sizes of various parameters in the `SimStruct`, such as the number of output ports for the block.
- `mdlInitializeSampleTimes` – Specifies the sample time(s) of the block.
- `mdlOutputs` – Calculates the output of the block.
- `mdlTerminate` – Performs any actions required at the termination of the simulation. If no actions are required, this function can be implemented as a stub.

For information on writing callback methods, see “Write Callback Methods” on page 4-89.

Optional Callback Methods

The following callback methods are optional. The engine invokes an optional callback only if the S-function defines the callback.

- mdlCheckParameters
- mdlDerivatives
- mdlDisable
- mdlEnable
- mdlGetSimState
- mdlGetTimeOfNextVarHit
- mdlInitializeConditions
- mdlProcessParameters
- mdlProjection
- mdlRTW
- mdlSetDefaultPortComplexSignals
- mdlSetDefaultPortDataTypes
- mdlSetDefaultPortDimensionInfo
- mdlSetInputPortComplexSignal
- mdlSetInputPortDataType
- mdlSetInputPortDimensionInfo
- mdlSetInputPortDimensionsModeFcn
- mdlSetInputPortFrameData
- mdlSetInputPortSampleTime
- mdlSetInputPortWidth
- mdlSetOutputPortComplexSignal
- mdlSetOutputPortDataType
- mdlSetOutputPortDimensionInfo
- mdlSetOutputPortSampleTime
- mdlSetOutputPortWidth
- mdlSetSimState
- mdlSetWorkWidths

- mdlSimStatusChange
- mdlStart
- mdlUpdate
- mdlZeroCrossings

Callback Methods for Level-2 MATLAB S-Functions

Required Callback Methods

Level-2 MATLAB S-functions must implement the following callback methods:

- **setup** – Specifies the sizes of various parameters in the `SimStruct`, such as the number of output ports for the block.
- **Outputs** – Calculates the output of the block.
- **Terminate** – Performs any actions required at the termination of the simulation. If no actions are required, this function can be implemented as a stub.

For information on writing callback methods, see “Write Level-2 MATLAB S-Functions” on page 3-4.

Optional Callback Methods

The following callback methods are optional. The engine invokes an optional callback only if the S-function defines the callback.

- CheckParameters
- Derivatives
- Disable
- Enable
- GetSimState
- InitializeConditions
- PostPropagationSetup
- ProcessParameters

- Projection
- SetInputPortComplexSignal
- SetInputPortDataType
- SetInputPortDimensions
- SetInputPortDimensionsMode
- SetInputPortSamplingMode
- SetInputPortSampleTime
- SetOutputPortComplexSignal
- SetOutputPortDataType
- SetOutputPortDimensions
- SetOutputPortSampleTime
- SetSimState
- SimStatusChange
- Start
- Update
- WriteRTW

S-Function Concepts

In this section...

“Direct Feedthrough” on page 1-20

“Dynamically Sized Arrays” on page 1-21

“Setting Sample Times and Offsets” on page 1-22

Direct Feedthrough

Direct feedthrough means that the output (or the variable sample time for variable sample time blocks) is controlled directly by the value of an input port signal. Typically, an S-function input port has direct feedthrough if

- The output function (`mdlOutputs`) is a function of the input u . That is, there is direct feedthrough if the input u is accessed by `mdlOutputs`. Outputs can also include graphical outputs, as in the case of an XY Graph scope.
- The “time of next hit” function (`mdlGetTimeOfNextVarHit`) of a variable sample time S-function accesses the input u .

An example of a system that requires its inputs (that is, has direct feedthrough) is the operation

$$y = k \times u,$$

where u is the input, k is the gain, and y is the output.

An example of a system that does not require its inputs (that is, does not have direct feedthrough) is the simple integration algorithm

$$y = x,$$

$$\dot{x} = u,$$

where x is the state, \dot{x} is the state derivative with respect to time, u is the input, and y is the output. Simulink integrates the variable \dot{x} .

It is very important to set the direct feedthrough flag correctly because it affects the execution order of the blocks in your model and is used to detect algebraic loops (see “Algebraic Loops” in *Using Simulink*). If the simulation results for a model containing your S-function do not converge, or the simulation fails, you may have the direct feedthrough flag set incorrectly. Try turning on the direct feedthrough flag and setting the **Algebraic loop** solver diagnostic to warning (see the “Algebraic loop” option on the “Diagnostics Pane: Solver” reference page in *Simulink Graphical User Interface*). Subsequently running the simulation displays any algebraic loops in the model and shows if the engine has placed your S-function within an algebraic loop.

Dynamically Sized Arrays

You can write your S-function to support arbitrary input dimensions. In this case, the Simulink engine determines the actual input dimensions when the simulation is started by evaluating the dimensions of the input vectors driving the S-function. Your S-function can also use the input dimensions to determine the number of continuous states, the number of discrete states, and the number of outputs.

Note A dynamically sized input can have a different size for each instance of the S-function in a particular model or during different simulations, however the input size of each instance of the S-function is static over the course of a particular simulation.

A C MEX S-function and Level-2 MATLAB S-function can have multiple input and output ports and each port can have different dimensions. The number of dimensions and the size of each dimension can be determined dynamically.

For example, the following illustration shows two instances of the same S-Function block in a model.

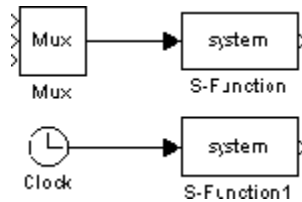

The upper S-Function block is driven by a block with a three-element output vector. The lower S-Function block is driven by a block with a scalar output. By specifying that the S-Function block has dynamically sized inputs, the same S-function can accommodate both situations. The Simulink engine automatically calls the block with the appropriately sized input vector. Similarly, if other block characteristics, such as the number of outputs or the number of discrete or continuous states, are specified as dynamically sized, the engine defines these vectors to be the same length as the input vector.

See “Input and Output Ports” on page 8-18 for more information on configuring S-function input and output ports.

Setting Sample Times and Offsets

Both Level-2 MATLAB and C MEX S-functions provide the following sample time options, which allow for a high degree of flexibility in specifying when an S-function executes:

- Continuous sample time — For S-functions that have continuous states and/or nonsampled zero crossings (see “Simulating Dynamic Systems” for an explanation of zero crossings). For this type of S-function, the output changes in minor time steps.
- Continuous, but fixed in minor time step sample time — For S-functions that need to execute at every major simulation step, but do not change value during minor time steps.
- Discrete sample time — If the behavior of your S-function is a function of discrete time intervals, you can define a sample time to control when the Simulink engine calls the S-function. You can also define an offset that delays each sample time hit. The value of the offset cannot exceed the corresponding sample time.

A sample time hit occurs at time values determined by the formula

$$\text{TimeHit} = (n * \text{period}) + \text{offset}$$

where the integer n is the current simulation step. The first value of n is always zero.

If you define a discrete sample time, the engine calls the S-function `mdlOutputs` and `mdlUpdate` routines at each sample time hit (as defined in the previous equation).

- Variable sample time — A discrete sample time where the intervals between sample hits can vary. At the start of each simulation step, S-functions with variable sample times are queried for the time of the next hit.
- Inherited sample time — Sometimes an S-function has no inherent sample time characteristics (that is, it is either continuous or discrete, depending on the sample time of some other block in the system). In this case, you can specify that the sample time is *inherited*. A simple example of this is a Gain block that inherits its sample time from the block driving it.

An S-function can inherit its sample time from

- The driving block
- The destination block
- The fastest sample time in the system

To specify an S-function sample time is inherited, use `-1` in Level-2 MATLAB S-functions and `INHERITED_SAMPLE_TIME` in C MEX S-functions as the sample time. For more information on the propagation of sample times, see “How Propagation Affects Inherited Sample Times” in the *Simulink User’s Guide*.

S-functions can be either single or multirate; a multirate S-function has multiple sample times.

Sample times are specified in pairs in this format: `[sample_time, offset_time]`.

Valid C MEX S-Function Sample Times

The valid sample time pairs for a C MEX S-function are

```
[CONTINUOUS_SAMPLE_TIME, 0.0]
[CONTINUOUS_SAMPLE_TIME, FIXED_IN_MINOR_STEP_OFFSET]
[discrete_sample_time_period, offset]
[VARIABLE_SAMPLE_TIME, 0.0]
```

where

```
CONTINUOUS_SAMPLE_TIME = 0.0
FIXED_IN_MINOR_STEP_OFFSET = 1.0
VARIABLE_SAMPLE_TIME = -2.0
```

and variable names in italics indicate that a real value is required.

Alternatively, you can specify that the sample time is inherited from the driving block. In this case, the C MEX S-function has only one sample time pair, either

```
[INHERITED_SAMPLE_TIME, 0.0]
```

or

```
[INHERITED_SAMPLE_TIME, FIXED_IN_MINOR_STEP_OFFSET]
```

where

```
INHERITED_SAMPLE_TIME = -1.0
```

Valid Level-2 MATLAB S-Function Sample Times

The valid sample time pairs for a Level-2 MATLAB S-function are

```
[0 offset] % Continuous sample time
[discrete_sample_time_period, offset] % Discrete sample time
[-1, 0] % Inherited sample time
[-2, 0] % Variable sample time
```

where variable names in italics indicate that a real value is required. When using a continuous sample time, an *offset* of 1 indicates the output is fixed in minor integration time steps. An *offset* of 0 indicates the output changes at every minor integration time step.

Guidelines for Choosing a Sample Time

Use the following guidelines for help with specifying sample times:

- A continuous S-function that changes during minor integration steps should register the `[CONTINUOUS_SAMPLE_TIME, 0.0]` sample time.
- A continuous S-function that does not change during minor integration steps should register the `[CONTINUOUS_SAMPLE_TIME, FIXED_IN_MINOR_STEP_OFFSET]` sample time.
- A discrete S-function that changes at a specified rate should register the discrete sample time pair, `[discrete_sample_time_period, offset]`, where

$$discrete_sample_period > 0.0$$

and

$$0.0 \quad offset < discrete_sample_period$$

- A discrete S-function that changes at a variable rate should register the variable-step discrete sample time.

`[VARIABLE_SAMPLE_TIME, 0.0]`

In a C MEX S-function, the `mdlGetTimeOfNextVarHit` routine is called to get the time of the next sample hit for the variable-step discrete task. In a Level-2 MATLAB S-function, the `NextTimeHit` property is set in the `Outputs` method to set the next sample hit.

If your S-function has no intrinsic sample time, you must indicate that your sample time is inherited. There are two cases:

- An S-function that changes as its input changes, even during minor integration steps, should register the `[INHERITED_SAMPLE_TIME, 0.0]` sample time.
- An S-function that changes as its input changes, but does not change during minor integration steps (that is, remains fixed during minor time steps), should register the `[INHERITED_SAMPLE_TIME, FIXED_IN_MINOR_STEP_OFFSET]` sample time.

The Scope block is a good example of this type of block. This block runs at the rate of its driving block, either continuous or discrete, but never runs in minor steps. If it did, the scope display would show the intermediate computations of the solver rather than the final result at each time point.

See “Sample Times” on page 8-32 for information on implementing different types of sample times in S-functions.

S-Function Examples

In this section...
“Overview of Examples” on page 1-27
“Level-2 MATLAB S-Function Examples” on page 1-30
“Level-1 MATLAB S-Function Examples” on page 1-30
“C S-Function Examples” on page 1-32
“Fortran S-Function Examples” on page 1-36
“C++ S-Function Examples” on page 1-37

Overview of Examples

To run an example:

- 1 In the MATLAB Command Window, enter `sfundemos`.

The S-function example library opens.

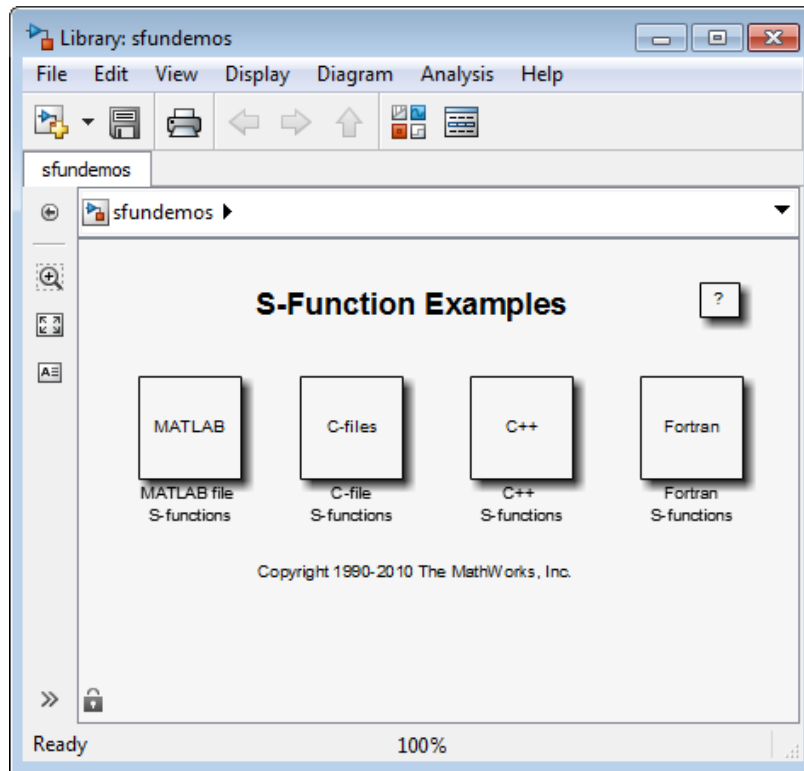

Each block represents a category of S-function examples.

- 2 Double-click a category to display the examples that it includes. For example, click **C-files**.

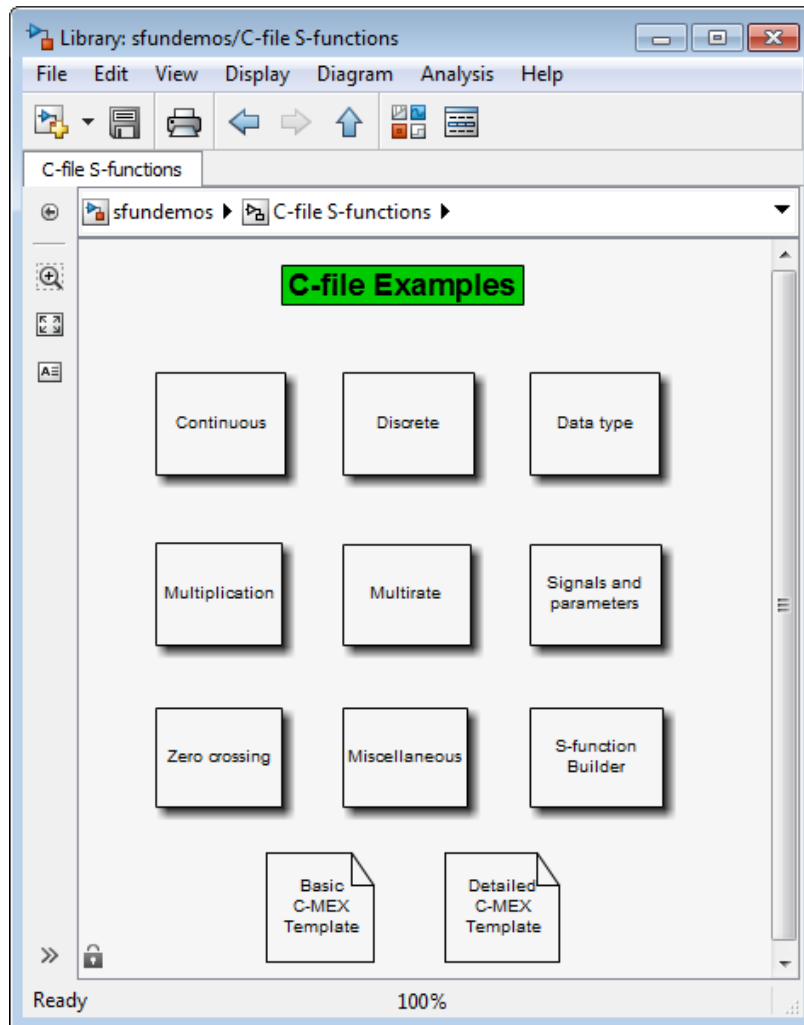

- 3 Double-click a block to open and run the example that it represents.

It might be helpful to examine some sample S-functions as you read the next chapters. Code for the examples is stored in the following folder under the MATLAB root folder.

MATLAB code `toolbox/simulink/simdemos/simfeatures`
 C, C++, and Fortran code `toolbox/simulink/simdemos/simfeatures/src`

Level-2 MATLAB S-Function Examples

The `matlabroot/toolbox/simulink/simdemos/simfeatures` folder contains many Level-2 MATLAB S-functions. Consider starting off by looking at these files.

Filename	Model Name	Description
<code>msfcn_dsc.m</code>	<code>msfcndemo_sfundsc1</code>	Implement an S-function with an inherited sample time.
<code>msfcn_limintm.m</code>	<code>msfcndemo_limintm</code>	Implement a continuous limited integrator where the output is bounded by lower and upper bounds and includes initial conditions.
<code>msfcn_multirate.m</code>	<code>msfcndemo_multirate</code>	Implement a multirate system.
<code>msfcn_times_two.m</code>	<code>msfcndemo_timestwo</code>	Implement an S-function that doubles its input.
<code>msfcn_unit_delay.m</code>	<code>msfcndemo_sfundsc2</code>	Implement a unit delay.
<code>msfcn_varpulse.m</code>	<code>msfcndemo_varpulse</code>	Implement a variable pulse width generator by calling <code>set_param</code> from within a Level-2 MATLAB S-function. Also demonstrates how to use custom set and get methods for the block <code>SimState</code> .
<code>msfcn_vs.m</code>	<code>msfcndemo_vsfunc</code>	Implement a variable sample time block in which the first input is delayed by an amount of time determined by the second input.

Level-1 MATLAB S-Function Examples

The `matlabroot/toolbox/simulink/simdemos/simfeatures` folder also contains many Level-1 MATLAB S-functions, provided as reference for legacy

models. Most of these Level-1 MATLAB S-functions do not have associated example models.

Filename	Description
csfunc.m	Define a continuous system in state-space format.
dsfunc.m	Define a discrete system in state-space format.
limintm.m	Implement a continuous limited integrator where the output is bounded by lower and upper bounds and includes initial conditions.
mixedm.m	Implement a hybrid system consisting of a continuous integrator in series with a unit delay.
sfun_varargm.m	Implement an S-function that shows how to use the MATLAB command <code>varargin</code> .
vsfunc.m	Illustrate how to create a variable sample time block. This S-function implements a variable step delay in which the first input is delayed by an amount of time determined by the second input.

C S-Function Examples

The `matlabroot/toolbox/simulink/simdemos/simfeatures/src` folder contains examples of C MEX S-functions, many of which have a MATLAB S-function counterpart. The C MEX S-functions are listed in the following table.

Filename	Model Name	Description
<code>barplot.c</code>	<code>sfcndemo_barplot</code>	Access Simulink signals without using the standard block inputs.
<code>csfunc.c</code>	<code>sfcndemo_csfunc</code>	Implement a continuous system.
<code>dlimintc.c</code>	No model available	Implement a discrete-time limited integrator.
<code>dsfunc.c</code>	<code>sfcndemo_dsfunc</code>	Implement a discrete system.
<code>limintc.c</code>	No model available	Implement a limited integrator.
<code>mixedm.c</code>	<code>sfcndemo_mixedm</code>	Implement a hybrid dynamic system consisting of a continuous integrator (1/s) in series with a unit delay (1/z).
<code>mixedmex.c</code>	<code>sfcndemo_mixedmex</code>	Implement a hybrid dynamic system with a single output and two inputs.
<code>slexQuantizeSFcn.c</code>	<code>sfcndemo_sfun_quantize</code>	Implement a vectorized quantizer. Quantizes the input into steps as specified by the quantization interval parameter, <code>q</code> .
<code>sdotproduct.c</code>	<code>sfcndemo_sdotproduct</code>	Compute dot product (multiply-accumulate) of two real or complex vectors.
<code>sfbuilder_bususage.c</code>	<code>sfbuilder_bususage</code>	Access S-Function Builder with a bus input and output.
<code>sftable2.c</code>	No model available	Implement a two-dimensional table lookup.
<code>sfun_atol.c</code>	<code>sfcndemo_sfun_atol</code>	Set different absolute tolerances for each continuous state.

Filename	Model Name	Description
sfun_cplx.c	sfcndemo_cplx	Add complex data for an S-function with one input port and one parameter.
sfun_directlook.c	No model available	Implement a direct 1-D lookup.
sfun_dtype_io.c	sfcndemo_dtype_io	Implement an S-function that uses Simulink data types for inputs and outputs.
sfun_dtype_param.c	sfcndemo_dtype_param	Implement an S-function that uses Simulink data types for parameters.
sfun_dynsize.c	sfcndemo_sfun_dynsize	Implements dynamically-sized outputs .
sfun_errhdl.c	sfcndemo_sfun_errhdl	Check parameters using the mdlCheckParameters S-function routine.
sfun_fcncall.c	sfcndemo_sfun_fcncall	Execute function-call subsystems on the first and second output elements.
sfun_frmad.c	sfcndemo_frame	Implement a frame-based A/D converter.
sfun_frmda.c	sfcndemo_frame	Implement a frame-based D/A converter.
sfun_frmdft.c	sfcndemo_frame	Implement a multichannel frame-based Discrete-Fourier transformation (and its inverse).
sfun_frmunbuff.c	sfcndemo_frame	Implement a frame-based unbuffer block.
sfun_multiport.c	sfcndemo_sfun_multiport	Configure multiple input and output ports.
sfun_manswitch.c	No model available	Implement a manual switch.
sfun_matadd.c	sfcndemo_matadd	Add matrices in an S-function with one input port, one output port, and one parameter.
sfun_multirate.c	sfcndemo_sfun_multirate	Demonstrate how to specify port-based sample times.
sfun_port_constant.c	sfcndemo_port_constant	Demonstrate how to specify constant port-based sample times.

Filename	Model Name	Description
sfun_port_triggered.c	sfcndemo_port_triggered	Demonstrate how to use port-based sample times in a triggered subsystem.
sfun_runtime1.c	sfcndemo_runtime	Implement run-time parameters for all tunable parameters.
sfun_runtime2.c	sfcndemo_runtime	Register individual run-time parameters.
sfun_runtime3.c	sfcndemo_runtime	Register dialog parameters as run-time parameters.
sfun_runtime4.c	sfcndemo_runtime	Implement run-time parameters as a function of multiple dialog parameters.
sfun_simstate.c	sfcndemo_sfun_simstate	Demonstrate the S-function API for saving and restoring the SimState.
sfun_zc.c	sfcndemo_sfun_zc	Demonstrate use of nonsampled zero crossings to implement $\text{abs}(u)$. This S-function is designed to be used with a variable-step solver.
sfun_zc_sat.c	sfcndemo_sfun_zc_sat	Demonstrate zero crossings with saturation.
sfunmem.c	sfcndemo_sfunmem	Implement a one-integration-step delay and hold memory function.
simomex.c	sfcndemo_simomex	<p>Implement a single-input, two-output state-space dynamic system described by the state-space equations:</p> $\begin{aligned} dx/dt &= Ax + Bu \\ y &= Cx + Du \end{aligned}$ <p>where x is the state vector, u is vector of inputs, and y is the vector of outputs.</p>

Filename	Model Name	Description
stspace.c	sfcndemo_stspace	Implement a set of state-space equations. You can turn this into a new block by using the S-Function block and mask facility. This example MEX file performs the same function as the built-in State-Space block. This is an example of a MEX file where the number of inputs, outputs, and states is dependent on the parameters passed in from the workspace.
stvctf.c	sfcndemo_stvctf	Implement a continuous-time transfer function whose transfer function polynomials are passed in via the input vector. This is useful for continuous time adaptive control applications.
stvdtf.c	sfcndemo_stvdtf	Implement a discrete-time transfer function whose transfer function polynomials are passed in via the input vector. This is useful for discrete-time adaptive control applications.
stvmgain.c	sfcndemo_stvmgain	Implement a time-varying matrix gain.
table3.c	No model available	Implement a 3-D lookup table.
timestwo.c	sfcndemo_timestwo	Implement a C MEX S-function that doubles its input.
vdlmintc.c	No model available	Implement a discrete-time vectorized limited integrator.
vdpmex.c	sfcndemo_vdpmex	Implement the Van der Pol equation.

Filename	Model Name	Description
vlimintc.c	No model available	Implement a vectorized limited integrator.
vfunc.c	sfcndemo_vfunc	Illustrate how to create a variable sample time block. This block implements a variable-step delay in which the first input is delayed by an amount of time determined by the second input.

Fortran S-Function Examples

The following table lists sample Fortran S-functions available in the *matlabroot/toolbox/simulink/simdemos/simfeatures/src* folder.

Filename	Model Name	Description
sfun_timestwo_for.F	sfcndemo_timestwo_for	Implement a Level-1 Fortran S-function that represents the <i>timestwo.c</i> S-function.
sfun_atmos.c sfun_atmos_sub.F	sfcndemo_atmos	Calculate the 1976 standard atmosphere to 86 km using a Fortran subroutine.

C++ S-Function Examples

The following table lists sample C++ S-functions available in the *matlabroot/toolbox/simulink/simdemos/simfeatures/src* folder.

Filename	Model Name	Description
<code>sfun_counter_cpp.cpp</code>	<code>sfcndemo_counter_cpp</code>	Store a C++ object in the pointers vector PWork.

Selecting an S-Function Implementation

- “Available S-Function Implementations” on page 2-2
- “S-Function Types” on page 2-3
- “Implement S-Functions” on page 2-5
- “S-Function Features” on page 2-8
- “S-Function Limitations” on page 2-12
- “S-Functions Incorporate Legacy C Code” on page 2-14

Available S-Function Implementations

You can implement your S-function in one of five ways:

- **A Level-1 MATLAB S-function** provides a simple MATLAB interface to interact with a small portion of the S-function API. Level-2 MATLAB S-functions supersede Level-1 MATLAB S-functions.
- **A Level-2 MATLAB S-function** provides access to a more extensive set of the S-function API and supports code generation. In most cases, use a Level-2 MATLAB S-function when you want to implement your S-function in MATLAB.
- **A handwritten C MEX S-function** provides the most programming flexibility. You can implement your algorithm as a C MEX S-function or write a wrapper S-function to call existing C, C++, or Fortran code. Writing a new S-function requires knowledge of the S-function API and, if you want to generate inlined code for the S-function, the Target Language Compiler (TLC).
- **The S-Function Builder** is a graphical user interface for programming a subset of S-function functionality. If you are new to writing C MEX S-functions, you can use the S-Function Builder to generate new S-functions or incorporate existing C or C++ code without interacting with the S-function API. The S-Function Builder can also generate TLC files for inlining your S-function during code generation with the Simulink Coder product.
- **The Legacy Code Tool** is a set of MATLAB commands that helps you create an S-function to incorporate legacy C or C++ code. Like the S-Function Builder, the Legacy Code Tool can generate a TLC file to inline your S-function during code generation. The Legacy Code Tool provides access to fewer of the methods in the S-function API than the S-Function Builder or a handwritten C MEX S-function.

The following sections describe the uses, features, and differences of these S-function implementations. The last section compares using a handwritten C MEX S-function, the S-Function Builder, and the Legacy Code Tool to incorporate an existing C function into your Simulink model.

S-Function Types

Consider the following questions if you are unclear about what type of S-function is best for your application.

If you...	Then use...
Are a MATLAB programmer with little or no C programming experience	A Level-2 MATLAB S-function, especially if you do not need to generate code for a model containing the S-function (see “Write Level-2 MATLAB S-Functions” on page 3-4).
Need to generate code for a model containing the S-function	Either a Level-2 MATLAB S-function or a C MEX S-functions. Level-2 MATLAB S-functions require that you write a Target Language Compiler (TLC) file for your S-function, before generating code. C MEX S-functions, however, automatically support code generation.
Need the simulation to run faster	A C MEX S-function, even if you do not need to generate code (see “Creating C MEX S-Functions” on page 4-3). For complicated systems, Level-2 MATLAB S-functions simulate slower than C MEX S-functions because they call out to the MATLAB interpreter.
Need to implement the S-function in C, but have no previous experience writing C MEX S-functions	The S-Function Builder.
Are incorporating legacy code into the model	Any S-function, with the exception of a Level-1 MATLAB S-function. Consider using the Legacy Code Tool if your legacy function calculates only outputs, not dynamic states (see “Integrate C Functions Using Legacy Code Tool” on page 4-55). Otherwise, consider using the S-Function Builder. If you need to call the legacy code during simulation,

If you...	Then use...
	do not use a Level-2 MATLAB S-function because they call legacy code only through their TLC files.
Need to generate embeddable code for an S-function that incorporates legacy code	The Legacy Code Tool if your legacy function calculates only outputs. Otherwise, use a handwritten C MEX S-function or the S-Function Builder.

Implement S-Functions

The following table gives an overview of how to write different types of S-functions. See the associated sections of the S-function documentation for more details on how to implement S-functions using a particular method.

Note For backward compatibility, the following table and sections contain information about Level-1 MATLAB S-functions. However, use the Level-2 MATLAB S-function API to develop new MATLAB S-functions.

S-Function Type	Implementation
Level-1 MATLAB S-function	Use the following template to write a new Level-1 MATLAB S-function: <code>sfuntmpl.m</code> See “Maintain Level-1 MATLAB S-Functions” on page 3-14 for more information.
Level-2 MATLAB S-function	<ol style="list-style-type: none"> <li data-bbox="417 864 1320 1013"> 1 Use the <code>msfuntmpl_basic.m</code> template to write a new Level-2 MATLAB S-function: See “Write Level-2 MATLAB S-Functions” on page 3-4 for more information. <li data-bbox="417 1046 1320 1204"> 2 Write a Target Language Compiler (TLC) file for the S-function if you need to generate code for a model containing the S-function. The file, <code>msfcn_times_two.tlc</code> in the folder is an example TLC file for the S-function <code>msfcn_times_two.m</code>. See “Inline MATLAB File S-Functions” for information on writing TLC files for Level-2 MATLAB S-functions.

S-Function Type	Implementation
Hand-written C MEX S-function	<p>1 Use the <code>sfuntmpl_doc.c</code> template to write a new C MEX S-function (see “Basic C MEX S-Function” on page 4-43) or to write a wrapper S-function that calls C, C++, or Fortran code.</p> <p>For information on writing wrapper S-functions to incorporate legacy C or C++ code, see “Write Wrapper S-Functions”. For information on writing a wrapper function to incorporate legacy Fortran code, see “Constructing the Gateway” on page 6-13.</p> <p>2 Compile the S-function using the <code>mex</code> command to obtain an executable to use during simulation.</p> <p>3 Write a TLC file for the S-function if you want to inline the code during code generation (see “Write Fully Inlined S-Functions with mdlRTW Routine” and “Introduction to the Target Language Compiler”). You do not need a TLC file if you are not inlining the S-function in the generated code.</p>
S-Function Builder	<p>1 Enter the S-function attributes into the S-Function Builder dialog box (see “S-Function Builder Dialog Box” on page 4-12).</p> <p>2 Select the Generate wrapper TLC option to generate a TLC file to inline the S-function during code generation.</p> <p>3 Click Build to generate the S-function, TLC file, and an executable file to use during simulation.</p>
Legacy Code Tool	<p>Use the <code>legacy_code</code> function to perform the following steps (see “Integrate C Functions Using Legacy Code Tool” on page 4-55):</p> <p>1 Initialize a data structure that describes the S-function attributes in terms of the legacy function.</p> <pre>lct_spec = legacy_code('initialize');</pre> <p>2 Generate and compile the wrapper S-function.</p> <pre>legacy_code('sfcn_cmex_generate', lct_spec);</pre>

S-Function Type	Implementation
	<pre>legacy_code('compile', lct_spec);</pre> <p>3 Instantiate an S-Function block that calls the S-function wrapper.</p> <pre>legacy_code('slblock_generate', lct_spec);</pre> <p>4 Generate a TLC file to inline the S-function during code generation.</p> <pre>legacy_code('sfcn_tlc_generate', lct_spec);</pre>

S-Function Features

The following tables give overviews of the features supported by different types of S-functions. The first table focuses on handwritten S-functions. The second table compares the features of S-functions automatically generated by the S-Function Builder or Legacy Code Tool.

Features of Hand-Written S-Functions

Feature	Level-1 MATLAB S-Function	Level-2 MATLAB S-Function	Handwritten C MEX S-Function
Data types	Supports signals with a data type of double.	Supports any data type supported by Simulink software, including fixed-point types.	Supports any data type supported by Simulink software, including fixed-point types.
Numeric types	Supports only real signals.	Supports real and complex signals.	Supports real and complex signals.
Frame support	Does not support frame-based signals.	Supports framed and unframed signals.	Supports framed and unframed signals.
Port dimensions	Supports vector inputs and outputs. Does not support multiple input and output ports.	Supports scalar, 1-D, and multidimensional input and output signals.	Supports scalar, 1-D, and multidimensional input and output signals.
S-function API	Supports only mdlInitializeSizes, mdlDerivatives, mdlUpdate, mdlOutputs, mdlGetTimeOfNextVarHit, and mdlTerminate.	Supports a larger set of the S-function API. See “Level-2 MATLAB S-Function Callback Methods” on page 3-6 for a list of supported methods.	Supports the entire S-function API.
Code generation support	Does not support code generation.	Requires a handwritten TLC file to generate code.	Natively supports code generation. Requires a handwritten TLC file to inline the S-function during code generation.

Features of Hand-Written S-Functions (Continued)

Feature	Level-1 MATLAB S-Function	Level-2 MATLAB S-Function	Handwritten C MEX S-Function
Simulink Accelerator mode	Runs interpretively and is, therefore, not accelerated.	Provides the option to use a TLC file in Accelerator mode, instead of running interpretively.	Provides the option to use a TLC or MEX file in Accelerator mode.
Model reference	Cannot be used in a referenced model.	Supports Normal and Accelerator mode simulations when used in a referenced model. Requires a TLC file for Accelerator mode.	Provides options for sample time inheritance and Normal mode support when used in a referenced model. See “Model Referencing Limitations”
Simulink.AliasType and Simulink.NumericType support	Does not support these classes.	Supports Simulink.NumericType and Simulink.AliasType classes (see “Custom Data Types” on page 8-28).	Supports all of these classes (see “Custom Data Types” on page 8-28).
Bus input and output signals	Does not support bus input or output signals.	Does not support bus input or output signals.	Supports non-virtual bus input or output signals.
Tunable and run-time parameters	Supports tunable parameters during simulation. Does not support run-time parameters.	Supports tunable and run-time parameters.	Supports tunable and run-time parameters.
Work vectors	Does not support work vectors.	Supports DWork vectors (see “Using DWork Vectors in Level-2 MATLAB S-Functions” on page 7-12).	Supports all work vector types (see “Types of DWork Vectors” on page 7-5).

Features of Automatically Generated S-Functions

Feature	S-Function Builder	Legacy Code Tool
Data types	Supports any data type supported by Simulink software, including fixed-point types.	Supports all built-in data types. To use a fixed-point data type, you must specify the data type as a <code>Simulink.NumericType</code> . You cannot use a fixed-point type with unspecified scaling.
Numeric types	Supports real and complex signals.	Supports complex signals only for built-in data types.
Frame support	Supports framed and unframed signals.	Does not support frame-based signals.
Port dimensions	Supports scalar, 1-D, and multidimensional input and output signals.	Supports scalar, 1-D, and multidimensional input and output signals.
S-function API	Supports creation of custom <code>mdlInitializeSizes</code> , <code>mdlInitializeSampleTimes</code> , <code>mdlDerivatives</code> , <code>mdlUpdate</code> , and <code>mdlOutputs</code> . Also allows for automatic generation of <code>mdlStart</code> and <code>mdlTerminate</code> .	Supports <code>mdlInitializeSizes</code> , <code>mdlInitializeSampleTimes</code> , <code>mdlStart</code> , <code>mdlInitializeConditions</code> , <code>mdlOutputs</code> , and <code>mdlTerminate</code> .
Code generation support	Natively supports code generation. Also, automatically generates a TLC file for inlining the S-function during code generation.	Natively supports code generation optimized for embedded systems. Also, automatically generates a TLC file that supports expression folding for inlining the S-function during code generation.
Simulink Accelerator™ mode	Uses a TLC file in Accelerator mode, if the file was generated. Otherwise, uses the MEX file.	Provides the option to use a TLC or MEX file in Accelerator mode.
Model reference	Uses default behaviors when used in a referenced model.	Uses default behaviors when used in a referenced model.

Features of Automatically Generated S-Functions (Continued)

Feature	S-Function Builder	Legacy Code Tool
Simulink.AliasType and Simulink.NumericType	Does not support these classes.	Supports Simulink.AliasType and Simulink.NumericType.
Bus input and output signals	Supports bus input and output signals. See <code>sfbuilder_bususage</code> for an example.	Supports bus input and output signals. You must define a Simulink.Bus object in the MATLAB workspace that is equivalent to the structure of the input or output used in the legacy code. Does not support bus parameters.
Tunable and run-time parameters	Supports tunable parameters only during simulation. Supports run-time parameters.	Supports tunable and run-time parameters.
Work vectors	Does not provide access to work vectors.	Supports DWork vectors with the usage type <code>SS_DWORK_USED_AS_DWORK</code> . See “Types of DWork Vectors” on page 7-5 for a discussion on the different DWork vector usage types.

S-Function Limitations

The following table summarizes the major limitations of the different types of S-functions.

Implementation	Limitations
Level-1 MATLAB S-function	Does not support the majority of S-function features. See the “S-Function Features” on page 2-8 section for information on what features a Level-1 MATLAB S-function does support.
Level-2 MATLAB S-functions	<ul style="list-style-type: none"> • Does not support bus input and output signals. • Cannot incorporate legacy code during simulation, only during code generation through a TLC file.
Handwritten C MEX S-function	Supports model referencing with some limitations. See “S-Functions with Model Referencing” and S-Function Limitations in “Model Referencing Limitations”.
S-Function Builder	<ul style="list-style-type: none"> • Generates S-function code using a wrapper function which incurs additional overhead. • Does not support the following S-function features: <ul style="list-style-type: none"> ▪ Work vectors ▪ Port-based sample times ▪ Multiple sample times or a nonzero offset time ▪ Dynamically-sized input and output signals for an S-function with multiple input and output ports <hr/> <p>Note S-functions with one input and one output port can have dynamically-sized signals</p> <hr/>
Legacy Code Tool	<ul style="list-style-type: none"> • Generates C MEX S-functions for existing functions written in C or C++ only. The tool does not support transformation of MATLAB or Fortran functions. • Can interface with C++ functions, but not C++ objects. • Does not support simulating continuous or discrete states.

Implementation	Limitations
	<ul style="list-style-type: none">• Does not support use of function pointers as the output of the legacy function being called.• Always sets the S-function's flag for direct feedthrough (<code>sizes.DirFeedthrough</code>) to <code>true</code>.• Supports only the continuous, but fixed in minor time step, sample time and offset option.• Supports complex numbers, but only with Simulink built-in data types.• Does not support the following S-function features:<ul style="list-style-type: none">▪ Work vectors, other than general DWork vectors▪ Frame-based input and output signals▪ Port-based sample times▪ Multiple block-based sample times

S-Functions Incorporate Legacy C Code

In this section...

“Overview” on page 2-14

“Using a Hand-Written S-Function to Incorporate Legacy Code” on page 2-15

“Using the S-Function Builder to Incorporate Legacy Code” on page 2-17

“Using the Legacy Code Tool to Incorporate Legacy Code” on page 2-22

Overview

C MEX S-functions allow you to call existing C code within your Simulink models. For example, consider the simple C function `doubleIt.c` that outputs a value two times the value of the function input.

```
double doubleIt(double u)
{
    return(u * 2.0);
}
```

You can create an S-function that calls `doubleIt.c` by either:

- Writing a wrapper S-function. Using this method, you hand write a new C S-function and associated TLC file. This method requires the most knowledge about the structure of a C S-function.
- Using an S-Function Builder block. Using this method, you enter the characteristics of the S-function into a block dialog. This method does not require any knowledge about writing S-functions. However, a basic understanding of the structure of an S-function can make the S-Function Builder dialog box easier to use.
- Using the Legacy Code Tool. Using this command line method, you define the characteristics of your S-function in a data structure in the MATLAB workspace. This method requires the least amount of knowledge about S-functions.

The following sections describe how to create S-functions for use in a Simulink simulation and with Simulink Coder code generation, using the previous three

methods. The model `sfcndemo_choosing_sfun` contains blocks that use these S-functions. Copy this model and the files `doubleIt.c` and `doubleIt.h` from the folder `docroot/toolbox/simulink/sfg/examples` into your working folder if you plan to step through the examples.

Demonstration model for choosing an S-function implementation to incorporate legacy C code.

Click on the file names to copy them into your working directory then follow each block's instructions to generate MEX-files:

[doubleIt.c](#)
[doubleIt.h](#)
[wrapsfcn.c](#)
[lct_wrapsfcn.m](#)

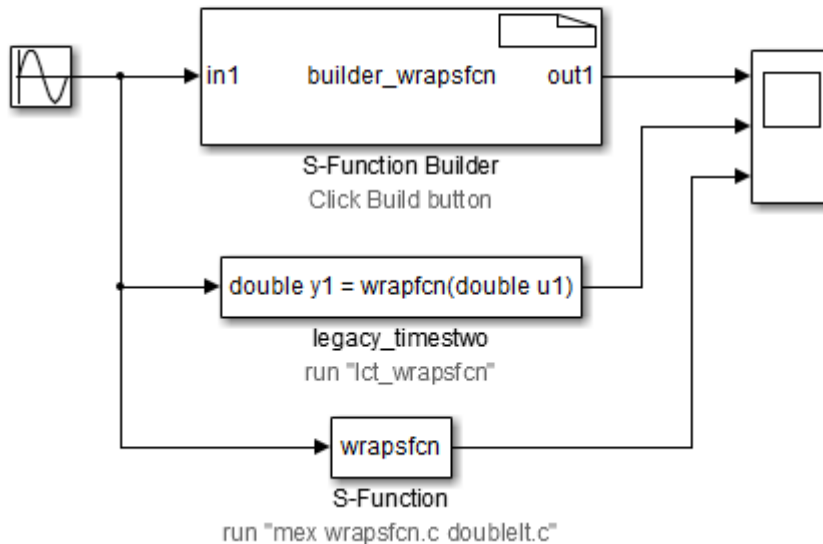

Using a Hand-Written S-Function to Incorporate Legacy Code

The S-function `wrapsfcn.c` calls the legacy function `doubleIt.c` in its `mdlOutputs` method. Save the `wrapsfcn.c` file into your working folder, if you are planning to compile the S-function to run in the example model `sfcndemo_choosing_sfun`.

To incorporate the legacy code into the S-function, `wrapsfcn.c` begins by declaring `doubleIt.c` with the following line:

```
extern real_T doubleIt(real_T u);
```

Once declared, the S-function can use `doubleIt.c` in its `mdlOutputs` method. For example:

```
/* Function: mdlOutputs =====
 * Abstract:
 *   Calls the doubleIt.c function to multiple the input by 2.
 */
static void mdlOutputs(SimStruct *S, int tid){
    InputRealPtrsType uPtrs = ssGetInputPortRealSignalPtrs(S,0);
    real_T          *y      = ssGetOutputPortRealSignal(S,0);

    *y = doubleIt(*uPtrs[0]);
}
```

To compile the `wrapsfcn.c` S-function, run the following `mex` command. Make sure that the `doubleIt.c` file is in your working folder.

```
mex wrapsfcn.c doubleIt.c
```

To generate code for the S-function using the Simulink Coder code generator, you need to write a Target Language Compiler (TLC) file. The following TLC file `wrapsfcn.tlc` uses the `BlockTypeSetup` function to declare a function prototype for `doubleIt.c`. The TLC file's `Outputs` function then tells the Simulink Coder code generator how to inline the call to `doubleIt.c`. For example:

```
%implements "wrapsfcn" "C"
%% File      : wrapsfcn.tlc
%% Abstract:
%%   Example tlc file for S-function wrapsfcn.c
%%

%% Function: BlockTypeSetup =====
%% Abstract:
%%   Create function prototype in model.h as:
%%   "extern double doubleIt(double u);"
```

```

%%

%function BlockTypeSetup(block, system) void
    %openfile buffer

    %% PROVIDE ONE LINE OF CODE AS A FUNCTION PROTOTYPE
    extern double doubleIt(double u);

    %closefile buffer
    %<LibCacheFunctionPrototype(buffer)>
    %%endfunction %% BlockTypeSetup

%% Function: Outputs =====
%% Abstract:
%%     CALL LEGACY FUNCTION: y = doubleIt( u );
%%
%function Outputs(block, system) Output

    /* %<Type> Block: %<Name> */

    %assign u = LibBlockInputSignal(0, "", "", 0)
    %assign y = LibBlockOutputSignal(0, "", "", 0)

    %% PROVIDE THE CALLING STATEMENT FOR "doubleIt"
    %<y> = doubleIt( %<u> );

%endfunction %% Outputs

```

For more information on the TLC, see “Introduction to the Target Language Compiler”.

Using the S-Function Builder to Incorporate Legacy Code

The S-Function Builder automates the creation of S-functions and TLC files that incorporate legacy code. For this example, in addition to `doubleIt.c`, you need the header file `doubleIt.h` that declares the `doubleIt.c` function format, as follows:

```
extern real_T doubleIt(real_T in1);
```

The S-Function Builder block in `sfcdemo_choosing_sfun` shows how to configure the block dialog to call the legacy function `doubleIt.c`. In the S-Function Builder block dialog:

- The **S-function name** field in the **Parameters** pane defines the name `builder_wrapsfcn` for the generated S-function.
- The **Data Properties** pane names the input and output ports as `in1` and `out1`, respectively.
- The **Libraries** pane provides the interface to the legacy code.
 - The **Library/Object/Source files** field contains the source file name `doubleIt.c`.
 - The **Includes** field contains the following line to include the header file that declares the legacy function:

```
#include <doubleIt.h>
```

- The **Outputs** pane calls the legacy function with the lines:

```
/* Call function that multiplies the input by 2 */
```

```
*out1 = doubleIt(*in1);
```

- The **Build Info** pane selects the **Generate wrapper TLC** option.

When you click **Build**, the S-Function Builder generates three files.

File Name	Description
<code>builder_wrapsfcn.c</code>	The main S-function.
<code>builder_wrapsfcn_wrapper.c</code>	A wrapper file containing separate functions for the code entered in the Outputs , Continuous Derivatives , and Discrete Updates panes of the S-Function Builder.
<code>builder_wrapsfcn.tlc</code>	The S-function's TLC file.

The `builder_wrapsfcn.c` file follows a standard format:

- The file begins with a set of `#define` statements that incorporate the information from the S-Function Builder. For example, the following lines define the first input port:

```
#define NUM_INPUTS          1
/* Input Port 0 */
#define IN_PORT_0_NAME     in1
#define INPUT_0_WIDTH      1
#define INPUT_DIMS_0_COL   1
#define INPUT_0_DTYPE      real_T
#define INPUT_0_COMPLEX    COMPLEX_NO
#define IN_0_FRAME_BASED   FRAME_NO
#define IN_0_DIMS          1-D
#define INPUT_0_FEEDTHROUGH 1
```

- Next, the file declares all the wrapper functions found in the `builder_wrapsfcn_wrapper.c` file. This example requires only a wrapper function for the **Outputs** code.

```
extern void builder_wrapsfcn_Outputs_wrapper(const real_T *in1,
                                             real_T *out1);
```

- Following these definitions and declarations, the file contains the S-function methods, such as `mdlInitializeSizes`, that initialize the S-function's input ports, output ports, and parameters. See “Process View” on page 4-76 for a list of methods that are called during the S-function initialization phase.
- The file `mdlOutputs` method calls the `builder_wrapsfcn_wrapper.c` function. The method uses the input and output names `in1` and `out1`, as defined in the **Data Properties** pane, when calling the wrapper function. For example:

```
/* Function: mdlOutputs =====
 *
 */
static void mdlOutputs(SimStruct *S, int_T tid)
{
    const real_T *in1 = (const real_T*) ssGetInputPortSignal(S,0);
```

```
    real_T      *out1 = (real_T *)ssGetOutputPortRealSignal(S,0);

    builder_wrapsfcn_Outputs_wrapper(in1, out1);
}
```

- The file `builder_wrapsfcn.c` concludes with the required `mdlTerminate` method.

The wrapper function `builder_wrapsfcn_wrapper.c` has three parts:

- The **Include Files** section includes the `doubleIt.h` file, along with the standard S-function header files:

```
/*
 * Include Files
 *
 */
#if defined(MATLAB_MEX_FILE)
#include "tmwtypes.h"
#include "simstruc_types.h"
#else
#include "rtwtypes.h"
#endif
/* %%-SFUNWIZ_wrapper_includes_Changes_BEGIN --- EDIT HERE TO _END */
#include <math.h>
#include <doubleIt.h>
/* %%-SFUNWIZ_wrapper_includes_Changes_END --- EDIT HERE TO _BEGIN */
```

- The **External References** section contains information from the **External reference declarations** field on the **Libraries** pane. This example does not use this section.
- The **Output functions** section declares the function `builder_wrapfcn_Outputs_wrapper`, which contains the code entered in the S-Function Builder block dialog's **Outputs** pane:

```
/*
 * Output functions
 *
 */
void builder_wrapfcn_Outputs_wrapper(const real_T *in1,
```



```

        real_T *out1)
    {
        /* %%-SFUNWIZ_wrapper_Outputs_Changes_BEGIN --- EDIT HERE TO _END */
        /* Call function that multiplies the input by 2 */

        *out1 = doubleIt(*in1);
        /* %%-SFUNWIZ_wrapper_Outputs_Changes_END --- EDIT HERE TO _BEGIN */
    }

```

Note Compared to a handwritten S-function, the S-Function Builder places the call to the legacy C function down an additional level through the wrapper file `builder_wrapsfcn_wrapper.c`.

The TLC file `builder_wrapsfcn.tlc` generated by the S-Function Builder is similar to the previous handwritten version. The file declares the legacy function in `BlockTypeSetup` and calls it in the `Outputs` method.

```

implements builder_wrapsfcn "C"
%% Function: BlockTypeSetup =====
%%
%% Purpose:
%%     Set up external references for wrapper functions in the
%%     generated code.
%%
%function BlockTypeSetup(block, system) Output
    %openfile externs

    extern void builder_wrapsfcn_Outputs_wrapper(const real_T *in1,
        real_T *out1);

    %closefile externs
    %<LibCacheExtern(externs)>
    %%
%endfunction

%% Function: Outputs =====
%%
%% Purpose:
%%     Code generation rules for mdlOutputs function.

```

```
%%  
%function Outputs(block, system) Output  
    /* S-Function "builder_wrapsfcn_wrapper" Block: %<Name> */  
  
    %assign pu0 = LibBlockInputSignalAddr(0, "", "", 0)  
    %assign py0 = LibBlockOutputSignalAddr(0, "", "", 0)  
    %assign py_width = LibBlockOutputSignalWidth(0)  
    %assign pu_width = LibBlockInputSignalWidth(0)  
    builder_wrapsfcn_Outputs_wrapper(%<pu0>, %<py0> );  
  
%%  
%endfunction
```

Using the Legacy Code Tool to Incorporate Legacy Code

The section “Example of Integrating Existing C Functions into Simulink Models with the Legacy Code Tool” on page 4-58 in “Writing S-Functions in C” shows how to use the Legacy Code Tool to create an S-function that incorporates `doubleIt.c`. For a script that performs the steps in that example, copy the file `lct_wrapsfcn.m` to your working folder. Make sure that the `doubleIt.c` and `doubleIt.h` files are in your working folder then run the script by typing `lct_wrapsfcn` at the MATLAB command prompt. The script creates and compiles the S-function `legacy_wrapsfcn.c` and creates the TLC file `legacy_wrapsfcn.tlc` via the following commands.

```
% Create the data structure  
def = legacy_code('initialize');  
  
% Populate the data structure  
def.SourceFiles = {'doubleIt.c'};  
def.HeaderFiles = {'doubleIt.h'};  
def.SFunctionName = 'legacy_wrapsfcn';  
def.OutputFcnSpec = 'double y1 = doubleIt(double u1)';  
def.SampleTime = [-1,0];  
  
% Generate the S-function  
legacy_code('sfcn_cmex_generate', def);  
  
% Compile the MEX-file  
legacy_code('compile', def);
```

```
% Generate a TLC-file
legacy_code('sfcn_tlc_generate', def);
```

The S-function `legacy_wrapsfcn.c` generated by the Legacy Code Tool begins by including the `doubleIt.h` header file. The `mdlOutputs` method then directly calls the `doubleIt.c` function, as follows:

```
static void mdlOutputs(SimStruct *S, int_T tid)
{
    /*
     * Get access to Parameter/Input/Output/DWork/size information
     */
    real_T *u1 = (real_T *) ssGetInputPortSignal(S, 0);
    real_T *y1 = (real_T *) ssGetOutputPortSignal(S, 0);

    /*
     * Call the legacy code function
     */
    *y1 = doubleIt( *u1);
}
```

The S-function generated by the Legacy Code Tool differs from the S-function generated by the S-Function Builder as follows:

- The S-function generated by the S-Function Builder calls the legacy function `doubleIt.c` through the wrapper function `builder_wrapsfcn_wrapper.c`. The S-function generated by the Legacy Code Tool directly calls `doubleIt.c` from its `mdlOutputs` method.
- The S-Function Builder uses the input and output names entered into the **Data Properties** pane, allowing you to customize these names in the S-function. The Legacy Code Tool uses the default names `y` and `u` for the outputs and inputs, respectively. You cannot specify customized names to use in the generated S-function when using the Legacy Code Tool.
- The S-Function Builder and Legacy Code Tool both specify an inherited sample time, by default. However, the S-Function Builder uses an offset time of `0.0` while the Legacy Code Tool specifies that the offset time is fixed in minor time steps.

The TLC file `legacy_wrapsfcn.tlc` supports expression folding by defining `BlockInstanceSetup` and `BlockOutputSignal` functions. The TLC file also contains a `BlockTypeSetup` function to declare a function prototype for `doubleIt.c` and an `Outputs` function to tell the Simulink Coder code generator how to inline the call to `doubleIt.c`:

```
%% Function: BlockTypeSetup =====
%%
function BlockTypeSetup(block, system) void
    %%
    %% The Target Language must be C
    %%if ::GenCPP==1
        %<LibReportFatalError("This S-Function generated by the Legacy Code Tool
            must be only used with the C Target Language")>
    %%endif
    %<LibAddToCommonIncludes("doubleIt.h")>
    %<LibAddToModelSources("doubleIt")>
%%
%endfunction

%% Function: BlockInstanceSetup =====
%%
function BlockInstanceSetup(block, system) void
    %%
    %<LibBlockSetIsExpressionCompliant(block)>
    %%
%endfunction

%% Function: Outputs =====
%%
function Outputs(block, system) Output
    %%
    %%if !LibBlockOutputSignalIsExpr(0)
        %assign u1_val = LibBlockInputSignal(0, "", "", 0)
        %assign y1_val = LibBlockOutputSignal(0, "", "", 0)
    %%
    %<y1_val = doubleIt( %<u1_val>);
    %%endif
    %%
%endfunction
```

```
%% Function: BlockOutputSignal =====
%%
%function BlockOutputSignal(block,system,portIdx,ucv,lcv,idx,retType) void
%%
%assign u1_val = LibBlockInputSignal(0, "", "", 0)
%assign y1_val = LibBlockOutputSignal(0, "", "", 0)
%%
%switch retType
%case "Signal"
%if portIdx == 0
%return "doubleIt( %<u1_val>)"
%else
%assign errTxt = "Block output port index not supported: %<portIdx>"
%endif
%default
%assign errTxt = "Unsupported return type: %<retType>"
%<LibBlockReportError(block,errTxt)>
%endswitch
```

Writing S-Functions in MATLAB

- “Introduction” on page 3-2
- “Write Level-2 MATLAB S-Functions” on page 3-4
- “Maintain Level-1 MATLAB S-Functions” on page 3-14

Introduction

You can create custom blocks whose properties and behaviors are defined by MATLAB functions called MATLAB S-functions. The Level-2 MATLAB S-function application programming interface (API) allows you to create blocks that have many of the features and capabilities of Simulink built-in blocks, including:

- Multiple input and output ports
- 1-D, 2-D, and n-D input and output signals
- All data types supported by the Simulink software
- Real or complex signals
- Frame-based signals
- Multiple sample rates
- User-defined data and work vectors
- Tunable and run-time parameters

Note Level-2 MATLAB S-functions do not support zero-crossing detection.

For information on how to write a Level-2 MATLAB S-functions, see “Write Level-2 MATLAB S-Functions” on page 3-4.

If you have Simulink Coder, you can generate code for Level-2 MATLAB S-functions if they are inlined. For more information, see “Inlining S-Functions”.

Note This version of the Simulink software also supports a predecessor API known as the Level-1 MATLAB S-function. This ensures that you can simulate models developed with earlier releases that use Level-1 MATLAB S-functions in their S-Function blocks (see “Maintain Level-1 MATLAB S-Functions” on page 3-14). Level-1 MATLAB S-functions support a much smaller subset of the S-function API than Level-2 MATLAB S-functions, and their features are limited compared to built-in blocks. Use the Level-2 API, not the Level-1 API, to develop new MATLAB S-functions.

Write Level-2 MATLAB S-Functions

In this section...

- “About Level-2 MATLAB S-Functions” on page 3-4
- “About Run-Time Objects” on page 3-5
- “Level-2 MATLAB S-Function Template” on page 3-5
- “Level-2 MATLAB S-Function Callback Methods” on page 3-6
- “Using the setup Method” on page 3-8
- “Example of Writing a Level-2 MATLAB S-Function” on page 3-8
- “Instantiating a Level-2 MATLAB S-Function” on page 3-12
- “Operations for Variable-Size Signals” on page 3-12
- “Generating Code from a Level-2 MATLAB S-Function” on page 3-13
- “MATLAB S-Function Examples” on page 3-13

About Level-2 MATLAB S-Functions

The Level-2 MATLAB S-function API allows you to use the MATLAB language to create custom blocks with multiple input and output ports and capable of handling any type of signal produced by a Simulink model, including matrix and frame signals of any data type. The Level-2 MATLAB S-function API corresponds closely to the API for creating C MEX S-functions. Much of the documentation for creating C MEX S-functions applies also to Level-2 MATLAB S-functions. To avoid duplication, this section focuses on providing information that is specific to writing Level-2 MATLAB S-functions.

A Level-2 MATLAB S-function is MATLAB function that defines the properties and behavior of an instance of a Level-2 MATLAB S-Function block that references the MATLAB function in a Simulink model. The MATLAB function itself comprises a set of callback methods (see “Level-2 MATLAB S-Function Callback Methods” on page 3-6) that the Simulink engine invokes when updating or simulating the model. The callback methods perform the actual work of initializing and computing the outputs of the block defined by the S-function.

To facilitate these tasks, the engine passes a run-time object to the callback methods as an argument. The run-time object effectively serves as a MATLAB proxy for the S-Function block, allowing the callback methods to set and access the block properties during simulation or model updating.

About Run-Time Objects

When the Simulink engine invokes a Level-2 MATLAB S-function callback method, it passes an instance of the `Simulink.MSFcnRunTimeBlock` class to the method as an argument. This instance, known as the run-time object for the S-Function block, serves the same purpose for Level-2 MATLAB S-function callback methods as the `SimStruct` structure serves for C MEX S-function callback methods. The object enables the method to provide and obtain information about various elements of the block ports, parameters, states, and work vectors. The method does this by getting or setting properties or invoking methods of the block run-time object. See the documentation for the `Simulink.MSFcnRunTimeBlock` class for information on getting and setting run-time object properties and invoking run-time object methods.

Run-time objects do not support MATLAB sparse matrices. For example, if the variable `block` is a run-time object, the following line in a Level-2 MATLAB S-function produces an error:

```
block.Outputport(1).Data = speye(10);
```

where the `speye` command forms a sparse identity matrix.

Note Other MATLAB programs besides MATLAB S-functions can use run-time objects to obtain information about a MATLAB S-function in a model that is simulating. See “Access Block Data During Simulation” in *Using Simulink* for more information.

Level-2 MATLAB S-Function Template

Use the basic Level-2 MATLAB S-function template `msfuntmpl_basic.m` to get a head start on creating a new Level-2 MATLAB S-function. The template contains skeleton implementations of the required callback methods defined by the Level-2 MATLAB S-function API. To write a more complicated S-function, use the annotated template `msfuntmpl.m`.

To create a MATLAB S-function, make a copy of the template and edit the copy as necessary to reflect the desired behavior of the S-function you are creating. The following two sections describe the contents of the MATLAB code template. The section “Example of Writing a Level-2 MATLAB S-Function” on page 3-8 describes how to write a Level-2 MATLAB S-function that models a unit delay.

Level-2 MATLAB S-Function Callback Methods

The Level-2 MATLAB S-function API defines the signatures and general purposes of the callback methods that constitute a Level-2 MATLAB S-function. The S-function itself provides the implementations of these callback methods. The implementations in turn determine the block attributes (e.g., ports, parameters, and states) and behavior (e.g., the block outputs as a function of time and the block inputs, states, and parameters). By creating an S-function with an appropriate set of callback methods, you can define a block type that meets the specific requirements of your application.

A Level-2 MATLAB S-function must include the following callback methods:

- A `setup` function to initialize the basic S-function characteristics
- An `Outputs` function to calculate the S-function outputs

Your S-function can contain other methods, depending on the requirements of the block that the S-function defines. The methods defined by the Level-2 MATLAB S-function API generally correspond to similarly named methods defined by the C MEX S-function API. For information on when these methods are called during simulation, see “Process View” on page 4-76 in “Simulink Engine Interaction with C S-Functions” on page 4-76. For instructions on how to implement each callback method, see “Write Callback Methods” on page 4-89.

The following table lists all the Level-2 MATLAB S-function callback methods and their C MEX counterparts.

Level-2 MATLAB Method	Equivalent C MEX Method
setup (see “Using the setup Method” on page 3-8)	mdlInitializeSizes
CheckParameters	mdlCheckParameters
Derivatives	mdlDerivatives
Disable	mdlDisable
Enable	mdlEnable
InitializeConditions	mdlInitializeConditions
Outputs	mdlOutputs
PostPropagationSetup	mdlSetWorkWidths
ProcessParameters	mdlProcessParameters
Projection	mdlProjection
SetInputPortComplexSignal	mdlSetInputPortComplexSignal
SetInputPortDataType	mdlSetInputPortDataType
SetInputPortDimensions	mdlSetInputPortDimensionInfo
SetInputPortDimensionsModeFcn	mdlSetInputPortDimensionsModeFcn
SetInputPortSampleTime	mdlSetInputPortSampleTime
SetInputPortSamplingMode	mdlSetInputPortFrameData
SetOutputPortComplexSignal	mdlSetOutputPortComplexSignal
SetOutputPortDataType	mdlSetOutputPortDataType
SetOutputPortDimensions	mdlSetOutputPortDimensionInfo
SetOutputPortSampleTime	mdlSetOutputPortSampleTime
SimStatusChange	mdlSimStatusChange
Start	mdlStart
Terminate	mdlTerminate
Update	mdlUpdate
WriteRTW	mdlRTW

Using the setup Method

The body of the `setup` method in a Level-2 MATLAB S-function initializes the instance of the corresponding Level-2 MATLAB S-Function block. In this respect, the `setup` method is similar to the `mdlInitializeSizes` and `mdlInitializeSampleTimes` callback methods implemented by C MEX S-functions. The `setup` method performs the following tasks:

- Initializing the number of input and output ports of the block.
- Setting attributes such as dimensions, data types, complexity, and sample times for these ports.
- Specifying the block sample time. See “Specify Sample Time” in *Using Simulink* for more information on how to specify valid sample times.
- Setting the number of S-function dialog parameters.
- Registering S-function callback methods by passing the handles of local functions in the MATLAB S-function to the `RegBlockMethod` method of the S-Function block’s run-time object. See the documentation for `Simulink.MSFcnRunTimeBlock` for information on using the `RegBlockMethod` method.

Example of Writing a Level-2 MATLAB S-Function

The following steps illustrate how to write a simple Level-2 MATLAB S-function. When applicable, the steps include examples from the S-function example `msfcn_unit_delay.m` used in the model `msfcndemo_sfundsc2`. All lines of code use the variable name `block` for the S-function run-time object.

- 1** Copy the Level-2 MATLAB S-function template `msfuntmpl_basic.m` to your working folder. If you change the file name when you copy the file, change the function name in the function line to the same name.
- 2** Modify the `setup` method to initialize the S-function’s attributes. For this example:
 - Set the run-time object’s `NumInputPorts` and `NumOutputPorts` properties to 1 in order to initialize one input port and one output port.
 - Invoke the run-time object’s `SetPreCompInpPortInfoToDynamic` and `SetPreCompOutPortInfoToDynamic` methods to indicate that the

input and output ports inherit their compiled properties (dimensions, data type, complexity, and sampling mode) from the model.

- Set the `DirectFeedthrough` property of the run-time object's `InputPort` to `false` in order to indicate the input port does not have direct feedthrough. Retain the default values for all other input and output port properties that are set in your copy of the template file. The values set for the `Dimensions`, `DatatypeID`, and `Complexity` properties override the values inherited using the `SetPreCompInpPortInfoToDynamic` and `SetPreCompOutPortInfoToDynamic` methods.
- Set the run-time object's `NumDialogPrms` property to 1 in order to initialize one S-function dialog parameter.
- Specify that the S-function has an inherited sample time by setting the value of the runtime object's `SampleTimes` property to `[-1 0]`.
- Call the run-time object's `RegBlockMethod` method to register the following four callback methods used in this S-function.
 - `PostPropagationSetup`
 - `InitializeConditions`
 - `Outputs`
 - `Update`
 Remove any other registered callback methods from your copy of the template file. In the calls to `RegBlockMethod`, the first input argument is the name of the S-function API method and the second input argument is the function handle to the associated local function in the MATLAB S-function.

The following `setup` method from `msfcn_unit_delay.m` performs the previous list of steps:

```
function setup(block)

%% Register a single dialog parameter
block.NumDialogPrms = 1;

%% Register number of input and output ports
block.NumInputPorts = 1;
block.NumOutputPorts = 1;
```

```
%% Setup functional port properties to dynamically
%% inherited.
block.SetPreCompInpPortInfoToDynamic;
block.SetPreCompOutPortInfoToDynamic;

%% Hard-code certain port properties
block.InputPort(1).Dimensions      = 1;
block.InputPort(1).DirectFeedthrough = false;

block.OutputPort(1).Dimensions      = 1;

%% Set block sample time to [0.1 0]
block.SampleTimes = [0.1 0];

%% Register methods
block.RegBlockMethod('PostPropagationSetup',@DoPostPropSetup);
block.RegBlockMethod('InitializeConditions',@InitConditions);
block.RegBlockMethod('Outputs',           @Output);
block.RegBlockMethod('Update',            @Update);
```

If your S-function needs continuous states, initialize the number of continuous states in the setup method using the run-time object's NumContStates property. Do not initialize discrete states in the setup method.

- 3** Initialize the discrete states in the PostPropagationSetup method. A Level-2 MATLAB S-function stores discrete state information in a DWork vector. The default PostPropagationSetup method in the template file suffices for this example.

The following PostPropagationSetup method from `msfcn_unit_delay.m`, named `DoPostPropSetup`, initializes one DWork vector with the name `x0`.

```
function DoPostPropSetup(block)

%% Setup Dwork
block.NumDworks = 1;
block.Dwork(1).Name = 'x0';
block.Dwork(1).Dimensions      = 1;
block.Dwork(1).DatatypeID      = 0;
```



```

block.Dwork(1).Complexity      = 'Real';
block.Dwork(1).UsedAsDiscState = true;

```

If your S-function uses additional DWork vectors, initialize them in the `PostPropagationSetup` method, as well (see “Using DWork Vectors in Level-2 MATLAB S-Functions” on page 7-12).

- 4** Initialize the values of discrete and continuous states or other DWork vectors in the `InitializeConditions` or `Start` callback methods. Use the `Start` callback method for values that are initialized once at the beginning of the simulation. Use the `InitializeConditions` method for values that need to be reinitialized whenever an enabled subsystem containing the S-function is reenabled.

For this example, use the `InitializeConditions` method to set the discrete state’s initial condition to the value of the S-function’s dialog parameter. For example, the `InitializeConditions` method in `msfcn_unit_delay.m` is:

```

function InitConditions(block)

    %% Initialize Dwork
    block.Dwork(1).Data = block.DialogPrm(1).Data;

```

For S-functions with continuous states, use the `ContStates` run-time object method to initialize the continuous state data. For example:

```

block.ContStates.Data(1) = 1.0;

```

- 5** Calculate the S-function’s outputs in the `Outputs` callback method. For this example, set the output to the current value of the discrete state stored in the DWork vector.

The `Outputs` method in `msfcn_unit_delay.m` is:

```

function Output(block)

    block.OutputPort(1).Data = block.Dwork(1).Data;

```

- 6** For an S-function with continuous states, calculate the state derivatives in the `Derivatives` callback method. Run-time objects store derivative data

in their `Derivatives` property. For example, the following line sets the first state derivative equal to the value of the first input signal.

```
block.Derivatives(1).Data = block.InputPort(1).Data;
```

This example does not use continuous states and, therefore, does not implement the `Derivatives` callback method.

- 7 Update any discrete states in the `Update` callback method. For this example, set the value of the discrete state to the current value of the first input signal.

The `Update` method in `msfcn_unit_delay.m` is:

```
function Update(block)

    block.Dwork(1).Data = block.InputPort(1).Data;
```

- 8 Perform any cleanup, such as clearing variables or memory, in the `Terminate` method. Unlike C MEX S-functions, Level-2 MATLAB S-function are not required to have a `Terminate` method.

For information on additional callback methods, see “Level-2 MATLAB S-Function Callback Methods” on page 3-6. For a list of run-time object properties, see the reference page for `Simulink.MSFcnRunTimeBlock` and the parent class `Simulink.RunTimeBlock`.

Instantiating a Level-2 MATLAB S-Function

To use a Level-2 MATLAB S-function in a model, copy an instance of the Level-2 MATLAB S-Functionblock into the model. Open the Block Parameters dialog box for the block and enter the name of the MATLAB file that implements your S-function into the **S-function name** field. If your S-function uses any additional parameters, enter the parameter values as a comma-separated list in the Block Parameters dialog box **Parameters** field.

Operations for Variable-Size Signals

Following are modifications to the Level-2 MATLAB S-functions template (`msfuntmpl_basic.m`) and additional operations that allow you to use variable-size signals.

```

function setup(block)
% Register the properties of the output port
block.OutputPort(1).DimensionsMode = 'Variable';
block.RegBlockMethod('SetInputPortDimensionsMode', @SetInputDimsMode);

function DoPostPropSetup(block)
%Register dependency rules to update current output size of output port a depending on
%input ports b and c
block.AddOutputDimsDependencyRules(a, [b c], @setOutputVarDims);

%Configure output port b to have the same dimensions as input port a
block.InputPortSameDimsAsOutputPort(a,b);

%Configure DWork a to have its size reset when input size changes.
block.DWorkRequireResetForSignalSize(a,true);

function SetInputDimsMode(block, port, dm)
% Set dimension mode
block.InputPort(port).DimensionsMode = dm;
block.OutputPort(port).DimensionsMode = dm;

function setOutputVarDims(block, opIdx, inputIdx)
% Set current (run-time) dimensions of the output
outDimsAfterReset = block.InputPort(inputIdx(1)).CurrentDimensions;
block.OutputPort(opIdx).CurrentDimensions = outDimsAfterReset;

```

Generating Code from a Level-2 MATLAB S-Function

Generating code for a model containing a Level-2 MATLAB S-function requires that you provide a corresponding Target Language Compiler (TLC) file. You do not need a TLC file to accelerate a model containing a Level-2 MATLAB S-function. The Simulink Accelerator software runs Level-2 MATLAB S-functions in interpreted mode. For more information on writing TLC files for MATLAB S-functions, see “Inlining S-Functions”.

MATLAB S-Function Examples

The Level-2 MATLAB S-function examples provide a set of self-documenting models that illustrate the use of Level-2 MATLAB S-functions. Enter `sfundemos` at the MATLAB command prompt to view the examples.

Maintain Level-1 MATLAB S-Functions

In this section...

“About the Maintenance of Level-1 MATLAB S-Functions” on page 3-14

“Level-1 MATLAB S-Function Arguments” on page 3-15

“Level-1 MATLAB S-Function Outputs” on page 3-16

“Define S-Function Block Characteristics” on page 3-17

“Processing S-Function Parameters” on page 3-18

“Convert Level-1 MATLAB S-Functions to Level-2” on page 3-18

About the Maintenance of Level-1 MATLAB S-Functions

Note The information provided in this section is intended only for use in maintaining existing Level-1 MATLAB S-functions. Use the more capable Level-2 API to develop new MATLAB S-functions (see “Write Level-2 MATLAB S-Functions” on page 3-4). Level-1 MATLAB S-functions support a much smaller subset of the S-function API than Level-2 MATLAB S-functions, and their features are limited compared to built-in blocks.

A Level-1 MATLAB S-function is a MATLAB function of the following form

$$[\text{sys}, \text{x0}, \text{str}, \text{ts}] = f(\text{t}, \text{x}, \text{u}, \text{flag}, \text{p1}, \text{p2}, \dots)$$

where f is the name of the S-function. During simulation of a model, the Simulink engine repeatedly invokes f , using the `flag` argument to indicate the task (or tasks) to be performed for a particular invocation. The S-function performs the task and returns the results in an output vector.

A template implementation of a Level-1 MATLAB S-function, `sfuntmpl.m`, resides in `matlabroot/toolbox/simulink/blocks`. The template consists of a top-level function and a set of skeleton local functions, called S-function callback methods, each of which corresponds to a particular value of `flag`. The top-level function invokes the local function indicated by `flag`. The

local functions perform the actual tasks required of the S-function during simulation.

Level-1 MATLAB S-Function Arguments

The Simulink engine passes the following arguments to a Level-1 MATLAB S-function:

t	Current time
x	State vector
u	Input vector
flag	Integer value that indicates the task to be performed by the S-function

The following table describes the values that `flag` can assume and lists the corresponding Level-2 MATLAB S-function method for each value.

Flag Argument

Level-1 Flag	Level-2 Callback Method	Description
0	setup	Defines basic S-Function block characteristics, including sample times, initial conditions of continuous and discrete states, and the <code>sizes</code> array (see “Define S-Function Block Characteristics” on page 3-17 for a description of the <code>sizes</code> array).
1	mdlDerivatives	Calculates the derivatives of the continuous state variables.

Flag Argument (Continued)

Level-1 Flag	Level-2 Callback Method	Description
2	mdlUpdate	Updates discrete states, sample times, and major time step requirements.
3	mdlOutputs	Calculates the outputs of the S-function.
4	mdlOutputs method updates the run-time object NextTimeHit property	Calculates the time of the next hit in absolute time. This routine is used only when you specify a variable discrete-time sample time in the setup method.
9	mdlTerminate	Performs any necessary end-of-simulation tasks.

Level-1 MATLAB S-Function Outputs

A Level-1 MATLAB S-function returns an output vector containing the following elements:

- **sys**, a generic return argument. The values returned depend on the **flag** value. For example, for **flag** = 3, **sys** contains the S-function outputs.
- **x0**, the initial state values (an empty vector if there are no states in the system). **x0** is ignored, except when **flag** = 0.
- **str**, reserved for future use. Level-1 MATLAB S-functions must set this to the empty matrix, **[]**.
- **ts**, a two-column matrix containing the sample times and offsets of the block (see “Specify Sample Time” in *Using Simulink* for information on how to specify a sample times and offsets).

For example, if you want your S-function to run at every time step (continuous sample time), set **ts** to **[0 0]**. If you want your S-function to run at the same rate as the block to which it is connected (inherited

sample time), set `ts` to `[-1 0]`. If you want it to run every 0.25 seconds (discrete sample time) starting at 0.1 seconds after the simulation start time, set `ts` to `[0.25 0.1]`.

You can create S-functions that do multiple tasks, each at a different sample rate (i.e., a multirate S-function). In this case, `ts` should specify all the sample rates used by your S-function in ascending order by sample time. For example, suppose your S-function performs one task every 0.25 second starting from the simulation start time and another task every 1 second starting 0.1 second after the simulation start time. In this case, your S-function should set `ts` equal to `[.25 0; 1.0 .1]`. This will cause the Simulink engine to execute the S-function at the following times: `[0 0.1 0.25 0.5 0.75 1 1.1 ...]`. Your S-function must decide at every sample time which task to perform at that sample time.

You can also create an S-function that performs some tasks continuously (i.e., at every time step) and others at discrete intervals.

Define S-Function Block Characteristics

For the Simulink engine to recognize a Level-1 MATLAB S-function, you must provide it with specific information about the S-function. This information includes the number of inputs, outputs, states, and other block characteristics.

To provide this information, call the `simsizes` function at the beginning of the S-function.

```
sizes = simsizes;
```

This function returns an uninitialized `sizes` structure. You must load the `sizes` structure with information about the S-function. The table below lists the fields of the `sizes` structure and describes the information contained in each field.

Fields in the `sizes` Structure

Field Name	Description
<code>sizes.NumContStates</code>	Number of continuous states
<code>sizes.NumDiscStates</code>	Number of discrete states
<code>sizes.NumOutputs</code>	Number of outputs

Fields in the sizes Structure (Continued)

Field Name	Description
<code>sizes.NumInputs</code>	Number of inputs
<code>sizes.DirFeedthrough</code>	Flag for direct feedthrough
<code>sizes.NumSampleTimes</code>	Number of sample times

After you initialize the `sizes` structure, call `simsizes` again:

```
sys = simsizes(sizes);
```

This passes the information in the `sizes` structure to `sys`, a vector that holds the information for use by the Simulink engine.

Processing S-Function Parameters

When invoking a Level-1 MATLAB S-function, the Simulink engine always passes the standard block parameters, `t`, `x`, `u`, and `flag`, to the S-function as function arguments. The engine can pass additional block-specific parameters specified by the user to the S-function. The user specifies the parameters in the **S-function parameters** field of the S-Function Block Parameters dialog box (see “Passing Parameters to S-Functions” on page 1-5). If the block dialog specifies additional parameters, the engine passes the parameters to the S-function as additional function arguments. The additional arguments follow the standard arguments in the S-function argument list in the order in which the corresponding parameters appear in the block dialog. You can use this block-specific S-function parameter capability to allow the same S-function to implement various processing options. See the `limintm.m` example in the `matlabroot/toolbox/simulink/blocks` folder for an example of an S-function that uses block-specific parameters.

Convert Level-1 MATLAB S-Functions to Level-2

You can convert Level-1 MATLAB S-functions to Level-2 MATLAB S-functions by mapping the code associated with each Level-1 S-function flag to the appropriate Level-2 S-function callback method. See the Flag Arguments table for a mapping of Level-1 flags to Level-2 callback methods. In addition:

- Store discrete state information for Level-2 MATLAB S-functions in `DWork` vectors, initialized in the `PostPropagationSetup` method.
- Access Level-2 MATLAB S-function dialog parameters using the `DialogPrm` run-time object property, instead of passing them into the S-function as function arguments.
- For S-functions with variable sample times, update the `NextTimeHit` run-time object property in the `Outputs` method to set the next sample time hit for the Level-2 MATLAB S-function.

For example, the following table shows how to convert the Level-1 MATLAB S-function `sfundsc2.m` to a Level-2 MATLAB S-function. The example uses the Level-2 MATLAB S-function template `msfuntmp1_basic.m` as a starting point when converting the Level-1 MATLAB S-function. The line numbers in the table corresponds to the lines of code in `sfundsc2.m`.

Line Number	Code in <code>sfundsc2.m</code>	Code in Level-2 MATLAB file (<code>sfundsc2_level2.m</code>)
1	<pre>function [sys,x0,str,ts]= ... sfundsc2(t,x,u,flag)</pre>	<pre>function sfundsc2(block) setup(block);</pre> <p>The syntax for the <code>function</code> line changes to accept one input argument <code>block</code>, which is the Level-2 MATLAB S-Function block's run-time object. The main body of the Level-2 MATLAB S-function contains a single line that calls the local <code>setup</code> function.</p>
13 - 19	<pre>switch flag, case 0, [sys,x0,str,ts] = ... mdlInitializeSizes;</pre>	<pre>function setup(block)</pre> <p>The <code>flag</code> value of zero corresponds to calling the <code>setup</code> method. A Level-2 MATLAB S-function does not use a <code>switch</code> statement to invoke the callback methods. Instead, the local <code>setup</code> function registers callback methods that are directly called during simulation.</p>

Line Number	Code in <code>sfundsc2.m</code>	Code in Level-2 MATLAB file (<code>sfundsc2_level2.m</code>)
24 - 31	<pre> case 2, sys = mdlUpdate(t,x,u); case 3, sys = mdlOutputs(t,x,u); </pre>	<p>The setup function registers two local functions associated with flag values of 2 and 3.</p> <pre> block.RegBlockMethod('Outputs' ,@Output); block.RegBlockMethod('Update' ,@Update); </pre>
53 - 66	<pre> sizes = simsizes; sizes.NumContStates = 0; sizes.NumDiscStates = 1; sizes.NumOutputs = 1; sizes.NumInputs = 1; sizes.DirFeedthrough = 0; sizes.NumSampleTimes = 1; sys = simsizes(sizes); x0 = 0; str = []; ts = [.1 0]; </pre>	<p>The setup function also initializes the attributes of the Level-2 MATLAB S-function:</p> <pre> block.NumInputPorts = 1; block.NumOutputPorts = 1; block.InputPort(1).Dimensions = 1; block.InputPort(1).DirectFeedthrough = false; block.OutputPort(1).Dimensions = 1; block.NumDialogPrms = 0; block.SampleTimes = [0.1 0]; </pre> <p>Because this S-function has discrete states, the setup method registers the <code>PostPropagationSetup</code> callback method to initialize a <code>DWork</code> vector and the <code>InitializeConditions</code> callback method to set the initial state value.</p> <pre> block.RegBlockMethod('PostPropagationSetup',... @DoPostPropSetup); block.RegBlockMethod('InitializeConditions', ... @InitConditions); </pre>

Line Number	Code in <code>sfundsc2.m</code>	Code in Level-2 MATLAB file (<code>sfundsc2_level2.m</code>)
56	<pre>sizes.NumDiscStates = 1;</pre>	<p>The <code>PostPropagationSetup</code> method initializes the <code>DWork</code> vector that stores the single discrete state.</p> <pre>function DoPostPropSetup(block) %% Setup Dwork block.NumDworks = 1; block.Dwork(1).Name = 'x0'; block.Dwork(1).Dimensions = 1; block.Dwork(1).DatatypeID = 0; block.Dwork(1).Complexity = 'Real'; block.Dwork(1).UsedAsDiscState = true;</pre>
64	<pre>x0 = 0;</pre>	<p>The <code>InitializeConditions</code> method initializes the discrete state value.</p> <pre>function InitConditions(block) %% Initialize Dwork block.Dwork(1).Data = 0</pre>
77 - 78	<pre>function sys = ... mdlUpdate(t,x,u) sys = u;</pre>	<p>The <code>Update</code> method calculates the next value of the discrete state.</p> <pre>function Update(block) block.Dwork(1).Data = block.InputPort(1).Data;</pre>
88 - 89	<pre>function sys = ... mdlOutputs(t,x,u) sys = x;</pre>	<p>The <code>Outputs</code> method calculates the S-function's output.</p> <pre>function Output(block) block.OutputPort(1).Data = block.Dwork(1).Data;</pre>

Writing S-Functions in C

- “Introduction” on page 4-2
- “Build S-Functions Automatically” on page 4-5
- “S-Function Builder Dialog Box” on page 4-12
- “Basic C MEX S-Function” on page 4-43
- “Templates for C S-Functions” on page 4-50
- “Integrate C Functions Using Legacy Code Tool” on page 4-55
- “Simulink Engine Interaction with C S-Functions” on page 4-76
- “Write Callback Methods” on page 4-89
- “S-Functions in Normal Mode Referenced Models” on page 4-90
- “Debug C MEX S-Functions” on page 4-92
- “Convert Level-1 C MEX S-Functions” on page 4-100

Introduction

In this section...

“About Writing C S-Functions” on page 4-2

“Creating C MEX S-Functions” on page 4-3

About Writing C S-Functions

A C MEX S-function must provide information about the function to the Simulink engine during the simulation. As the simulation proceeds, the engine, the ODE solver, and the C MEX S-function interact to perform specific tasks. These tasks include defining initial conditions and block characteristics, and computing derivatives, discrete states, and outputs.

As with MATLAB S-functions, the Simulink engine interacts with a C MEX S-function by invoking callback methods that the S-function implements. Each method performs a predefined task, such as computing block outputs, required to simulate the block whose functionality the S-function defines. However, the S-function is free to perform the task in each method according to the functionality the S-function implements. For example, the `mdlOutputs` method must compute the block outputs at the current simulation time. However, the S-function can calculate these outputs in any way that is appropriate for the function. This callback-based API allows you to create S-functions, and hence custom blocks, of any desired functionality.

The set of callback methods that C MEX S-functions can implement is larger than that available for MATLAB S-functions. C MEX S-functions are required to implement only a small subset of the callback methods in the S-function API. If your block does not implement a particular feature, such as matrix signals, you are free to omit the callback methods needed to implement a feature. This allows you to create simple blocks very quickly.

The general format of a C MEX S-function is shown below:

```
#define S_FUNCTION_NAME your_sfunction_name_here
#define S_FUNCTION_LEVEL 2
#include "simstruc.h"
```

```
static void mdlInitializeSizes(SimStruct *S)
{
}

<additional S-function routines/code>

static void mdlTerminate(SimStruct *S)
{
}
#ifdef MATLAB_MEX_FILE    /* Is this file being compiled as a
                           MEX-file? */
#include "simulink.c"      /* MEX-file interface mechanism */
#else
#include "cg_sfun.h"      /* Code generation registration
                           function */
#endif
```

`mdlInitializeSizes` is the first routine the Simulink engine calls when interacting with the S-function. The engine subsequently invokes other S-function methods (all starting with `mdl`). At the end of a simulation, the engine calls `mdlTerminate`.

Creating C MEX S-Functions

You can create C MEX S-functions using any of the following approaches:

- **Handwritten S-function** — You can write a C MEX S-function from scratch. (“Basic C MEX S-Function” on page 4-43 provides a step-by-step example.) See “Templates for C S-Functions” on page 4-50 for a complete skeleton implementation of a C MEX S-function that you can use as a starting point for creating your own S-functions.
- **S-Function Builder** — This block builds a C MEX S-function from specifications and code fragments that you supply using a graphical user interface. This eliminates the need for you to write S-functions from scratch. See “Build S-Functions Automatically” on page 4-5 for more information about the S-Function Builder.
- **Legacy Code Tool** — This utility builds a C MEX S-function from existing C code and specifications that you supply using MATLAB code. See

“Integrate C Functions Using Legacy Code Tool” on page 4-55 for more information about integrating legacy C code into Simulink models.

Each of these approaches involves a tradeoff between the ease of writing an S-function and the features supported by the S-function. Although handwritten S-functions support the widest range of features, they can be difficult to write. The S-Function Builder block simplifies the task of writing C MEX S-functions but supports fewer features. The Legacy Code Tool provides the easiest approach to creating C MEX S-functions from existing C code but supports the fewest features. See “Available S-Function Implementations” on page 2-2 for more information on the features and limitations of each of these approaches to writing a C MEX S-function.

If you have Simulink Coder, in addition to the previous three approaches, the Simulink Coder product provides a method for generating a C MEX S-function from a graphical subsystem. If you are new to writing C MEX S-functions, you can build portions of your application in a Simulink subsystem and use the S-function target to convert it to an S-function. The generated files provides insight on how particular blocks can be implemented within an S-function. For details and limitations on using the S-function target, see “Generated S-Function Block”.

Build S-Functions Automatically

In this section...

“About Building S-Functions Automatically” on page 4-5

“Deploying the Generated S-Function” on page 4-10

“How the S-Function Builder Builds an S-Function” on page 4-11

About Building S-Functions Automatically

The S-Function Builder is a Simulink block that builds an S-function from specifications and C code that you supply. The S-Function Builder also serves as a wrapper for the generated S-function in models that use the S-function. This section explains how to use the S-Function Builder to build simple C MEX S-functions.

Note For examples of using the S-Function Builder to build S-functions, see the C file S-functions subsystem of the S-function examples provided with the Simulink product. To display the examples, enter `sfundemos` at the MATLAB command line (see “S-Function Examples” on page 1-27 for more information).

To build an S-function with the S-Function Builder:

- 1 Set the MATLAB current folder to the folder in which you want to create the S-function.

Note This folder must be on the MATLAB path.

- 2 If you wish to connect a bus signal to the Input or Output port of the S-Function Builder, you must first create a bus object. You perform this task interactively using the Simulink Bus Editor. (For more information, see “Manage Bus Objects with the Bus Editor”. Alternatively, you can use `Simulink.Bus` as follows.
 - a In the MATLAB Command Window, enter:

```
a = Simulink.Bus
```

As a result, the `HeaderFile` for the bus defaults to the empty string:

```
a =
```

```
Simulink.Bus  
  Description: ''  
  HeaderFile: ''  
  Elements: [0x1 double]
```

- b** If you wish to specify the header file for the bus, then at the MATLAB command line:

```
a.Headerfile = 'Busdef.h'
```

If you do not specify a header file, Simulink automatically generates `Sfunctionname_bus.h`

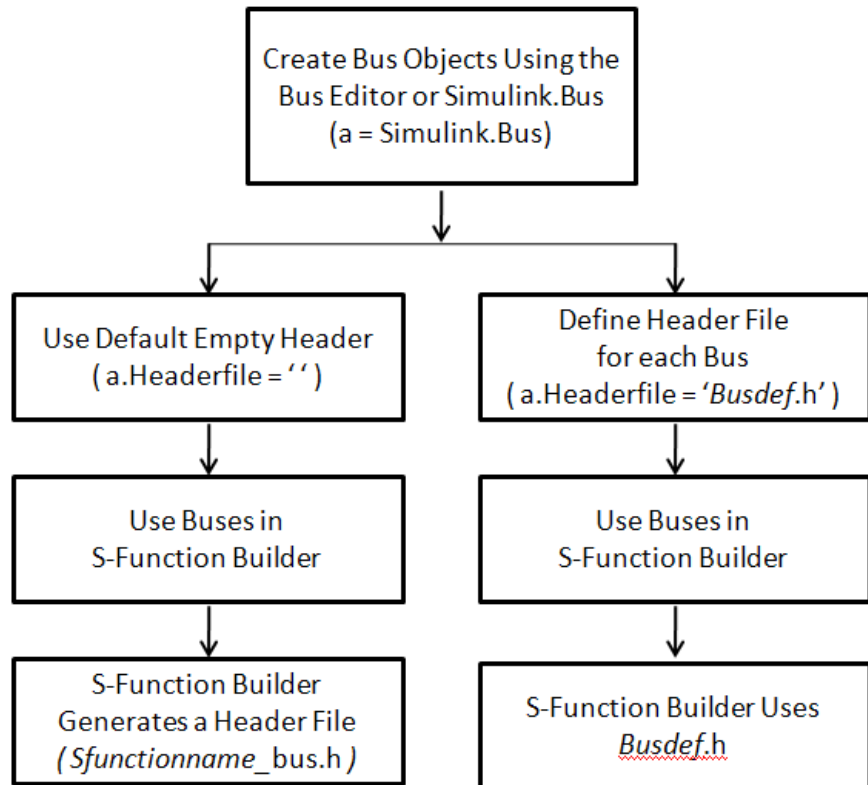

For a demonstration on how to use the S-Function Builder with a bus, see the **S-Function Builder with buses** example by entering the following command at the MATLAB command line:

```
open_system([matlabroot, '/toolbox/simulink/simdemos/simfeatures/...  
sfbuilder_bususage']);
```

- 3** Create a new Simulink model.
- 4** Copy an instance of the S-Function Builder block from the User-Defined Functions library in the Library Browser into the new model.

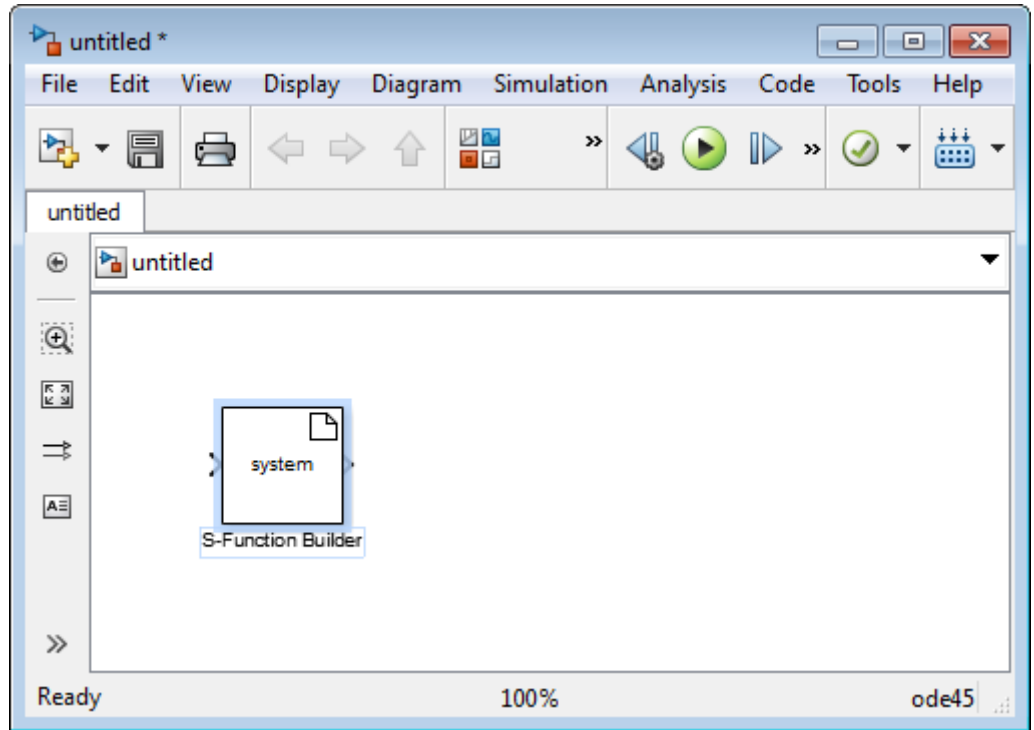

- 5 Double-click the block to open the S-Function Builder dialog box (see “S-Function Builder Dialog Box” on page 4-12).

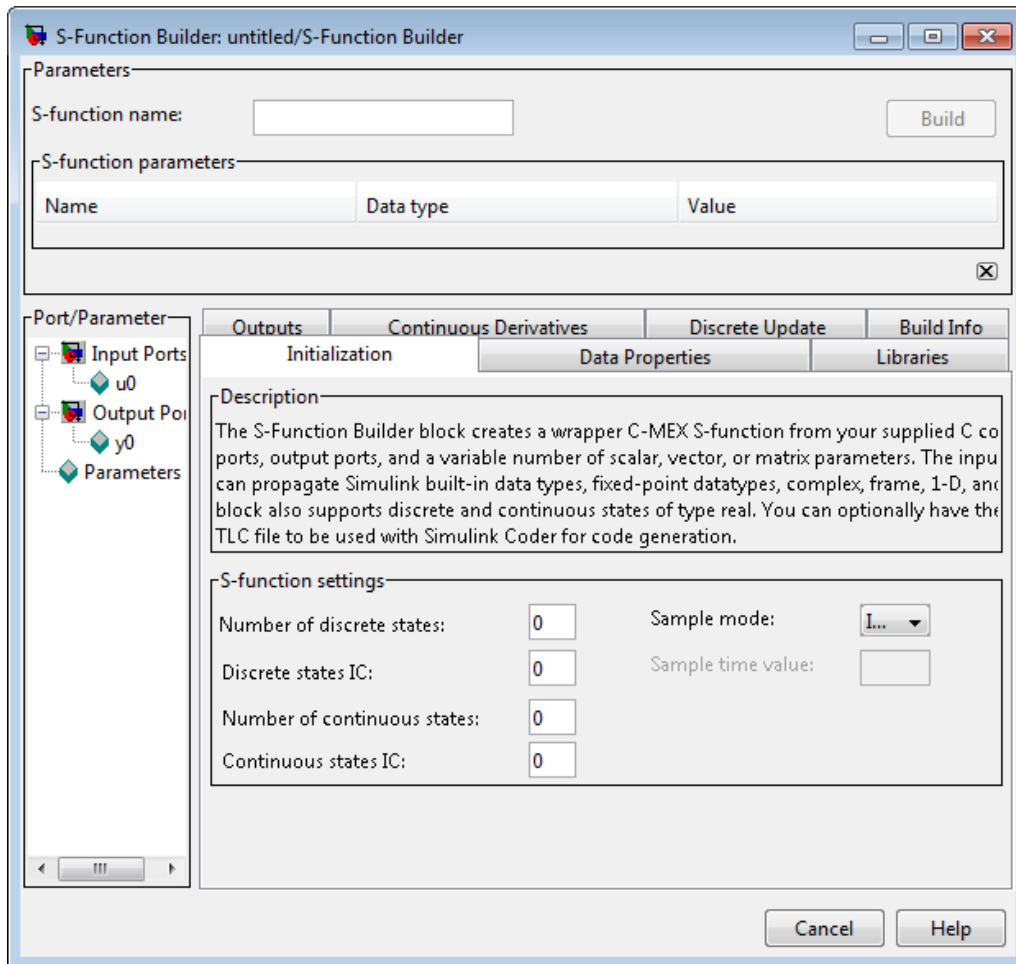

- 6** Use the specification and code entry panes on the S-Function Builder dialog box to enter information and custom source code required to tailor the generated S-function to your application (see “S-Function Builder Dialog Box” on page 4-12).
- 7** If you have not already done so, configure the `mex` command to work on your system.

To configure the `mex` command, type `mex -setup` at the MATLAB command prompt.

- 8 Click **Build** on the S-Function Builder to start the build process.

The S-Function Builder builds a MEX file that implements the specified S-function and saves the file in the current folder (see “How the S-Function Builder Builds an S-Function” on page 4-11).

- 9 Save the model containing the S-Function Builder block.

Deploying the Generated S-Function

To use the generated S-function in another model, first check to ensure that the folder containing the generated S-function is on the MATLAB path. Then copy the S-Function Builder block from the model used to create the S-function into the target model and set its parameters, if necessary, to the values required by the target model.

Alternatively, you can deploy the generated S-function without using the S-Function Builder block or exposing the underlying C source file. To do this:

- 1 Open the Simulink model that will include the S-function.
- 2 Copy an S-Function block from the User-Defined Functions library in the Library Browser into the model.
- 3 Double-click on the S-Function block.
- 4 In the Block Parameters dialog box that opens, enter the name of the executable file generated by the S-Function Builder into the **S-function name** edit field.
- 5 Enter any parameters needed by the S-function into the **S-function parameters** edit field. Enter the parameters in the order they appear in the S-Function Builder dialog box.
- 6 Click **OK** on the S-Function Block Parameters dialog box.

You can use the generated executable file, for example, the `.mexw32` file, in any S-Function block in any model as long as the executable file is on the MATLAB path.

How the S-Function Builder Builds an S-Function

The S-Function Builder builds an S-function as follows. First, it generates the following source files in the current folder:

- `sfun.c`

where `sfun` is the name of the S-function that you specify in the **S-function name** field of the S-Function Builder dialog box. This file contains the C source code representation of the standard portions of the generated S-function.

- `sfun_wrapper.c`

This file contains the custom code that you entered in the S-Function Builder dialog box.

- `sfun.tlc`

This file permits the generated S-function to run in Simulink Rapid Accelerator mode and allows for inlining the S-function during code generation. In addition, this file generates code for the S-function in Accelerator mode, thus allowing the model to run faster.

- `sfun_bus.h`

If you specify any `Input port` or `Output port` as a bus in the Data Properties pane of the S-Function Builder dialog box, but do not specify a header file, then the S-Function Builder automatically generates this header file.

After generating the S-function source code, the S-Function Builder uses the `mex` command to build the MEX file representation of the S-function from the generated source code and any external custom source code and libraries that you specified.

S-Function Builder Dialog Box

In this section...
“About S-Function Builder” on page 4-12
“Parameters/S-Function Name Pane” on page 4-14
“Port/Parameter Pane” on page 4-15
“Initialization Pane” on page 4-16
“Data Properties Pane” on page 4-18
“Input Ports Pane” on page 4-19
“Output Ports Pane” on page 4-20
“Parameters Pane” on page 4-22
“Data Type Attributes Pane” on page 4-23
“Libraries Pane” on page 4-24
“Outputs Pane” on page 4-26
“Continuous Derivatives Pane” on page 4-30
“Discrete Update Pane” on page 4-32
“Build Info Pane” on page 4-34
“Example: Modeling a Two-Input/Two-Output System” on page 4-37

About S-Function Builder

The S-Function Builder dialog box enables you to specify the attributes of an S-function to be built by an S-Function Builder block. To display the dialog box, double-click the S-Function Builder block icon or select the block and then select **Open Block** from the **Edit** menu on the model editor or the block’s context menu. The dialog box appears.

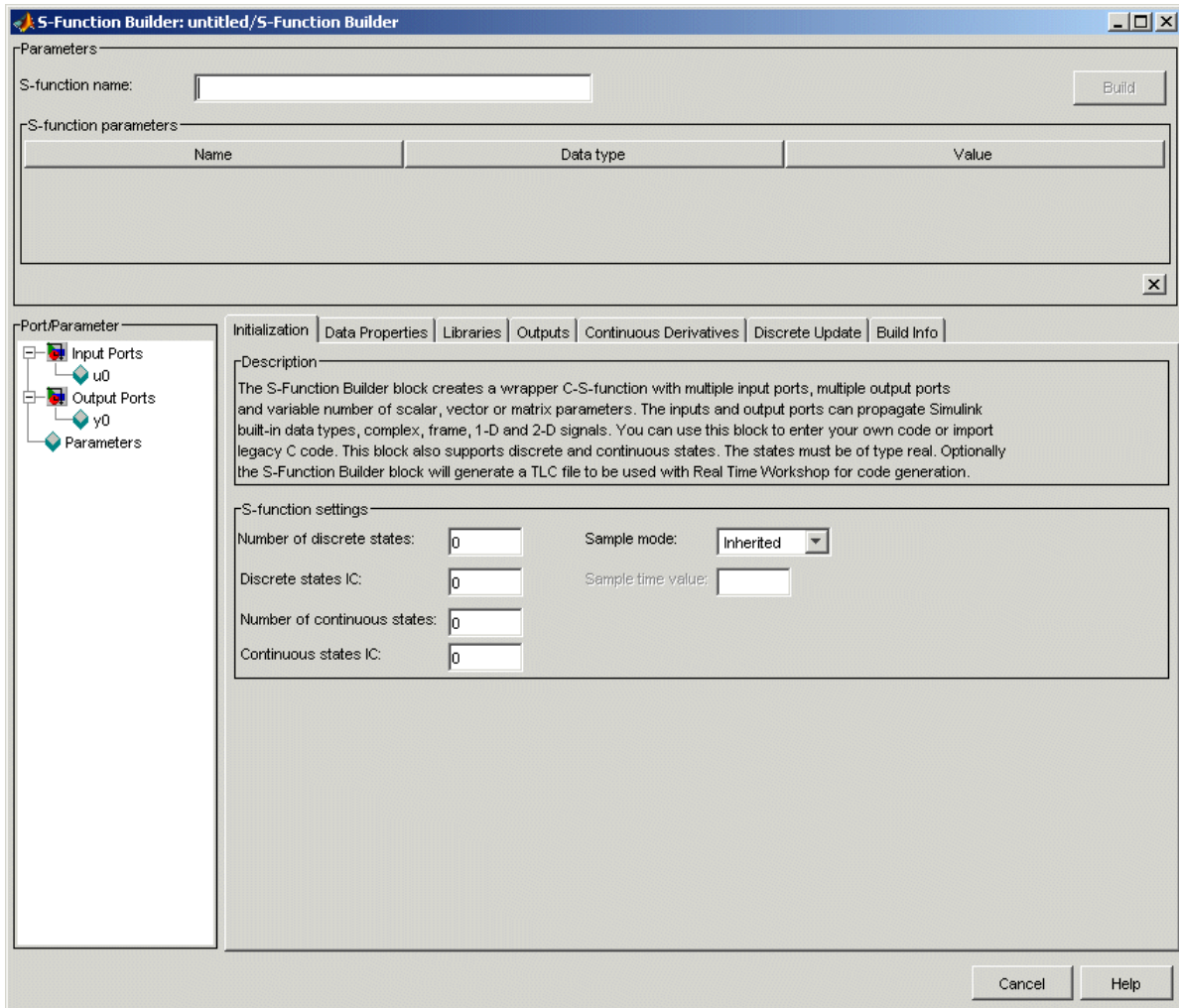

The dialog box contains controls that let you enter information needed for the S-Function Builder block to build an S-function to your specifications. The controls are grouped into panes. See the following sections for information on the panes and the controls that they contain.

Note The following sections use the term *target S-function* to refer to the S-function specified by the S-Function Builder dialog box.

See “Example: Modeling a Two-Input/Two-Output System” on page 4-37 for an example showing how to use the S-Function Builder to model a two-input/two-output discrete state-space system.

Parameters/S-Function Name Pane

This pane displays the target S-function name and parameters.

The screenshot shows a dialog box titled "Parameters". At the top, there is a label "S-function name:" followed by a text input field and a "Build" button. Below this is a section titled "S-function parameters" containing a table with three columns: "Name", "Data type", and "Value".

Name	Data type	Value
a	double	1
b	double	1

The pane contains the following controls.

S-function name

Specifies the name of the target S-function.

S-function parameters

This table displays the parameters of the target S-function. Each row of the table corresponds to a parameter, and each column displays a property of the parameter as follows:

- **Name** — Name of the parameter. Define and modify this property from the “Parameters Pane” on page 4-22.
- **Data type** — Lists the data type of the parameter. Define and modify this property from the “Parameters Pane” on page 4-22.

- **Value** — Specifies the value of the parameter. Enter a valid MATLAB expression in this field.

Build/Save

Use this button to generate the C source code and executable MEX file from the information you entered in the S-Function Builder. If the button is labeled **Build**, the S-Function Builder generates the source code and executable MEX file. If the button is labeled **Save**, it generates only the C source code. Use the **Save code only** check box on the **Build Info** pane to toggle the functionality of this button.

Hide/Show S-function editing tabs

Use the small button at the bottom-right of the **Parameters/S-Function Name** pane, to collapse and expand the bottom portion of the S-Function Builder dialog box.

Port/Parameter Pane

This pane displays the ports and parameters that the dialog box specifies for the target S-function.

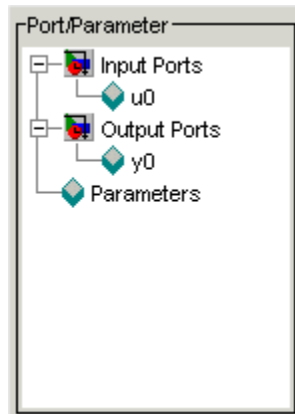

The pane contains a tree control whose top nodes correspond to the target S-function input ports, output ports, and parameters, respectively. Expanding the Input Ports, Output Ports, or Parameter node displays the input ports,

output ports, or parameters, respectively, specified for the target S-function. Selecting any of the port or parameter nodes selects the corresponding entry on the corresponding port or parameter specification pane.

Initialization Pane

The **Initialization** pane allows you to specify basic features of the S-function, such as the width of its input and output ports and its sample time.

The screenshot shows the 'Initialization' pane of the S-Function Builder. The pane has several tabs: 'Initialization', 'Data Properties', 'Libraries', 'Outputs', 'Continuous Derivatives', 'Discrete Update', and 'Build Info'. The 'Initialization' tab is selected. Below the tabs, there is a 'Description' section with the following text: 'The S-Function Builder block creates a wrapper C-S-function with multiple input ports, multiple output ports and variable number of scalar, vector or matrix parameters. The inputs and output ports can propagate Simulink built-in data types, complex, frame, 1-D and 2-D signals. You can use this block to enter your own code or import legacy C code. This block also supports discrete and continuous states. The states must be of type real. Optionally the S-Function Builder block will generate a TLC file to be used with Real Time Workshop for code generation.' Below the description is the 'S-function settings' section, which contains the following fields: 'Number of discrete states:' with a text box containing '0'; 'Discrete states IC:' with a text box containing '0'; 'Number of continuous states:' with a text box containing '0'; 'Continuous states IC:' with a text box containing '0'; 'Sample mode:' with a dropdown menu showing 'Inherited'; and 'Sample time value:' with an empty text box.

The S-Function Builder uses the information that you enter on this pane to generate the `mdlInitializeSizes` callback method. The Simulink engine invokes this method during the model initialization phase of the simulation to obtain basic information about the S-function. (See “Simulink Engine Interaction with C S-Functions” on page 4-76 for more information on the model initialization phase.)

The **Initialization** pane contains the following fields.

Number of discrete states

Number of discrete states in the S-function.

Discrete states IC

Initial conditions of the discrete states in the S-function. You can enter the values as a comma-separated list or as a vector (e.g., [0 1 2]). The number of initial conditions must equal the number of discrete states.

Number of continuous states

Number of continuous states in the S-function.

Continuous states IC

Initial conditions of the continuous states in the S-function. You can enter the values as a comma-separated list or as a vector (e.g., [0 1 2]). The number of initial conditions must equal the number of continuous states.

Sample mode

Sample mode of the S-function. The sample mode determines the length of the interval between the times when the S-function updates its output. You can select one of the following options:

- **Inherited**

The S-function inherits its sample time from the block connected to its input port.

- **Continuous**

The block updates its outputs at each simulation step.

- **Discrete**

The S-function updates its outputs at the rate specified in the **Sample time value** field of the S-Function Builder dialog box.

Sample time value

Scalar value indicating the interval between updates of the S-function outputs. This field is enabled only if you select **Discrete** as the **Sample mode**.

Note The S-Function Builder does not currently support multiple-block sample times or a nonzero offset time.

Data Properties Pane

The **Data Properties** pane allows you to add ports and parameters to your S-function.

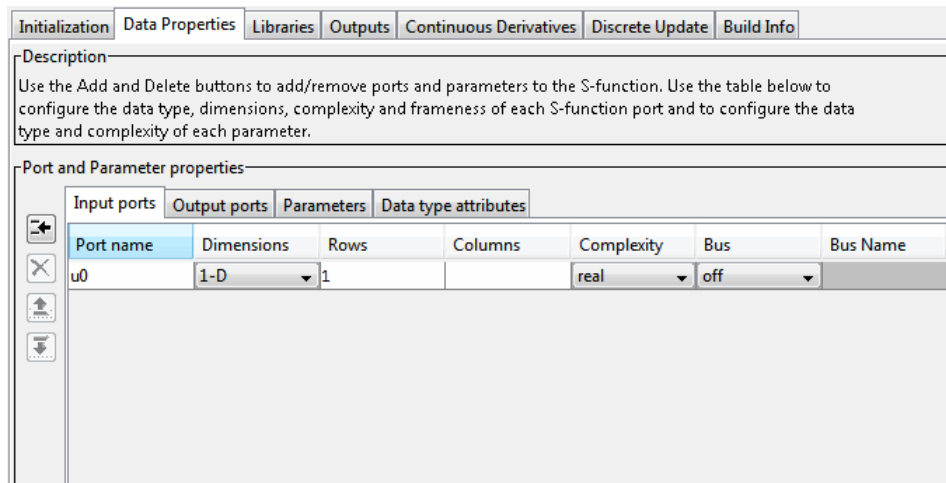

The column of buttons to the left of the panes allows you to add, delete, or reorder ports or parameters, depending on the currently selected pane.

- To add a port or a parameter, click the **Add** button (the top button in the column of buttons).
- To delete the currently selected port or parameter, click the **Delete** button (located beneath the **Add** button).
- To move the currently selected port or parameter up one position in the corresponding S-Function port or parameter list, click the **Up** button (beneath the **Delete** button).
- To move the currently selected port or parameter down one position in the corresponding S-function port or parameter list, click the **Down** button (beneath the **Up** button).

This pane also contains tabbed panes that enable you to specify the attributes of the ports and parameters that you create. See the following topics for more information.

- “Input Ports Pane” on page 4-19
- “Output Ports Pane” on page 4-20
- “Parameters Pane” on page 4-22
- “Data Type Attributes Pane” on page 4-23

Input Ports Pane

The **Input Ports** pane allows you to inspect and modify the properties of the S-function input ports.

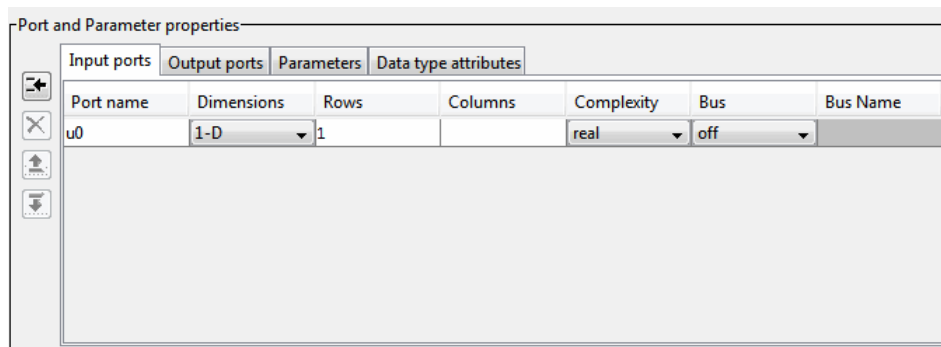

The pane comprises an editable table that lists the properties of the input ports in the order in which the ports appear on the S-Function Builder block. Each row of the table corresponds to a port. Each entry in the row displays a property of the port as follows.

Port name

Name of the port. Edit this field to change the port name.

Dimensions

Lists the number of dimensions of the input signal accepted by the port. To display a list of supported dimensions, click the adjacent button. To change

the port dimensionality, select a new value from the list. Specify 1-D to size the signal dynamically, regardless of the actual dimensionality of the signal.

Rows

Specifies the size of the first (or only) dimension of the input signal. Specify -1 to size the signal dynamically.

Columns

Specifies the size of the second dimension of the input signal (only if the input port accepts 2-D signals).

Note For input signals with two dimensions, if the rows dimension is dynamically sized, the columns dimension must also be dynamically sized or set to 1. If the columns dimension is set to some other value, the S-function will compile, but any simulation containing this S-function will not run due to an invalid dimension specification.

Complexity

Specifies whether the input port accepts real or complex-valued signals.

Bus

If the input signal to the S-Function Builder block is a bus, then use the drop-down menu in the **Bus** column to select 'on'.

Bus Name

Step 2 of the “Build S-Functions Automatically” on page 4-5 instructs you to create a bus object, if your input signal is a bus. In the field provided in the **Bus Name** column, enter the bus name that you defined while creating the inport bus object.

Output Ports Pane

The **Output Ports** pane allows you to inspect and modify the properties of the S-function output ports.

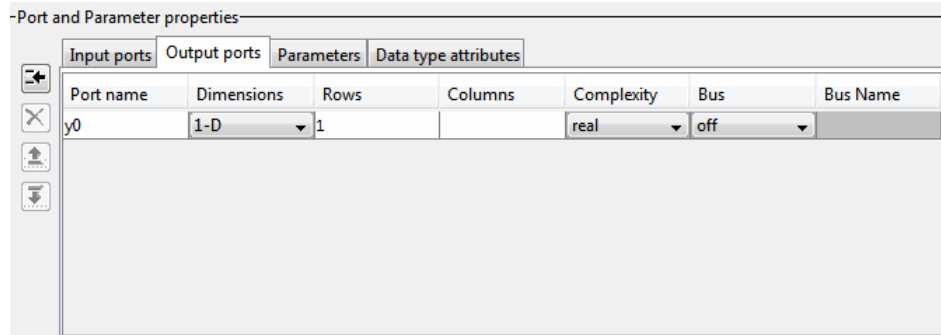

The pane consists of a table that lists the properties of the output ports in the order in which the ports appear on the S-Function block. Each row of the table corresponds to a port. Each entry in the row displays a property of the port as follows.

Port name

Name of the port. Edit this field to change the port name.

Dimensions

Lists the number of dimensions of signals output by the port. To display a list of supported dimensions, click the adjacent button. To change the port dimensionality, select a new value from the list. Specify 1-D to size the signal dynamically, regardless of the actual dimensionality of the signal.

Rows

Specifies the size of the first (or only) dimension of the output signal. Specify -1 to size the signal dynamically.

Columns

Specifies the size of the second dimension of the output signal (only if the port outputs 2-D signals).

Note For output signals with two dimensions, if one of the dimensions is dynamically sized the other dimension must also be dynamically sized or set to 1. If the second dimension is set to some other value, the S-function will compile, but any simulation containing this S-function will not run due to an invalid dimension specification. In some cases, the calculations that determine the dimensions of dynamically sized output ports may be insufficient and both dimensions of the 2-D output signal may need to be hard coded.

Complexity

Specifies whether the port outputs real or complex-valued signals.

Bus

If the output signal to the S-Function Builder block is a bus, then use the drop-down menu in the **Bus** column to select 'on'.

Bus Name

Step 2 of the “Build S-Functions Automatically” on page 4-5 instructs you to create a bus object. In the field provided in the **Bus Name** column, enter the name that you defined while creating the output bus object.

Parameters Pane

The **Parameters** pane allows you to inspect and modify the properties of the S-function parameters.

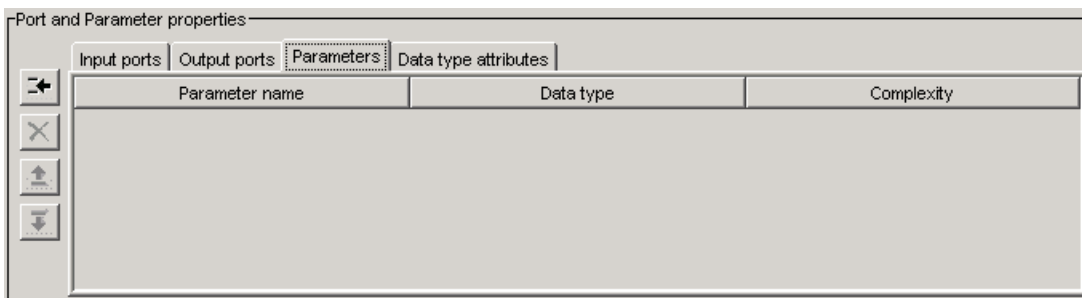

The pane consists of a table that lists the properties of the S-function parameters. Each row of the table corresponds to a parameter. The order in which the parameters appear corresponds to the order in which the user must specify them in the **S-function parameters** field. Each entry in the row displays a property of the parameter as follows.

Parameter name

Name of the parameter. Edit this field to change the name.

Data type

Lists the data type of the parameter. Click the adjacent button to display a list of supported data types. To change the parameter data type, select a new type from the list.

Complexity

Specifies whether the parameter has real or complex values.

Data Type Attributes Pane

This pane allows you to specify the data type attributes of the input and output ports of the target S-function.

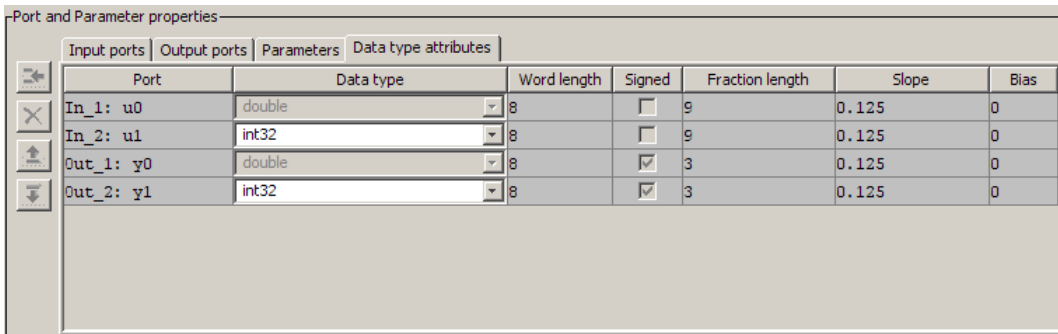

Port	Data type	Word length	Signed	Fraction length	Slope	Bias
In_1: u0	double	8	<input type="checkbox"/>	9	0.125	0
In_2: u1	int32	8	<input type="checkbox"/>	9	0.125	0
Out_1: y0	double	8	<input checked="" type="checkbox"/>	3	0.125	0
Out_2: y1	int32	8	<input checked="" type="checkbox"/>	3	0.125	0

The pane contains a table listing the data type attributes of each of the S-functions ports. You can edit only some of the fields in the table. The other fields are grayed out. Each row corresponds to a port of the target S-function. Each column specifies an attribute of the corresponding port.

Port

Name of the port. This field displays the name entered in the **Input ports** and **Output ports** panes. You cannot edit this field.

Data Type

Data type of the port. Click the adjacent button to display a list of supported data types. To change the data type, select a different data type from the list.

The remaining fields on this pane are enabled only if the **Data Type** field specifies a fixed-point data type. See “Fixed-Point Data” for more information.

Libraries Pane

The **Libraries** pane allows you to specify the location of external code files referenced by custom code that you enter in other panes of the S-Function Builder dialog box.

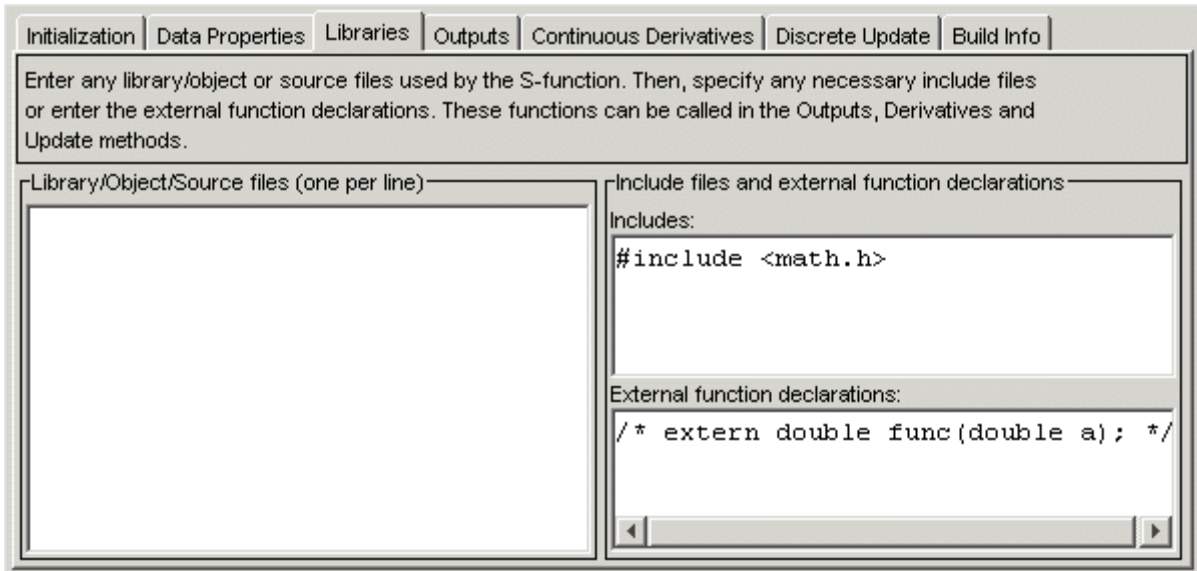

The **Libraries** pane includes the following fields.

Library/Object/Source files

External library, object code, and source files referenced by custom code that you enter elsewhere on the S-Function Builder dialog box. List each file on a separate line. If the file resides in the current folder, you need specify only the file name. If the file resides in another folder, you must specify the full path of the file.

Alternatively, you can also use this field to specify search paths for libraries, object files, header files, and source files. To do this, enter the tag `LIB_PATH`, `INC_PATH`, or `SRC_PATH`, respectively, followed by the path name. You can make as many entries of this kind as you need but each must reside on a separate line.

For example, consider an S-Function Builder project that resides at `d:\matlab6p5\work` and needs to link against the following files:

- `c:\customfolder\customfunctions.lib`
- `d:\matlab7\customobjs\userfunctions.obj`
- `d:\externalsource\freesource.c`

The following entries enable the S-Function Builder to find these files:

```
SRC_PATH d:\externalsource
LIB_PATH $MATLABROOT\customobjs
LIB_PATH c:\customfolder
customfunctions.lib
userfunctions.obj
freesource.c
```

As this example illustrates, you can use `LIB_PATH` to specify both object and library file paths. You can include the library name in the `LIB_PATH` declaration, however you must place the object file name on a separate line. The tag `$MATLABROOT` indicates a path relative to the `MATLAB` installation. You include multiple `LIB_PATH` entries on separate lines. The paths are searched in the order specified.

You can also enter preprocessor (`-D`) directives in this field, for example,

```
-DDEBUG
```

Each directive must reside on a separate line.

Note Do not put quotation marks around the library path, even if the path name has spaces in it. If you add quotation marks, the compiler will not find the library.

Includes

Header files containing declarations of functions, variables, and macros referenced by custom code that you enter elsewhere on the S-Function Builder dialog box. Specify each file on a separate line as `#include` statements. Use brackets to enclose the names of standard C header files (e.g., `#include <math.h>`). Use quotation marks to enclose names of custom header files (e.g., `#include "myutils.h"`). If your S-function uses custom include files that do not reside in the current folder, you must use the `INC_PATH` tag in the **Library/Object/Source files** field to set the include path for the S-Function Builder to the directories containing the include files (see “Library/Object/Source files” on page 4-25).

External function declarations

Declarations of external functions not declared in the header files listed in the **Includes** field. Put each declaration on a separate line. The S-Function Builder includes the specified declarations in the S-function source file that it generates. This allows S-function code that computes the S-function states or outputs to invoke the external functions.

Outputs Pane

Use the **Outputs** pane to enter code that computes the outputs of the S-function at each simulation time step.

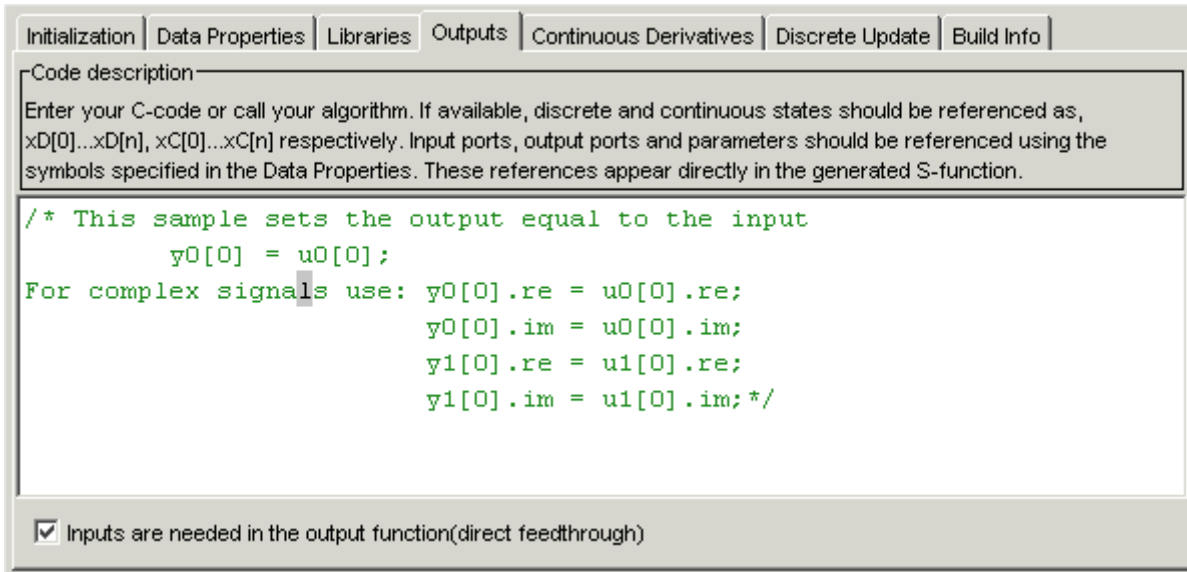

The **Outputs** pane contains the following fields.

Code for the mdlOutputs function

Code that computes the output of the S-function at each simulation time step (or sample time hit, in the case of a discrete S-function). When generating the source code for the S-function, the S-Function Builder inserts the code in this field in a wrapper function of the form

```
void sfun_Outputs_wrapper(const real_T *u,
    real_T *y,
    const real_T *xD, /* optional */
    const real_T *xC, /* optional */
    const real_T *param0, /* optional */
    int_T p_width0 /* optional */
    real_T *param1 /* optional */
    int_t p_width1 /* optional */
    int_T y_width, /* optional */
    int_T u_width) /* optional */
{
```

```
/* Your code inserted here */
}
```

where `sfun` is the name of the S-function. The S-Function Builder inserts a call to this wrapper function in the `mdlOutputs` callback method that it generates for your S-function. The Simulink engine invokes the `mdlOutputs` method at each simulation time step (or sample time step in the case of a discrete S-function) to compute the S-function output. The `mdlOutputs` method in turn invokes the wrapper function containing your output code. Your output code then actually computes and returns the S-function output.

The `mdlOutputs` method passes some or all of the following arguments to the outputs wrapper function.

Argument	Description
<code>u0, u1, ... uN</code>	Pointers to arrays containing the inputs to the S-function, where <code>N</code> is the number of input ports specified on the Input ports pane found on the Data Properties pane. The names of the arguments that appear in the outputs wrapper function are the same as the names found on the Input ports pane. The width of each array is the same as the input width specified for each input on the Input ports pane. If you specified <code>-1</code> as an input width, the width of the array is specified by the wrapper function's <code>u_width</code> argument (see below).
<code>y0, y1, ... yN</code>	Pointer to arrays containing the outputs of the S-function, where <code>N</code> is the number of output ports specified on the Output ports pane found on the Data Properties pane. The names of the arguments that appear in the outputs wrapper function are the same as the names found on the Output ports pane. The width of each array is the same as the output width specified for each output on the Output ports pane. If you specified <code>-1</code> as the output width, the width of the array is specified by the wrapper function's <code>y_width</code> argument (see below). Use this array to pass the outputs that your code computes back to the Simulink engine.

Argument	Description
xD	Pointer to an array containing the discrete states of the S-function. This argument appears only if you specified discrete states on the Initialization pane. At the first simulation time step, the discrete states have the initial values that you specified on the Initialization pane. At subsequent sample-time steps, the states are obtained from the values that the S-function computes at the preceding time step (see “Discrete Update Pane” on page 4-32 for more information).
xC	Pointer to an array containing the continuous states of the S-function. This argument appears only if you specified continuous states on the Initialization pane. At the first simulation time step, the continuous states have the initial values that you specified on the Initialization pane. At subsequent time steps, the states are obtained by numerically integrating the derivatives of the states at the preceding time step (see “Continuous Derivatives Pane” on page 4-30 for more information).
param0, p_width0, param1, p_width1, ... paramN, p_widthN	param0, param1, ...paramN are pointers to arrays containing the S-function parameters, where N is the number of parameters specified on the Parameters pane found on the Data Properties pane. p_width0, p_width1, ...p_widthN are the widths of the parameter arrays. If a parameter is a matrix, the width equals the product of the dimensions of the arrays. For example, the width of a 3-by-2 matrix parameter is 6. These arguments appear only if you specify parameters on the Data Properties pane.

Argument	Description
y_width	Width of the array containing the S-function outputs. This argument appears in the generated code only if you specified -1 as the width of the S-function output. If the output is a matrix, y_width is the product of the dimensions of the matrix.
u_width	Width of the array containing the S-function inputs. This argument appears in the generated code only if you specified -1 as the width of the S-function input. If the input is a matrix, u_width is the product of the dimensions of the matrix.

These arguments permit you to compute the output of the block as a function of its inputs and, optionally, its states and parameters. The code that you enter in this field can invoke external functions declared in the header files or external declarations on the **Libraries** pane. This allows you to use existing code to compute the outputs of the S-function.

Inputs are needed in the output function

Select this check box if the current values of the S-function inputs are used to compute its outputs. The Simulink engine uses this information to detect algebraic loops created by directly or indirectly connecting the S-function output to the S-function input.

Continuous Derivatives Pane

If the S-function has continuous states, use the **Continuous Derivatives** pane to enter code required to compute the state derivatives.

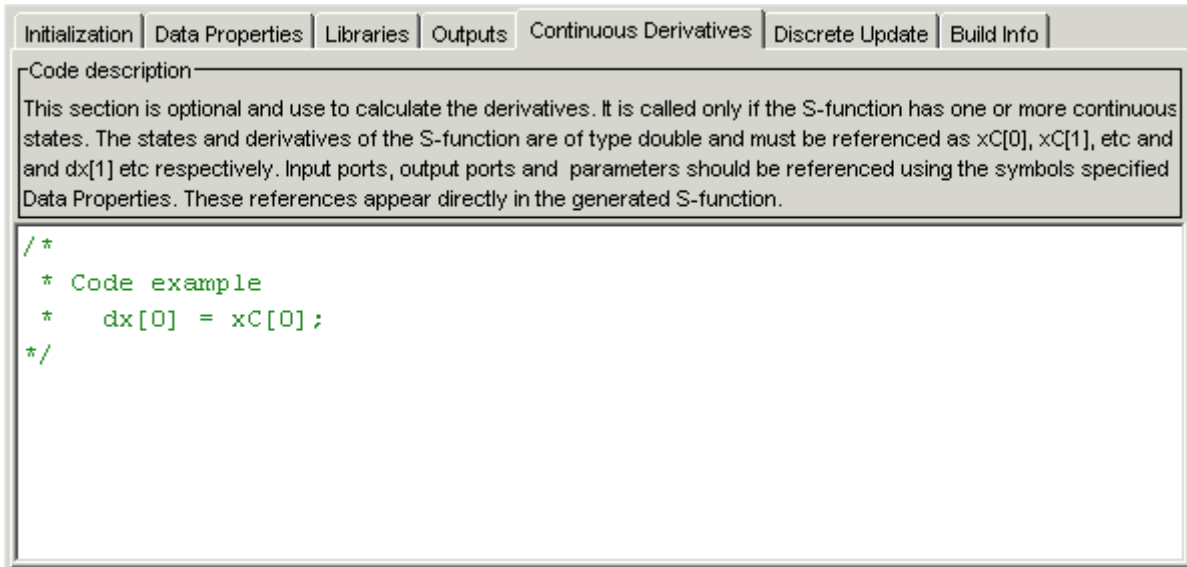

Enter code to compute the derivatives of the continuous states in the **Code for the mdlDerivatives function** field on this pane. When generating code, the S-Function Builder takes the code in this pane and inserts it in a wrapper function of the form

```
void sfun_Derivatives_wrapper(const real_T *u,
    const real_T *y,
    real_T *dx,
    real_T *xC,
    const real_T *param0, /* optional */
    int_T p_width0, /* optional */
    real_T *param1, /* optional */
    int_T p_width1, /* optional */
    int_T y_width, /* optional */
    int_T u_width) /* optional */
{
    /* Your code inserted here. */
}
```

where `sfun` is the name of the S-function. The S-Function Builder inserts a call to this wrapper function in the `mdlDerivatives` callback method that it generates for the S-function. The Simulink engine calls the `mdlDerivatives` method at the end of each time step to obtain the derivatives of the continuous states (see “Simulink Engine Interaction with C S-Functions” on page 4-76). The Simulink solver numerically integrates the derivatives to determine the continuous states at the next time step. At the next time step, the engine passes the updated states back to the `mdlOutputs` method (see “Outputs Pane” on page 4-26).

The `mdlDerivatives` callback method generated for the S-function passes the following arguments to the derivatives wrapper function:

- `u`
- `y`
- `dx`
- `xC`
- `param0, p_width0, param1, p_width1, ... paramN, p_widthN`
- `y_width`
- `u_width`

The `dx` argument is a pointer to an array whose width is the same as the number of continuous derivatives specified on the **Initialization** pane. Your code should use this array to return the values of the derivatives that it computes. See “Outputs Pane” on page 4-26 for the meanings and usage of the other arguments. The arguments allow your code to compute derivatives as a function of the S-function inputs, outputs, and, optionally, parameters. Your code can invoke external functions declared on the **Libraries** pane.

Discrete Update Pane

If the S-function has discrete states, use the **Discrete Update** pane to enter code that computes at the current time step the values of the discrete states at the next time step.

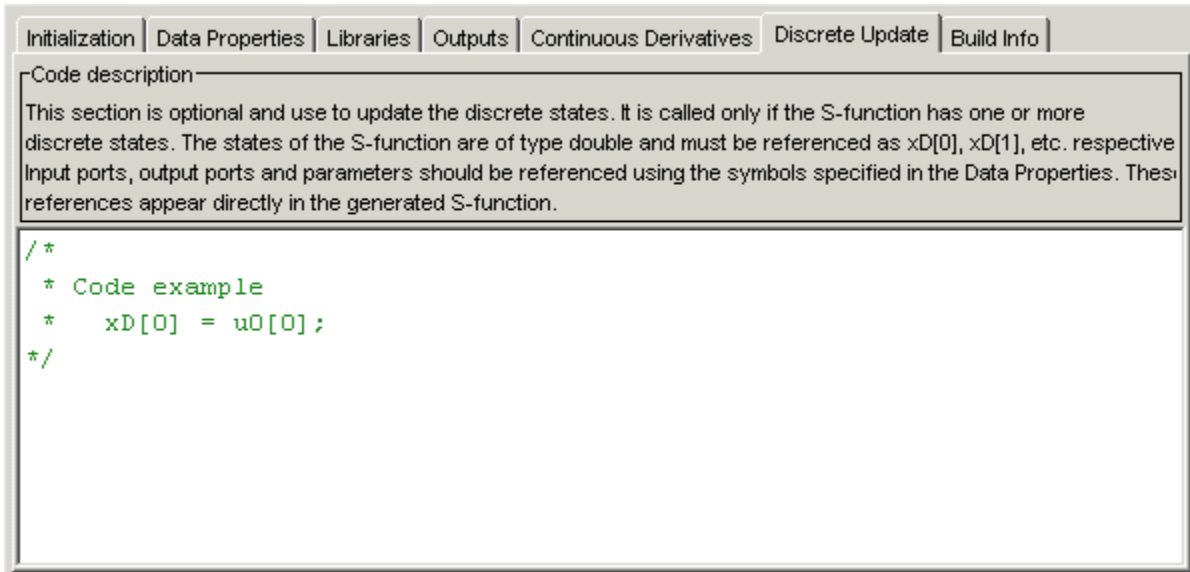

Enter code to compute the values of the discrete states in the **Code for the mdlUpdate function** field on this pane. When generating code, the S-Function Builder takes the code in this pane and inserts it in a wrapper function of the form

```

void sfun_Update_wrapper(const real_T *u,
    const real_T *y,
    real_T *xD,
    const real_T *param0, /* optional */
    int_T p_width0, /* optional */
    real_T *param1, /* optional */
    int_T p_width1, /* optional */
    int_T y_width, /* optional */
    int_T u_width) /* optional */
{
    /* Your code inserted here. */
}

```

where `sfun` is the name of the S-function. The S-Function Builder inserts a call to this wrapper function in the `mdlUpdate` callback method that it generates for the S-function. The Simulink engine calls the `mdlUpdate` method at the end of each time step to obtain the values of the discrete states at the next time step (see “Simulink Engine Interaction with C S-Functions” on page 4-76). At the next time step, the engine passes the updated states back to the `mdlOutputs` method (see “Outputs Pane” on page 4-26).

The `mdlUpdates` callback method generated for the S-function passes the following arguments to the updates wrapper function:

- `u`
- `y`
- `xD`
- `param0, p_width0, param1, p_width1, ... paramN, p_widthN`
- `y_width`
- `u_width`

See “Outputs Pane” on page 4-26 for the meanings and usage of these arguments. Your code should use the `xD` (discrete states) variable to return the values of the discrete states that it computes. The arguments allow your code to compute the discrete states as functions of the S-function inputs, outputs, and, optionally, parameters. Your code can invoke external functions declared on the **Libraries** pane.

Build Info Pane

Use the **Build Info** pane to specify options for building the S-function MEX file.

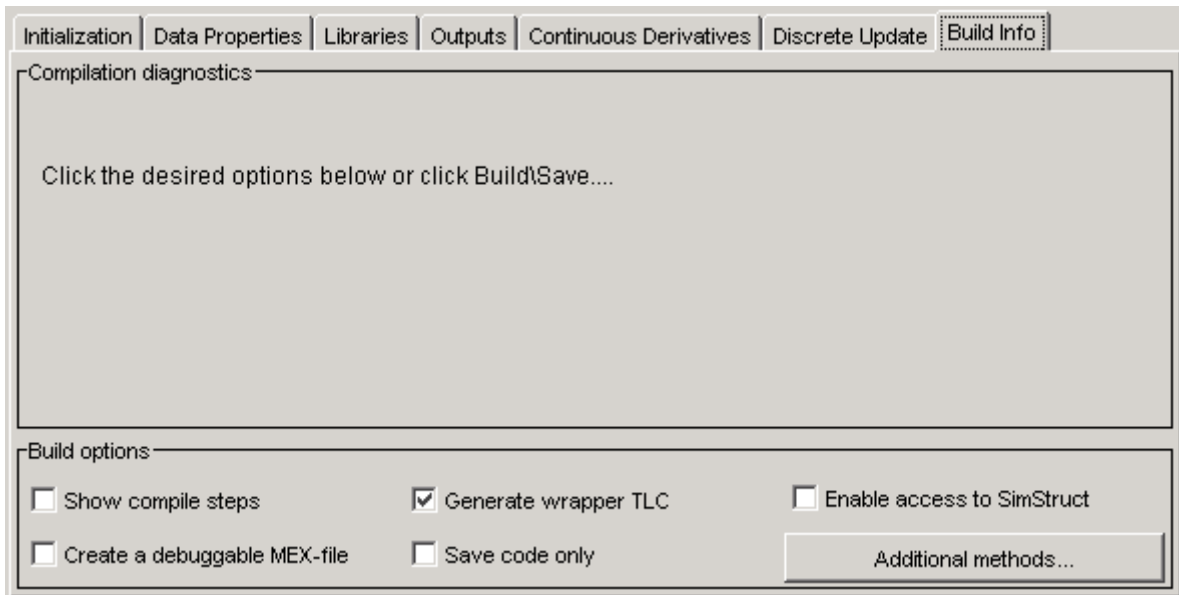

This pane contains the following fields.

Compilation diagnostics

Displays information as the S-Function Builder is generating the C source and executable files.

Show compile steps

Log each build step in the **Compilation diagnostics** field.

Create a debuggable MEX-File

Include debug information in the generated MEX file.

Generate wrapper TLC

Selecting this option allows you to generate a TLC file. You need to generate a TLC file if you are running your model in Rapid Accelerator mode or generating Simulink Coder code from your model. Also, while it is not

necessary for Accelerator mode simulations, the TLC file will generate code for the S-function and thus makes your model run faster in Accelerator mode.

Save code only

Do not build a MEX file from the generated source code.

Enable access to SimStruct

Makes the SimStruct (S) accessible to the wrapper functions that S-Function Builder generates. This enables you to use the SimStruct macros and functions with your code in the **Outputs**, **Continuous Derivatives**, and **Discrete Updates** panes. For example, with this option enabled, you can use macros such as `ssGetT` in code that computes the S-function outputs:

```
double t = ssGetT(S);
    if(t < 2 ) {
        y0[0] = u0[0];
    } else {
        y0[0]= 0.0;
    }
```

Additional methods

Click this button to include additional TLC methods in the TLC file for your S-function. The following dialog box appears.

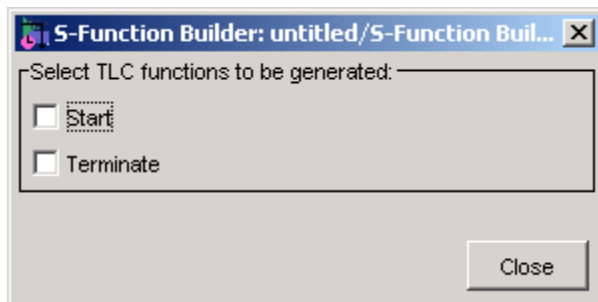

Check the methods you want to add and click the **Close** button to include the methods in your TLC file. For more information, see “Block Target File Methods”.

Example: Modeling a Two-Input/Two-Output System

The example `sfbuilder_example` shows how to use the S-Function Builder to model a two-input/two-output discrete state-space system with two states. In the example, the state-space matrices are parameters to the S-function and the S-function input and output are vectors. You can find a manually written version of the S-function in `dsfunc.c`.

Note You need to build the S-function before running the example model. To build the S-function, double-click on the S-Function Builder block in the model and click **Build** on the S-Function Builder dialog box that opens.

Initializing S-Function Settings

The **Initialization** pane specifies the number of discrete states and their initial conditions, as well as sets the sample time of the S-function. This example contains two discrete states, each initialized to 1, and a discrete sample mode with a sample time of 1.

The screenshot shows the configuration dialog for the S-Function Builder block. It has several tabs: Initialization, Data Properties, Libraries, Outputs, Continuous Derivatives, Discrete Update, and Build Info. The 'Description' tab is active, showing a text box with the following text: "The S-Function Builder block creates a wrapper C-MEX S-function from your supplied C code with multiple input ports, output ports, and a variable number of scalar, vector, or matrix parameters. The input and output ports can propagate Simulink built-in data types, fixed-point datatypes, complex, frame, 1-D, and 2-D signals. This block also supports discrete and continuous states of type real. You can optionally have the block generate a TLC file to be used with Real-Time Workshop for code generation." Below the description is the 'S-function settings' section, which contains several input fields and a dropdown menu: 'Number of discrete states' is set to 2; 'Discrete states IC' is set to 1,1; 'Number of continuous states' is set to 0; 'Continuous states IC' is set to 0; 'Sample mode' is set to Discrete; and 'Sample time value' is set to 1.

Tab	Value
Initialization	
Data Properties	
Libraries	
Outputs	
Continuous Derivatives	
Discrete Update	
Build Info	

Description

The S-Function Builder block creates a wrapper C-MEX S-function from your supplied C code with multiple input ports, output ports, and a variable number of scalar, vector, or matrix parameters. The input and output ports can propagate Simulink built-in data types, fixed-point datatypes, complex, frame, 1-D, and 2-D signals. This block also supports discrete and continuous states of type real. You can optionally have the block generate a TLC file to be used with Real-Time Workshop for code generation.

S-function settings

Number of discrete states:	<input type="text" value="2"/>	Sample mode:	<input type="text" value="Discrete"/>
Discrete states IC:	<input type="text" value="1,1"/>	Sample time value:	<input type="text" value="1"/>
Number of continuous states:	<input type="text" value="0"/>		
Continuous states IC:	<input type="text" value="0"/>		

Initializing Inputs, Outputs, and Parameters

The **Data Properties** pane specifies the dimensions of the S-function input and output, as well as initializes the state-space matrices.

The **Input ports** pane defines the one S-function input port as a 1-D vector with two rows.

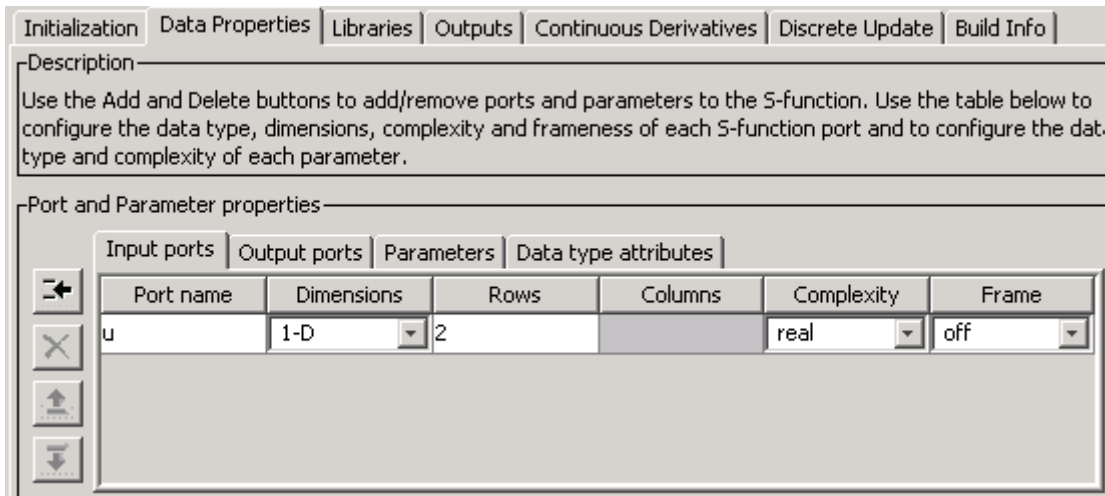

The **Output ports** pane similarly defines the one S-function output port as a 1-D vector with two rows.

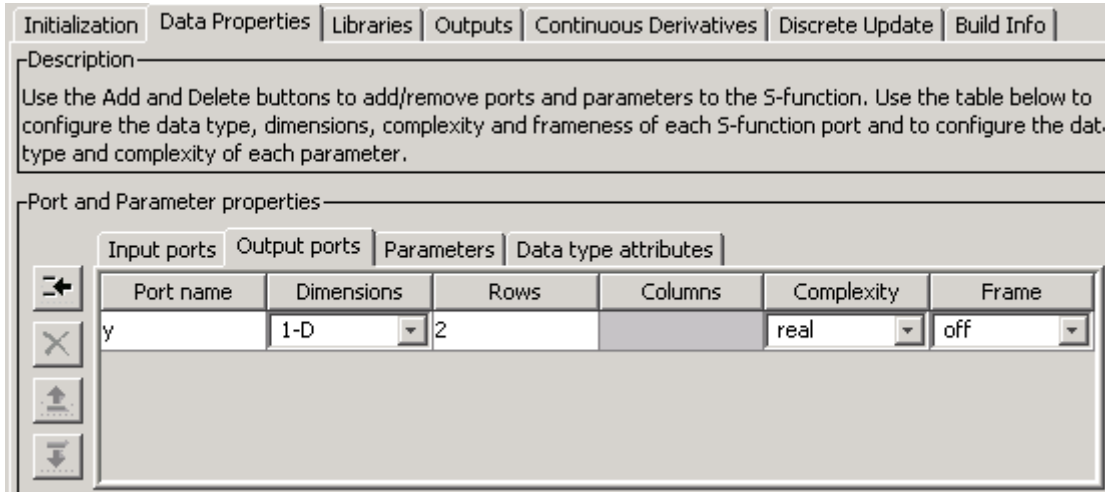

The **Parameters** pane defines four parameters, one for each of the four state-space matrices.

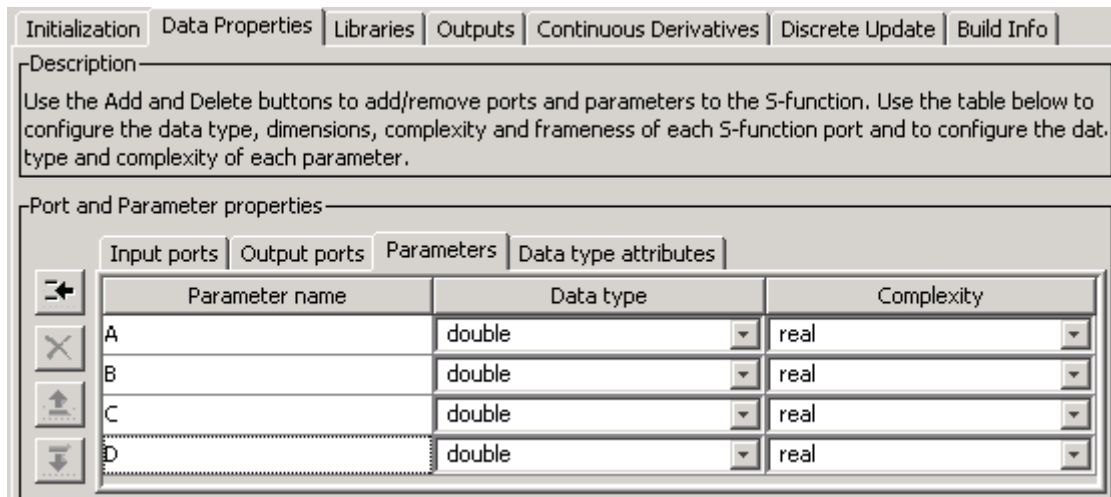

The **S-function parameters** pane at the top of the S-Function Builder contains the actual values for the state-space matrices, entered as MATLAB expressions. In this example, each state-space parameter is a two-by-two matrix. Alternatively, you can store the state-space matrices in variables in the MATLAB workspace and enter the variable names into the **Value** field for each parameter.

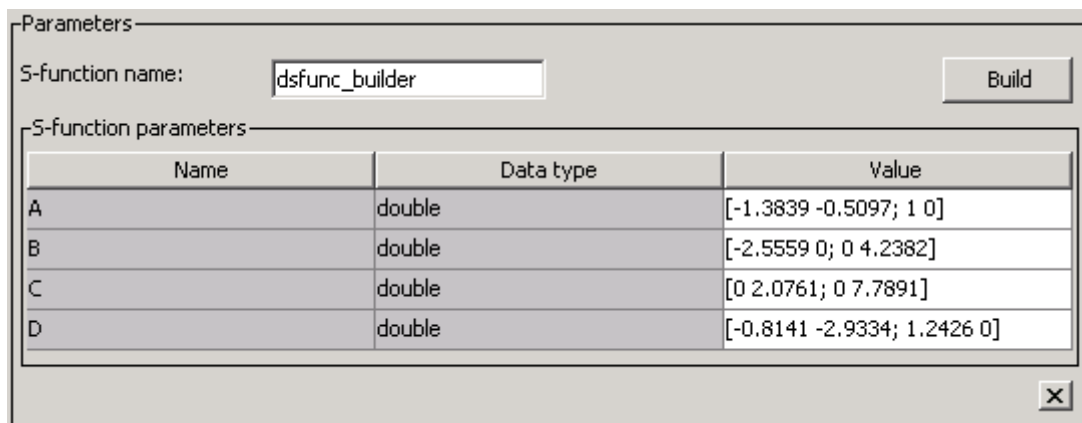

Defining the Output Method

The **Outputs** pane calculates the S-function output as a function of the input and state vectors and the state-space matrices. In the outputs code, reference S-function parameters using the parameter names defined on the **Data Properties — Parameters** pane. Index into 2-D matrices using a scalar index, keeping in mind that S-functions use zero-based indexing. For example, to access the element $C(2, 1)$ in the S-function parameter C , use $C[1]$ in the S-function code.

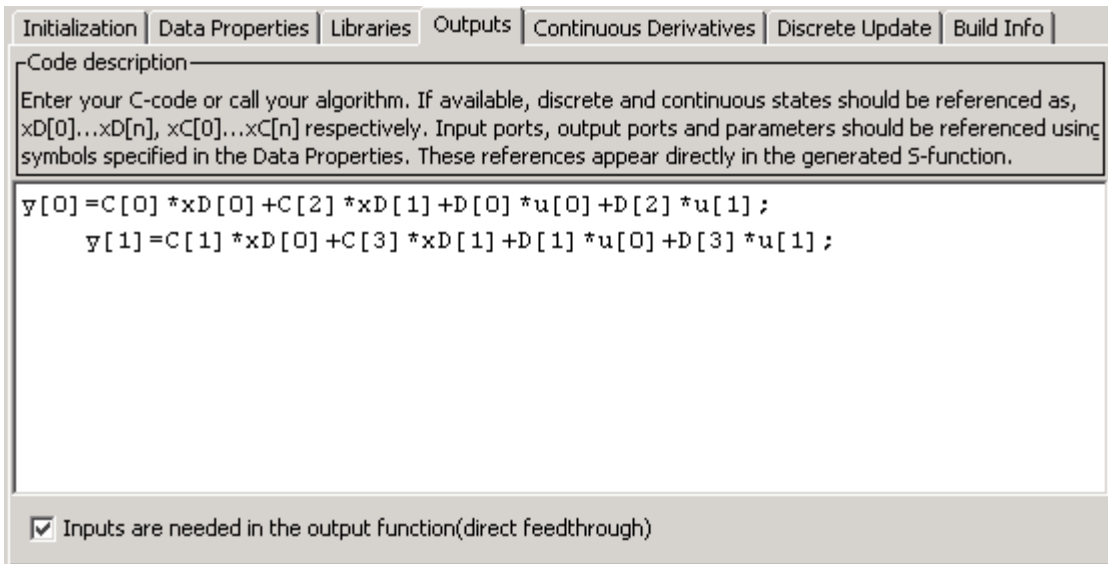

The **Outputs** pane also selects the **Inputs are needed in the output function (direct feedthrough)** option since this state-space model has a nonzero D matrix.

Defining the Discrete Update Method

The **Discrete Update** pane updates the discrete states. As with the outputs code, use the S-function parameter names and index into 2-D matrices using a scalar index, keeping in mind that S-functions use zero-based indexing. For example, to access the element $A(2, 1)$ in the S-function parameter A , use $A[1]$ in the S-function code. The variable xD stores the final values of the discrete states.

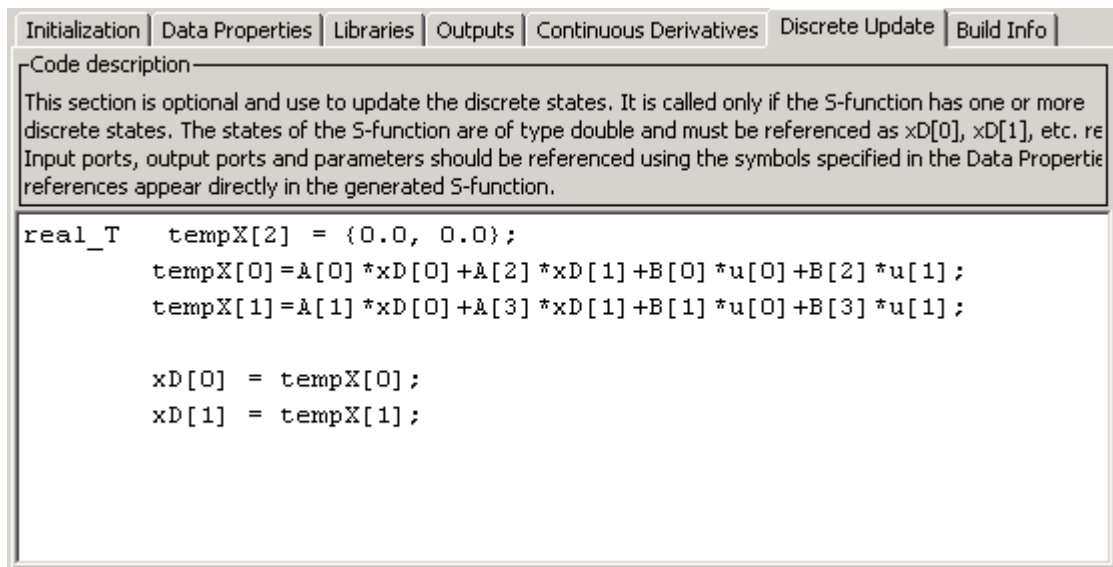

The screenshot shows the S-Function Builder interface with the 'Discrete Update' tab selected. The 'Code description' section contains the following text:

This section is optional and use to update the discrete states. It is called only if the S-function has one or more discrete states. The states of the S-function are of type double and must be referenced as xD[0], xD[1], etc. re Input ports, output ports and parameters should be referenced using the symbols specified in the Data Properties references appear directly in the generated S-function.

```
real_T    tempX[2] = {0.0, 0.0};
    tempX[0] = A[0] *xD[0] + A[2] *xD[1] + B[0] *u[0] + B[2] *u[1];
    tempX[1] = A[1] *xD[0] + A[3] *xD[1] + B[1] *u[0] + B[3] *u[1];

    xD[0] = tempX[0];
    xD[1] = tempX[1];
```

Building the State-Space Example

Click the **Build** button on the S-Function Builder to create an executable for this S-function. You can now run the model and compare the output to the original discrete state-space S-function contained in `sfcdemo_dsfunc`.

Basic C MEX S-Function

In this section...

“Introducing an Example of a Basic C MEX S-Function” on page 4-43

“Defines and Includes” on page 4-46

“Callback Method Implementations” on page 4-46

“Simulink/Simulink® Coder™ Interfaces” on page 4-48

“Building the Timestwo Example” on page 4-49

Introducing an Example of a Basic C MEX S-Function

This section presents an example of a C MEX S-function that you can use as a model for creating simple C S-functions. The example S-function `timestwo.c` outputs twice its input.

The following model uses the `timestwo` S-function to double the amplitude of a sine wave and plot it in a scope.

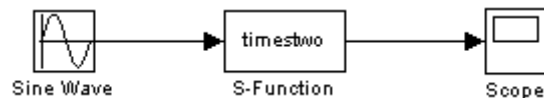

The block dialog for the S-function specifies `timestwo` as the S-function name; the parameters field is empty.

The `timestwo` S-function contains the S-function callback methods shown in this figure. At the end of S-function, include the code snippet as described in “Simulink/Simulink® Coder™ Interfaces” on page 4-48.

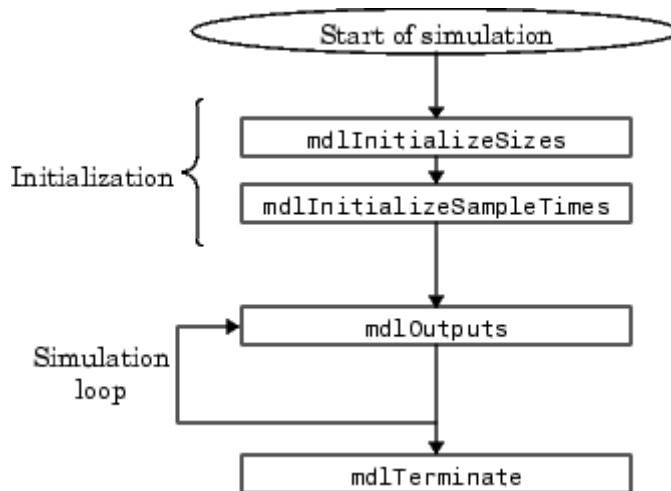

The contents of `timestwo.c` are shown below. A description of the code is provided after the example.

```

#define S_FUNCTION_NAME timestwo /* Defines and Includes */
#define S_FUNCTION_LEVEL 2

#include "simstruc.h"

static void mdlInitializeSizes(SimStruct *S)
{
    ssSetNumSFcnParams(S, 0);
    if (ssGetNumSFcnParams(S) != ssGetSFcnParamsCount(S)) {
        return; /* Parameter mismatch reported by the Simulink engine*/
    }

    if (!ssSetNumInputPorts(S, 1)) return;
    ssSetInputPortWidth(S, 0, DYNAMICALLY_SIZED);
    ssSetInputPortDirectFeedThrough(S, 0, 1);

    if (!ssSetNumOutputPorts(S,1)) return;
    ssSetOutputPortWidth(S, 0, DYNAMICALLY_SIZED);

    ssSetNumSampleTimes(S, 1);
  
```



```

        /* Take care when specifying exception free code - see sfuntmpl.doc */
        ssSetOptions(S, SS_OPTION_EXCEPTION_FREE_CODE);
    }

static void mdlInitializeSampleTimes(SimStruct *S)
{
    ssSetSampleTime(S, 0, INHERITED_SAMPLE_TIME);
    ssSetOffsetTime(S, 0, 0.0);
}

static void mdlOutputs(SimStruct *S, int_T tid)
{
    int_T i;
    InputRealPtrsType uPtrs = ssGetInputPortRealSignalPtrs(S,0);
    real_T *y = ssGetOutputPortRealSignal(S,0);
    int_T width = ssGetOutputPortWidth(S,0);

    for (i=0; i<width; i++) {
        *y++ = 2.0 *(*uPtrs[i]);
    }
}

static void mdlTerminate(SimStruct *S){}

#ifdef MATLAB_MEX_FILE /* Is this file being compiled as a MEX-file? */
#include "simulink.c" /* MEX-file interface mechanism */
#else
#include "cg_sfun.h" /* Code generation registration function */
#endif

```

This example has three parts:

- Defines and includes
- Callback method implementations
- Simulink (or Simulink Coder) product interfaces

Defines and Includes

The example starts with the following define statements.

```
#define S_FUNCTION_NAME timestwo
#define S_FUNCTION_LEVEL 2
```

The first `define` statement specifies the name of the S-function (`timestwo`). The second `define` statement specifies that the S-function is in the *Level 2* format (for more information about Level 1 and Level 2 S-functions, see “Convert Level-1 C MEX S-Functions” on page 4-100).

After defining these two items, the example includes `simstruc.h`, which is a header file that gives access to the `SimStruct` data structure and the MATLAB Application Program Interface (API) functions.

```
#define S_FUNCTION_NAME timestwo
#define S_FUNCTION_LEVEL 2
#include "simstruc.h"
```

The `simstruc.h` file defines a data structure, called the `SimStruct`, that the Simulink engine uses to maintain information about the S-function. The `simstruc.h` file also defines macros that enable your MEX file to set values in and get values (such as the input and output signal to the block) from the `SimStruct` (see “About `SimStruct` Functions” on page 10-2).

Callback Method Implementations

The next part of the `timestwo` S-function contains implementations of required callback methods.

mdlInitializeSizes

The Simulink engine calls `mdlInitializeSizes` to inquire about the number of input and output ports, sizes of the ports, and any other information (such as the number of states) needed by the S-function.

The `timestwo` implementation of `mdlInitializeSizes` specifies the following size information:

- Zero parameters

Therefore, the **S-function parameters** field of the S-Function Block Parameters dialog box must be empty. If it contains any parameters, the engine reports a parameter mismatch.

- One input port and one output port

The widths of the input and output ports are dynamically sized. This tells the engine that the S-function can accept an input signal of any width. By default, the widths of dynamically sized input and output port are equal when the S-function has only one input and output port.

- One sample time

The `mdlInitializeSampleTimes` callback method specifies the actual value of the sample time.

- Exception free code

Specifying exception-free code speeds up execution of your S-function. You must take care when specifying this option. In general, if your S-function is not interacting with the MATLAB environment, you can safely specify this option. For more details, see “Simulink Engine Interaction with C S-Functions” on page 4-76.

mdlInitializeSampleTimes

The Simulink engine calls `mdlInitializeSampleTimes` to set the sample times of the S-function. A `timestwo` block executes whenever the driving block executes. Therefore, it has a single inherited sample time, `INHERITED_SAMPLE_TIME`.

mdlOutputs

The engine calls `mdlOutputs` at each time step to calculate the block outputs. The `timestwo` implementation of `mdlOutputs` multiplies the input signal by 2 and writes the answer to the output.

The line:

```
InputRealPtrsType uPtrs = ssGetInputPortRealSignalPtrs(S,0);
```

accesses the input signal. The `ssGetInputPortRealSignalPtrs` macro returns a vector of pointers, which you *must* access using

```
*uPtrs[i]
```

For more details on accessing input signals, see “Accessing Signals Using Pointers” on page 4-85.

The line:

```
real_T *y = ssGetOutputPortRealSignal(S,0);
```

accesses the output signal. The `ssGetOutputPortRealSignal` macro returns a pointer to an array containing the block outputs.

The line:

```
int_T width = ssGetOutputPortWidth(S,0);
```

obtains the width of the signal passing through the block. The S-function loops over the inputs to compute the outputs.

mdlTerminate

The engine calls `mdlTerminate` to provide the S-function with an opportunity to perform tasks at the end of the simulation. This is a mandatory S-function routine. The `timestwo` S-function does not perform any termination actions, and this routine is empty.

Simulink/Simulink Coder Interfaces

At the end of the S-function, include the following code to attach your S-function to either the Simulink or Simulink Coder products.

```
#ifdef MATLAB_MEX_FILE
#include "simulink.c"
#else
#include "cg_sfun.h"
#endif
```

This trailer is required at the end of every S-function. If it is omitted, any attempt to compile your S-function will abort with a `failure during build of exports file` error message.

Building the Timestwo Example

To compile this S-function, enter

```
mex timestwo.c
```

at the command line. The `mex` command compiles and links the `timestwo.c` file to create a dynamically loadable executable for the Simulink software to use.

The resulting executable is referred to as a MEX S-function, where MEX stands for “MATLAB Executable.” The MEX file extension varies from platform to platform. For example, on a 32-bit Microsoft® Windows® system, the MEX file extension is `.mexw32`.

Templates for C S-Functions

In this section...
“About the Templates for C S-Functions” on page 4-50
“S-Function Source File Requirements” on page 4-50
“The SimStruct” on page 4-53
“Data Types in S-Functions” on page 4-53
“Compiling C S-Functions” on page 4-53

About the Templates for C S-Functions

Use one of the provided C MEX S-function templates as a starting point for creating your own S-function. The templates contain skeleton implementations of callback methods with comments that explain their use. The template file, `sfuntmpl_basic.c`, contains commonly used S-function routines. A template containing all available routines (as well as more comments) can be found in `sfuntmpl_doc.c` in the same folder.

Note We recommend that you use the C MEX file template when developing MEX S-functions.

S-Function Source File Requirements

This section describes requirements that every S-function source file must meet to compile correctly. The S-function templates meet these requirements.

Statements Required at the Top of S-Functions

For S-functions to operate properly, *each* source module of your S-function that accesses the `SimStruct` must contain the following sequence of defines and include

```
#define S_FUNCTION_NAME your_sfunction_name_here
#define S_FUNCTION_LEVEL 2
#include "simstruc.h"
```

where *your_sfunction_name_here* is the name of your S-function (i.e., what you enter in the S-Function Block Parameters dialog box). These statements give you access to the `SimStruct` data structure that contains pointers to the data used by the simulation. The included code also defines the macros used to store and retrieve data in the `SimStruct`, described in detail in “Convert Level-1 C MEX S-Functions” on page 4-100. In addition, the code specifies that you are using the Level-2 S-function format.

Note All S-functions from Simulink version 1.3 through version 2.1 are considered to be Level-1 S-functions. They are compatible with newer versions of the software, but we recommend that you write new S-functions in the Level-2 format.

The following headers are included by `simstruc.h` when compiling as a MEX file.

Header Files Included by `simstruc.h` When Compiling as a MEX File

Header File	Description
<code>matlabroot/extern/include/tmwtypes.h</code>	General data types, e.g., <code>real_T</code>
<code>matlabroot/simulink/include/simstruc_types.h</code>	<code>SimStruct</code> data types, e.g., <code>DTypeId</code>
<code>matlabroot/extern/include/mex.h</code>	MATLAB MEX file API routines to interface MEX files with the MATLAB environment
<code>matlabroot/extern/include/matrix.h</code>	MATLAB External Interface API routines to query and manipulate MATLAB matrices

When compiling your S-function for use with the Simulink Coder product, `simstruc.h` includes the following.

Header Files Included by `simstruc.h` When Used by the Simulink Coder Product

Header File	Description
<code>matlabroot/extern/include/tmwtypes.h</code>	General types, e.g., <code>real_T</code>
<code>matlabroot/simulink/include/simstruc_types.h</code>	SimStruct data types, e.g., <code>DTypeId</code>
<code>matlabroot/rtw/c/src/rt_matrx.h</code>	Macros for MATLAB API routines

Callback Methods That an S-Function Must Implement

Your S-function must implement the following functions (see “Write Callback Methods” on page 4-89):

- `mdlInitializeSizes` specifies the sizes of various parameters in the `SimStruct`, such as the number of output ports for the block.
- `mdlInitializeSampleTimes` specifies the sample time(s) of the block.
- `mdlOutputs` calculates the output of the block.
- `mdlTerminate` performs any actions required at the termination of the simulation. If no actions are required, this function can be implemented as a stub.

Statements Required at the Bottom of S-Functions

Your S-function must include the following trailer code at the end of the main module only.

```

#ifdef MATLAB_MEX_FILE /* Is this being compiled as MEX-file? */
#include "simulink.c" /* MEX-file interface mechanism */
#else
#include "cg_sfun.h" /* Code generation registration func */
#endif

```

These statements select the appropriate code for your particular application:

- `simulink.c` is included if the file is being compiled into a MEX- file.
- `cg_sfun.h` is included if the file is being used with the Simulink Coder product to produce a standalone or real-time executable.

Note This trailer code must not be in the body of any S-function routine.

The SimStruct

The file `simstruc.h` is a C language header file that defines the `SimStruct` data structure and its access macros. It encapsulates all the data relating to the model or S-function, including block parameters and outputs.

There is one `SimStruct` data structure allocated for the Simulink model. Each S-function in the model has its own `SimStruct` associated with it. The organization of these `SimStructs` is much like a folder tree. The `SimStruct` associated with the model is the *root* `SimStruct`. Any `SimStruct` associated with an S-function is a *child* `SimStruct`.

The Simulink product provides a set of macros that S-functions can use to access the fields of the `SimStruct`. See “About `SimStruct` Functions” on page 10-2 for more information.

Data Types in S-Functions

The file `tmwtypes.h` is a C language header file that defines a set of data types used in the S-function template and in the `SimStruct`. These data types, such as `real_T`, `uint32_T`, etc., provide a way to switch between different data types for 16, 32, and 64 bit systems, allowing greater platform independence and flexibility.

S-functions are not required to use these data types. For example, you can edit the example `csfunc.c` and change `real_T` to `double` and `int_T` to `int`. If you compile and simulate the S-function, the results will be identical to the results using the previous data types.

Compiling C S-Functions

Your S-function can be compiled in one of three modes, defined either by the `mex` command or by the Simulink Coder product when the S-function is built:

- `MATLAB_MEX_FILE` — Indicates that the S-function is being built as a MEX file for use with the Simulink product.

- RT — Indicates that the S-function is being built with the Simulink Coder product for a real-time application using a fixed-step solver.
- NRT — Indicates that the S-function is being built with the Simulink Coder product for a non-real-time application using a variable-step solver.

The build process you use automatically defines the mode for your S-function.

Integrate C Functions Using Legacy Code Tool

In this section...

“Overview” on page 4-55

“Example of Integrating Existing C Functions into Simulink Models with the Legacy Code Tool” on page 4-58

“Registering Legacy Code Tool Data Structures” on page 4-61

“Declaring Legacy Code Tool Function Specifications” on page 4-63

“Generating and Compiling the S-Functions” on page 4-71

“Generating a Masked S-Function Block for Calling a Generated S-Function” on page 4-72

“Forcing Simulink Accelerator Mode to Use S-Function TLC Inlining Code” on page 4-72

“Calling Legacy C++ Functions” on page 4-73

“Handling Multiple Registration Files” on page 4-73

“Deploying Generated S-Functions” on page 4-74

“Legacy Code Tool Examples” on page 4-74

“Legacy Code Tool Limitations” on page 4-75

Overview

You can integrate existing C (or C++) functions—for example, device drivers, lookup tables, and general functions and interfaces—into Simulink models by using the Legacy Code Tool. Using specifications that you supply as MATLAB code, the tool transforms existing functions into C MEX S-functions that you can include in Simulink models. If you use the Simulink Coder product to generate code from a model, the Legacy Code Tool can insert an appropriate call to your C function into the generated code. For details, see “Integrate External Code Using Legacy Code Tool”.

In comparison to using the S-Function Builder or writing an S-function, the Legacy Code Tool can be easier to use and it generates optimized code (does not generate wrapper code) often required by embedded systems. However, you should consider one of the alternate approaches for a hybrid system,

such as a system that includes a plant and controller, or a system component written in a language other than C or C++. Alternative approaches are more flexible in that they support more features and programming languages.

To interact with the Legacy Code Tool, you

- Use a Legacy Code Tool data structure to specify
 - A name for the S-function
 - Specifications for the existing C functions
 - Files and paths required for compilation
 - Options for the generated S-function
- Use the `legacy_code` function to
 - Initialize the Legacy Code Tool data structure for a given C function
 - Generate an S-function for use during simulation
 - Compile and link the generated S-function into a dynamically loadable executable
 - Generate a masked S-function block for calling the generated S-function
 - Generate a TLC block file and, if necessary, an `rtwmakecfg.m` file for code generation (Simulink Coder product license required)

Note Before you can use `legacy_code`, you must ensure that a C compiler is set up for your MATLAB installation. If you need to set up a compiler, enter the command `mex -setup` in the MATLAB command window.

The following diagram illustrates a general procedure for using the Legacy Code Tool. “Example of Integrating Existing C Functions into Simulink Models with the Legacy Code Tool” on page 4-58 provides an example that uses the Legacy Code Tool to transform an existing C function into a C MEX S-function.

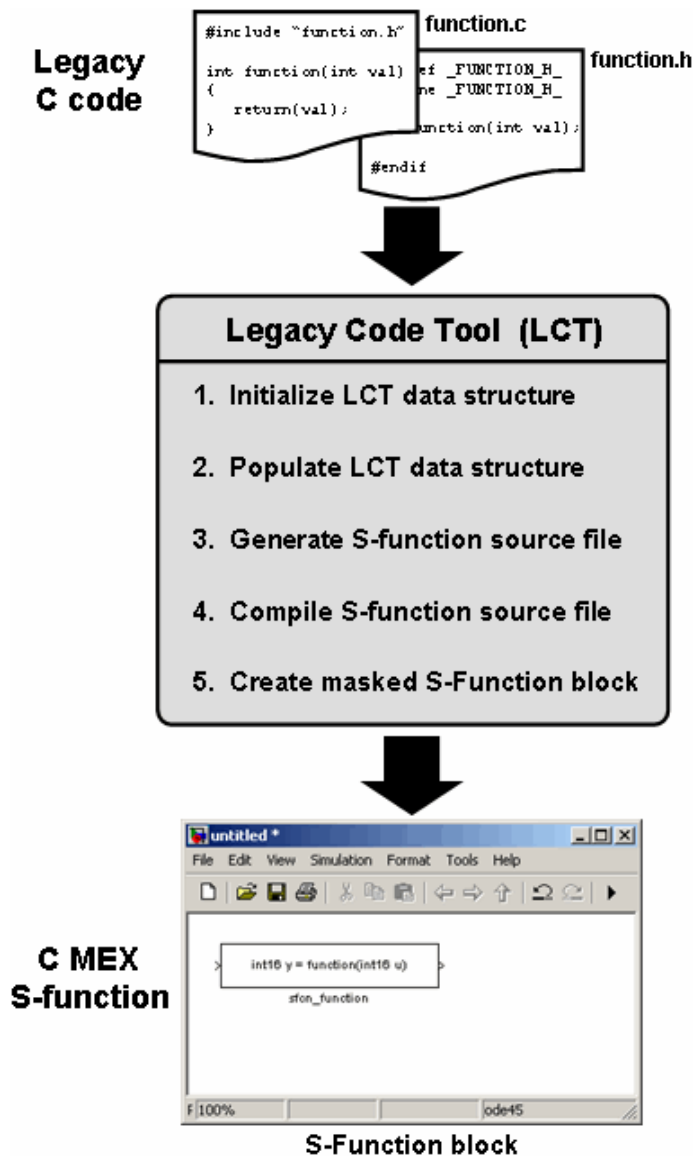

If you have a Simulink Coder product license, see “Integrate External Code Using Legacy Code Tool” for information on using the Legacy Code Tool for code generation.

Example of Integrating Existing C Functions into Simulink Models with the Legacy Code Tool

Suppose you have an existing C function that outputs the value of its floating-point input multiplied by two. The function is defined in a source file named `doubleIt.c`, and its declaration exists in a header file named `doubleIt.h` as shown here.

```
#include "doubleIt.h"

double doubleIt(double inVal)
{
    return(2 * inVal);
}
```

doubleIt.c

```
#ifndef _DOUBLEIT_H_
#define _DOUBLEIT_H_

double doubleIt(double inVal);

#endif
```

doubleIt.h

To use the Legacy Code Tool to incorporate this C function into a Simulink model as a C MEX S-function:

- 1 Use the `legacy_code` function to initialize a MATLAB structure with fields that represent Legacy Code Tool properties. For example, create a Legacy Code Tool data structure named `def` by entering the following command at the MATLAB command prompt:

```
def = legacy_code('initialize')
```

The Legacy Code Tool data structure named `def` displays its fields in the MATLAB command window as shown here:

```
def =

    SFunctionName: ''
 InitializeConditionsFcnSpec: ''
    OutputFcnSpec: ''
    StartFcnSpec: ''
    TerminateFcnSpec: ''
    HeaderFiles: {}
    SourceFiles: {}
    HostLibFiles: {}
```

```
TargetLibFiles: {}
  IncPaths: {}
  SrcPaths: {}
  LibPaths: {}
  SampleTime: 'inherited'
  Options: [1x1 struct]
```

- 2 Specify appropriate values for fields in the Legacy Code Tool data structure to identify properties of the existing C function. For example, specify the C function source and header filenames by entering the following commands at the MATLAB command prompt:

```
def.SourceFiles = {'doubleIt.c'};
def.HeaderFiles = {'doubleIt.h'};
```

You must also specify information about the S-function that the Legacy Code Tool produces from the C code. For example, specify a name for the S-function and its output function declaration by entering:

```
def.SFunctionName = 'ex_sfun_doubleit';
def.OutputFcnSpec = 'double y1 = doubleIt(double u1)';
```

See the `legacy_code` reference page for information about the various data structure fields.

- 3 Use the `legacy_code` function to generate an S-function source file from the existing C function. At the MATLAB command prompt, type:

```
legacy_code('sfcn_cmex_generate', def);
```

The Legacy Code Tool uses the information specified in `def` to create the S-function source file named `ex_sfun_doubleit.c` in the current MATLAB folder.

- 4 Make sure a C compiler is set up for your MATLAB installation. If you need to set up a compiler, enter the command `mex -setup` in the MATLAB command window.
- 5 Use the `legacy_code` function to compile and link the S-function source file into a dynamically loadable executable that the Simulink software can use. At the MATLAB command prompt, type:

```
legacy_code('compile', def);
```

The following messages appear in the MATLAB command window:

```
### Start Compiling ex_sfundoubleit
      mex('ex_sfundoubleit.c', 'd:\work\lct_demos\doubleIt.c',
          '-Id:\work\lct\lct_demos')
### Finish Compiling ex_sfundoubleit
### Exit
```

On a 32-bit Microsoft Windows system, the resulting S-function executable is named `ex_sfundoubleit.mexw32`.

- 6 Use the `legacy_code` function to insert a masked S-Function block into a Simulink model. The Legacy Code Tool configures the block to use the C MEX S-function created in the previous step. Also, the tool masks the block such that it displays the value of its `OutputFcnSpec` property (see the description of the `legacy_code` function). For example, create a new model containing a masked S-Function block by issuing the following command at the MATLAB command prompt:

```
legacy_code('slblock_generate', def);
```

The block appears in an empty model editor window as shown here:

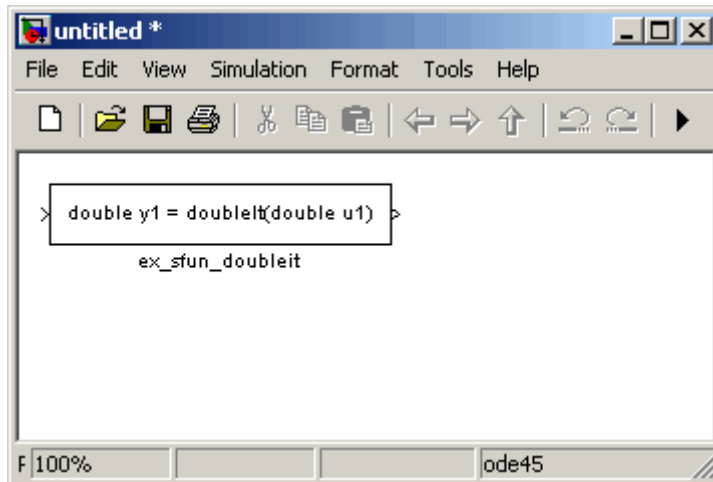

The following Simulink model demonstrates that the C MEX S-function produced by the Legacy Code Tool behaves like the C function `doubleIt`. In particular, the S-Function block named `ex_sfundoubleit` returns the value of its floating-point input multiplied by two.

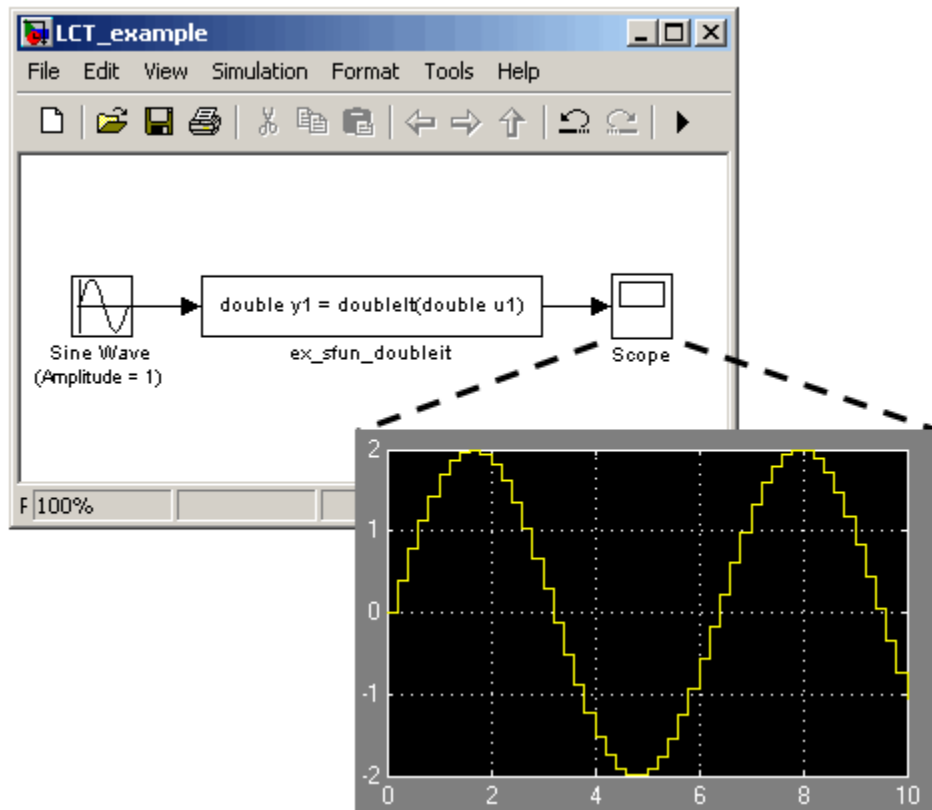

Registering Legacy Code Tool Data Structures

The first step to using the Legacy Code Tool is to register one or more MATLAB structures with fields that represent properties of the existing C code and the S-function being generated. The registration process is flexible. You can choose to set up resources and initiate registration in a variety of ways, including

- Placing all required header and source files in the current working folder or in a hierarchical folder structure
- Generating and placing one or more S-functions in the current working folder
- Having one or more registration files in the same folder

To register a Legacy Code Tool data structure:

- 1** Use the `legacy_code` function, specifying `'initialize'` as the first argument.

```
lct_spec = legacy_code('initialize')
```

The Legacy Code Tool data structure named `lct_spec` displays its fields in the MATLAB command window as shown below:

```
lct_spec =  
  
      SFunctionName: ''  
InitializeConditionsFcnSpec: ''  
      OutputFcnSpec: ''  
      StartFcnSpec: ''  
TerminateFcnSpec: ''  
      HeaderFiles: {}  
      SourceFiles: {}  
      HostLibFiles: {}  
TargetLibFiles: {}  
      IncPaths: {}  
      SrcPaths: {}  
      LibPaths: {}  
      SampleTime: 'inherited'  
      Options: [1x1 struct]
```

- 2** Define values for the data structure fields (properties) that apply to your existing C function and the S-function you intend to generate. Minimally, you must specify
 - Source and header files for the existing C function (`SourceFiles` and `HeaderFiles`)
 - A name for the S-function (`SFunctionName`)

- At least one function specification for the S-function (InitializeConditionsFcnSpec, OutputFcnSpec, StartFcnSpec, TerminateFcnSpec)

For a complete list and descriptions of the fields in the structure, see the `legacy_code` function reference page.

If you define fields that specify compilation resources and you specify relative paths, the Legacy Code Tool searches for the resources relative to the following directories, in the following order:

- 1 Current working folder
- 2 C-MEX S-function folder, if different than the current working folder
- 3 Directories you specify
 - `IncPaths` for header files
 - `SrcPaths` for source files
 - `LibPaths` for target and host libraries
- 4 Directories on the MATLAB search path, excluding toolbox directories

Declaring Legacy Code Tool Function Specifications

The `InitializeConditionsFcnSpec`, `OutputFcnSpec`, `StartFcnSpec`, and `TerminateFcnSpec` fields defined in the Legacy Code Tool data structure (see the description of the `legacy_code` function) require string values that adhere to a specific syntax format. The required syntax format enables the Legacy Code Tool to map the return value and arguments of an existing C function to the return value, inputs, outputs, parameters, and work vectors of the S-function that the tool generates.

General syntax

```
return-spec = function-name(argument-spec)
```

For example, the following string specifies a function named `doubleIt` with return specification `double y1` and input argument specification `double u1`.

```
def.OutputFcnSpec = 'double y1 = doubleIt(double u1)';
```

For more detail on declaring function specifications, see

- “Return Specification” on page 4-64
- “Function Name” on page 4-65
- “Argument Specification” on page 4-65
- “Supported Data Types” on page 4-68
- “Legacy Code Tool Function Specification Rules” on page 4-69
- “Legacy C Function Rules” on page 4-70

Return Specification

The return specification defines the data type and variable name for the return value of the existing C function.

return-type return-variable

<i>return-type</i>	A data type listed in “Supported Data Types” on page 4-68.
<i>return-variable</i>	Token of the form y_1, y_2, \dots, y_n , where n is the total number of output arguments.

If the function does not return a value, you can omit the return specification or specify it as `void`.

The following table shows valid function specification syntax for an integer return value. Use the table to identify the syntax you should use for your C function prototype.

Return Type	C Function Prototype	Legacy Code Tool Function Specification
No return value	<code>void myfunction(...)</code>	<code>void myfunction(...)</code>
Scalar value	<code>int = myfunction(...)</code>	<code>int16 y1 = myfunction(...)</code>

Function Name

The function name that you specify must be the same as your existing C function name.

For example, consider the following C function prototype:

```
float doubleIt(float inVal);
```

In this case, the function name in the Legacy Code Tool function specification must be `doubleIt`.

You should not specify the name of a C macro. If you must, set the field `Options.isMacro` to `true` in case expression folding is enabled.

Argument Specification

The argument specification defines one or more data type and token pairs that represent the input, output, parameter, and work vector arguments of the existing C function. The function input and output arguments map to block input and output ports and parameters map to workspace parameters.

argument-type argument-token

<i>argument-type</i>	A data type listed in “Supported Data Types” on page 4-68.
<i>argument-token</i>	Token of one of the following forms: <ul style="list-style-type: none"> • Input — u_1, u_2, \dots, u_n, where n is the total number of input arguments • Output — y_1, y_2, \dots, y_n, where n is the total number of output arguments • Parameter — p_1, p_2, \dots, p_n, where n is the total number of parameter arguments • Work vectors (persistent memory) — $work_1, work_2, \dots, work_n$, where n is the total number of work vector arguments

If the function has no arguments, you can omit the argument specification or specify it as `void`.

Consider the following C function prototype:

```
float powerIt(float inVal, int exponent);
```

To generate an S-function that calls the preceding function at each time step, you would set the Legacy Code Tool data structure field `OutputFcnSpec` to the following string:

```
'single y1 = powerIt(single u1, int16 p1)'
```

Using this function specification, the Legacy Code Tool maps the following:

Return Value or Argument...	of C Type...	To Token...	of Data Type...
Return value	float	y1	single
inVal	float	u1	single
exponent	int	p1	int16

The following table shows valid function specification syntax for arguments of type integer. Use the table to identify and then adapt the syntax you should use for your C function prototype.

Argument Type	C Function Prototype	Legacy Code Tool Function Specification
Input Arguments		
No arguments	function(void)	function(void)
Scalar pass by value	function(int in1)	function(int16 u1)
Scalar pass by pointer	function(int *in1)	function(int16 u1[1])
Fixed vector	function(int in1[10]) or function(int *in1)	function(int16 u1[10])
Variable vector	function(int in1[]) or function(int *in1)	function(int16 u1[])
Fixed matrix	function(int in1[15]) or function(int in1[]) or function(int *in1)	function(int16 u1[3][5])

Argument Type	C Function Prototype	Legacy Code Tool Function Specification
Variable matrix	function(int in1[]) or function(int *in1)	function(int16 u1[][])
Output Arguments		
Scalar pointer	function(int *y1)	function(int16 y1[1])
Fixed vector	function(int y1[10]) or function(int *y1)	function(int16 y1[10])
Fixed matrix	function(int y1[15]) or function(int y1[]) or function(int *y1)	function(int16 y1[3][5])
Parameter Arguments		
Scalar pass by value	function(int p1)	function(int16 p1)
Scalar pass by pointer	function(int *p1)	function(int16 p1[1])
Fixed vector	function(int p1[10]) or function(int *p1)	function(int16 p1[10])
Variable vector	function(int p1[]) or function(int *p1)	function(int16 p1[])
Fixed matrix	function(int p1[15]) or function(int p1[]) or function(int *p1)	function(int16 p1[3][5])
Variable matrix	function(int p1[]) or function(int *p1)	function(int16 p1[][])
Work Vector Arguments		
Scalar passed by value	function(int work1)	function(int16 work1)
Scalar pointer	function(int *work1) function(void *work1) function(void **work1)	function(int16 work1[1]) void function(void *work1) void function(void **work1)

Argument Type	C Function Prototype	Legacy Code Tool Function Specification
Fixed vector	function(int work1[10]) or function(int *work1)	function(int16 work1[10])
Fixed matrix	function(int work1[15]) or function(int work1[]) or function(int *work1)	function(int16 work1[3][5])

Supported Data Types

Data Type	Supported for Input and Output?	Supported for Parameters?	Supported for Work Vectors?
“Data Types Supported by Simulink”	Yes	Yes	Yes
Simulink.Bus ¹	Yes	Yes	Yes
Array of Simulink.Bus ²	Yes	No	Yes
Simulink.NumericType ³	Yes	Yes	Yes
Simulink.AliasType ¹	Yes	Yes	Yes
enum ¹	Yes	Yes	Yes
Fixed-point ⁴	Yes	Yes	Yes
Fi objects	N/A	Yes	N/A
Complex numbers ⁵	Yes	Yes	Yes
1-D array	Yes	Yes	Yes
2-D array ⁶	Yes	Yes	Yes
n-D array ⁷	Yes	Yes	Yes
void *	No	No	Yes
void **	No	No	Yes

1 You must supply the header file that declares the structure of the bus, declares the enum type, or defines the data type with the same name as an

alias. The structure of the bus declared in the header file must match the structure of the bus object (for example, the number and order of elements, data types and widths of elements, and so on). For an example, see `sldemo_lct_bus`.

- 2** A bus element can be complex, but only with Simulink built-in data types. Nesting of arrays to any level is also supported.
- 3** You must supply the header file that defines the data type only if the numeric data type is also an alias.
- 4** You must declare the data as a `Simulink.NumericType` object (unspecified scaling is not supported). For examples, see `sldemo_lct_fixpt_signals` and `sldemo_lct_fixpt_params`.
- 5** Limited to use with Simulink built-in data types. To specify a complex data type, enclose the built-in data type within angle brackets (`<>`) and prepend the word `complex` (for example, `complex<double>`). For an example, see `sldemo_lct_cplxgain`.
- 6** The MATLAB, Simulink, and Simulink Coder products store two-dimensional matrix data in column-major format as a vector. If your external function code is written for row-major data, transpose the matrix data in the MATLAB environment.
- 7** For a multidimensional signal, you can use the `size` function to determine the number of elements in the signal. For examples, see `sldemo_lct_lut` and `sldemo_lct_ndarray`.

For more information, see “Data Types Supported by Simulink”.

Legacy Code Tool Function Specification Rules

Specifications for the `legacy_code` must adhere to the following rules:

- If an argument is not scalar, you must pass the argument by reference.
- The numbering of input, output, parameter, and work vector argument tokens must start at 1 and increase monotonically.
- For a given Legacy Code Tool data structure, the data type and size of input, output, parameter, and work vector arguments must be the same across

function specifications for `StartFcnSpec`, `InitializeConditionsFcnSpec`, `OutputFcnSpec`, and `TerminateFcnSpec`.

- You can use the `size` function to
 - Get the size of any input, output, parameter, or work vector argument and pass the size as input to the legacy function
 - Specify the input argument dimensions as a function of other parameter argument dimensions
 - Specify the output or work vector argument dimensions as a function of other input or parameter argument dimensions

Consider the following example, which demonstrates both uses of the function:

```
def.OutputFcnSpec=  
'void foo(double p1[][], double u1[size(p1,2)], double y1[size(u1,1)], ...  
double work1[size(u1,1)], int32 size(u1,1))'
```

- `p1` is a two-dimensional parameter that is sized dynamically
- `u1` is a one-dimensional vector with the same number of elements as the second dimension of `p1`
- `y1` is a one-dimensional vector with the same number of element as `u1`
- `work1` is a one-dimensional vector with the same number of element as `u1`
- `int32 size(u1,1)` returns the number of elements in the vector `u1` as the fifth input argument

Legacy C Function Rules

To integrate a C function using the Legacy Code Tool, the function must adhere to the following rules:

- The function must not change the value of input arguments.
- The function's return value cannot be a pointer.
- Function specifications you define for the `StartFcnSpec`, `InitializeConditionsFcnSpec`, or `TerminateFcnSpec` cannot access input or output arguments.

Generating and Compiling the S-Functions

After you register a Legacy Code Tool data structure for an existing C function, use the `legacy_code` function as explained below to generate, compile, and link the S-function.

- 1 Generate a C MEX S-function based on the information defined in the structure. Call `legacy_code` with `'sfcn_cmex_generate'` as the first argument and the name of the data structure as the second argument.

```
legacy_code('sfcn_cmex_generate', lct_spec);
```

- 2 Make sure a C compiler is set up for your MATLAB installation. If you need to set up a compiler, enter the command `mex -setup` in the MATLAB command window.

- 3 Compile and link the S-function. This step assumes that a C compiler is set up for your MATLAB installation. Call `legacy_code` with `'compile'` as the first argument and the name of the data structure as the second argument.

```
legacy_code('compile', lct_spec);
```

Informational messages similar to the following appear in the MATLAB command window and a dynamically loadable executable results.

On a 32-bit Windows system, the Simulink software names the file `ex_sfun_doubleit.mexw32`.

```
### Start Compiling ex_sfun_doubleit
mex ex_sfun_doubleit.c -Id:\work\lct\lct_demos
### Finish Compiling ex_sfun_doubleit
### Exit
```

As a convenience, you can generate, compile, and link the S-function in a single step by calling `legacy_code` with the string `'generate_for_sim'`. The function also generates a TLC file for accelerated simulations, if the `Options.useTlcWithAccel` field of the Legacy Code Tool data structure is set to 1.

Once you have generated a dynamically loadable executable, you or others can use it in a model by adding an S-Function block that specifies the compiled S-function.

Generating a Masked S-Function Block for Calling a Generated S-Function

You have the option of using the Legacy Code Tool to generate a masked S-function block (graphical representation) that is configured to call a generated C MEX S-function. To generate such a block, call `legacy_code` with `'smblock_generate'` as the first argument and the name of the Legacy Code Tool data structure as the second argument.

```
legacy_code('smblock_generate', lct_spec);
```

The tool masks the block such that it displays the value of the `OutputFcnSpec` field. You can then add the block to a model manually.

If you prefer that the Legacy Code Tool add the block to a model automatically, specify the name of the model as a third argument. For example:

```
legacy_code('smblock_generate', lct_spec, 'myModel');
```

If the specified model (for example, `myModel`) exists, `legacy_code` opens the model and adds the masked S-function block described by the Legacy Code Tool data structure. If the model does not exist, the function creates a new model with the specified name and adds the masked S-function block.

Forcing Simulink Accelerator Mode to Use S-Function TLC Inlining Code

If you are using Simulink Accelerator mode, you can generate and force the use of TLC inlining code for the S-function generated by the Legacy Code Tool. To do this:

- 1 Generate a TLC block file for the S-function by calling the `legacy_code` function with `'sfcn_tlc_generate'` as the first argument and the name of the Legacy Code Tool data structure as the second argument.

```
legacy_code('sfcn_tlc_generate', lct_spec);
```

Consider the example in “Example of Integrating Existing C Functions into Simulink Models with the Legacy Code Tool” on page 4-58. To generate a TLC file for the model shown at the end of that example, enter the following command:

```
legacy_code('sfcn_tlc_generate', def);
```

- 2 Force Accelerator mode to use the TLC file by using the `ssSetOptions SimStruct` function to set the S-function option `SS_OPTION_USE_TLC_WITH_ACCELERATOR`.

Calling Legacy C++ Functions

To call a legacy C++ function after initializing the Legacy Code Tool data structure, assign the value 'C++' to the `Options.language` field. For example,

```
def = legacy_code('initialize');
def.Options.language = 'C++';
```

To verify the new setting, enter

```
def.Options.language
```

Note The Legacy Code Tool can interface with C++ functions, but not C++ objects. For a work around, see “Legacy Code Tool Limitations” on page 4-75 in the Simulink documentation.

Handling Multiple Registration Files

You can have multiple registration files in the same folder and generate an S-function for each file with a single call to `legacy_code`. Likewise, you can use a single call to `legacy_code` in order to compile and link the S-functions and another to generate corresponding TLC block files, if appropriate.

Consider the following example, where `lct_register_1`, `lct_register_2`, and `lct_register_3` each create and initialize fields of a Legacy Code Tool structure.

```
defs1 = lct_register_1;
defs2 = lct_register_2;
defs3 = lct_register_3;
defs = [defs1(:);defs2(:);defs3(:)];
```

You can then use the following sequence of calls to `legacy_code` in order to generate files based on the three registration files:

```
legacy_code('sfcn_cmex_generate', defs);  
legacy_code('compile', defs);  
legacy_code('sfcn_tlc_generate', defs);
```

Alternatively, you can process each registration file separately. For example:

```
defs1 = lct_register1;  
legacy_code('sfcn_cmex_generate', defs1);  
legacy_code('compile', defs1);  
legacy_code('sfcn_tlc_generate', defs1);  
. . .  
defs2 = lct_register2;  
legacy_code('sfcn_cmex_generate', defs2);  
legacy_code('compile', defs2);  
legacy_code('sfcn_tlc_generate', defs2);  
. . .  
defs3 = lct_register3;  
legacy_code('sfcn_cmex_generate', defs3);  
legacy_code('compile', defs3);  
legacy_code('sfcn_tlc_generate', defs3);
```

Deploying Generated S-Functions

You can deploy the S-functions that you generate with the Legacy Code Tool for use by others. To deploy an S-function for simulation use only, you need to share only the compiled dynamically loadable executable.

Legacy Code Tool Examples

For examples that show applications of the Legacy Code Tool, in the MATLAB command window, type:

```
demo simulink
```

Legacy Code Tool examples are listed in **Modeling Features > Custom Blocks with S-functions and Legacy Code Tool**.

Legacy Code Tool Limitations

Legacy Code Tool

- Generates C MEX S-functions for existing functions written in C or C++. The tool does not support transformation of MATLAB or Fortran functions.
- Can interface with C++ functions, but not C++ objects. One way of working around this limitation is to use the S-Function Builder to generate the shell of an S-function and then call the legacy C++ code from the S-function's `mdlOutputs` callback function.
- Does not support simulating continuous or discrete states. This prevents you from using the `mdlUpdate` and `mdlDerivatives` callback functions. If your application requires this support, see “Using the S-Function Builder to Incorporate Legacy Code” on page 2-17.
- Always sets the S-functions flag for direct feedthrough (`sizes.DirFeedthrough`) to `true`. Due to this setting and the preceding limitation, the generated S-function cannot break algebraic loops.
- Supports only the continuous, but fixed in minor time step, sample time and offset option.
- Supports complex numbers, but only with Simulink built-in data types.
- Does not support use of function pointers as the output of the legacy function being called.
- Does not support the following S-function features:
 - Work vectors, other than general `DWork` vectors
 - Frame-based input and output signals
 - Port-based sample times
 - Multiple block-based sample times

Simulink Engine Interaction with C S-Functions

In this section...
“Introduction” on page 4-76
“Process View” on page 4-76
“Data View” on page 4-84

Introduction

This section examines how the Simulink engine interacts with S-functions from two perspectives:

- **Process perspective**, i.e., at which points in a simulation the engine invokes the S-function.
- **Data perspective**, i.e., how the engine and the S-function exchange information during a simulation.

Process View

The following figures show the order in which the Simulink engine invokes the callback methods in an S-function. Solid rectangles indicate callbacks that always occur during model initialization or at every time step. Dotted rectangles indicate callbacks that may occur during initialization and/or at some or all time steps during the simulation loop. See the documentation for each callback method to determine the exact circumstances under which the engine invokes the callback.

Note The process view diagram represents the execution of S-functions that contain continuous and discrete states, enable zero-crossing detection, and reside in a model that uses a variable-step solver. Different solvers omit certain steps in the diagram. For a better understanding of how the Simulink engine executes your particular S-function, run the model containing the S-function using the Simulink debugger. For more information, see “Introduction to the Debugger”.

In the following model initialization loop, the Simulink engine configures the S-function for an upcoming simulation. The engine always makes the required calls to `mdlInitializeSizes` and `mdlInitializeSampleTime` to set up the fundamental attributes of the S-function, including input and output ports, S-function dialog parameters, work vectors, sample times, etc.

The engine calls additional methods, as needed, to complete the S-function initialization. For example, if the S-function uses work vectors, the engine calls `mdlSetWorkWidths`. Also, if the `mdlInitializeSizes` method deferred setting up input and output port attributes, the engine calls any methods necessary to complete the port initialization, such as `mdlSetInputPortWidth`, during signal propagation. The `mdlStart` method calls the `mdlCheckParameters` and `mdlProcessParameters` methods if the S-function uses dialog parameters.

Model Initialization

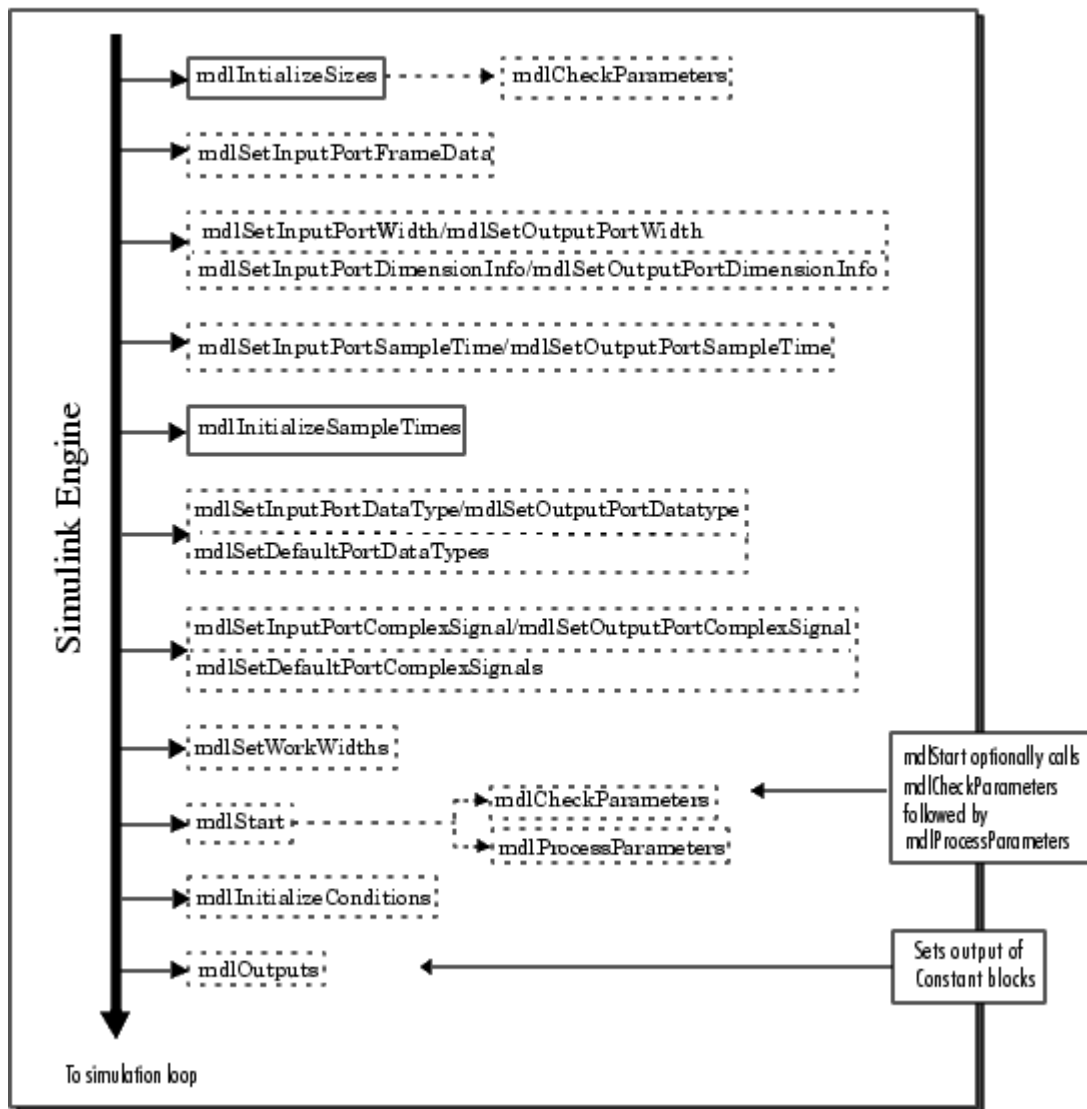

Note The `mdlInitializeSizes` callback method also runs when you enter the name of a compiled S-function into the S-Function Block Parameters dialog box.

After initialization, the Simulink engine executes the following simulation loop. If the simulation loop is interrupted, either manually or when an error occurs, the engine jumps directly to the `mdlTerminate` method. If the simulation was manually halted, the engine first completes the current time step before invoking `mdlTerminate`.

Simulation Loop

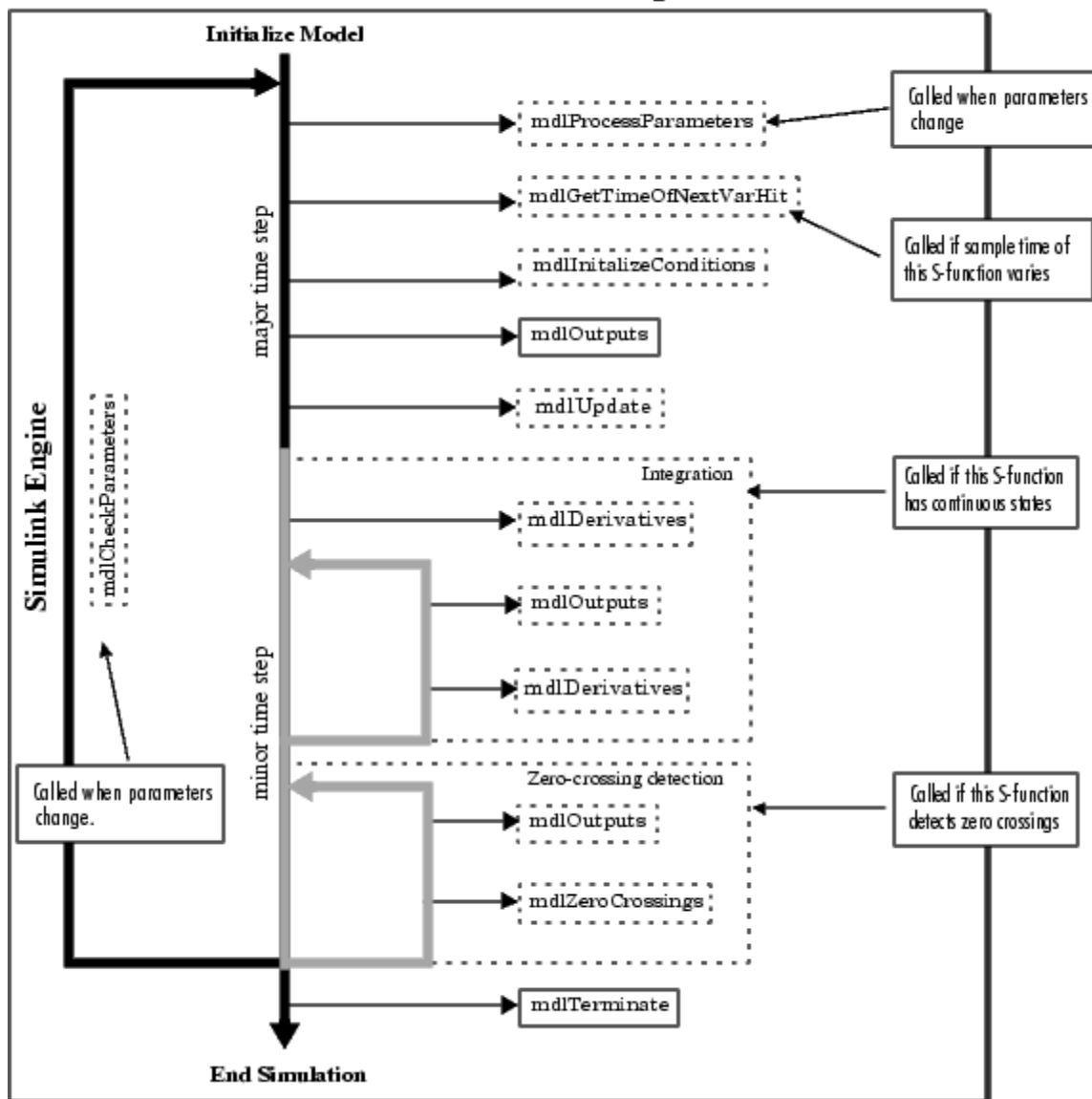

If your model contains multiple S-Function blocks, the engine invokes a particular method for every S-function before proceeding to the next method. For example, the engine calls all the `mdlInitializeSizes` methods before calling any `mdlInitializeSampleTimes` methods. The engine uses the block sorted order to determine the order to execute the S-functions. See “What Is Sorted Order?” in *Using Simulink* to learn more about how the engine determines the block sorted order.

Calling Structure for Code Generation

If you use the Simulink Coder product to generate code for a model containing S-functions, the Simulink engine does not execute the entire calling sequence outlined above. Initialization proceeds as outlined above until the engine reaches the `mdlStart` method. The engine then calls the S-function methods shown in the following figure, where the `mdlRTW` method is unique to the Simulink Coder product.

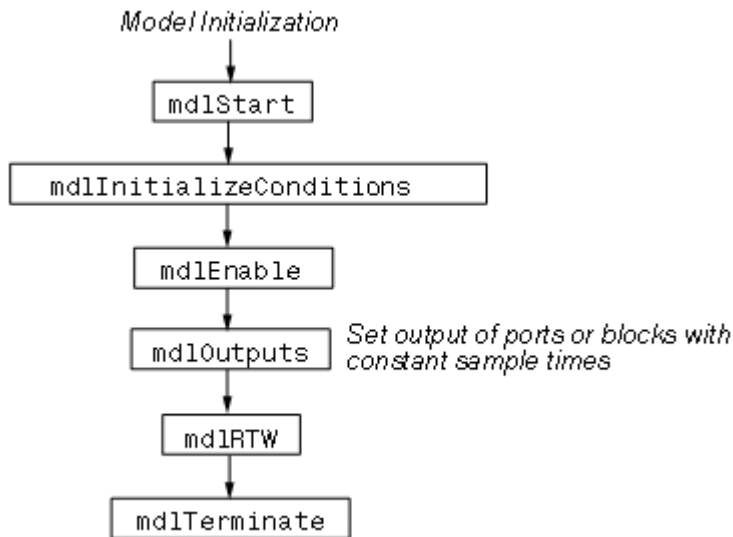

If the S-function resides in a conditionally executed subsystem, it is possible for the generated code to interleave calls to `mdlInitializeConditions` and `mdlStart`. Consider the following Simulink model `sfcn_demo_enablesub`.

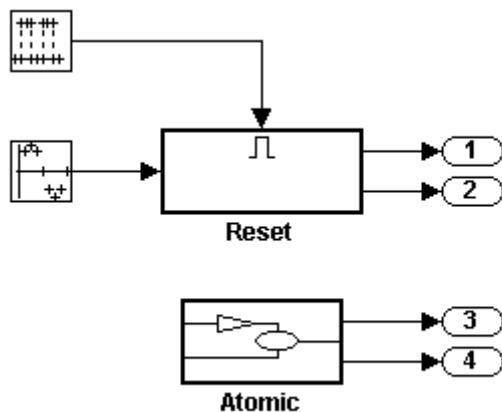

The model contains two nonvirtual subsystems, the conditionally executed enabled subsystem named `Reset` and the atomic subsystem named `Atomic`. Each subsystem contains an S-Function block that calls the S-function `dsfunc.c`, which models a discrete state-space system with two states. The enabled subsystem `Reset` resets the state values when the subsystem is enabled, and the output values when the subsystem is disabled.

Using the generic real-time (GRT) target, the generated code for the model-wide `Start` function calls the `Start` functions of the two subsystems before calling the model-wide `MdlInitialize` function, as shown in the following code:

```
void MdlStart(void)
{
    /* snip */

    /* Start for enabled SubSystem: '<Root>/Reset' */
    sfcn_demo_enablesub_Reset_Start();

    /* end of Start for SubSystem: '<Root>/Reset' */

    /* Start for atomic SubSystem: '<Root>/Atomic' */
    sfcn_demo_enablesub_Atomic_Start();
}
```

```
/* end of Start for SubSystem: '<Root>/Atomic' */
```

```
MdlInitialize();
```

The Start function for the enabled subsystem calls the subsystem's InitializeConditions function:

```
void sfcndemo_enablesub_Reset_Start(void)
{
    sfcndemo_enablesub_Reset_Init();
    /* snip */
}
```

The MdlInitialize function, called in MdlStart, contains a call to the InitializeConditions function for the atomic subsystem:

```
void MdlInitialize(void)
{
    /* InitializeConditions for atomic SubSystem:
       '<Root>/Atomic' */

    sfcndemo_enablesub_Atomic_Init();
}
```

Therefore, the model-wide Start function interleaves calls to the Start and InitializeConditions functions for the two subsystems and the S-functions they contain.

For more information about the Simulink Coder product and how it interacts with S-functions, see “About S-Functions and Code Generation”.

Alternate Calling Structure for External Mode

When you are running a Simulink model in external mode, the calling sequence for S-function routines changes as shown in the following figure.

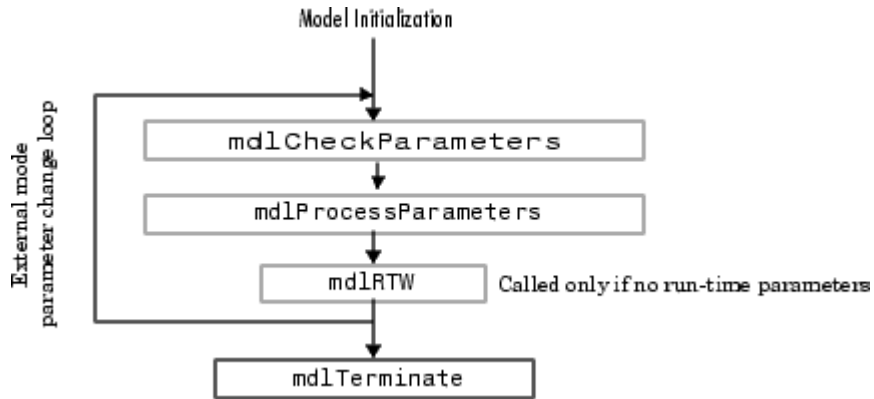

The engine calls `mdlRTW` once when it enters external mode and again each time a parameter changes or when you select **Simulation > Update Diagram**.

Note Running a Simulink model in external mode requires the Simulink Coder product.

Data View

S-function blocks have input and output signals, parameters, and internal states, plus other general work areas. In general, block inputs and outputs are written to, and read from, a block I/O vector. Inputs can also come from

- External inputs via the root Inport blocks
- Ground if the input signal is unconnected or grounded

Block outputs can also go to the external outputs via the root Outport blocks. In addition to input and output signals, S-functions can have

- Continuous states
- Discrete states
- Other working areas such as real, integer, or pointer work vectors

You can parameterize S-function blocks by passing parameters to them using the S-Function Block Parameters dialog box.

The following figure shows the general mapping between these various types of data.

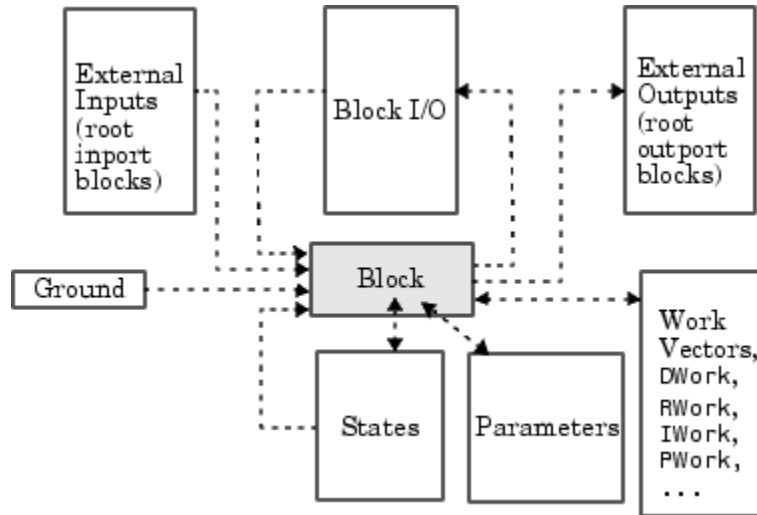

An S-function's `mdlInitializeSizes` routine sets the sizes of the various signals and vectors. S-function methods called during the simulation loop can determine the sizes and values of the signals.

An S-function method can access input signals in two ways:

- Via pointers
- Using contiguous inputs

Accessing Signals Using Pointers

During the simulation loop, access the input signals using

```
InputRealPtrsType uPtrs =
    ssGetInputPortRealSignalPtrs(S, portIndex)
```

This returns an array of pointers for the input port with index *portIndex*, where *portIndex* starts at 0. There is one array of pointers for each input port. To access an element of this array you must use

```
*uPtrs[element]
```

The following figure describes how to access the input signals of an S-function with two inputs.

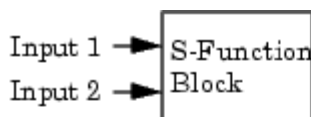

To access Input 1:

```
InputRealPtrsType uPtrs0 = ssGetInputPortRealSignalPtrs(S,0)
```

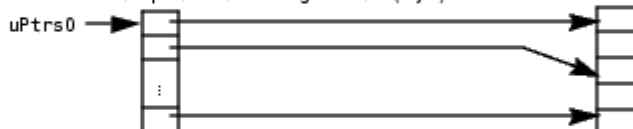

To access Input 2:

```
InputRealPtrsType uPtrs1 = ssGetInputPortRealSignalPtrs(S,1)
```

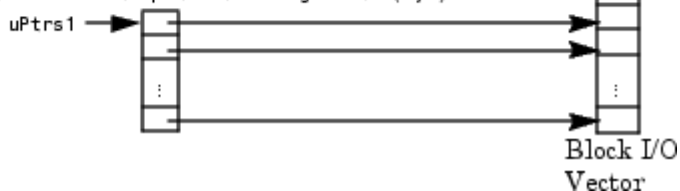

As shown in the previous figure, the input array pointers can point at noncontiguous places in memory.

You can retrieve the output signal by using this code.

```
real_T *y = ssGetOutputPortSignal(S,outputPortIndex);
```

Accessing Contiguous Input Signals

An S-function's `mdlInitializeSizes` method can specify that the elements of its input signals must occupy contiguous areas of memory, using `ssSetInputPortRequiredContiguous`. If the inputs are contiguous, other methods can use `ssGetInputPortSignal` to access the inputs.

Accessing Input Signals of Individual Ports

This section describes how to access all input signals of a particular port and write them to the output port. The preceding figure shows that the input array of pointers can point to noncontiguous entries in the block I/O vector. The output signals of a particular port form a contiguous vector. Therefore, the correct way to access input elements and write them to the output elements (assuming the input and output ports have equal widths) is to use this code.

```
int_T element;
int_T portWidth = ssGetInputPortWidth(S,inputPortIndex);
InputRealPtrsType uPtrs = ssGetInputPortRealSignalPtrs(S,inputPortIndex);
real_T *y = ssGetOutputPortSignal(S,outputPortIdx);

for (element=0; element<portWidth; element++) {
    y[element] = *uPtrs[element];
}
```

A common mistake is to try to access the input signals via pointer arithmetic. For example, if you were to place

```
real_T *u = *uPtrs; /* Incorrect */
```

just below the initialization of `uPtrs` and replace the inner part of the above loop with

```
*y++ = *u++; /* Incorrect */
```

the code compiles, but the MEX file might crash the Simulink software. This is because it is possible to access invalid memory (which depends on how you build your model). When accessing the input signals incorrectly, a crash occurs when the signals entering your S-function block are not contiguous. Noncontiguous signal data occurs when signals pass through virtual connection blocks such as the Mux or Selector blocks.

To verify that your S-function correctly accesses wide input signals, pass a replicated signal to each input port of your S-function. To do this, create a Mux block with the number of input ports equal to the width of the desired signal entering your S-function. Then, connect the driving source to each S-function input port, as shown in the following figure. Finally, run your S-function using this input signal to verify that it does not crash and produces expected results.

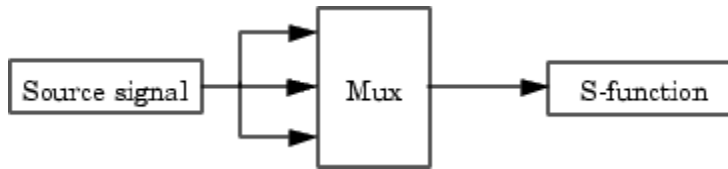

Write Callback Methods

Writing an S-function basically involves creating implementations of the callback functions that the Simulink engine invokes during a simulation. For guidelines on implementing a particular callback, see the documentation for the callback. For information on using callbacks to implement specific block features, such as parameters or sample times, see “Implement Block Features”.

S-Functions in Normal Mode Referenced Models

Note For additional information, see “Model Referencing Limitations”.

When a C S-function appears in a referenced model that executes in Normal mode, successful execution is impossible if all of the following are true:

- The S-function has both an `mdlProcessParameters` function and an `mdlStart` function.
- The `mdlProcessParameters` function depends on the `mdlStart` function.
- The referenced model calls `mdlProcessParameters` before calling `mdlStart`.

Execution fails because `mdlProcessParameters` has dependency requirements that `mdlStart` has not satisfied. Automated analysis cannot guard against all possible causes of such failure: you must check your code manually and verify that `mdlProcessParameters` is not in any way dependent on `mdlStart` being called first. Examples of such dependency include:

- Allocating memory in `mdlStart` and using that memory in `mdlProcessParameters`. This is often done using `ssSetUserData` and `ssGetUserData`.
- Initializing any DWork or any global memory in `mdlStart` and reading the values in `mdlProcessParameters`.

To remind you to check for any such dependency problems, an error message appears by default for any S-function that is used in a Normal mode referenced model and contains both an `mdlProcessParameters` function and an `mdlStart` function. The error message does not mean that any dependency problems exist, but only that they might exist.

If you get such an error message, check for any problematic dependencies in the S-function, and recode as needed to eliminate them. When no such dependencies exist, you can safely suppress the error message and use the S-function in a Normal mode referenced model. To certify that the S-function is compliant, and the message is therefore unnecessary, include the following statement in `mdlInitializeSizes`:

```
ssSetModelReferenceNormalModeSupport (S, MDL_START_AND_MDL_PROCESS_PARAMS_OK);
```

For information about referenced models, see “Overview of Model Referencing”.

Supporting the Use of Multiple Instances of Referenced Models That Are in Normal Mode

You may need to modify S-functions that are used by a model so that the S-functions work with multiple instances of referenced models in Normal mode. The S-functions must indicate explicitly that they support multiple `exec` instances.

- For C S-functions, use `ssSupportsMultipleExecInstances(s, true)`.
- For MATLAB file S-functions, use `blockSupportMultipleExecInstances = true`.

The limitations for using S-functions with multiple instances of referenced models in Normal mode are the same as the limitations that apply to using S-functions with For Each Subsystem block.

Debug C MEX S-Functions

In this section...
“About Debugging C MEX S-Functions” on page 4-92
“Debug in Simulink Environment” on page 4-92
“Debug Using Third-Party Software” on page 4-96

About Debugging C MEX S-Functions

This section provides high-level tips on how to debug C MEX S-functions within the Simulink environment and using third-party software. The following lists highlight some of the more common errors made when writing an S-function. For a more detailed analysis, use the debugger provided with your C compiler.

The examples at the end of this section show how to debug a C MEX S-function during simulation, using third-party software.

- The first example uses the Microsoft Visual C++® .NET (version 7.0) environment.
- The second example debugs an S-function on The Open Group UNIX® platform.

Refer to your compiler documentation for further information on debugging files.

Debug in Simulink Environment

Before you begin, make sure you have a good understanding of how to write C S-functions and the required callback methods. For assistance:

- Read the section “Available S-Function Implementations” on page 2-2 to determine if you implemented your S-function using the most appropriate method.
- Use the S-Function Builder block to generate simple S-functions and study the contents of the source files.

- Inspect the S-function example models available in `sfundemos`. The folder `matlabroot/simulink/src` contains the S-function source files for these models.

If your S-function is not compiling, first ensure that the `mex` command is properly configured and your S-function includes all necessary files:

- Run `mex -setup` to ensure that your compiler is correctly installed.
- Confirm that you are passing all the source files needed by your S-function to the `mex` command.
- Check that these additional source files are on the MATLAB path.
- Make sure that your S-function includes the `simstruc.h` header file. If you are accessing legacy code, make sure that any header files needed by that code are also included in your S-function.
- Make sure that your S-function does not include the `simstruc_types.h` or `rtwtypes.h` header files. These Simulink and Simulink Coder header files are automatically included for you. If you are compiling your S-function as a MEX file for simulation, including the `rtwtypes.h` file results in errors.

If the `mex` command compiles your S-function, but your S-function does not simulate or the simulation produces incorrect results, inspect your S-function source code to ensure that:

- You are not overwriting important memory
- You are not using any uninitialized variables

The following table describes additional common S-function constructs that can lead to compilation and simulation errors.

Does your S-function...	Look for...
Use for loops to assign memory?	Instances where your S-function might inadvertently assign values outside of the array bounds.
Use global variables?	Locations in the code where the global variables can be corrupted. If you have multiple instances of your S-function in a model, they can write over the same memory location.
Allocate memory?	Memory your S-function does not deallocate. Always free memory that your S-function allocates, using the <code>malloc</code> and <code>free</code> commands to allocate and deallocate memory, respectively.
Have direct feedthrough?	<p>An incorrect direct feedthrough flag setting in your S-function. An S-function can access its inputs in the <code>mdlOutputs</code> method only if it specifies that the input ports have direct feedthrough. Accessing input signals in <code>mdlOutputs</code> when the input port direct feedthrough flag is set to <code>false</code> leads to indeterminate behavior. To check if you have a direct feedthrough flag incorrectly set, you can turn on the model property <code>TryForcingSFcnDF</code> using the command</p> <pre data-bbox="739 1083 1248 1107">set_param(model_name, 'TryForcingSFcnDF', 'on')</pre> <p>This command specifies that all S-functions in the model <code>model_name</code> have a direct feedthrough flag of <code>true</code> for all their input ports. After you turn on this property, if your simulation produces correct answers without causing an algebraic loop, one of your S-functions in the model potentially set an incorrect direct feedthrough flag. Consult the file <code>sfuntmpl_directfeed.txt</code> for more information on diagnosing direct feedthrough errors.</p>

Does your S-function...	Look for...
Access input signals correctly?	<p>Instances in the code where your S-function uses incorrect macros to access input signals, for example when accessing a discontinuous signal. Discontinuous signals result when an S-function input port is fed by a Selector block that selects every other element of a vector signal. For discontinuous input signals, use the following commands:</p> <pre data-bbox="739 591 1222 774"> // In mdlInitializeSizes ssSetInputPortRequiredContiguous(S, 0, 0); // In mdlOutputs, access the inputs using InputRealPtrsType uPtrs1 = ssGetInputPortRealSignalPtrs(S,0); </pre> <p>For contiguous input signals, use the following commands:</p> <pre data-bbox="739 913 1258 1194"> // In mdlInitializeSizes ssSetInputPortRequiredContiguous(S, 0, 1); // In mdlOutputs, access the inputs using const real_T *u0 = (const real_T*) ssGetInputPortSignal(S,0); /* If ssSetInputPortRequiredContiguous is 0, ssGetInputPortSignal returns an invalid pointer.*/ </pre>

Debugging Techniques

You can use the following techniques for additional assistance with debugging your S-function.

- Compile the S-function in debug mode using the `-g` option for the `mex` command. This enables additional diagnostics features that are called only when you compile your S-function in debug mode.

- Place `ssPrintf` statements inside your callback methods to ensure that they are running and that they are executing in the order you expect. Also, use `ssPrintf` statements to print return values to the MATLAB command prompt to check if your code is producing the expected results.
- Type feature `memstats` at the MATLAB command prompt to query the memory usage.
- Use the MATLAB File & folder Comparisons tool, or other text differencing application, to look for textual changes in different versions of your S-function. This can help you locate changes that disabled an S-function that previously compiled and ran. See “Comparing Files and Folders” for instructions on how to use the File & folder Comparisons tool.
- Use settings on the Configuration Parameters dialog box to check for memory problems.
 - Set the **Solver data inconsistency** diagnostic to warning.
 - Set the **Array bounds exceeded** diagnostic to warning or error. (See “Checking Array Bounds” on page 8-72 for more information on how to use this diagnostic.)
 - Turn the **Signal storage reuse** optimization off.
- Separate the S-function’s algorithm from its Simulink interface then use the S-Function Builder to generate a new Simulink interface for the algorithm. The S-Function Builder ensures that the interface is implemented in the most consistent method.

Debug Using Third-Party Software

You can debug and profile the algorithm portion of your S-function using third-party software if you separate the algorithm from the S-function’s Simulink interface. You cannot debug and profile the S-function’s interface with the Simulink engine because the Simulink interface code does not ship with the product.

You can additionally use third-party software to debug an S-function during simulation, as shown in the following two examples. These examples use the Simulink model `sfcn_demo_timestwo` and the C MEX S-function `timestwo.c`.

Debugging C MEX S-Functions Using the Microsoft Visual C++ .NET Environment

Before beginning the example, save the files `sfcdemo_timestwo` and `timestwo.c` into your working folder.

- 1 Open the Simulink model `sfcdemo_timestwo`.
- 2 Create a version of the MEX file that you can debug by compiling the C file using the `mex` command with the `-g` option.

```
mex -g timestwo.c
```

The `-g` option creates the executable `timestwo.mexw32` with debugging symbols included. At this point, you may want to simulate the `sfcdemo_timestwo` model to ensure it runs properly.

- 3 Without exiting the MATLAB environment, start the Microsoft Development Environment.
- 4 From the Microsoft Development Environment menu bar, select **Tools > Debug Processes**.
- 5 In the **Processes** dialog box that opens:
 - a Select the `MATLAB.exe` process in the **Available Processes** list.
 - b Click **Attach**.
- 6 In the **Attach to Process** dialog box that opens:
 - a Select **Native** in the list of program types to debug.
 - b Click **OK**.

You should now be attached to the MATLAB process.

- 7 Click **Close** on the **Processes** dialog box.
- 8 From the Microsoft Development Environment **File** menu, select **Open > File**. Select the `timestwo.c` source files from the file browser that opens.
- 9 Set a breakpoint on the desired line of code by right-clicking on the line and selecting **Insert Breakpoint** from the context menu. If you have not previously run the model, the breakpoint may show up with a question

mark, indicating that the executable is not loaded. Subsequently running the model loads the `.mexw32` file and removes the question mark from the breakpoint.

- 10 Start the simulation from the `sfcndemo_timestwo` Simulink model. You should be running the S-function in the Microsoft Development Environment and can debug the file within that environment.

Debugging C MEX S-Functions on The Open Group UNIX Platforms

Before beginning the example, save the files `sfcndemo_timestwo` and `timestwo.c` into your working folder.

Create a version of the MEX file for debugging:

- 1 Open the Simulink model `sfcndemo_timestwo`.
- 2 Create a version of the MEX file that you can debug by compiling the C file using the `mex` command with the `-g` option:

```
mex -g timestwo.c
```

The `-g` option creates the executable `timestwo.mexa64` with debugging symbols included.

- 3 Simulate the `sfcndemo_timestwo` model to ensure it runs properly.
- 4 Exit the MATLAB environment.

Debug the MEX file:

- 1 Start the MATLAB environment in debugging mode using this command:

```
matlab -D<nameOfDebugger>
```

The `-D` flag starts the MATLAB environment within the specified debugger. For example, to use the `gdb` debugging tool on the Linux® platform, enter this command.

```
matlab -Dgdb
```

- 2 Once the debugger has loaded, continue loading the MATLAB environment by typing `run` at the debugger prompt (`gdb`).

```
run -nodesktop
```

```
Starting program: matlab
```

```
...
```

Note The debugger might stop on spurious segmentation violation signals that result from interactions with the underlying Java® Virtual Machine (JVM™). You can ignore these messages and continue, using the `cont` command. If you are not debugging segmentation violation signals and want to suppress these messages, enter the command `handle SIGSEGV nostop noprint pass`.

- 3 Open the `sfcndemo_timestwo` Simulink model.
- 4 Press **Ctrl+C** to open the debugger.
- 5 At the (`gdb`) prompt, set breakpoints in the source code, for example:

```
break timestwo.c:37
```

```
Breakpoint 1 (timestwo.c:37) pending  
(gdb)
```

- 6 At the (`gdb`) prompt, enter the `cont` command to continue.

```
cont
```

- 7 Use your debugger routines to debug the S-function. For more information, see the `gdb` documentation that is part of your operating system documentation.

Convert Level-1 C MEX S-Functions

In this section...

“Guidelines for Converting Level-1 C MEX S-Functions to Level-2” on page 4-100

“Obsolete Macros” on page 4-103

Guidelines for Converting Level-1 C MEX S-Functions to Level-2

Level-2 S-functions were introduced with Simulink version 2.2. Level-1 S-functions refer to S-functions that were written to work with Simulink version 2.1 and previous releases. Level-1 S-functions are compatible with Simulink version 2.2 and subsequent releases; you can use them in new models without making any code changes. However, to take advantage of new features in S-functions, Level-1 S-functions must be updated to Level-2 S-functions. Here are some guidelines:

- Start by looking at `simulink/src/sfunctmpl_doc.c`. This template S-function file concisely summarizes Level-2 S-functions.
- At the top of your S-function file, add this define:

```
#define S_FUNCTION_LEVEL 2
```

- Update the contents of `mdlInitializeSizes`. In particular, add the following error handling for the number of S-function parameters:

```
ssSetNumSFcnParams(S, NPARAMS); /*Number of expected parameters*/
if (ssGetNumSFcnParams(S) != ssGetSFcnParamsCount(S)) {
    /* Return if number of expected != number of actual parameters */
    return;
}
Set up the inputs using:
if (!ssSetNumInputPorts(S, 1)) return; /*Number of input ports */
ssSetInputPortWidth(S, 0, width);      /* Width of input
                                         port one (index 0)*/
ssSetInputPortDirectFeedThrough(S, 0, 1); /* Direct feedthrough
                                         or port one */
```



```

ssSetInputPortRequiredContiguous(S, 0);
Set up the outputs using:
if (!ssSetNumOutputPorts(S, 1)) return;
ssSetOutputPortWidth(S, 0, width);    /* Width of output port
                                         one (index 0) */

```

- If your S-function has a nonempty `mdlInitializeConditions`, update it to the following form:

```

#define MDL_INITIALIZE_CONDITIONS
static void mdlInitializeConditions(SimStruct *S)
{
}

```

Otherwise, delete the function.

- Access the continuous states using `ssGetContStates`. The `ssGetX` macro has been removed.
- Access the discrete states using `ssGetRealDiscStates(S)`. The `ssGetX` macro has been removed.
- For mixed continuous and discrete state S-functions, the state vector no longer consists of the continuous states followed by the discrete states. The states are saved in separate vectors and hence might not be contiguous in memory.
- The `mdlOutputs` prototype has changed from

```

static void mdlOutputs( real_T *y, const real_T *x,
    const real_T *u, SimStruct *S, int_T tid)

```

to

```

static void mdlOutputs(SimStruct *S, int_T tid)

```

Since `y`, `x`, and `u` are not explicitly passed in to Level-2 S-functions, you must use

- `ssGetInputPortSignal` to access inputs
- `ssGetOutputPortSignal` to access the outputs
- `ssGetContStates` or `ssGetRealDiscStates` to access the states

- The mdlUpdate function prototype has changed from

```
void mdlUpdate(real_T *x, real_T *u, SimStruct *S, int_T tid)
```

to

```
void mdlUpdate(SimStruct *S, int_T tid)
```

- If your S-function has a nonempty mdlUpdate, update it to this form:

```
#define MDL_UPDATE
static void mdlUpdate(SimStruct *S, int_T tid)
{
}
```

Otherwise, delete the function.

- If your S-function has a nonempty mdlDerivatives, update it to this form:

```
#define MDL_DERIVATIVES
static void mdlDerivatives(SimStruct *S)
{
}
```

Otherwise, delete the function.

- Replace all obsolete SimStruct macros. See “Obsolete Macros” on page 4-103 for a complete list of obsolete macros.
- When converting Level-1 S-functions to Level-2 S-functions, you should build your S-functions with full (i.e., highest) warning levels. For example, if you have gcc on a UNIX¹ system, use these options with the mex utility.

```
mex CC=gcc CFLAGS=-Wall sfcn.c
```

If your system has Lint, use this code.

```
lint -DMATLAB_MEX_FILE -I<matlabroot>/simulink/include
    -Imatlabroot/extern/include sfcn.c
```

1. UNIX is a registered trademark of The Open Group in the United States and other countries.

On a PC, to use the highest warning levels, you must create a project file inside the integrated development environment (IDE) for the compiler you are using. Within the project file, define `MATLAB_MEX_FILE` and add

```
matlabroot/simulink/include
matlabroot/extern/include
```

to the path (be sure to build with alignment set to 8).

Obsolete Macros

The following macros are obsolete. Replace each obsolete macro with the macro specified in the following table.

Obsolete Macro	Replace with
<code>ssGetU(S)</code> , <code>ssGetUPtrs(S)</code>	<code>ssGetInputPortSignalPtrs(S,port)</code> , <code>ssGetInputPortSignal(S,port)</code>
<code>ssGetY(S)</code>	<code>ssGetOutputPortRealSignal(S,port)</code>
<code>ssGetX(S)</code>	<code>ssGetContStates(S)</code> , <code>ssGetRealDiscStates(S)</code>
<code>ssGetStatus(S)</code>	Normally not used, but <code>ssGetErrorStatus(S)</code> is available.
<code>ssSetStatus(S,msg)</code>	<code>ssSetErrorStatus(S,msg)</code>
<code>ssGetSizes(S)</code>	Specific call for the wanted item (i.e., <code>ssGetNumContStates(S)</code>)
<code>ssGetMinStepSize(S)</code>	No longer supported
<code>ssGetPresentTimeEvent(S,sti)</code>	<code>ssGetTaskTime(S,sti)</code>
<code>ssGetSampleTimeEvent(S,sti)</code>	<code>ssGetSampleTime(S,sti)</code>
<code>ssSetSampleTimeEvent(S,t)</code>	<code>ssSetSampleTime(S,sti,t)</code>
<code>ssGetOffsetTimeEvent(S,sti)</code>	<code>ssGetOffsetTime(S,sti)</code>
<code>ssSetOffsetTimeEvent(S,sti,t)</code>	<code>ssSetOffsetTime(S,sti,t)</code>
<code>ssIsSampleHitEvent(S,sti,tid)</code>	<code>ssIsSampleHit(S,sti,tid)</code>
<code>ssGetNumInputArgs(S)</code>	<code>ssGetNumSFcnParams(S)</code>
<code>ssSetNumInputArgs(S,numInputArgs)</code>	<code>ssSetNumSFcnParams(S,numInputArgs)</code>
<code>ssGetNumArgs(S)</code>	<code>ssGetSFcnParamsCount(S)</code>

Obsolete Macro	Replace with
<code>ssGetArg(S, argNum)</code>	<code>ssGetSFcnParam(S, argNum)</code>
<code>ssGetNumInputs</code>	<code>ssGetNumInputPorts(S)</code> and <code>ssGetInputPortWidth(S, port)</code>
<code>ssSetNumInputs</code>	<code>ssSetNumInputPorts(S, nInputPorts)</code> and <code>ssSetInputPortWidth(S, port, val)</code>
<code>ssGetNumOutputs</code>	<code>ssGetNumOutputPorts(S)</code> and <code>ssGetOutputPortWidth(S, port)</code>
<code>ssSetNumOutputs</code>	<code>ssSetNumOutputPorts(S, nOutputPorts)</code> and <code>ssSetOutputPortWidth(S, port, val)</code>

Creating C++ S-Functions

The procedure for creating C++ S-functions is nearly the same as that for creating C S-functions. The following sections explain the differences.

- “Create a C++ Source File” on page 5-2
- “Make C++ Objects Persistent” on page 5-3
- “Build C++ S-Functions” on page 5-5
- “C++ References” on page 5-6

Create a C++ Source File

To create a C++ S-function from a C S-function, refer to a C++ reference. See “C++ References” on page 5-6.

In addition, set up the MEX function to use a C++ compiler (see “Build MEX-Files”)

Make C++ Objects Persistent

Your C++ callback methods might need to create persistent C++ objects, that is, objects that continue to exist after the method exits. For example, a callback method might need to access an object created during a previous invocation. Or one callback method might need to access an object created by another callback method. To create persistent C++ objects in your S-function:

- 1 Create a pointer work vector to hold pointers to the persistent object between method invocations:

```
static void mdlInitializeSizes(SimStruct *S)
{
    ...
    ssSetNumPWork(S, 1); // reserve element in the pointers vector
                        // to store a C++ object
    ...
}
```

- 2 Store a pointer to each object that you want to be persistent in the pointer work vector:

```
static void mdlStart(SimStruct *S)
{
    ssGetPWork(S)[0] = (void *) new counter; // store new C++ object in the
                                           // pointers vector
}
```

- 3 Retrieve the pointer in any subsequent method invocation to access the object:

```
static void mdlOutputs(SimStruct *S, int_T tid)
{
    counter *c = (counter *) ssGetPWork(S)[0]; // retrieve C++ object from
    real_T *y = ssGetOutputPortRealSignal(S,0); // the pointers vector and
    y[0] = c->output(); // use member functions of
} // the object
```

4 Destroy the objects when the simulation terminates:

```
static void mdlTerminate(SimStruct *S)
{
    counter *c = (counter *) ssGetPWork(S)[0]; // retrieve and destroy C++
    delete c; // object in the termination
} // function
```

Build C++ S-Functions

Use the `mex` command to build C++ S-functions exactly the way you use it to build C S-functions. For example, to build the C++ version of the `sfun_counter_cpp.cpp` file, enter

```
mex sfun_counter_cpp.cpp
```

at the MATLAB command prompt.

Note The extension of the source file for a C++ S-function must be `.cpp` to ensure that the compiler treats the contents of the file as C++ code.

C++ References

- [1] Meyers, S., *More Effective C++*, Boston, Addison-Wesley, 1996, Item 34
- [2] Oualline, S., *Practical C++ Programming*, Sebastopol, California, O'Reilly, 1995, Chapter 27
- [3] Stroustrup, B., *The C++ Programming Language*, 3rd Ed., Boston, Addison-Wesley, 1997, Appendix B

Creating Fortran S-Functions

- “Level-1 Versus Level-2 S-Functions” on page 6-2
- “Create Level-1 Fortran S-Functions” on page 6-3
- “Create Level-2 Fortran S-Functions” on page 6-8
- “Port Legacy Code” on page 6-18

Level-1 Versus Level-2 S-Functions

There are two main strategies to executing Fortran code from the Simulink software. One is from a Level-1 Fortran-MEX (F-MEX) S-function, the other is from a Level-2 gateway S-function written in C. Each has its advantages and both can be incorporated into code generated by the Simulink Coder product. If you have Simulink Coder, to have complete code generation with the software, you must inline the Fortran S-function. For more information, see “Inlining S-Functions”.

The original S-function interface was called the Level-1 API. As the Simulink product grew, the S-function API was rearchitected into the more extensible Level-2 API. This allows S-functions to have all the capabilities of a full Simulink model (except automatic algebraic loop identification and solving).

Note The Level-1 API supports creation of S-functions having only continuous sample time. If you want to create a Fortran S-function with a discrete sample time, you must use the Level-2 API.

For more information, see:

- “Create Level-1 Fortran S-Functions” on page 6-3
- “Create Level-2 Fortran S-Functions” on page 6-8

Create Level-1 Fortran S-Functions

In this section...

“Fortran MEX Template File” on page 6-3

“Example of a Level-1 Fortran S-Function” on page 6-3

“Inline Code Generation Example” on page 6-6

Fortran MEX Template File

A template file for Fortran MEX S-functions is located at `sfuntmpl_fortran.F`. The template file compiles as is and copies the input to the output.

To use the template to create a new Fortran S-function:

- 1 Create a copy under another filename.
- 2 Edit the copy to perform the operations you need.
- 3 Compile the edited file into a MEX-file, using the `mex` command.
- 4 Include the MEX-file in your model, using the S-Function block.

Example of a Level-1 Fortran S-Function

The example file, `sfun_timestwo_for.F`, implements an S-function that multiplies its input by 2.

```
C
C File: SFUN_TIMESTWO_FOR.F
C
C Abstract:
C   A sample Level-1 FORTRAN representation of a
C   timestwo S-function.
C
C   The basic mex command for this example is:
C
C   >> mex sfun_timestwo_for.F simulink.F
C
C   Copyright 1990-2002 The MathWorks, Inc.
```

```
C
C
C
C=====
C   Function:  SIZES
C
C   Abstract:
C     Set the size vector.
C
C     SIZES returns a vector which determines model
C     characteristics. This vector contains the
C     sizes of the state vector and other
C     parameters. More precisely,
C     SIZE(1) number of continuous states
C     SIZE(2) number of discrete states
C     SIZE(3) number of outputs
C     SIZE(4) number of inputs
C     SIZE(5) number of discontinuous roots in
C             the system
C     SIZE(6) set to 1 if the system has direct
C             feedthrough of its inputs,
C             otherwise 0
C
C=====
C
C   SUBROUTINE SIZES(SIZE)
C     .. Array arguments ..
C     INTEGER*4      SIZE(*)
C     .. Parameters ..
C     INTEGER*4      NSIZES
C     PARAMETER      (NSIZES=6)
C
C     SIZE(1) = 0
C     SIZE(2) = 0
C     SIZE(3) = 1
C     SIZE(4) = 1
C     SIZE(5) = 0
C     SIZE(6) = 1
C
C     RETURN
```

```

      END

C
C=====
C
C   Function:  OUTPUT
C
C   Abstract:
C     Perform output calculations for continuous
C     signals.
C
C=====
C   .. Parameters ..
C   SUBROUTINE OUTPUT(T, X, U, Y)
C     REAL*8      T
C     REAL*8      X(*), U(*), Y(*)

C
C     Y(1) = U(1) * 2.0

C
C     RETURN
C   END

C
C=====
C
C   Stubs for unused functions.
C
C=====

      SUBROUTINE INITCOND(X0)
C
C     REAL*8      X0(*)
C --- Nothing to do.
C     RETURN
C   END

      SUBROUTINE DERIVS(T, X, U, DX)
C
C     REAL*8      T, X(*), U(*), DX(*)
C --- Nothing to do.
C     RETURN
C   END
```

```
        SUBROUTINE DSTATES(T, X, U, XNEW)
        REAL*8          T, X(*), U(*), XNEW(*)
C --- Nothing to do.
        RETURN
        END

        SUBROUTINE DOUTPUT(T, X, U, Y)
        REAL*8          T, X(*), U(*), Y(*)
C --- Nothing to do.
        RETURN
        END

        SUBROUTINE TSAMPL(T, X, U, TS, OFFSET)
        REAL*8          T,TS,OFFSET,X(*),U(*)
C --- Nothing to do.
        RETURN
        END

        SUBROUTINE SINGUL(T, X, U, SING)
        REAL*8          T, X(*), U(*), SING(*)
C --- Nothing to do.
        RETURN
        END
```

A Level-1 S-function's input/output is limited to using the `REAL*8` data type, (`DOUBLE PRECISION`), which is equivalent to a `double` in C. Of course, the internal calculations can use whatever data types you need.

To see how this S-function works, enter

```
sfcndemo_timestwo_for
```

at the MATLAB command prompt and run the model.

Inline Code Generation Example

Simulink Coder users can use the sample block target file `sfun_timestwo_for.tlc` to generate inlined code for

`sfcndemo_timestwo_for`. If you want to learn how to inline your own Fortran MEX-file, see “Inlining S-Functions” in the Simulink Coder documentation.

Create Level-2 Fortran S-Functions

In this section...
“About Creating Level-2 Fortran S-Functions” on page 6-8
“Template File” on page 6-8
“C/Fortran Interfacing Tips” on page 6-8
“Constructing the Gateway” on page 6-13
“Example C MEX S-Function Calling Fortran Code” on page 6-16

About Creating Level-2 Fortran S-Functions

To use the features of a Level-2 S-function with Fortran code, you must write a skeleton S-function in C that has code for interfacing to the Simulink software and also calls your Fortran code.

Using the C MEX S-function as a gateway is quite simple if you are writing the Fortran code from scratch. If instead you have legacy Fortran code that exists as a standalone simulation, there is some work to be done to identify parts of the code that need to be registered with the Simulink software, such as identifying continuous states if you are using variable-step solvers or getting rid of static variables if you want to have multiple copies of the S-function in a Simulink model (see “Port Legacy Code” on page 6-18).

Template File

The file `sfuntmpl_gate_fortran.c` contains a template for creating a C MEX-file S-function that invokes a Fortran subroutine in its `mdlOutputs` method. It works with a simple Fortran subroutine if you modify the Fortran subroutine name in the code. The template allocates `DWork` vectors to store the data that communicates with the Fortran subroutine. See “How to Use `DWork` Vectors” on page 7-7 for information on setting up `DWork` vectors.

C/Fortran Interfacing Tips

The following are some tips for creating the C-to-Fortran gateway S-function.

MEX Environment

Remember that `mex -setup` needs to find both the MATLAB, C, and the Fortran compilers, but it can work with only one of these compilers at a time. If you install or change compilers, you must run `mex -setup` between other `mex` commands.

Test the installation and setup using sample MEX-files from the MATLAB, C, and Fortran MEX examples in `matlabroot/extern/examples/mex`, as well as S-function examples.

If using a C compiler on a Microsoft Windows platform, test the `mex` setup using the following commands and the example C source code file, `yprime.c`, in `matlabroot\extern\examples\mex`.

```
cd([matlabroot ' \extern\examples\mex' ])  
mex yprime.c
```

If using a Fortran compiler, test the `mex` setup using the following commands and the example Fortran source code files, `yprime.F` and `yprimefg.F`, in `matlabroot\extern\examples\mex`.

```
cd([matlabroot ' \extern\examples\mex' ])  
mex yprimef.f yprimefg.f
```

For more information, see Building MEX-Files.

Compiler Compatibility

Your C and Fortran compilers need to use the same object format. If you use the compilers explicitly supported by the `mex` command this is not a problem. When you use the C gateway to Fortran, it is possible to use Fortran compilers not supported by the `mex` command, but only if the object file format is compatible with the C compiler format. Common object formats include ELF and COFF.

The compiler must also be configurable so that the caller cleans up the stack instead of the callee. **Intel**[®] Visual Fortran (the replacement for Compaq[®] Visual Fortran) has the default stack cleanup as the caller.

Symbol Decorations

Symbol decorations can cause run-time errors. For example, `g77` decorates subroutine names with a trailing underscore when in its default configuration. You can either recognize this and adjust the C function prototype or alter the Fortran compiler's name decoration policy via command-line switches, if the compiler supports this. See the Fortran compiler manual about altering symbol decoration policies.

If all else fails, use utilities such as `od` (octal dump) to display the symbol names. For example, the command

```
od -s 2 <file>
```

lists strings and symbols in binary (`.obj`) files.

These binary utilities can be obtained for the Windows platform as well. The MKS, Inc. company provides commercial versions of powerful utilities for The Open Group UNIX platforms. Additional utilities can also be obtained free on the Web. `hexdump` is another common program for viewing binary files. As an example, here is the output of

```
od -s 2 sfun_atmos_for.o
```

on a Linux platform.

```
0000115 E€
0000136 E€
0000271 E€
0000467 E€@
0000530 E€
0000575 E€ E 5@
0001267 Cf VC- :C
0001323 :|. -:8ç#8 Kw6
0001353 ?333@
0001364 333
0001414 01.01
0001425 GCC: (GNU) egcs-2.91.66 19990314/
0001522 .symtab
0001532 .strtab
0001542 .shstrtab
```

```
0001554 .text
0001562 .rel.text
0001574 .data
0001602 .bss
0001607 .note
0001615 .comment
0003071 sfun_atmos_for.for
0003101 gcc2_compiled.
0003120 rearth.0
0003131 gmr.1
0003137 htab.2
0003146 ttab.3
0003155 ptab.4
0003164 gtab.5
0003173 atmos_
0003207 exp
0003213 pow_d
```

Note that Atmos has been changed to `atmos_`, which the C program must call to be successful.

With Visual Fortran on 32-bit Windows machines, the symbol is suppressed, so that Atmos becomes ATMOS (no underscore).

Fortran Math Library

Fortran math library symbols might not match C math library symbols. For example, A^B in Fortran calls library function `pow_dd`, which is not in the C math library. In these cases, you must tell `mex` to link in the Fortran math library. For gcc environments, these routines are usually found in `/usr/local/lib/libf2c.a`, `/usr/lib/libf2c.a`, or equivalent.

The `mex` command becomes

```
mex -L/usr/local/lib -lf2c cmex_c_file fortran_object_file
```

Note On a UNIX system, the `-lf2c` option follows the conventional UNIX library linking syntax, where `-l` is the library option itself and `f2c` is the unique part of the library file's name, `libf2c.a`. Be sure to use the `-L` option for the library search path, because `-I` is only followed while searching for include files.

The `f2c` package can be obtained for the Windows and UNIX environments from the Internet. The file `libf2c.a` is usually part of `g77` distributions, or else the file is not needed as the symbols match. In obscure cases, it must be installed separately, but even this is not difficult once the need for it is identified.

On 32-bit Windows machines, using Microsoft Visual C++ and Intel Visual Fortran 10.1, this example can be compiled using the following two `mex` commands. Enter each command on one line. The `mex -setup` command must be run to return to the C compiler before executing the second command. In the second command, replace the variable `IFORT_COMPILER10` with the name of the system's environment variable pointing to the Visual Fortran 10.1 root folder on your system.

```
mex -v -c fullfile(matlabroot,'toolbox','simulink','simdemos','simfeatures',
'srcFortran','sfun_atmos_sub.F'), -f fullfile(matlabroot,'bin','win32',
'mexopts','intelf10msvs2005opts.bat'))
```

```
!mex -v -L"%IFORT_COMPILER10%\IA32\LIB" -llibifcoremd -lifconsol
-lifportmd -llibmmd -llibirc sfun_atmos.c sfun_atmos_sub.obj
```

On 64-bit Windows machines, using Visual C++ and Visual Fortran 10.1, this example can be compiled using the following two `mex` commands (each command is on one line). The `mex -setup` command must be run to return to the C compiler before executing the second command. The variable `IFORT_COMPILER10` is the name of the system's environment variable pointing to the Visual Fortran 10.1 root folder and may vary on your system. Replace *matlabroot* with the path name to your MATLAB root folder.

```
mex -v -c fullfile(matlabroot,'toolbox','simulink','simdemos','simfeatures',
'srcFortran','sfun_atmos_sub.F'), -f fullfile(matlabroot,'bin','win64','mexopts',
'intelf10msvs2005opts.bat'))
```

```
!mex -v -L"%IFORT_COMPILER10%\EM64T\LIB" -llibifcoremd -lifconsol  
-lifportmd -llibmmd -llibirc sfun_atmos.c sfun_atmos_sub.obj
```

CFortran

Or you can try using CFortran to create an interface. CFortran is a tool for automated interface generation between C and Fortran modules, in either direction. Search the Web for cfortran or visit

<http://www-zeus.desy.de/~burow/cfortran/>

for downloading.

Choosing a Fortran Compiler

On a Windows machine, using Visual C++ with Fortran is best done with Visual Fortran 10.1.

For an up-to-date list of all the supported compilers, see the MathWorks supported and compatible compiler list at:

http://www.mathworks.com/support/compilers/current_release/

s

Constructing the Gateway

The `mdlInitializeSizes` and `mdlInitializeSampleTimes` methods are coded in C. It is unlikely that you will need to call Fortran routines from these S-function methods. In the simplest case, the Fortran is called only from `mdlOutputs`.

Simple Case

The Fortran code must at least be callable in one-step-at-a-time fashion. If the code doesn't have any states, it can be called from `mdlOutputs` and no `mdlDerivatives` or `mdlUpdate` method is required.

Code with States

If the code has states, you must decide whether the Fortran code can support a variable-step solver or not. For fixed-step solver only support, the C gateway consists of a call to the Fortran code from `mdlUpdate`, and outputs are cached in an S-function `DWork` vector so that subsequent calls by the Simulink engine into `mdlOutputs` will work properly and the Fortran code won't be called until the next invocation of `mdlUpdate`. In this case, the states in the code can be stored however you like, typically in the work vector or as discrete states.

If instead the code needs to have continuous time states with support for variable-step solvers, the states must be registered and stored with the engine as doubles. You do this in `mdlInitializeSizes` (registering states), then the states are retrieved and sent to the Fortran code whenever you need to execute it. In addition, the main body of code has to be separable into a call form that can be used by `mdlDerivatives` to get derivatives for the state integration and also by the `mdlOutputs` and `mdlUpdate` methods as appropriate.

Setup Code

If there is a lengthy setup calculation, it is best to make this part of the code separable from the one-step-at-a-time code and call it from `mdlStart`. This can either be a separate `SUBROUTINE` called from `mdlStart` that communicates with the rest of the code through `COMMON` blocks or argument I/O, or it can be part of the same piece of Fortran code that is isolated by an `IF-THEN-ELSE` construct. This construct can be triggered by one of the input arguments that tells the code if it is to perform either the setup calculations or the one-step calculations.

SUBROUTINE Versus PROGRAM

To be able to call Fortran from the Simulink software directly without having to launch processes, etc., you must convert a Fortran `PROGRAM` into a `SUBROUTINE`. This consists of three steps. The first is trivial; the second and third can take a bit of examination.

- 1 Change the line `PROGRAM` to `SUBROUTINE subName`.

Now you can call it from C using C function syntax.

- 2 Identify variables that need to be inputs and outputs and put them in the `SUBROUTINE` argument list or in a `COMMON` block.

It is customary to strip out all hard-coded cases and output dumps. In the Simulink environment, you want to convert inputs and outputs into block I/O.

- 3 If you are converting a standalone simulation to work inside the Simulink environment, identify the main loop of time integration and remove the loop and, if you want the Simulink engine to integrate continuous states, remove any time integration code. Leave time integrations in the code if you intend to make a discrete time (sampled) S-function.

Arguments to a SUBROUTINE

Most Fortran compilers generate SUBROUTINE code that passes arguments by reference. This means that the C code calling the Fortran code must use only pointers in the argument list.

```
PROGRAM ...
```

becomes

```
SUBROUTINE somename( U, X, Y )
```

A SUBROUTINE never has a return value. You manage I/O by using some of the arguments for input, the rest for output.

Arguments to a FUNCTION

A FUNCTION has a scalar return value passed by value, so a calling C program should expect this. The argument list is passed by reference (i.e., pointers) as in the SUBROUTINE.

If the result of a calculation is an array, then you should use a subroutine, as a FUNCTION cannot return an array.

Interfacing to COMMON Blocks

While there are several ways for Fortran COMMON blocks to be visible to C code, it is often recommended to use an input/output argument list to a SUBROUTINE or FUNCTION. If the Fortran code has already been written and uses COMMON blocks, it is a simple matter to write a small SUBROUTINE that has an input/output argument list and copies data into and out of the COMMON block.

The procedure for copying in and out of the `COMMON` block begins with a write of the inputs to the `COMMON` block before calling the existing `SUBROUTINE`. The `SUBROUTINE` is called, then the output values are read out of the `COMMON` block and copied into the output variables just before returning.

Example C MEX S-Function Calling Fortran Code

The S-function example `sfcndemo_atmos` contains an example of a C MEX S-function calling a Fortran subroutine. The Fortran subroutine `Atmos` is in the file `sfun_atmos_sub.F`. This subroutine calculates the standard atmosphere up to 86 kilometers. The subroutine has four arguments.

```
SUBROUTINE Atmos(alt, sigma, delta, theta)
```

The gateway C MEX S-function, `sfun_atmos.c`, declares the Fortran subroutine.

```
/*
 * Windows uses upper case for Fortran external symbols
 */
#ifdef _WIN32
#define atmos_ ATMOS
#endif

extern void atmos_(float *alt,
                  float *sigma,
                  float *delta,
                  float *theta);
```

The `mdlOutputs` method calls the Fortran subroutine using pass-by-reference for the arguments.

```
/* call the Fortran routine using pass-by-reference */
atmos_(&falt, &fsigma, &fdelta, &ftheta);
```

To see this example working in the sample model `sfcndemo_atmos`, enter the following command at the MATLAB command prompt.

```
sfcndemo_atmos
```

Building Gateway C MEX S-Functions on a Windows System

On 64-bit Windows systems using Intel C++ 12.0 and Intel Visual Fortran 12, you need to use separate commands to compile the Fortran file and then link it to the C gateway file. Each command is on one line.

- 1 Run `cd(matlabroot)` to go to your MATLAB root.
- 2 Run `mex -setup` and select a Fortran compiler.
- 3 Compile the Fortran file using the following command. Enter the command on one line.

```
mex -v -c toolbox\simulink\simdemos\simfeatures\srcFortran\sfun_atmos_sub.o
-f bin\win64\mexopts\intelf12msvs2008opts.bat
```

- 4 Rerun `mex -setup` and select a C compiler.
- 5 Link the compiled Fortran subroutine to the gateway C MEX S-function using the following command. The variable `IFORT_COMPILER12` is the name of the system's environment variable pointing to the Visual Fortran 12 root folder and may vary on your system.

```
!mex -v -L"%IFORT_COMPILER12%\IA64\LIB" -llibifcoremd -lifconsol -lifport
toolbox\simulink\simdemos\simfeatures\srcFortran\sfun_atmos.c sfun_atmos_sub.o
mex -v -c toolbox\simulink\simdemos\simfeatures\srcFortran\sfun_atmos_sub.o
-f bin\win64\mexopts\intelf12msvs2008opts.bat
```

Building Gateway C MEX S-Functions on a UNIX System

Build the gateway on a UNIX system using the command

```
mex sfun_atmos.c sfun_atmos_sub.o
```

On some UNIX systems where the C and Fortran compilers were installed separately (or are not aware of each other), you might need to reference the library `libf2c.a`. To do this, use the `-lf2c` flag.

If the `libf2c.a` library is not on the library path, you need to add the path to the `mex` process explicitly with the `-L` command. For example:

```
mex -L/usr/local/lib/ -lf2c sfun_atmos.c sfun_atmos_sub.o
```

Port Legacy Code

In this section...
“Find the States” on page 6-18
“Sample Times” on page 6-19
“Store Data” on page 6-19
“Use Flints if Needed” on page 6-19
“Considerations for Real Time” on page 6-20

Find the States

If a variable-step solver is being used, it is critical that all continuous states are identified in the code and put into the C S-function state vector for integration instead of being integrated by the Fortran code. Likewise, all derivative calculations must be made available separately to be called from the `mdlDerivatives` method in the C S-function. Without these steps, any Fortran code with continuous states will not be compatible with variable-step solvers if the S-function is registered as a continuous block with continuous states.

Telltale signs of implicit advancement are incremented variables such as $M=M+1$ or $X=X+0.05$. If the code has many of these constructs and you determine that it is impractical to recode the source so as not to “ratchet forward,” you might need to try another approach using fixed-step solvers.

If it is impractical to find all the implicit states and to separate out the derivative calculations for the Simulink engine, another approach can be used, but you are limited to using fixed-step solvers. The technique here is to call the Fortran code from the `mdlUpdate` method so the Fortran code is only executed once per major simulation integration step. Any block outputs must be cached in a work vector so that `mdlOutputs` can be called as often as needed and output the values from the work vector instead of calling the Fortran routine again (causing it to inadvertently advance time). See `sfuntmpl_gate_fortran.c` for an example that uses DWork vectors. See “How to Use DWork Vectors” on page 7-7 for details on allocating data-typed work vectors.

Sample Times

If the Fortran code has an implicit step size in its algorithm, coefficients, etc., ensure that you register the proper discrete sample time in the C S-function `mdlInitializeSampleTimes` method and only change the block's output values from the `mdlUpdate` method.

Store Data

If you plan to have multiple copies of this S-function used in one Simulink model, you need to allocate storage for each copy of the S-function in the model. The recommended approach is to use DWork vectors (see “DWork Vector Basics” on page 7-2).

If you plan to have only one copy of the S-function in the model, DWork vectors still provide the most advanced method for storing data. However, another alternative is to allocate a block of memory using the `malloc` command and store the pointer to that memory in a PWork vector (see “Elementary Work Vectors” on page 7-26). In this case, you must remember to deallocate the memory using the `free` command in the S-function `mdlTerminate` method.

Use Flints if Needed

Use flints (floating-point ints) to keep track of time. Flints (for IEEE-754 floating-point numerics) have the useful property of not accumulating roundoff error when adding and subtracting flints. Using flint variables in `DOUBLE PRECISION` storage (with integer values) avoids roundoff error accumulation that would accumulate when floating-point numbers are added together thousands of times.

```
DOUBLE PRECISION F
      :
      :
F = F + 1.0
TIME = 0.003 * F
```

This technique avoids a common pitfall in simulations.

Considerations for Real Time

Since very few Fortran applications are used in a real-time environment, it is common to come across simulation code that is incompatible with a real-time environment. Common failures include unbounded (or large) iterations and sporadic but time-intensive side calculations. You must deal with these directly if you expect to run in real time.

Conversely, it is still perfectly good practice to have iterative or sporadic calculations if the generated code is not being used for a real-time application.

Using Work Vectors

- “DWork Vector Basics” on page 7-2
- “Types of DWork Vectors” on page 7-5
- “How to Use DWork Vectors” on page 7-7
- “DWork Vector Examples” on page 7-15
- “Elementary Work Vectors” on page 7-26

DWork Vector Basics

In this section...
“What is a DWork Vector?” on page 7-2
“Advantages of DWork Vectors” on page 7-2
“DWork Vectors and the Simulink Engine” on page 7-3
“DWork Vectors and the Simulink® Coder™ Product” on page 7-4

What is a DWork Vector?

DWork vectors are blocks of memory that an S-function asks the Simulink engine to allocate to each instance of the S-function in a model. If multiple instances of your S-function can occur in a model, your S-function must use DWork vectors instead of global or static memory to store instance-specific values of S-function variables. Otherwise, your S-function runs the risk of one instance overwriting data needed by another instance, causing a simulation to fail or produce incorrect results. The ability to keep track of multiple instances of an S-function is called *reentrancy*.

You can create an S-function that is reentrant by using DWork vectors that the engine manages for each particular instance of the S-function.

Advantages of DWork Vectors

DWork vectors have several advantages:

- Provide instance-specific storage for block variables
- Support floating-point, integer, pointer, and general data types
- Eliminate static and global variables
- Interact directly with the Simulink engine to perform memory allocation, initialization, and deallocation
- Facilitate inlining the S-function during code generation
- Provide more control over how data appears in the generated code

Note DWork vectors are the most generalized and versatile type of work vector and the following sections focus on their use. The Simulink product provides additional elementary types of work vectors that support floating-point, integer, pointer, and mode data. You can find a discussion of these work vectors in “Elementary Work Vectors” on page 7-26.

DWork vectors provide the most flexibility for setting data types, names, etc., of the data in the simulation and during code generation. The following list describes all the properties that you can set on a DWork vector:

- Data type
- Size
- Numeric type, either real or complex
- Name
- Usage type (see “Types of DWork Vectors” on page 7-5)
- Simulink Coder identifier
- Simulink Coder storage class
- Simulink Coder C type qualifier

See “How to Use DWork Vectors” on page 7-7 for instructions on how to set these properties. The three Simulink Coder properties pertain only to code generation and have no effect during simulation.

DWork Vectors and the Simulink Engine

A key advantage of DWork vectors is their connection to the Simulink engine. Over the course of the simulation, the engine relieves the S-function of all memory management tasks related to DWork vectors.

To see how this connection is useful, consider an S-function that uses a global variable to store data. If more than one copy of the S-function exists in a model, each instance of the S-function must carefully allocate, manipulate, and deallocate each piece of memory it uses.

In an S-function that uses DWork vectors, the engine, not the S-function, manages the memory for the DWork vector. At the start of a simulation, the engine allocates the memory required for each instance of the S-function based on the size and the data type of the DWork vector contents. At the end of the simulation, the engine automatically deallocates the memory.

Note You have no control over how the engine allocates memory for DWork vectors during simulation. When using the Simulink Coder software, you can use storage classes to customize the memory allocation during code generation. See the `ssSetDWorkRTWStorageClass` reference page for more information on using storage classes.

The engine also performs special tasks based on the type of DWork vector used in the S-function. For example, it includes DWork vectors that store discrete state information in the model-wide state vector and makes them available during state logging.

DWork Vectors and the Simulink Coder Product

DWork vectors allow you to customize how data appears in the generated code. When code is generated, the Simulink Coder code generator includes the DWork vector in the data structure for the model. The DWork vector controls the field name used in the structure. DWork vectors also control the storage class and C type qualifier used in the generated code. See `sfun_rtdwork.c` for an example.

Types of DWork Vectors

All DWork vectors are S-function memory that the Simulink engine manages. The Simulink software supports four types of DWork vectors:

- **General DWork vectors** contain information of any data type.
- **DState vectors** contain discrete state information. Information stored in a DState vector appears as a state in the linearized model and is available during state logging.
- **Scratch vectors** contain values that do not need to persist from one time step to the next.
- **Mode vectors** contain mode information, usually stored as Boolean or integer data.

S-functions register the DWork vector type using the `ssSetDWorkUsageType` macro. This macro accepts one of the four usage types described in the following table.

DWork	Usage Type	Functionality
General	SS_DWORK_USED_AS_DWORK	Store instance specific persistent data. General DWork vectors can also be used to store discrete state and mode data, however the Simulink engine will not treat this information specially. You might choose to use a general DWork vector to store state information if you want to avoid data logging.
DState	SS_DWORK_USED_AS_DSTATE	Store discrete state information. Using the DState vector instead of <code>ssSetNumDiscStates</code> to store discrete states provides more flexibility for naming and data typing the states. The engine marks blocks with discrete states as special during sample time propagation. In addition, the engine makes the data stored in the DState vector available during data logging.

DWork	Usage Type	Functionality
Mode	SS_DWORK_USED_AS_MODE	Indicate to the Simulink engine that the S-function contains modes. The engine handles blocks with modes specially when solving algebraic loops. In addition, the engine updates an S-function with modes only at major time steps. DWork mode vectors are more efficient than standard mode work vectors (see “Elementary Work Vectors” on page 7-26) because they can store mode information as Boolean data. In addition, while an S-function has only one mode work vectors, it can have multiple DWork vectors configured to store modes.
Scratch	SS_DWORK_USED_AS_SCRATCH	Store memory that is not persistent, for example, a large variable that you do not want to mark on the stack. Scratch vectors are scoped to a particular S-function method (for example, mdlOutputs) and exist across a single time step. Scratch memory can be shared across S-function blocks. The Simulink engine attempts to minimize the amount of memory used by scratch variables and reuses scratch memory whenever possible.

How to Use DWork Vectors

In this section...

“Using DWork Vectors in C MEX S-Functions” on page 7-7

“DWork Vector C MEX Macros” on page 7-10

“Using DWork Vectors in Level-2 MATLAB S-Functions” on page 7-12

“Using DWork Vectors With Legacy Code” on page 7-14

Using DWork Vectors in C MEX S-Functions

The following steps show how to initialize and use DWork vectors in a C MEX S-function. For a full list of `SimStruct` macros pertaining to DWork vectors, see “DWork Vector C MEX Macros” on page 7-10.

- 1 In `mdlInitializeSizes`, specify the number of DWork vectors using the `ssSetNumDWork` macro. For example, to specify that the S-function contains two DWork vectors, use the command

```
ssSetNumDWork(S, 2);
```

Although the `mdlInitializeSizes` method tells the Simulink engine how many DWork vectors the S-function will use, the engine does not allocate memory for the DWork vectors, at this time.

An S-function can defer specifying the number of DWork vectors until all information about the S-function inputs is available by passing the value `DYNAMICALLY_SIZED` to the `ssSetNumDWork` macro. If an S-function defers specifying the number of DWork vectors in `mdlInitializeSizes`, it must provide a `mdlSetWorkWidths` method to set up the DWork vectors.

- 2 If the S-function does not provide an `mdlSetWorkWidths` method, the `mdlInitializeSizes` method sets any applicable attributes for each DWork vector. For example, the following lines initialize the widths and data types of the DWork vectors initialized in the previous step.

```
ssSetDWorkWidth(S, 0, 2);  
ssSetDWorkWidth(S, 1, 1);
```

```
ssSetDWorkDataType(S, 0, SS_DOUBLE);
ssSetDWorkDataType(S, 1, SS_BOOLEAN);
```

The following table lists attributes you can set for a DWork vector and shows an example of the macro that sets it. See `ssSetDWorkRTWStorageClass` for a list of supported storage classes.

Attribute	Macro
Data type	<code>ssSetDWorkDataType(S, 0, SS_DOUBLE);</code>
Size	<code>ssSetDWorkWidth(S, 0, 2);</code>
Name	<code>ssSetDWorkName(S, 0, "sfcnState");</code>
Usage type	<code>ssSetDWorkUsageType(S, 0, SS_DWORK_USED_AS_DSTATE);</code>
Numeric type, either real or complex	<code>ssSetDWorkComplexSignal(S, 0, COMPLEX_NO);</code>
Simulink Coder identifier	<code>ssSetDWorkRTWIdentifier(S, 0, "Gain");</code>
Simulink Coder storage class	<code>ssSetDWorkRTWStorageClass(S, 0, 2);</code>
Simulink Coder C type qualifier	<code>ssSetDWorkRTWTypeQualifier(S, 0, "volatile");</code>

- 3** In `mdlStart`, initialize the values of any DWork vectors that should be set only at the beginning of the simulation. Use the `ssGetDWork` macro to retrieve a pointer to each DWork vector and initialize the values. For example, the following `mdlStart` method initializes the first DWork vector.

```
static void mdlStart(SimStruct *S)
{
    real_T *x = (real_T*) ssGetDWork(S,0);

    /* Initialize the first DWork vector */
    x[0] = 0;
    x[1] = 2;
}
```

The Simulink engine allocates memory for the DWork vector before calling the `mdlStart` method. Because the `mdlStart` method is called only once at

the beginning of the simulation, do not use it for data or states that need to be reinitialized, for example, when reenabling a disabled subsystem containing the S-function.

- 4 In `mdlInitializeConditions`, initialize the values of any DWork vectors that need to be reinitialized at certain points in the simulation. The engine executes `mdlInitializeConditions` at the beginning of the simulation and any time an enabled subsystem containing the S-function is reenabled. See the `mdlStart` example in the previous step for the commands used to initialize DWork vector values.
- 5 In `mdlOutputs`, `mdlUpdate`, etc., use the `ssGetDWork` macro to retrieve a pointer to the DWork vector and use or update the DWork vector values. For example, for a DWork vector storing two discrete states, the following `mdlOutputs` and `mdlUpdate` methods calculate the output and update the discrete state values.

The S-function previously defined `U(element)` as `(*uPtrs[element])`, `A`, `B`, `C`, and `D` as the state-space matrices for a discrete state-space system.

```

/* Function: mdlOutputs =====
 * Abstract:
 *      y = Cx + Du
 */
static void mdlOutputs(SimStruct *S, int_T tid)
{
    if( ssGetDWorkUsageType(S, 0) == SS_DWORK_USED_AS_DSTATE) {
        real_T      *y      = ssGetOutputPortRealSignal(S,0);
        real_T      *x      = (real_T*) ssGetDWork(S, 0);
        InputRealPtrsType uPtrs = ssGetInputPortRealSignalPtrs(S,0);

        UNUSED_ARG(tid); /* not used in single tasking mode */

        /* y=Cx+Du */
        y[0]=C[0][0]*x[0]+C[0][1]*x[1]+D[0][0]*U(0)+D[0][1]*U(1);
        y[1]=C[1][0]*x[0]+C[1][1]*x[1]+D[1][0]*U(0)+D[1][1]*U(1);
    }
}

```

```

#define MDL_UPDATE
/* Function: mdlUpdate =====
 * Abstract:
 *      xdot = Ax + Bu
 */
static void mdlUpdate(SimStruct *S, int_T tid)
{
    real_T          tempX[2] = {0.0, 0.0};
    real_T          *x       = (real_T*) ssGetDWork(S, 0);
    InputRealPtrsType uPtrs  = ssGetInputPortRealSignalPtrs(S,0);

    UNUSED_ARG(tid); /* not used in single tasking mode */

    /* xdot=Ax+Bu */
    tempX[0]=A[0][0]*x[0]+A[0][1]*x[1]+B[0][0]*U(0)+B[0][1]*U(1);
    tempX[1]=A[1][0]*x[0]+A[1][1]*x[1]+B[1][0]*U(0)+B[1][1]*U(1);

    x[0]=tempX[0];
    x[1]=tempX[1];
}

```

You do not have to include any code in the `mdlTerminate` method to deallocate the memory used to store the `DWork` vector. Similarly, if you are generating inlined code for the S-function, you do not have to write an `mdlRTW` method to access the `DWork` vector in the TLC file. The Simulink software handles these aspects of the `DWork` vector for you.

DWork Vector C MEX Macros

The following table lists the C MEX macros pertaining to `DWork` vectors.

Macro	Description
<code>ssSetNumDWork</code>	Specify the number of <code>DWork</code> vectors.
<code>ssGetNumDWork</code>	Query the number of <code>DWork</code> vectors.
<code>ssGetDWork</code>	Get a pointer to a specific <code>DWork</code> vector.

Macro	Description
<code>ssGetDWorkComplexSignal</code>	Determine if a specific DWork vector is real or complex.
<code>ssGetDWorkDataType</code>	Get the data type of a DWork vector.
<code>ssGetDWorkName</code>	Get the name of a DWork vector.
<code>ssGetDWorkRTWIdentifier</code>	Get the identifier used to declare a DWork vector in the generated code.
<code>ssGetDWorkRTWIdentifierMustResolveToSignalObject</code>	Indicate if a DWork vector must resolve to a <code>Simulink.Signal</code> object in the MATLAB workspace.
<code>ssGetDWorkRTWStorageClass</code>	Get the storage class of a DWork vector.
<code>ssGetDWorkRTWTypeQualifier</code>	Get the C type qualifier used to declare a DWork vector in the generated code.
<code>ssGetDWorkUsageType</code>	Determine how a DWork vector is used in the S-function.
<code>ssGetDWorkUsedAsDState</code>	Determine if a DWork vector stores discrete states.
<code>ssGetDWorkWidth</code>	Get the size of a DWork vector.
<code>ssSetDWorkComplexSignal</code>	Specify if the elements of a DWork vector are real or complex.
<code>ssSetDWorkDataType</code>	Specify the data type of a DWork vector.
<code>ssSetDWorkName</code>	Specify the name of a DWork vector.
<code>ssSetDWorkRTWIdentifier</code>	Specify the identifier used to declare a DWork vector in the generated code.

Macro	Description
<code>ssSetDWorkRTWIdentifierMustResolveToSignalObject</code>	Specify if a DWork vector must resolve to a <code>Simulink.Signal</code> object.
<code>ssSetDWorkRTWStorageClass</code>	Specify the storage class for a DWork vector.
<code>ssSetDWorkRTWTypeQualifier</code>	Specify the C type qualifier used to declare a DWork vector in the generated code.
<code>ssSetDWorkUsageType</code>	Specify how a DWork vector is used in the S-function.
<code>ssSetDWorkUsedAsDState</code>	Specify that a DWork vector stores discrete state values.
<code>ssSetDWorkWidth</code>	Specify the width of a DWork vector.

Using DWork Vectors in Level-2 MATLAB S-Functions

The following steps show how to initialize and use DWork vectors in Level-2 MATLAB S-functions. These steps use the S-function `msfcn_unit_delay.m`.

- 1 In the `PostPropagationSetup` method, initialize the number of DWork vectors and the attributes of each vector. For example, the following `PostPropagationSetup` callback method configures one DWork vector used to store a discrete state.

```
function PostPropagationSetup(block)

    %% Setup Dwork
    block.NumDworks           = 1;
    block.Dwork(1).Name       = 'x0';
    block.Dwork(1).Dimensions = 1;
    block.Dwork(1).DatatypeID = 0;
    block.Dwork(1).Complexity = 'Real';
    block.Dwork(1).UsedAsDiscState = true;
```

The reference pages for `Simulink.BlockCompDworkData` and the parent class `Simulink.BlockData` list the properties you can set for Level-2 MATLAB S-function DWork vectors.

- 2** Initialize the DWork vector values in either the `Start` or `InitializeConditions` methods. Use the `Start` method for values that are initialized only at the beginning of the simulation. Use the `InitializeConditions` method for values that need to be reinitialized whenever a disabled subsystem containing the S-function is reenabled.

For example, the following `InitializeConditions` method initializes the value of the DWork vector configured in the previous step to the value of the first S-function dialog parameter.

```
function InitializeConditions(block)

    %% Initialize Dwork
    block.Dwork(1).Data = block.DialogPrm(1).Data;
```

- 3** In the `Outputs`, `Update`, etc. methods, use or update the DWork vector values, as needed. For example, the following `Outputs` method sets the S-function output equal to the value stored in the DWork vector. The `Update` method then changes the DWork vector value to the current value of the first S-function input port.

```
%% Outputs callback method
function Outputs(block)

    block.OutputPort(1).Data = block.Dwork(1).Data;

%% Update callback method
function Update(block)

    block.Dwork(1).Data = block.InputPort(1).Data;
```

Note Level-2 MATLAB S-functions do not support MATLAB sparse matrices. Therefore, you cannot assign a sparse matrix to the value of a DWork vector. For example, the following line of code produces an error

```
block.Dwork(1).Data = speye(10);
```

where the `speye` command produces a sparse identity matrix.

Using DWork Vectors With Legacy Code

You can use DWork vectors to communicate with legacy code. If you have existing code that allocates data structures in memory, store a pointer to those data structures in a DWork vector. Your S-function can then communicate with the legacy code via the pointer. Alternatively, for simplicity in setting up your S-function, you can use a pointer work vector to store the pointer. See “Elementary Work Vectors” on page 7-26 for a description of pointer work vectors.

You can also use DWork vectors to store the state of legacy code. The template file `sfuntmpl_gate_fortran.c` shows how to use DWork vectors to interact with legacy Fortran code. The Legacy Code Tool uses DWork vectors to maintain the states of legacy C or C++ code incorporated through the tool. See “Integrate C Functions Using Legacy Code Tool” on page 4-55 for more information on the Legacy Code Tool.

DWork Vector Examples

In this section...

“General DWork Vector” on page 7-15

“DWork Scratch Vector” on page 7-17

“DState Work Vector” on page 7-19

“DWork Mode Vector” on page 7-21

“Level-2 MATLAB S-Function DWork Vector” on page 7-24

General DWork Vector

The S-function `sfun_rtdwork.c` shows how to configure a DWork vector for use with the Simulink Coder product. The Simulink model `sfcdemo_sfundwork` uses this S-function to implement a simple accumulator.

The following portion of the `mdlInitializeSizes` method initializes the DWork vector and all code generation properties associated with it.

```
ssSetNumDWork(S, 1);
ssSetDWorkWidth(S, 0, 1);
ssSetDWorkDataType(S, 0, SS_DOUBLE);

/* Identifier; free any old setting and update */
id = ssGetDWorkRTWIdentifier(S, 0);
if (id != NULL) {
    free(id);
}
id = malloc(80);
mxGetString(ID_PARAM(S), id, 80);
ssSetDWorkRTWIdentifier(S, 0, id);

/* Type Qualifier; free any old setting and update */
tq = ssGetDWorkRTWTypeQualifier(S, 0);
if (tq != NULL) {
    free(tq);
}
```

```
tq = malloc(80);
mxGetString(TQ_PARAM(S), tq, 80);
ssSetDWorkRTWTypeQualifier(S, 0, tq);

/* Storage class */
sc = ((int_T) *((real_T*) mxGetPr(SC_PARAM(S)))) - 1;
ssSetDWorkRTWStorageClass(S, 0, sc);
```

The S-function initializes the DWork vector in `mdlInitializeConditions`.

```
#define MDL_INITIALIZE_CONDITIONS
/* Function: mdlInitializeConditions =====
 * Abstract:
 *   Initialize both continuous states to zero
 */
static void mdlInitializeConditions(SimStruct *S)
{
    real_T *x = (real_T*) ssGetDWork(S,0);

    /* Initialize the dwork to 0 */
    x[0] = 0.0;
}
```

The `mdlOutputs` method assigns the DWork vector value to the S-function output.

```
/* Function: mdlOutputs =====
 * Abstract:
 *   y = x
 */
static void mdlOutputs(SimStruct *S, int_T tid)
{
    real_T *y = ssGetOutputPortRealSignal(S,0);
    real_T *x = (real_T*) ssGetDWork(S,0);

    /* Return the current state as the output */
    y[0] = x[0];
}
```

The `mdlUpdate` method increments the DWork value by the input.

```

#define MDL_UPDATE
/* Function: mdlUpdate =====
 * Abstract:
 *   This function is called once for every major integration
 *   time step. Discrete states are typically updated here, but
 *   this function is useful for performing any tasks that should
 *   only take place once per integration step.
 */
static void mdlUpdate(SimStruct *S, int_T tid)
{
    real_T *x = (real_T*) ssGetDWork(S,0);
    InputRealPtrsType uPtrs = ssGetInputPortRealSignalPtrs(S,0);

    /*
     * Increment the state by the input
     * U is defined as U(element) (*uPtrs[element])
     */
    x[0] += U(0);
}

```

DWork Scratch Vector

The following example uses a scratch DWork vector to store a static variable value. The `mdlInitializeSizes` method configures the width and data type of the DWork vector. The `ssSetDWorkUsageType` macro then specifies the DWork vector is a scratch vector.

```

ssSetNumDWork(S, 1);

ssSetDWorkWidth(S, 0, 1);
ssSetDWorkDataType(S, 0, SS_DOUBLE);
ssSetDWorkUsageType(S,0, SS_DWORK_USED_AS_SCRATCH);

```

The remainder of the S-function uses the scratch DWork vector exactly as it would any other type of DWork vector. The `InitializeConditions` method sets the initial value and the `mdlOutputs` method uses the value stored in the DWork vector.

```

#define MDL_INITIALIZE_CONDITIONS
/* Function: mdlInitializeConditions ===== */
static void mdlInitializeConditions(SimStruct *S)

```

```

{
    real_T *x = (real_T*) ssGetDWork(S,0);
    /* Initialize the dwork to 0 */
    x[0] = 0.0;
}
/* Function: mdlOutputs ===== */
static void mdlOutputs(SimStruct *S, int_T tid)
{
    real_T *y = ssGetOutputPortRealSignal(S,0);
    real_T *x1 = (real_T*) ssGetDWork(S,1);

    x[0] = 2000;
    y[0] = x[0] * 2;
}

```

If you have Simulink Coder, the Simulink Coder software handles scratch DWork differently from other DWork vectors when generating code for inlined S-function. To inline the S-function, create the following Target Language Compiler (TLC) file to describe the mdlOutputs method.

```

%implements sfun_dscratch "C"

%% Function: Outputs =====
%%
/* dscratch Block: %<Name> */
%<LibBlockDWork(DWork[0], "", "", 0)> = 2000.0;
%<LibBlockOutputSignal(0, "", "", 0)> = %<LibBlockDWork(DWork[0], "", "", 0)> * 2;

```

When the Simulink Coder software generates code for the model, it inlines the S-function and declares the second DWork vector as a local scratch vector. For example, the model outputs function contains the following lines:

```

/* local scratch DWork variables */
real_T SFunction_DWORK1;
SFunction_DWORK1 = 2000.0;

```

If the S-function used a general DWork vector instead of a scratch DWork vector, generating code with the same TLC file would have resulted in the DWork vector being included in the data structure, as follows:

```

sfcn demo_dscratch_DWork.SFunction_DWORK1 = 2000.0;

```

DState Work Vector

This example rewrites the S-function example `dsfunc.c` to use a DState vector instead of an explicit discrete state vector. The `mdlInitializeSizes` macro initializes the number of discrete states as zero and, instead, initializes one DWork vector.

The `mdlInitializeSizes` method then configures the DWork vector as a DState vector using a call to `ssSetDWorkUsedAsDState`. This is equivalent to calling the `ssSetDWorkUsageType` macro with the value `SS_DWORK_USED_AS_DSTATE`. The `mdlInitializeSizes` method sets the width and data type of the DState vector and gives the state a name using `ssSetDWorkName`.

Note DWork vectors configured as DState vectors must be assigned a name for the Simulink engine to register the vector as discrete states. The function `Simulink.BlockDiagram.getInitialStates(mdl)` returns the assigned name in the `label` field for the initial states.

```
static void mdlInitializeSizes(SimStruct *S)
{
    ssSetNumSFcnParams(S, 0); /* Number of expected parameters */
    if (ssGetNumSFcnParams(S) != ssGetSFcnParamsCount(S)) {
        return; /* Parameter mismatch reported by the Simulink engine */
    }

    ssSetNumContStates(S, 0);
    ssSetNumDiscStates(S, 0);

    if (!ssSetNumInputPorts(S, 1)) return;
    ssSetInputPortWidth(S, 0, 2);
    ssSetInputPortDirectFeedThrough(S, 0, 1);

    if (!ssSetNumOutputPorts(S, 1)) return;
    ssSetOutputPortWidth(S, 0, 2);

    ssSetNumSampleTimes(S, 1);
    ssSetNumRWork(S, 0);
    ssSetNumIWork(S, 0);
}
```

```

        ssSetNumPWork(S, 0);
        ssSetNumModes(S, 0);
        ssSetNumNonsampledZCs(S, 0);

        ssSetNumDWork(S, 1);
        ssSetDWorkUsedAsDState(S, 0, SS_DWORK_USED_AS_DSTATE);
        ssSetDWorkWidth(S, 0, 2);
        ssSetDWorkDataType(S, 0, SS_DOUBLE);
        ssSetDWorkName(S, 0, "SfunStates");

        ssSetOptions(S, SS_OPTION_EXCEPTION_FREE_CODE);
    }

```

The `mdlInitializeConditions` method initializes the `DState` vector values using the pointer returned by `ssGetDWork`.

```

#define MDL_INITIALIZE_CONDITIONS
/* Function: mdlInitializeConditions =====
 * Abstract:
 *   Initialize both discrete states to one.
 */
static void mdlInitializeConditions(SimStruct *S)
{
    real_T *x0 = (real_T*) ssGetDWork(S, 0);
    int_T lp;

    for (lp=0;lp<2;lp++) {
        *x0+=1.0;
    }
}

```

The `mdlOutputs` method then uses the values stored in the `DState` vector to compute the output of the discrete state-space equation.

```

/* Function: mdlOutputs =====
 * Abstract:
 *    $y = Cx + Du$ 
 */
static void mdlOutputs(SimStruct *S, int_T tid)
{

```

```

real_T          *y   = ssGetOutputPortRealSignal(S,0);
real_T          *x   = (real_T*) ssGetDWork(S, 0);
InputRealPtrsType uPtrs = ssGetInputPortRealSignalPtrs(S,0);

UNUSED_ARG(tid); /* not used in single tasking mode */

/* y=Cx+Du */
y[0]=C[0][0]*x[0]+C[0][1]*x[1]+D[0][0]*U(0)+D[0][1]*U(1);
y[1]=C[1][0]*x[0]+C[1][1]*x[1]+D[1][0]*U(0)+D[1][1]*U(1);
}

```

Finally, the `mdlUpdate` method updates the `DState` vector with new values for the discrete states.

```

#define MDL_UPDATE
/* Function: mdlUpdate =====
 * Abstract:
 *      xdot = Ax + Bu
 */
static void mdlUpdate(SimStruct *S, int_T tid)
{
    real_T          tempX[2] = {0.0, 0.0};
    real_T          *x       = (real_T*) ssGetDWork(S, 0);
    InputRealPtrsType uPtrs   = ssGetInputPortRealSignalPtrs(S,0);

    UNUSED_ARG(tid); /* not used in single tasking mode */

    /* xdot=Ax+Bu */
    tempX[0]=A[0][0]*x[0]+A[0][1]*x[1]+B[0][0]*U(0)+B[0][1]*U(1);
    tempX[1]=A[1][0]*x[0]+A[1][1]*x[1]+B[1][0]*U(0)+B[1][1]*U(1);

    x[0]=tempX[0];
    x[1]=tempX[1];
}

```

DWork Mode Vector

This example rewrites the S-function `sfun_zc.c` to use a DWork mode vector instead of an explicit mode work vector (see “Elementary Work Vectors” on page 7-26 for more information on mode work vectors). This S-function implements an absolute value block.

The `mdlInitializeSizes` method sets the number of DWork vectors and zero-crossing vectors (see “Zero Crossings” on page 8-50) to `DYNAMICALLY_SIZED`. The `DYNAMICALLY_SIZED` setting allows the Simulink engine to defer specifying the work vector sizes until it knows the dimensions of the input, allowing the S-function to support an input with an arbitrary width.

```
static void mdlInitializeSizes(SimStruct *S)
{
    ssSetNumSFcnParams(S, 0);
    if (ssGetNumSFcnParams(S) != ssGetSFcnParamsCount(S)) {
        return; /* Parameter mismatch reported by the Simulink engine */
    }

    ssSetNumContStates( S, 0);
    ssSetNumDiscStates( S, 0);

    if (!ssSetNumInputPorts(S, 1)) return;
    ssSetInputPortWidth(S, 0, DYNAMICALLY_SIZED);
    ssSetInputPortDirectFeedThrough(S, 0, 1);

    if (!ssSetNumOutputPorts(S,1)) return;
    ssSetOutputPortWidth(S, 0, DYNAMICALLY_SIZED);

    ssSetNumSampleTimes(S, 1);
    ssSetNumRWork(S, 0);
    ssSetNumIWork(S, 0);
    ssSetNumPWork(S, 0);
    ssSetNumDWork(S, 1);
    ssSetNumModes(S, 0);

    /* Initializes the zero-crossing and DWork vectors */
    ssSetDWorkWidth(S,0,DYNAMICALLY_SIZED);
    ssSetNumNonsampledZCs(S, DYNAMICALLY_SIZED);

    /* Take care when specifying exception free code - see sfuntmpl_doc.c */
    ssSetOptions(S, SS_OPTION_EXCEPTION_FREE_CODE);
}
```

The Simulink engine initializes the number of zero-crossing vectors and DWork vectors to the number of elements in the signal coming into the first S-function input port. The engine then calls the `mdlSetWorkWidths` method, which uses `ssGetNumDWork` to determine how many DWork vectors were initialized and then sets the properties for each DWork vector.

```
#define MDL_SET_WORK_WIDTHS
static void mdlSetWorkWidths(SimStruct *S) {
    int_T numdw = ssGetNumDWork(S);
    int_T i;

    for (i = 0; i < numdw; i++) {
        ssSetDWorkUsageType(S, i, SS_DWORK_USED_AS_MODE);
        ssSetDWorkDataType(S, i, SS_BOOLEAN);
        ssSetDWorkComplexSignal(S, i, COMPLEX_NO);
    }
}
```

The `mdlOutputs` method uses the value stored in the DWork mode vector to determine if the output signal should be equal to the input signal or the absolute value of the input signal.

```
static void mdlOutputs(SimStruct *S, int_T tid)
{
    int_T i;
    InputRealPtrsType uPtrs = ssGetInputPortRealSignalPtrs(S,0);
    real_T *y = ssGetOutputPortRealSignal(S,0);
    int_T width = ssGetOutputPortWidth(S,0);
    boolean_T *mode = ssGetDWork(S,0);

    UNUSED_ARG(tid); /* not used in single tasking mode */

    if (ssIsMajorTimeStep(S)) {
        for (i = 0; i < width; i++) {
            mode[i] = (boolean_T)(*uPtrs[i] >= 0.0);
        }
    }

    for (i = 0; i < width; i++) {
        y[i] = mode[i]? (*uPtrs[i]): -(*uPtrs[i]);
    }
}
```

```
    }  
}
```

Level-2 MATLAB S-Function DWork Vector

The example S-function `msfcn_varpulse.m` models a variable width pulse generator. The S-function uses two DWork vectors. The first DWork vector stores the pulse width value, which is modified at every major time step in the `Update` method. The second DWork vector stores the handle of the pulse generator block in the Simulink model. The value of this DWork vector does not change over the course of the simulation.

The `PostPropagationSetup` method, called `DoPostPropSetup` in this S-function, sets up the two DWork vectors.

```
function DoPostPropSetup(block)  
  
% Initialize the Dwork vector  
block.NumDworks = 2;  
  
% Dwork(1) stores the value of the next pulse width  
block.Dwork(1).Name      = 'x1';  
block.Dwork(1).Dimensions = 1;  
block.Dwork(1).DatatypeID = 0;      % double  
block.Dwork(1).Complexity = 'Real'; % real  
block.Dwork(1).UsedAsDiscState = true;  
  
% Dwork(2) stores the handle of the Pulse Generator block  
block.Dwork(2).Name      = 'BlockHandle';  
block.Dwork(2).Dimensions = 1;  
block.Dwork(2).DatatypeID = 0;      % double  
block.Dwork(2).Complexity = 'Real'; % real  
block.Dwork(2).UsedAsDiscState = false;
```

The `Start` method initializes the DWork vector values.

```
function Start(block)  
  
% Populate the Dwork vector  
block.Dwork(1).Data = 0;
```

```
% Obtain the Pulse Generator block handle
pulseGen = find_system(gcs,'BlockType','DiscretePulseGenerator');
blockH = get_param(pulseGen{1},'Handle');
block.Dwork(2).Data = blockH;
```

The `Outputs` method uses the handle stored in the second `DWork` vector to update the pulse width of the Pulse Generator block.

```
function Outputs(block)

% Update the pulse width value
set_param(block.Dwork(2).Data, 'PulseWidth', num2str(block.InputPort(1).data));
```

The `Update` method then modifies the first `DWork` vector with the next value for the pulse width, specified by the input signal to the S-Function block.

```
function Update(block)

% Store the input value in the Dwork(1)
block.Dwork(1).Data = block.InputPort(1).Data;

%endfunction
```

Elementary Work Vectors

In this section...
“Description of Elementary Work Vector” on page 7-26
“Relationship to DWork Vectors” on page 7-26
“Using Elementary Work Vectors” on page 7-27
“Additional Work Vector Macros” on page 7-29
“Elementary Work Vector Examples” on page 7-30

Description of Elementary Work Vector

In addition to DWork vectors, the Simulink software provides a simplified set of work vectors. In some S-functions, these elementary work vectors can provide an easier solution than using DWork vectors:

- **IWork vectors** store integer data.
- **Mode vectors** model zero crossings or other features that require a single mode vector.
- **PWork vectors** store pointers to data structures, such as those that interface the S-function to legacy code, another software application, or a hardware application.
- **RWork vectors** store floating-point (real) data.

Relationship to DWork Vectors

The following table compares each type of work vector to a DWork vector.

Work Vector Type	Comparison to DWork Vector	How to create equivalent DWork vector
IWork	IWork vectors cannot be customized in the generated code. Also, you are allowed only one IWork vector.	<pre>ssSetNumDWork(S,1); ssSetDWorkDataType(S, 0, SS_INT8);</pre>
Mode	Mode vectors require more memory than DWork vectors since the mode vector is always stored with an integer data type. Also, you are allowed only one Mode vector.	<pre>ssSetNumDWork(S,1); ssSetDWorkUsageType(S, 0, SSS_DWORK_USED_AS_MODE); ssSetDWorkDataType(S, 0, SS_INT8);</pre>
PWork	Unlike DWork vectors, PWork vectors cannot be named in the generated code. Also, you are allowed only one PWork vector.	<pre>ssSetNumDWork(S,1); ssSetDWorkDataType(S, 0, SS_POINTER);</pre> <p>The DWork vector then stores a pointer.</p>
RWork	RWork vectors cannot be customized in the generated code. Also, you are allowed only one RWork vector.	<pre>ssSetNumDWork(S,1); ssSetDWorkDataType(S, 0, SS_DOUBLE);</pre>

Using Elementary Work Vectors

The process for using elementary work vectors is similar to that for DWork vectors (see “Using DWork Vectors in C MEX S-Functions” on page 7-7.) The elementary work vectors have fewer properties, so the initialization process is simpler. However, if you need to generate code for the S-function, the S-function becomes more involved than when using DWork vectors.

The following steps show how to set up and use elementary work vectors. See “Additional Work Vector Macros” on page 7-29 for a list of macros related to each step in the following process.

- 1 In `mdlInitializeSizes`, specify the size of the work vectors using the `ssSetNumXWork` macro, for example:

```
ssSetNumPWork(2);
```

This macro indicates how many elements the work vector contains, however, the Simulink engine does not allocate memory, at this time.

An S-function can defer specifying the length of the work vectors until all information about the S-function inputs is available by passing the value `DYNAMICALLY_SIZED` to the `ssSetNumXWork` macro. If an S-function defers specifying the length of the work vectors in `mdlInitializeSizes`, it must provide a `mdlSetWorkWidths` method to set up the work vectors.

Note If an S-function uses `mdlSetWorkWidths`, all work vectors used in the S-function must be set to `DYNAMICALLY_SIZED` in `mdlInitializeSizes`, even if the exact value is known before `mdlInitializeSizes` is called. The sizes to be used by the S-function are than specified in `mdlSetWorkWidths`.

For an example, see `sfun_dynsize.c`.

- 2** In `mdlStart`, assign values to the work vectors that are initialized only at the start of the simulation. Use the `ssGetXWork` macro to retrieve a pointer to each work vector and use the pointer to initialize the work vector values. Alternatively, use the `ssGetXWorkValues` to assign values to particular elements of the work vector.

The Simulink engine calls the `mdlStart` method once at the beginning of the simulation. Before calling this method, the engine allocates memory for the work vectors. Do not use the `mdlStart` method for data that needs to be reinitialized over the course of the simulation, for example, data that needs to be reinitialized when an enabled subsystem containing the S-function is enabled.

- 3** In `mdlInitializeConditions`, initialize the values of any work vectors that might need to be reinitialized at certain points in the simulation. The engine executes `mdlInitializeConditions` at the beginning of the simulation and any time an enabled subsystem containing the S-function is reenabled.
- 4** In `mdlOutputs`, `mdlUpdate`, etc., use the `ssGetXWork` macro to retrieve a pointer to the work vector and use the pointer to access or update the work vector values.

- 5** Write an mdlRTW method to allow the Target Language Compiler (TLC) to access the work vector. This step is not necessary if the S-function uses DWork vectors. For information on writing parameter data in an mdlRTW method, see `ssWriteRTWParamSettings`. For more information on generating code using an mdlRTW method, see “Write Fully Inlined S-Functions with mdlRTW Routine”.

Additional Work Vector Macros

Macro	Description
<code>ssSetNumRWork</code>	Specify the width of the real work vector.
<code>ssGetNumRWork</code>	Query the width of the real work vector.
<code>ssSetNumIWork</code>	Specify the width of the integer work vector.
<code>ssGetNumIWork</code>	Query the width of the integer work vector.
<code>ssSetNumPWork</code>	Specify the width of the pointer work vector.
<code>ssGetNumPWork</code>	Query the width of the pointer work vector.
<code>ssSetNumModes</code>	Specify the width of the mode work vector.
<code>ssGetNumModes</code>	Query the width of the mode work vector.
<code>ssGetIWork</code>	Get a pointer to the integer work vector.
<code>ssGetIWorkValue</code>	Get an element of the integer work vector.
<code>ssGetModeVector</code>	Get a pointer to the mode work vector.
<code>ssGetModeVectorValue</code>	Get an element of the mode work vector.
<code>ssGetPWork</code>	Get a pointer to the pointer work vector.
<code>ssGetPworkValue</code>	Get one element from the pointer work vector.
<code>ssGetRWork</code>	Get a pointer to the floating-point work vector.
<code>ssGetRWorkValue</code>	Get an element of the floating-point work vector.
<code>ssSetIWorkValue</code>	Set the value of one element of the integer work vector.
<code>ssSetModeVectorValue</code>	Set the value of one element of the mode work vector.

Macro	Description
ssSetPWorkValue	Set the value of one element of the pointer work vector.
ssSetRWorkValue	Set the value of one element of the floating-point work vector.

Elementary Work Vector Examples

The following sections provide examples of the four types of elementary work vectors.

Pointer Work Vector

This example opens a file and stores the FILE pointer in the pointer work vector.

The following statement, included in the `mdlInitializeSizes` function, indicates that the pointer work vector is to contain one element.

```
ssSetNumPWork(S, 1) /* pointer-work vector */
```

The following code uses the pointer work vector to store a FILE pointer, returned from the standard I/O function `fopen`.

```
#define MDL_START /* Change to #undef to remove function. */
#if defined(MDL_START)
static void mdlStart(real_T *x0, SimStruct *S)
{
    FILE *fPtr;
    void **PWork = ssGetPWork(S);
    fPtr = fopen("file.data", "r");
    PWork[0] = fPtr;
}
#endif /* MDL_START */
```

The following code retrieves the FILE pointer from the pointer work vector and passes it to `fclose` in order to close the file.

```
static void mdlTerminate(SimStruct *S)
```

```

{
  if (ssGetPWork(S) != NULL) {
    FILE *fPtr;
    fPtr = (FILE *) ssGetPWorkValue(S,0);
    if (fPtr != NULL) {
      fclose(fPtr);
    }
    ssSetPWorkValue(S,0,NULL);
  }
}

```

Note Although the Simulink engine handles deallocating the PWork vector, the mdlTerminate method must always free the memory stored in the PWork vector.

Real and Integer Work Vectors

The S-function stvctf.c uses RWork and IWork vectors to model a time-varying continuous transfer function. For a description of this S-function, see the example “Discontinuities in Continuous States” on page 8-129.

Mode Vector

The following example implements a switch block using a mode work vector. The mdlInitializeSizes method configures two input ports with direct feedthrough and one output port. The mode vector element indicates if the signal from the first or second input port is propagated to the output. The S-function uses one S-function parameter and a corresponding run-time parameter to store the mode value and allow the switch to be toggled during simulation.

```

static void mdlInitializeSizes(SimStruct *S)
{
  /* Initialize one S-function parameter to toggle the mode value */
  ssSetNumSFcnParams(S, 1);
  if (ssGetNumSFcnParams(S) != ssGetSFcnParamsCount(S)) {
    /* Return if number of expected != number of actual parameters */
    return;
  }
}

```

```

{
    int iParam = 0;
    int nParam = ssGetNumSFcnParams(S);

    for ( iParam = 0; iParam < nParam; iParam++ )
    {
        ssSetSFcnParamTunable( S, iParam, SS_PRM_TUNABLE );
    }
}

/* Initialize two input ports with direct feedthrough */
if (!ssSetNumInputPorts(S, 2)) return;
ssSetInputPortWidth(S, 0, 1);
ssSetInputPortWidth(S, 1, 1);
ssSetInputPortDataType( S, 0, SS_DOUBLE);
ssSetInputPortDataType( S, 1, SS_DOUBLE);
ssSetInputPortDirectFeedThrough( S, 0, 1);
ssSetInputPortDirectFeedThrough( S, 1, 1);

/* Initialize one output port */
if (!ssSetNumOutputPorts(S, 1)) return;
ssSetOutputPortWidth(S, 0, 1);
ssSetOutputPortDataType( S, 0, SS_DOUBLE);

/* Initialize one element in the mode vector */
ssSetNumSampleTimes(S, 1);
ssSetNumModes(S,1);

ssSetOptions(S,
             SS_OPTION_WORKS_WITH_CODE_REUSE |
             SS_OPTION_USE_TLC_WITH_ACCELERATOR |
             SS_OPTION_DISALLOW_CONSTANT_SAMPLE_TIME |
             SS_OPTION_NONVOLATILE);
}

```

The `mdlInitializeConditions` method initializes the mode vector value using the current value of the S-function dialog parameter.

```

#define MDL_INITIALIZE_CONDITIONS
/* Function: mdlInitializeConditions =====

```

```

* Abstract:
*   Initialize the mode vector value.
*/
static void mdlInitializeConditions(SimStruct *S)
{
    int_T *mv = ssGetModeVector(S);
    real_T param = mxGetScalar(ssGetSFcnParam(S,0));
    mv[0] = (int_T)param;
}

```

The `mdlProcessParameters` and `mdlSetWorkWidths` methods initialize and update the run-time parameter. As the simulation runs, changes to the S-function dialog parameter are mapped to the run-time parameter.

```

/* Function: mdlSetWorkWidths =====
* Abstract:
*   Sets the number of runtime parameters.
*/
#define MDL_SET_WORK_WIDTHS
static void mdlSetWorkWidths(SimStruct *S) {
    ssSetNumRunTimeParams(S,1);
    ssRegDlgParamAsRunTimeParam(S,0,0,"P1",SS_INT16);
}

/* Function: mdlProcessParameters =====
* Abstract:
*   Update run-time parameters.
*/
#define MDL_PROCESS_PARAMETERS
static void mdlProcessParameters(SimStruct *S)
{
    ssUpdateDlgParamAsRunTimeParam(S,0);
}

```

The `mdlOutputs` method updates the mode vector value with the new run-time parameter value at every major time step. It then uses the mode vector value to determine which input signal to pass through to the output.

```

static void mdlOutputs(SimStruct *S, int_T tid)
{

```

```
InputRealPtrsType uPtrs = ssGetInputPortRealSignalPtrs(S,0);
InputRealPtrsType u2Ptrs = ssGetInputPortRealSignalPtrs(S,1);
real_T      *y = ssGetOutputPortSignal(S,0);
int_T      *mode = ssGetModeVector(S);
real_T      param = mxGetScalar(ssGetSFcnParam(S,0));

if (ssIsMajorTimeStep(S)) {
    mode[0] = (int_T)param;
}

if (!mode[0]) {
    /* first input */
    y[0] = (*uPtrs[0]);
}
if (mode[0]) {
    /* second input */
    y[0] = (*u2Ptrs[0]);
}
}
```

Implementing Block Features

- “Dialog Parameters” on page 8-2
- “Run-Time Parameters” on page 8-8
- “Input and Output Ports” on page 8-18
- “Custom Data Types” on page 8-28
- “Sample Times” on page 8-32
- “Zero Crossings” on page 8-50
- “S-Function Compliance with the `SimState`” on page 8-54
- “Matrices in C S-Functions” on page 8-57
- “Function-Call Subsystems and S-Functions” on page 8-59
- “Sim Viewing Devices in External Mode” on page 8-65
- “Frame-Based Signals” on page 8-66
- “Error Handling” on page 8-69
- “C MEX S-Function Examples” on page 8-73

Dialog Parameters

In this section...
“About Dialog Parameters” on page 8-2
“Tunable Parameters” on page 8-5

About Dialog Parameters

You can pass parameters to an S-function at the start of and during the simulation, using the **S-function parameters** field of the Block Parameters dialog box. Such parameters are called *dialog box parameters* to distinguish them from run-time parameters created by the S-function to facilitate code generation (see “Run-Time Parameters” on page 8-8).

Note You cannot use the Model Explorer, the S-function Block Parameters dialog box, or a mask to tune the parameters of a source S-function, i.e., an S-function that has outputs but no inputs, while a simulation is running. For more information, see “Tunable Parameters”.

Using C S-Function Dialog Parameters

The Simulink engine stores the values of the dialog box parameters in the S-function `SimStruct` structure. Use the S-function callback methods and `SimStruct` macros to access and check the parameters and use them to compute the S-function output. To use dialog parameters in your C S-function, perform the following steps when you create the S-function:

- 1 Determine the order in which the parameters are to be specified in the block’s dialog box.
- 2 In the `mdlInitializeSizes` function, use the `ssSetNumSFcnParams` macro to tell the Simulink engine how many parameters the S-function accepts. Specify `S` as the first argument and the number of dialog box parameters as the second argument. If your S-function implements the `mdlCheckParameters` method, the `mdlInitializeSizes` routine should call `mdlCheckParameters` to check the validity of the initial values of

the parameters. For example, the `mdlInitializeSizes` function in `sfun_runtime1.c` begins with the following code.

```
ssSetNumSFcnParams(S, NPARAMS); /* Number of expected parameters */
#ifdef MATLAB_MEX_FILE
    if (ssGetNumSFcnParams(S) == ssGetSFcnParamsCount(S)) {
        mdlCheckParameters(S);
        if (ssGetErrorStatus(S) != NULL) {
            return;
        }
    } else {
        return; /* Parameter mismatch reported by the Simulink engine*/
    }
#endif
```

3 Access the dialog box parameters in the S-function using the `ssGetSFcnParam` macro.

Specify `S` as the first argument and the relative position of the parameter in the list entered on the dialog box (0 is the first position) as the second argument. The `ssGetSFcnParam` macro returns a pointer to the `mxArray` containing the parameter. You can use `ssGetDTypeIdFromMxArray` to get the data type of the parameter.

For example, in `sfun_runtime1.c`, the following `#define` statements at the beginning of the S-function specify the order of three dialog box parameters and access their values on the block's dialog.

```
#define SIGNS_IDX 0
#define SIGNS_PARAM(S) ssGetSFcnParam(S,SIGNS_IDX) /* First parameter */

#define GAIN_IDX 1
#define GAIN_PARAM(S) ssGetSFcnParam(S,GAIN_IDX) /* Second parameter */

#define OUT_IDX 2
#define OUT_PARAM(S) ssGetSFcnParam(S,OUT_IDX) /* Third parameter */
```

When running a simulation, you must specify the parameters in the **S-Function parameters** field of the S-Function Block Parameters dialog box in the same order that you defined them in step 1. You can enter any valid MATLAB expression as the value of a parameter, including literal

values, names of workspace variables, function invocations, or arithmetic expressions. The Simulink engine evaluates the expression and passes its value to the S-function.

As another example, the following code is part of a device driver S-function. Four input parameters are used: `BASE_ADDRESS_PRM`, `GAIN_RANGE_PRM`, `PROG_GAIN_PRM`, and `NUM_OF_CHANNELS_PRM`. The code uses `#define` statements at the top of the S-function to associate particular input arguments with the parameter names.

```
/* Input Parameters */
#define BASE_ADDRESS_PRM(S)      ssGetSFcnParam(S, 0)
#define GAIN_RANGE_PRM(S)       ssGetSFcnParam(S, 1)
#define PROG_GAIN_PRM(S)        ssGetSFcnParam(S, 2)
#define NUM_OF_CHANNELS_PRM(S)  ssGetSFcnParam(S, 3)
```

When running the simulation, enter four variable names or values in the **S-function parameters** field of the S-Function Block Parameters dialog box. The first corresponds to the first expected parameter, `BASE_ADDRESS_PRM(S)`. The second corresponds to the next expected parameter, and so on.

The `mdlInitializeSizes` function contains this statement.

```
ssSetNumSFcnParams(S, 4);
```

Using Level-2 MATLAB S-Function Dialog Parameters

The Simulink engine stores Level-2 MATLAB S-function dialog parameters in the block run-time object. To use dialog parameters in a Level-2 MATLAB S-function, perform the following steps when you create the S-function:

- 1 Determine the order in which the parameters are to be specified in the block's dialog box.
- 2 In the setup method, set the run-time object's `NumDialogPrms` property to indicate to the engine how many parameters the S-function accepts, for example:

```
block.NumDialogPrms = 2;
```

- 3 Access the dialog box parameters in the S-function using the run-time object's `DialogPrm` method. The dialog parameter's `Data` property stores its current value, for example:

```
param1 = block.DialogPrm(1).Data;  
param2 = block.DialogPrm(2).Data;
```

When running a simulation, you must specify the parameters in the **Parameters** field of the Level-2 MATLAB S-Function Block Parameters dialog box in the same order that you defined them in step 1.

Tunable Parameters

Dialog parameters can be either tunable or nontunable. A tunable parameter is a parameter that a user can change while the simulation is running.

Note Dialog box parameters are tunable by default. Nevertheless, it is good programming practice to set the tunability of every parameter, even those that are tunable. If you enable the simulation diagnostic **S-function upgrades needed**, the Simulink engine issues the diagnostic whenever it encounters an S-function that fails to specify the tunability of all its parameters.

The `mdlCheckParameters` method enables you to validate changes to tunable parameters during a simulation. The engine invokes the `mdlCheckParameters` method whenever you change the values of parameters during the simulation loop. This method should check the S-function dialog box parameters to ensure that the changes are valid.

The optional `mdlProcessParameters` callback method allows an S-function to process changes to tunable parameters. The engine invokes this method only if valid parameter changes have occurred in the previous time step. A typical use of this method is to perform computations that depend only on the values of parameters and hence need to be computed only when parameter values change. The method can cache the results of the parameter computations in work vectors or, preferably, as run-time parameters (see “Run-Time Parameters” on page 8-8).

Using Tunable Parameters in a C S-Function

In a C S-function, use the macro `ssSetSFcnParamTunable` in `mdlInitializeSizes` to specify the tunability of each S-function dialog box parameter. The code below is taken from the `mdlInitializeSizes` function in the example `sfun_runtime1.c`. The code first sets the number of S-function dialog box parameters to three before invoking `mdlCheckParameters`. If the parameter check passes, the tunability of the three S-function dialog box parameters is specified.

```
ssSetNumSFcnParams(S, 3); /* Three dialog box parameters*/

#if defined(MATLAB_MEX_FILE)
    if (ssGetNumSFcnParams(S) == ssGetSFcnParamsCount(S)) {
        mdlCheckParameters(S);
        if (ssGetErrorStatus(S) != NULL) {
            return;
        }
    } else {
        return; /* Parameter mismatch reported by the Simulink engine*/
    }
#endif

ssSetSFcnParamTunable(S,GAIN_IDX,true); /* Tunable */
ssSetSFcnParamTunable(S,SIGNS_IDX,false); /* Not tunable */
ssSetSFcnParamTunable(S,OUT_IDX,false); /* Not tunable */
```

Note The S-function `mdlInitializeSizes` routine invokes the `mdlCheckParameters` method to ensure that the initial values of the parameters are valid.

Using Tunable Parameters in a Level-2 MATLAB S-Function

In a Level-2 MATLAB S-function, set the run-time object `DialogPrmsTunable` property in the `setup` method to specify the tunability of each S-function dialog box parameter. For example, the following line sets the first parameter of an S-function with three dialog parameters to tunable, and the second and third parameters to nontunable.

```
block.DialogPrmsTunable = {'Tunable','Nontunable','Nontunable'};
```

Tuning Parameters in External Mode

When you tune parameters during simulation, the Simulink engine invokes the S-function `mdlCheckParameters` method to validate the changes and then the S-functions' `mdlProcessParameters` method to give the S-function a chance to process the parameters in some way. The engine also invokes these methods when running in external mode, but it passes the unprocessed changes to the S-function target. Thus, if it is essential that your S-function process parameter changes, you need to create a Target Language Compiler (TLC) file that inlines the S-function, including its parameter processing code, during the code generation process. For information on inlining S-functions, see “Inlining S-Functions” in the Simulink Coder Target Language Compiler documentation.

Run-Time Parameters

In this section...

“About Run-Time Parameters” on page 8-8

“Creating Run-Time Parameters” on page 8-9

“Updating Run-Time Parameters” on page 8-15

“Tuning Run-Time Parameters” on page 8-16

“Accessing Run-Time Parameters” on page 8-17

About Run-Time Parameters

You can create internal representations of external S-function dialog box parameters called *run-time parameters*. Every run-time parameter corresponds to one or more dialog box parameters and can have the same value and data type as its corresponding external parameters or a different value or data type. If a run-time parameter differs in value or data type from its external counterpart, the dialog parameter is said to have been transformed to create the run-time parameter. The value of a run-time parameter that corresponds to multiple dialog parameters is typically a function of the values of the dialog parameters. The Simulink engine allocates and frees storage for run-time parameters and provides functions for updating and accessing them, thus eliminating the need for S-functions to perform these tasks.

Run-time parameters facilitate the following kinds of S-function operations:

- Computed parameters

Often the output of a block is a function of the values of several dialog parameters. For example, suppose a block has two parameters, the volume and density of some object, and the output of the block is a function of the input signal and the mass of the object. In this case, the mass can be viewed as a third internal parameter computed from the two external parameters, volume and density. An S-function can create a run-time parameter corresponding to the computed weight, thereby eliminating the need to provide special case handling for weight in the output computation. See “Creating Run-Time Parameters from Multiple S-Function Parameters” on page 8-11 for more information.

- Data type conversions

Often a block needs to change the data type of a dialog parameter to facilitate internal processing. For example, suppose that the output of the block is a function of the input and a dialog parameter and the input and dialog parameter are of different data types. In this case, the S-function can create a run-time parameter that has the same value as the dialog parameter but has the data type of the input signal, and use the run-time parameter in the computation of the output.

- Code generation

During code generation, the Simulink Coder product writes all run-time parameters automatically to the `model.rtw` file, eliminating the need for the S-function to perform this task via an `mdlRTW` method.

The `sfcdemo_runtime` Simulink model contains four example S-functions that create run-time parameters.

Creating Run-Time Parameters

In a Level-2 MATLAB S-function, you create run-time parameters associated with all the tunable dialog parameters. Use the run-time object's `AutoRegRuntimePrms` method in the `PostPropagationSetup` callback method to register the block's run-time parameters. For example:

```
block.AutoRegRuntimePrms;
```

In a C S-function, you can create run-time parameters in a number of ways. The following sections describe different methods for creating run-time parameters in a C S-function.

Creating Run-Time Parameters All at Once

Use the `SimStruct` function `ssRegAllTunableParamsAsRunTimeParams` in `mdlSetWorkWidths` to create run-time parameters corresponding to all tunable parameters. This function requires that you pass it an array of names, one for each run-time parameter. The Simulink Coder product uses these names as the names of the parameters during code generation. The S-function `sfun_runtime1.c` shows how to create run-time parameters all at once.

This approach to creating run-time parameters assumes that there is a one-to-one correspondence between an S-function run-time parameters and its tunable dialog parameters. This might not be the case. For example, an S-function might want to use a computed parameter whose value is a function of several dialog parameters. In such cases, the S-function might need to create the run-time parameters individually.

Creating Run-Time Parameters Individually

To create run-time parameters individually, the S-function `mdlSetWorkWidths` method should

- 1 Specify the number of run-time parameters it intends to use, using `ssSetNumRunTimeParams`.
- 2 Use `ssRegDlgParamAsRunTimeParam` to register a run-time parameter that corresponds to a single dialog parameter, even if there is a data type transformation, or `ssSetRunTimeParamInfo` to set the attributes of a run-time parameter that corresponds to more than one dialog parameter.

The following example uses `ssRegDlgParamAsRunTimeParam` and is taken from the S-function `sfun_runtime3.c`. This example creates a run-time parameter directly from the dialog parameter and with the same data type as the first input port's signal.

```
static void mdlSetWorkWidths(SimStruct *S)
{
    /* Get data type of input to use for run-time parameter */
    DTypeId      dtId      = ssGetInputPortDataType(S, 0);

    /* Define name of run-time parameter */
    const char_T *rtParamName = "Gain";

    ssSetNumRunTimeParams(S, 1); /* One run-time parameter */
    if (ssGetErrorStatus(S) != NULL) return;
    ssRegDlgParamAsRunTimeParam(S, GAIN_IDX, 0, rtParamName, dtId);
}
#endif /* MDL_SET_WORK_WIDTHS */
```

The next example uses `ssSetRunTimeParamInfo` and is taken from the S-function `sfun_runtime2.c`.

```

static void mdlSetWorkWidths(SimStruct *S)
{
    ssParamRec p; /* Initialize an ssParamRec structure */
    int      dIlgP = GAIN_IDX; /* Index of S-function parameter */

    /* Configure run-time parameter information */
    p.name          = "Gain";
    p.nDimensions   = 2;
    p.dimensions    = (int_T *) mxGetDimensions(GAIN_PARAM(S));
    p.dataTypeId    = SS_DOUBLE;
    p.complexSignal = COMPLEX_NO;
    p.data          = (void *)mxGetPr(GAIN_PARAM(S));
    p.dataAttributes = NULL;
    p.nDlgParamIndices = 1;
    p.dlgParamIndices = &dIlgP;
    p.transformed    = false;
    p.outputAsMatrix = false;

    /* Set number of run-time parameters */
    if (!ssSetNumRunTimeParams(S, 1)) return;

    /* Set run-time parameter information */
    if (!ssSetRunTimeParamInfo(S, 0, &p)) return;
}

```

The S-function `sfun_runtime2.c` defines the parameters `GAIN_IDX` and `GAIN_PARAM` as follows, prior to using these parameters in `mdlSetWorkWidths`.

```

#define GAIN_IDX 1
#define GAIN_PARAM(S) ssGetSFcnParam(S,GAIN_IDX)

```

Creating Run-Time Parameters from Multiple S-Function Parameters

Use the `ssSetRunTimeParamInfo` function in `mdlSetWorkWidths` to create run-time parameters as a function of multiple S-function parameters. For example, consider an S-function with two S-function parameters, density and volume. The S-function inputs a force (F) and outputs an acceleration (a). The `mdlOutputs` method calculates the force using the equation $F=m*a$, where the mass (m) is the product of the density and volume.

The S-function `sfun_runtime4.c` implements this example using a single run-time parameter to store the mass. The S-function begins by defining the run-time parameter data type, as well as variables associated with volume and density.

```
#define RUN_TIME_DATA_TYPE SS_DOUBLE
#if RUN_TIME_DATA_TYPE == SS_DOUBLE
typedef real_T RunTimeDataType;
#endif

#define VOL_IDX 0
#define VOL_PARAM(S) ssGetSFcnParam(S,VOL_IDX)

#define DEN_IDX 1
#define DEN_PARAM(S) ssGetSFcnParam(S,DEN_IDX)
```

The `mdlSetWorkWidths` method then initializes the run-time parameter, as follows.

```
static void mdlSetWorkWidths(SimStruct *S)
{
    ssParamRec p; /* Initialize an ssParamRec structure */
    int         dlg[2]; /* Stores dialog indices */
    real_T vol      = *mxGetPr(VOL_PARAM(S));
    real_T den      = *mxGetPr(DEN_PARAM(S));
    RunTimeDataType *mass;

    /* Initialize dimensions for the run-time parameter as a
     * local variable. The Simulink engine makes a copy of this
     * information to store in the run-time parameter. */
    int_T massDims[2] = {1,1};

    /* Allocate memory for the run-time parameter data. The S-function
     * owns this memory location. The Simulink engine does not copy the data.*/
    if ((mass=(RunTimeDataType*)malloc(1)) == NULL) {
        ssSetErrorStatus(S,"Memory allocation error");
        return;
    }

    /* Store the pointer to the memory location in the S-function
     * userdata. Since the S-function owns this data, it needs to
```

```

    * free the memory during mdlTerminate */
    ssSetUserData(S, (void*)mass);

    /* Call a local function to initialize the run-time
    * parameter data. The Simulink engine checks that the data is not
    * empty so an initial value must be stored. */
    calcMass(mass, vol, den);

    /* Specify mass as a function of two S-function dialog parameters */
    dlg[0] = VOL_IDX;
    dlg[1] = DEN_IDX;

    /* Configure run-time parameter information. */
    p.name          = "Mass";
    p.nDimensions   = 2;
    p.dimensions    = massDims;
    p.dataTypeId    = RUN_TIME_DATA_TYPE;
    p.complexSignal = COMPLEX_NO;
    p.data          = mass;
    p.dataAttributes = NULL;
    p.nDlgParamIndices = 2;
    p.dlgParamIndices = &dlg
    p.transformed    = RTPARAM_TRANSFORMED;
    p.outputAsMatrix = false;

    /* Set number of run-time parameters */
    if (!ssSetNumRunTimeParams(S, 1)) return;

    /* Set run-time parameter information */
    if (!ssSetRunTimeParamInfo(S,0,&p)) return;

}

```

The local function `calcMass` updates the run-time parameter value in `mdlSetWorkWidths` and in `mdlProcessParameters`, when the values of density or volume are tuned.

```

/* Function: calcMass =====
* Abstract:
*     Local function to calculate the mass as a function of volume

```

```
    *    and density.
    */
static void calcMass(RuntimeDataType *mass, real_T vol, real_T den)
{
    *mass = vol * den;
}
```

The `mdlOutputs` method uses the stored mass to calculate the force.

```
/* Function: mdlOutputs =====
 * Abstract:
 *
 *    Output acceleration calculated as input force divided by mass.
 */
static void mdlOutputs(SimStruct *S, int_T tid)
{
    real_T *y1          = ssGetOutputPortRealSignal(S,0);
    InputRealPtrsType uPtrs = ssGetInputPortRealSignalPtrs(S,0);
    RuntimeDataType *mass =
        (RuntimeDataType *)((ssGetRunTimeParamInfo(S,0))->data);

    /*
     * Output acceleration = force / mass
     */
    y1[0] = (*uPtrs[0]) / *mass;
}
```

Lastly, the `mdlTerminate` method frees the memory allocated for the run-time parameter in `mdlSetWorkWidths`.

```
/* Function: mdlTerminate =====
 * Abstract:
 *    Free the user data.
 */
static void mdlTerminate(SimStruct *S)
{
    /* Free memory used to store the run-time parameter data*/
    RuntimeDataType *mass = ssGetUserData(S);
    if (mass != NULL) {
        free(mass);
    }
}
```

```
    }
}
```

To run the example, open the Simulink model:

```
sfcndemo_runtime
```

Updating Run-Time Parameters

Whenever you change the values of S-function dialog parameters during simulation, the Simulink engine invokes the S-function `mdlCheckParameters` method to validate the changes. If the changes are valid, the engine invokes the S-function `mdlProcessParameters` method at the beginning of the next time step. This method should update the S-function run-time parameters to reflect the changes in the dialog parameters.

In a Level-2 MATLAB S-function, update the run-time parameters using the `AutoUpdateRuntimePrms` method in the `ProcessParameters` callback method. For example:

```
block.AutoUpdateRuntimePrms;
```

In a C S-function, update the run-time parameters using the method appropriate for how the run-time parameters were created, as described in the following sections.

Updating All Parameters at Once

In a C MEX S-function, if there is a one-to-one correspondence between the S-function tunable dialog parameters and the run-time parameters, i.e., the run-time parameters were registered using `ssRegAllTunableParamsAsRunTimeParams`, the S-function can use the `SimStruct` function `ssUpdateAllTunableParamsAsRunTimeParams` to accomplish this task. This function updates each run-time parameter to have the same value as the corresponding dialog parameter. See `sfun_runtime1.c` for an example.

Updating Parameters Individually

If there is not a one-to-one correspondence between the S-function dialog and run-time parameters or the run-time parameters are transformed versions of the dialog parameters, the `mdlProcessParameters` method must update

each parameter individually. Choose the method used to update the run-time parameter based on how it was registered.

If you register a run-time parameter using `ssSetRunTimeParamInfo`, the `mdlProcessParameters` method uses `ssUpdateRunTimeParamData` to update the run-time parameter, as shown in `sfun_runtime2.c`. This function updates the data field in the parameter's attributes record, `ssParamRec`, with a new value. You cannot directly modify the `ssParamRec`, even though you can obtain a pointer to the `ssParamRec` using `ssGetRunTimeParamInfo`.

If you register a run-time parameter using `ssRegDlgParamAsRunTimeParam`, the `mdlProcessParameters` method uses `ssUpdateDlgParamAsRunTimeParam` to update the run-time parameter, as is shown in `sfun_runtime3.c`.

Updating Parameters as Functions of Multiple S-Function Parameters

If you register a run-time parameter as a function of multiple S-function parameters, the `mdlProcessParameters` method uses `ssUpdateRunTimeParamData` to update the run-time parameter.

The S-function `sfun_runtime4.c` provides an example. In this example, the `mdlProcessParameters` method calculates a new value for the run-time parameter and passes the value to the pointer of the run-time parameter's memory location, which was allocated during the call to `mdlSetWorkWidths`. The `mdlProcessParameters` method then passes the updated run-time parameter's pointer to `ssUpdateRunTimeParamData`.

Tuning Run-Time Parameters

Tuning a dialog parameter tunes the corresponding run-time parameter during simulation and in code generated only if the dialog parameter meets the following conditions:

- The S-function marks the dialog parameter as tunable, using `ssSetSFcnParamTunable`.
- The dialog parameter is a MATLAB array of values with a data type supported by the Simulink product.

Note that you cannot tune a run-time parameter whose value is a cell array or structure.

Accessing Run-Time Parameters

You can easily access run-time parameters from the S-function code. In order to access run-time parameter data, choose one of the following methods based on the data type.

- If the data is of type double:

```
real_T *dataPtr = (real_T *) ssGetRunTimeParamInfo(S, #)->data;
```

- If the parameter is complex, the real and imaginary parts of the data are interleaved. For example, if a user enters the following:

```
K = [1+2i, 3+4i; 5+6i, 7+8i]
```

the matrix that is generated is

```
K =
    1+2i    3+4i
    5+6i    7+8i
```

The memory for this matrix is laid out as

```
[1, 2, 5, 6, 3, 4, 7, 8]
```

To access a complex run-time parameter from the S-function code:

```
for (i = 0; i<width; i++)
{
    real_T realData = dataPtr[(2*i)];
    real_T imagData = dataPtr[(2*i)+1];
}
```

Note Matrix elements are written out in column-major format. Real and imaginary values are interleaved.

Input and Output Ports

In this section...

- “Creating Input Ports for C S-Functions” on page 8-18
- “Creating Input Ports for Level-2 MATLAB S-Functions” on page 8-22
- “Creating Output Ports for C S-Functions” on page 8-24
- “Creating Output Ports for Level-2 MATLAB S-Functions” on page 8-25
- “Scalar Expansion of Inputs” on page 8-25
- “Masked Multiport S-Functions” on page 8-27

Creating Input Ports for C S-Functions

To create and configure input ports, the `mdlInitializeSizes` method should first specify the number of S-function input ports, using `ssSetNumInputPorts`. Then, for each input port, the method should specify

- The dimensions of the input port (see “Initializing Input Port Dimensions” on page 8-19)

If you want your S-function to inherit its dimensionality from the port to which it is connected, you should specify that the port is dynamically sized in `mdlInitializeSizes` (see “Sizing an Input Port Dynamically” on page 8-20).

- Whether the input port allows scalar expansion of inputs (see “Scalar Expansion of Inputs” on page 8-25)
- Whether the input port has direct feedthrough, using `ssSetInputPortDirectFeedThrough`

A port has direct feedthrough if the input is used in either the `mdlOutputs` or `mdlGetTimeOfNextVarHit` functions. The direct feedthrough flag for each input port can be set to either 1=yes or 0=no. It should be set to 1 if the input, `u`, is used in the `mdlOutputs` or `mdlGetTimeOfNextVarHit` routine. Setting the direct feedthrough flag to 0 tells the Simulink engine that `u` is not used in either of these S-function routines. Violating this leads to unpredictable results.

- The data type of the input port, if not the default `double`

Use `ssSetInputPortDataType` to set the input port's data type. If you want the data type of the port to depend on the data type of the port to which it is connected, specify the data type as `DYNAMICALLY_TYPED`. In this case, you must provide implementations of the `mdlSetInputPortDataType` and `mdlSetDefaultPortDataTypes` methods to enable the data type to be set correctly during signal propagation.

- The numeric type of the input port, if the port accepts complex-valued signals

Use `ssSetInputPortComplexSignal` to set the input port's numeric type. If you want the numeric type of the port to depend on the numeric type of the port to which it is connected, specify the numeric type as `COMPLEX_INHERITED`. In this case, you must provide implementations of the `mdlSetInputPortComplexSignal` and `mdlSetDefaultPortComplexSignals` methods to enable the numeric type to be set correctly during signal propagation.

You can configure additional input port properties using other S-function macros. See “Input and Output Ports” on page 10-7 in the “SimStruct Macros and Functions Listed by Usage” section for more information.

Note The `mdlInitializeSizes` method must specify the number of ports before setting any properties. If it attempts to set a property of a port that doesn't exist, it is accessing invalid memory and a segmentation violation occurs.

Initializing Input Port Dimensions

You can set input port dimensions using one of the following macros:

- If the input signal must be one-dimensional and the input port width is w , use

```
ssSetInputPortWidth(S, inputPortIdx, w)
```

- If the input signal must be a matrix of dimension m -by- n , use

```
ssSetInputPortMatrixDimensions(S, inputPortIdx, m, n)
```

- Otherwise, if the input signal can have either one or two dimensions, use
`ssSetInputPortDimensionInfo(S, inputPortIdx, dimsInfo)`

You can use this function to fully or partially initialize the port dimensions (see next section).

Sizing an Input Port Dynamically

If your S-function does not require that its input signals have specific dimensions, you can set the dimensionality of the input ports to match the dimensionality of the signals connected to them.

To dynamically dimension an input port:

- Specify some or all of the dimensions of the input port as dynamically sized in `mdlInitializeSizes`.

If the input port can accept a signal of any dimensionality, use

```
ssSetInputPortDimensionInfo(S, inputPortIdx, DYNAMIC_DIMENSION)
```

to set the dimensionality of the input port.

If the input port can accept only vector (1-D) signals but the signals can be of any size, use

```
ssSetInputPortWidth(S, inputPortIdx, DYNAMICALLY_SIZED)
```

to specify the dimensionality of the input port.

If the input port can accept only matrix signals but can accept any row or column size, use

```
ssSetInputPortMatrixDimensions(S, inputPortIdx,  
    DYNAMICALLY_SIZED, DYNAMICALLY_SIZED)
```

- Provide an `mdlSetInputPortDimensionInfo` method that sets the dimensions of the input port to the size of the signal connected to it.

The Simulink engine invokes this method during signal propagation when it has determined the dimensionality of the signal connected to the input port.

- Provide an `mdlSetDefaultPortDimensionInfo` method that sets the dimensions of the block's ports to a default value. See `sfun_dynsize.c` for an example that implements this macro.

The engine invokes this method during signal propagation when it cannot determine the dimensionality of the signal connected to some or all of the block's input ports. This can happen, for example, if an input port is unconnected. If the S-function does not provide this method, the signal propagation routine sets the dimension of the block's ports to 1-D scalar.

Example: Defining Multiple S-Function Input Ports

The following code in `mdlInitializeSizes` configures an S-function with two input ports. See “Input and Output Ports” on page 10-7 in the “SimStruct Macros and Functions Listed by Usage” section for more information on the macros used in this example.

```
if (!ssSetNumInputPorts(S, 2)) return;

for (i = 0; i < 2; i++) {
    /* Input has direct feedthrough */
    ssSetInputPortDirectFeedThrough(S, i, 1);

    /* Input supports frames:
       Requires a DSP System Toolbox license*/
    ssSetInputPortFrameData(S, i, FRAME_YES);

    /* Input is a real signal */
    ssSetInputPortComplexSignal(S, i, COMPLEX_NO);

    /* Input is a dynamically sized 2-D matrix */
    ssSetInputPortMatrixDimensions(S, i,
        DYNAMICALLY_SIZED, DYNAMICALLY_SIZED);

    /* Input inherits its sample time */
    ssSetInputPortSampleTime(S, i, INHERITED_SAMPLE_TIME);

    /* Input signal must be contiguous */
    ssSetInputPortRequiredContiguous(S, i, 1);

    /* The input port cannot share memory */
```

```
    ssSetInputPortOverWritable(S, i, 0);  
}
```

During signal propagation, the Simulink engine calls this S-function's `mdlSetInputPortDimensionInfo` macro to initialize the input port dimensions. In this example, `mdlSetInputPortDimensionInfo` sets the input dimensions to the candidate dimensions passed to the macro by the engine.

```
#if defined(MATLAB_MEX_FILE)  
#define MDL_SET_INPUT_PORT_DIMENSION_INFO  
static void mdlSetInputPortDimensionInfo(SimStruct      *S,  
                                         int_T        port,  
                                         const DimsInfo_T *dimsInfo)  
{  
    if(!ssSetInputPortDimensionInfo(S, port, dimsInfo)) return;  
}  
#endif
```

For an example that configures an S-function with multiple input and output ports, open the Simulink model `sfcndemo_sfund_multiport` and inspect the S-function `sfund_multiport.c`.

Creating Input Ports for Level-2 MATLAB S-Functions

To create and configure input ports, the `setup` method should first specify the number of S-function input ports, using the run-time object `NumInputPorts` property. Next, if all input ports inherit their functional properties (data type, dimensions, complexity, and sampling mode) from their input signals, include the following line in the `setup` method:

```
block.SetPreCompInpPortInfoToDynamic;
```

Then, for each input port, the `setup` method can specify

- The dimensions of the input port, using `block.InputPort(n).Dimensions`.

To individually specify that an input port's dimensions are dynamically sized, assign a value of -1 to the dimensions. In this case, you can implement the `SetInputPortDimensions` method to set the dimensions during signal propagation.

- Whether the input port has direct feedthrough, using `block.InputPort(n).DirectFeedthrough`.

A port has direct feedthrough if the input is used in the `Outputs` functions to calculate either the outputs or the next sample time hit. The direct feedthrough flag for each input port can be set to either 1=yes or 0=no. Setting the direct feedthrough flag to 0 tells the Simulink engine that `u` is not used to calculate the outputs or next sample time hit. Violating this leads to unpredictable results.

- The data type of the input port, using `block.InputPort(n).DatatypeID`. See the explanation for the “DatatypeID” property in the `Simulink.BlockData` data object reference page for a list of valid data type IDs.

If you want the data type of the port to depend on the data type of the port to which it is connected, specify the data type as `-1`. In this case, you can implement the `SetInputPortDataType` method to set the data type during signal propagation.

- The numeric type of the input port, if the port accepts complex-valued signals, using `block.InputPort(n).Complexity`.

If you want the numeric type of the port to depend on the numeric type of the port to which it is connected, specify the numeric type as `'Inherited'`. In this case, you can implement the `SetInputPortComplexSignal` method to set the numeric type during signal propagation.

- The sampling mode of the input port, using `block.InputPort(n).SamplingMode`.

If you want the sampling mode of the port to depend on the sampling mode of the port to which it is connected, specify the sampling mode as `'Inherited'`. In this case, you can implement the `SetInputPortComplexSignal` method to set the sampling mode during signal propagation. If your S-function has multiple output ports, you must implement the `SetInputPortComplexSignal` method if any of the ports has an inherited sampling mode.

For an example that configures a Level-2 MATLAB S-function with multiple input and output ports, open the model `sldemo_msfcn_lms` and inspect the S-function `adapt_lms.m`.

Creating Output Ports for C S-Functions

To create and configure output ports, the `mdlInitializeSizes` method should first specify the number of S-function output ports, using `ssSetNumOutputPorts`. Then, for each output port, the method should specify

- Dimensions of the output port

You can set output port dimensions using one of the following macros:

- `ssSetOutputPortDimensionInfo`
- `ssSetOutputPortMatrixDimensions`
- `ssSetOutputPortVectorDimension`
- `ssSetOutputPortWidth`

If you want the port's dimensions to depend on block connectivity, set the dimensions to `DYNAMIC_DIMENSIONS` when using `ssSetOutputPortDimensionInfo` or to `DYNAMICALLY_SIZED` for all other macros. The S-function must then provide `mdlSetOutputPortDimensionInfo` and `mdlSetDefaultPortDimensionInfo` methods to ensure that output port dimensions are set to the correct values in code generation.

- Data type of the output port

Use `ssSetOutputPortDataType` to set the output port's data type. If you want the data type of the port to depend on block connectivity, specify the data type as `DYNAMICALLY_TYPED`. In this case, you must provide implementations of the `mdlSetOutputPortDataType` and `mdlSetDefaultPortDataTypes` methods to enable the data type to be set correctly during signal propagation.

- The numeric type of the output port, if the port outputs complex-valued signals

Use `ssSetOutputPortComplexSignal` to set the output port's numeric type. If you want the numeric type of the port to depend on the numeric type of the port to which it is connected, specify the numeric type as `COMPLEX_INHERITED`. In this case, you must provide implementations of the `mdlSetOutputPortComplexSignal` and `mdlSetDefaultPortComplexSignals` methods to enable the numeric type to be set correctly during signal propagation.

See “Creating Input Ports for C S-Functions” on page 8-18 for an example showing how to initialize an S-function input port. You use the same procedure to initialize the S-function output ports, but with the corresponding output port macro.

Creating Output Ports for Level-2 MATLAB S-Functions

To create output ports for Level-2 MATLAB S-functions the `setup` method should first specify the number of S-function output ports, using the run-time object `NumOutputPorts` property. Next, if all output ports inherit their functional properties (data type, dimensions, complexity, and sampling mode), include the following line in the `setup` method:

```
block.SetPreCompOutPortInfoToDynamic;
```

Configure the output ports exactly as you configure input ports. See “Creating Input Ports for Level-2 MATLAB S-Functions” on page 8-22 for a list of properties you can specify for each output port, substituting `OutputPort` for `InputPort` in each call to the run-time object.

Scalar Expansion of Inputs

Scalar expansion of inputs refers conceptually to the process of expanding scalar input signals to the same dimensions as wide input signals connected to other S-function input ports. This is done by setting each element of the expanded signal to the value of the scalar input.

- A Level-2 MATLAB S-function uses the default scalar expansion rules if the input and output ports are specified as dynamically sized (see “Scalar Expansion of Inputs and Parameters” in *Using Simulink*).
- A C MEX S-function’s `mdlInitializeSizes` method enables scalar expansion of inputs by setting the `SS_OPTION_ALLOW_INPUT_SCALAR_EXPANSION` option, using `ssSetOptions`.

With scalar expansion on, the S-function `mdlInitializeSizes` method should specify that the input and output ports are dynamically sized. The Simulink engine uses a default method to set the dimensions of the input and output ports. If the block has more than two inputs, the input signals can be scalar or wide signals, where the wide signals all have the same number of elements. In this case, the engine sets the dimensions of the output ports to the width

of the wide input signals and expands any scalar inputs to this width. If the wide inputs are driven by 1-D and 2-D vectors, the output is a 2-D vector signal, and the scalar inputs are expanded to a 2-D vector signal.

If scalar expansion is not on, the engine assumes that all ports (input and output ports) must have the same dimensions, and it sets all port dimensions to the same dimensions specified by one of the driving blocks.

Note The engine ignores the scalar expansion option if the S-function specifies or controls the dimensions of its input and output ports either by initializing the dimensions in `mdlInitializeSizes`, using `mdlSetInputPortWidth` and `mdlSetOutputPortWidth`, or using `mdlSetInputPortDimensionInfo`, `mdlSetOutputPortDimensionInfo`, and `mdlSetDefaultPortDimensionInfo`.

The best way to understand how to use scalar expansion is to consider the example `sfncdemo_sfun_multiport`. This model contains three S-function blocks, each with multiple input ports. The S-function `sfun_multiport.c` used in these blocks sets the `SS_OPTION_ALLOW_INPUT_SCALAR_EXPANSION` option in its `mdlInitializeSizes` method, allowing scalar expansion of the inputs. The S-function specifies that its inputs and outputs are dynamically sized. Therefore, during signal propagation, the engine sets the width of the input ports to the width of the signal connected to the port, and the width of the output ports to the width of any wide input signal. The `mdlOutputs` method performs an element-by-element sum on the input signals, expanding any scalar inputs, as needed.

```
/* Calculate an element-by-element sum of the input signals.
   yWidth is the width of the output signal. */

for (el = 0; el < yWidth; el++) {

    int_T port;
    real_T sum = 0.0;
    for (port = 0; port < nInputPorts; port++) {
        /* Get the input signal value */
        InputRealPtrsType uPtrs =
            ssGetInputPortRealSignalPtrs(S,port);
```

```
    if (el < ssGetInputPortWidth(S,port)) {
        /* Input is a wide signal. Use specific element */
        sum = sum + ((real_T)signs[port] * (*uPtrs[el]));
    } else {
        /* Use the scalar value to expand the signal */
        sum = sum + ((real_T)signs[port] * (*uPtrs[0]));
    }
}
}
```

Masked Multiport S-Functions

If you are developing masked multiport S-function blocks whose number of ports varies based on some parameter, and want to place them in a Simulink library, you must specify that the mask modifies the appearance of the block. To do this, execute the command

```
set_param(blockname, 'MaskSelfModifiable', 'on')
```

at the MATLAB command prompt before saving the library, where *blockname* is the full path to the block. Failure to specify that the mask modifies the appearance of the block means that an instance of the block in a model reverts to the number of ports in the library whenever you load the model or update the library link.

Custom Data Types

In this section...

“Custom Data Types in C S-Functions” on page 8-28

“Using Simulink Recognizable Data Types in C S-Functions” on page 8-28

“Using Opaque Data Types in C S-Functions” on page 8-29

“Using Custom Data Types in Level-2 MATLAB S-Functions” on page 8-30

Custom Data Types in C S-Functions

C S-Functions can communicate using user-defined data types. There are two broad categories for these data types:

- Simulink recognizable custom data types — These are custom data types from a `Simulink.AliasType`, `Simulink.Bus`, `Simulink.NumericType`, or an Enumerated data type that can also interact with other Simulink blocks.
- Opaque data types — These are data types for use only with S-Function blocks programmed to understand them. You might define opaque data types in cases in which other Simulink blocks do not need to use the data types.

Using Simulink Recognizable Data Types in C S-Functions

To register a custom data type recognizable by Simulink, the S-function `mdlInitializeSizes` routine must register the data type, using `ssRegisterTypeFromNamedObject`.

For example, the following code placed at the beginning of `mdlInitializeSizes` defines a custom data type from a `Simulink.AliasType` object named `u8` in the MATLAB workspace. The example then assigns the custom data type to the first output port.

```
int id1;  
ssRegisterTypeFromNamedObject(S, "u8", &id1);  
ssSetOutputPortDataType(S, 0, id1);
```

In addition, you can use the identifier `id1` to assign this data type to S-function parameters, DWork vectors, and input ports.

Using Opaque Data Types in C S-Functions

For cases in which S-Functions need to communicate using a data type that cannot be understood by Simulink, the S-function `mdlInitializeSizes` routine must:

- 1 Register the data type, using `ssRegisterDataType`.
- 2 Specify the amount of memory in bytes required to store an instance of the data type, using `ssSetDataTypeSize`.
- 3 Specify the value that represents zero for the data type, using `ssSetDataTypeZero`.

Define the user-defined data type in an external header file to include in the level 2 C S-Function.

```
/* Define the structure of the user-defined data type */
typedef struct{
    int8_T a;
    uint16_T b;
}myStruct;
```

Place the following code at the beginning of `mdlInitializeSizes` to set the size and zero representation of the custom data type `myStruct`.

```
/* Define variables */
int_T status;
DTypeId id;

myStruct tmp;

/* Register the user-defined data types */
id = ssRegisterDataType(S, "myStruct");
if(id == INVALID_DTYPE_ID) return;

/* Set the size of the user-defined data type */
status = ssSetDataTypeSize(S, id, sizeof(tmp));
```

```

if(status == 0) return;

/* Set the zero representation */
tmp.a = 0;
tmp.b = 1;
status = ssSetDataTypeZero(S, id, &tmp);

```

Note If you have Simulink Coder, you cannot use the software to generate code for S-functions that contain macros to define custom data types. You must use an inline S-function that accesses Target Language Compiler functions to generate code with custom data types. For more information, see “Inlining S-Functions”.

Using Custom Data Types in Level-2 MATLAB S-Functions

Level-2 MATLAB S-functions do not support defining custom data types within the S-function. However, input and output ports can inherit their data types from a `Simulink.NumericType` or `Simulink.AliasType`. For example, the S-function in the following model inherits its input data type from the Constant block:

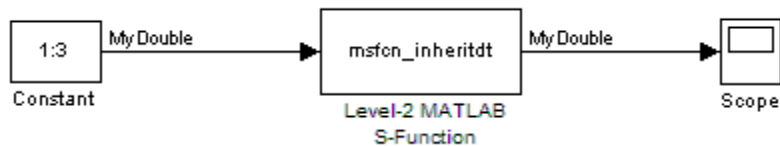

The Constant block’s **Output data type** field contains the value `MyDouble`, which is a `Simulink.NumericType` defined in the MATLAB workspace with the following lines of code:

```

MyDouble = Simulink.NumericType;
MyDouble.IsAlias = 1;

```

The input and output ports of the Level-2 MATLAB S-function `msfcn_inheritdt.m` inherit their data types. When the Simulink engine

performs data type propagation, it assigns the data type `MyDouble` to these ports.

You can define a fixed-point data type within a Level-2 MATLAB S-function, using one of the following three methods:

- `RegisterDataTypeFxpBinaryPoint` registers a fixed-point data type with binary point-only scaling
- `RegisterDataTypeFxpFSlopeFixExpBias` registers a fixed-point data type with [Slope Bias] scaling specified in terms of fractional slope, fixed exponent, and bias
- `RegisterDataTypeFxpSlopeBias` registers a data type with [Slope Bias] scaling

Note If the registered data type is not one of the Simulink built-in data types, you must have a Fixed-Point Designer™ license.

If you have Fixed-Point Designer, inspect the example models and S-functions provided with the software for examples using the macros for defining fixed-point data types.

Sample Times

In this section...

“About Sample Times” on page 8-32

“Block-Based Sample Times” on page 8-33

“Specifying Port-Based Sample Times” on page 8-37

“Hybrid Block-Based and Port-Based Sample Times” on page 8-43

“Multirate S-Function Blocks” on page 8-44

“Multirate S-Functions and Sample Time Hit Calculations” on page 8-46

“Synchronizing Multirate S-Function Blocks” on page 8-46

“Specifying Model Reference Sample Time Inheritance” on page 8-47

About Sample Times

You can specify the sample-time behavior of your S-functions in `mdlInitializeSampleTimes`. Your S-function can inherit its rates from the blocks that drive it or define its own rates.

You can specify your S-function rates (i.e., sample times) as

- Block-based sample times
- Port-based sample times
- Hybrid block-based and port-based sample times

With block-based sample times, the S-function specifies a set of operating rates for the block as a whole during the initialization phase of the simulation. With port-based sample times, the S-function specifies a sample time for each input and output port individually during initialization. During the simulation phase, with block-based sample times, the S-function processes all inputs and outputs each time a sample hit occurs for the block. By contrast, with port-based sample times, the block processes a particular port only when a sample hit occurs for that port.

For example, consider two sample rates, 0.5 and 0.25 seconds, respectively:

- In the block-based method, selecting 0.5 and 0.25 directs the block to execute inputs and outputs at 0.25 second increments.
- In the port-based method, setting the input port to 0.5 and the output port to 0.25 causes the block to process inputs at 2 Hz and outputs at 4 Hz.

You should use port-based sample times if your application requires unequal sample rates for input and output execution or if you do not want the overhead associated with running input and output ports at the highest sample rate of your block.

In some applications, an S-Function block might need to operate internally at one or more sample rates while inputting or outputting signals at other rates. The hybrid block- and port-based method of specifying sample rates allows you to create such blocks.

In typical applications, you specify only one block-based sample time. Advanced S-functions might require the specification of port-based or multiple block sample times.

Block-Based Sample Times

Level-2 MATLAB S-functions specify block-based sample times in their `setup` method. Use the line

```
block.SampleTimes = [sampleTime offsetTime];
```

to specify the sample time. Use a value of `[-1 0]` to indicate an inherited sample time. See “Specify Sample Time” in *Using Simulink* for a complete list of valid sample times.

C MEX S-functions specify block-based sample time information in

- `mdlInitializeSizes`
- `mdlInitializeSampleTimes`

The next two sections discuss how to specify block-based sample times for C MEX S-functions. A third section presents a simple example that shows how to specify sample times in `mdlInitializeSampleTimes`. For a detailed example, see `mixedm.c`.

Specifying the Number of Sample Times in `mdlInitializeSizes`

To configure your S-function for block-based sample times, use

```
ssSetNumSampleTimes(S,numSampleTimes);
```

where `numSampleTimes > 0`. This tells the Simulink engine that your S-function has block-based sample times. The engine calls `mdlInitializeSampleTimes`, which in turn sets the sample times.

Setting Sample Times and Specifying Function Calls in `mdlInitializeSampleTimes`

`mdlInitializeSampleTimes` specifies two pieces of execution information:

- Sample and offset times — In `mdlInitializeSampleTimes`, you must specify the sampling period and offset for each sample time using `ssSetSampleTime` and `ssSetOffsetTime`. If applicable, you can calculate the appropriate sampling period and offset prior to setting them, for example, by computing the best sample time for the block based on the S-function dialog parameters obtained using `ssGetSFcnParam`.
- Function calls — In `mdlInitializeSampleTimes`, use `ssSetCallSystemOutput` to specify the output elements that are performing function calls. See `seesfun_fcncall.c` for an example and “Function-Call Subsystems and S-Functions” on page 8-59 for an explanation of this S-function.

You specify the sample times as pairs [*sample_time*, *offset_time*], using these macros

```
ssSetSampleTime(S, sampleTimePairIndex, sample_time)
ssSetOffsetTime(S, offsetTimePairIndex, offset_time)
```

where *sampleTimePairIndex* and *offsetTimePairIndex* starts at 0.

The valid sample time pairs are (uppercase values are macros defined in `simstruc.h`):

```
[CONTINUOUS_SAMPLE_TIME, 0.0 ]
[CONTINUOUS_SAMPLE_TIME, FIXED_IN_MINOR_STEP_OFFSET]
[discrete_sample_period, offset ]
```

```
[VARIABLE_SAMPLE_TIME , 0.0 ]
```

Alternatively, you can specify that the sample time is inherited from the driving block, in which case the S-function can have only one sample time pair,

```
[INHERITED_SAMPLE_TIME, 0.0 ]
```

or

```
[INHERITED_SAMPLE_TIME, FIXED_IN_MINOR_STEP_OFFSET]
```

Note If your S-function inherits its sample time, you should specify whether it is safe to use the S-function in a submodel, i.e., a model referenced by another model. See “Specifying Model Reference Sample Time Inheritance” on page 8-47 for more information.

The following guidelines might help in specifying sample times:

- A continuous function that changes during minor integration steps should register the [CONTINUOUS_SAMPLE_TIME, 0.0] sample time.
- A continuous function that does not change during minor integration steps should register the [CONTINUOUS_SAMPLE_TIME, FIXED_IN_MINOR_STEP_OFFSET] sample time.
- A discrete function that changes at a specified rate should register the discrete sample time pair

```
[discrete_sample_period, offset]
```

where

```
discrete_sample_period > 0.0
```

and

```
0.0 <= offset < discrete_sample_period
```

- A discrete function that changes at a variable rate should register the variable-step discrete [VARIABLE_SAMPLE_TIME, 0.0] sample time. In C MEX S-functions, the `mdlGetTimeOfNextVarHit` function is called to get the time of the next sample hit for the variable-step discrete task. The `VARIABLE_SAMPLE_TIME` can be used with variable-step solvers only.

If your function has no intrinsic sample time, you must indicate that it is inherited according to the following guidelines:

- A function that changes as its input changes, even during minor integration steps, should register the [INHERITED_SAMPLE_TIME, 0.0] sample time.
- A function that changes as its input changes, but doesn't change during minor integration steps (meaning, is held during minor steps), should register the [INHERITED_SAMPLE_TIME, FIXED_IN_MINOR_STEP_OFFSET] sample time.

To check for a sample hit during execution (in `mdlOutputs` or `mdlUpdate`), use the `ssIsSampleHit` or `ssIsContinuousTask` macro. For example, use the following code fragment to check for a continuous sample hit:

```
if (ssIsContinuousTask(S,tid)) {  
}
```

To determine whether the third (discrete) task has a hit, use the following code fragment:

```
if (ssIsSampleHit(S,2,tid) {  
}
```

The Simulink engine always assigns an index of 0 to the continuous sample rate, if it exists, however you get incorrect results if you use `ssIsSampleHit(S,0,tid)`.

Example: mdlInitializeSampleTimes

This example specifies that there are two discrete sample times with periods of 0.01 and 0.5 seconds.

```
static void mdlInitializeSampleTimes(SimStruct *S)  
{
```

```

    ssSetSampleTime(S, 0, 0.01);
    ssSetOffsetTime(S, 0, 0.0);
    ssSetSampleTime(S, 1, 0.5);
    ssSetOffsetTime(S, 1, 0.0);
} /* End of mdlInitializeSampleTimes. */

```

Specifying Port-Based Sample Times

Port-based sample times cannot be used with S-functions that have neither input ports nor output ports. If an S-function uses port-based sample times and has no ports, the S-function produces errors when the Simulink model is updated or run. If the number of input or output ports on an S-function is variable, extra protection should be added into the S-function to ensure the total number of ports does not go to zero.

To use port-based sample times in a Level-2 MATLAB S-function:

- Specify the sample and offset times for each S-function port in the setup method. For example:

```

block.InputPort(1).SampleTime = [-1 0];
block.OutputPort(1).SampleTime = [-1 0];

```

The setup method should not specify a sample time for the block when using port-based sample times.

- Provide `SetInputPortSampleTime` and `SetOutputPortSampleTime` methods, even if your S-function does not inherit its port-based sample times.

To use port-based sample times in your C MEX S-function, you must specify the number of sample times as port-based in the S-function `mdlInitializeSizes` method:

```

ssSetNumSampleTimes(S, PORT_BASED_SAMPLE_TIMES)

```

You must also specify the sample time of each input and output port in the S-function `mdlInitializeSizes` method, using the following macros

```

ssSetInputPortSampleTime(S, idx, period)
ssSetInputPortOffsetTime(S, idx, offset)
ssSetOutputPortSampleTime(S, idx, period)

```

```
ssSetOutputPortOffsetTime(S, idx, offset)
```

Note `mdlInitializeSizes` should not contain any `ssSetSampleTime` or `ssSetOffsetTime` calls when you use port-based sample times.

The call to `ssSetNumSampleTimes` can be placed before or after the port-based sample times are actually specified in `mdlInitializeSizes`. However, if `ssSetNumSampleTimes` does not configure the S-function to use port-based sample times, any sample times set on the ports will be ignored.

For any given port, you can specify

- A specific sample time and period

For example, the following code sets the sample time of the S-function first input port to 0.1 and the offset time to 0.

```
ssSetInputPortSampleTime(S, 0, 0.1);  
ssSetInputPortOffsetTime(S, 0, 0);
```

- Inherited sample time, i.e., the port inherits its sample time from the port to which it is connected (see “Specifying Inherited Sample Time for a Port” on page 8-38)
- Constant sample time, i.e., the port’s input or output never changes (see “Specifying Constant Sample Time for a Port” on page 8-39)

Note To be usable in a triggered subsystem, all of your S-function ports must have either inherited or constant sample time (see “Configuring Port-Based Sample Times for Use in Triggered Subsystems” on page 8-41).

Specifying Inherited Sample Time for a Port

In a Level-2 MATLAB S-function, use a value of `[-1 0]` for the `SampleTime` property of each port to specify that the port inherits its sample time.

To specify that a port's sample time is inherited in a C MEX S-function, the `mdlInitializeSizes` method should set its period to `-1` and its offset to `0`. For example, the following code specifies inherited sample time for a C MEX S-function first input port:

```
ssSetInputPortSampleTime(S, 0, -1);
ssSetInputPortOffsetTime(S, 0, 0);
```

When you specify port-based sample times, the Simulink engine calls `mdlSetInputPortSampleTime` and `mdlSetOutputPortSampleTime` to determine the rates of inherited signals.

Once all rates have been determined, the engine calls `mdlInitializeSampleTimes`. Even though there is no need to initialize port-based sample times at this point, the engine invokes this method to give your S-function an opportunity to configure function-call connections. Your S-function must thus provide an implementation for this method regardless of whether it uses port-based sample times or function-call connections. Although you can provide an empty implementation, you might want to use it to check the appropriateness of the sample times that the block inherited during sample time propagation. Use `ssGetInputPortSampleTime` and `ssGetOutputPortSampleTime` in `mdlInitializeSampleTimes` to obtain the values of the inherited sample times. For example, the following code in `mdlInitializeSampleTimes` checks if the S-function first input inherited a continuous sample time.

```
if (!ssGetInputPortSampleTime(S,0)) {
    ssSetErrorStatus(S,"Cannot inherit a continuous sample time.")
};
```

Note If you specify that your S-function ports inherit their sample time, you should also specify whether it is safe to use the S-function in a submodel, i.e., a model referenced by another model. See “Specifying Model Reference Sample Time Inheritance” on page 8-47 for more information.

Specifying Constant Sample Time for a Port

If your S-function uses port-based sample times, it can specify that any of its ports has a constant sample time. This means that the signal entering

or leaving the port never changes from its initial value at the start of the simulation.

In a Level-2 MATLAB S-function, use the following line of code to specify a constant port-based sample time:

```
block.OutputPort(1).SampleTime = [inf 0];
```

The Simulink engine determines if a constant sample time is valid during sample-time propagation.

For C MEX S-functions, before specifying a constant sample time for an output port whose output depends on the S-function parameters, the S-function should use `ssGetInlineParameters` to check whether the **Inline parameters** option on the Model Configuration Parameters dialog box > **Optimization> Signal and Parameters** pane is on (see the “Optimization Pane: Signals and Parameters” reference page in *Simulink Graphical User Interface*). If this option is not selected, you can change the values the S-function parameters and hence its outputs during the simulation. In this case, the S-function can not specify a constant sample time for any ports whose outputs depend on the S-function parameters.

To specify constant sample time for a port, the S-function must perform the following tasks

- Use `ssSetOptions` to tell the Simulink engine that it supports constant port sample times in its `mdlInitializeSizes` method:

```
ssSetOptions(S, SS_OPTION_ALLOW_CONSTANT_PORT_SAMPLE_TIME);
```

Note By setting this option, your S-function is telling the engine that all of its ports support a constant sample time, including ports that inherit their sample times from other blocks. If any of the S-function inherited sample time ports cannot have a constant sample time, your S-function `mdlSetInputPortSampleTime` and `mdlSetOutputPortSampleTime` methods must check whether that port has inherited a constant sample time. If the port has inherited a constant sample time, your S-function should throw an error.

- Set the port's period to `inf` and its offset to 0, e.g.,

```
ssSetInputPortSampleTime(S, 0, mxGetInf());
ssSetInputPortOffsetTime(S, 0, 0);
```

- Check in `mdlOutputs` whether the method's `tid` argument equals `CONSTANT_TID` and if so, set the value of the port's output if it is an output port.

See `sfun_port_constant.c`, the source file for the `sfcn demo_port_constant` example, for an example of how to create ports with a constant sample time.

Configuring Port-Based Sample Times for Use in Triggered Subsystems

Level-2 MATLAB S-functions with port-based sample times cannot be placed in a triggered subsystem. You must modify your S-function to use block-based sample times if you need to include it in a triggered subsystem.

To use a C MEX S-function in a triggered subsystem, your port-based sample time S-function must perform the following tasks.

- Use `ssSetOptions` in the `mdlInitializeSizes` method to indicate the S-function can run in a triggered subsystem:

```
ssSetOptions(S,
SS_OPTION_ALLOW_PORT_SAMPLE_TIME_IN_TRIGSS);
```

- Set all of its ports to have either inherited or constant sample time in its `mdlInitializeSizes` method.
- Handle inheritance of a triggered sample time in `mdlSetInputPortSampleTime` and `mdlSetOutputPortSampleTime` methods as follows.

Since the S-function ports inherit their sample times, the Simulink engine invokes either `mdlSetInputPortSampleTime` or `mdlSetOutputPortSampleTime` during sample time propagation. The macro `ssSampleAndOffsetAreTriggered` can be used in these methods to determine if the S-function resides in a triggered subsystem. If the S-function does reside in a triggered subsystem, whichever method is called

must set the sample time and offset of the port for which it is called to `INHERITED_SAMPLE_TIME (-1)`.

Setting a port's sample time and offset both to `INHERITED_SAMPLE_TIME` indicates that the sample time of the port is triggered, i.e., it produces an output or accepts an input only when the subsystem in which it resides is triggered. The method must then also set the sample times and offsets of all of the other S-function input and output ports to have either triggered or constant sample time, whichever is appropriate, e.g.,

```
static void mdlSetInputPortSampleTime(SimStruct *S,
                                      int_T portIdx,
                                      real_T sampleTime
                                      real_T offsetTime)
{
    /* If the S-function resides in a triggered subsystem,
       the sample time and offset passed to this method
       are both equal to INHERITED_SAMPLE_TIME. Therefore,
       if triggered, the following lines set the sample time
       and offset of the input port to INHERITED_SAMPLE_TIME.*/

    ssSetInputPortSampleTime(S, portIdx, sampleTime);
    ssSetInputPortOffsetTime(S, portIdx, offsetTime);

    /* If triggered, set the output port to inherited, as well */

    if (ssSampleAndOffsetAreTriggered(sampleTime,offsetTime)) {
        ssSetOutputPortSampleTime(S, 0, INHERITED_SAMPLE_TIME);
        ssSetOutputPortOffsetTime(S, 0, INHERITED_SAMPLE_TIME);

        /* Note, if there are additional input and output ports
           on this S-function, they should be set to either
           inherited or constant at this point, as well. */
    }
}
```

There is no way for an S-function residing in a triggered subsystem to predict whether the Simulink engine will call `mdlSetInputPortSampleTime` or `mdlSetOutputPortSampleTime` to set its port sample times. For this reason, both methods must be able to set the sample times of all ports correctly so the engine has to call only one of the methods a single time.

- In `mdlUpdate` and `mdlOutputs`, use `ssGetPortBasedSampleTimeBlockIsTriggered` to check whether the S-function resides in a triggered subsystem and if so, use appropriate algorithms for computing its states and outputs.

See `sfun_port_triggered.c`, the source file for the `sfcndemo_port_triggered` example model, for an example of how to create an S-function that can be used in a triggered subsystem.

Hybrid Block-Based and Port-Based Sample Times

The hybrid method of assigning sample times combines the block-based and port-based methods. You first specify, in `mdlInitializeSizes`, the total number of rates at which your block operates, including both block and input and output rates, using `ssSetNumSampleTimes`.

You then set the `SS_OPTION_PORT_SAMPLE_TIMES_ASSIGNED` option, using `ssSetOptions`, to tell the simulation engine that you are going to use the port-based method to specify the rates of the input and output ports individually. Next, as in the block-based method, you specify the periods and offsets of all of the block's rates, both internal and external, using

```
ssSetSampleTime
ssSetOffsetTime
```

Finally, as in the port-based method, you specify the rates for each port, using

```
ssSetInputPortSampleTime(S, idx, period)
ssSetInputPortOffsetTime(S, idx, offset)
ssSetOutputPortSampleTime(S, idx, period)
ssSetOutputPortOffsetTime(S, idx, offset)
```

Note that each of the assigned port rates must be the same as one of the previously declared block rates. For an example S-function, see `mixedm.c`.

Note If you use the `SS_OPTION_PORT_SAMPLE_TIMES_ASSIGNED` option, your S-function cannot inherit sample times. Instead, you must specify the rate at which each input and output port runs.

Level-2 MATLAB S-functions support port-based sample times, but do not support hybrid block-based sample times.

Multirate S-Function Blocks

In a multirate S-Function block, you can encapsulate the code that defines each behavior in the `mdlOutputs` and `mdlUpdate` functions with a statement that determines whether a sample hit has occurred. In a C MEX S-function, the `ssIsSampleHit` macro determines whether the current time is a sample hit for a specified sample time. The macro has this syntax:

```
ssIsSampleHit(S, st_index, tid)
```

where `S` is the `SimStruct`, `st_index` identifies a specific sample time index, and `tid` is the task ID (`tid` is an argument to the `mdlOutputs` and `mdlUpdate` functions).

For example, these statements in a C MEX S-function specify three sample times: one for continuous behavior and two for discrete behavior.

```
ssSetSampleTime(S, 0, CONTINUOUS_SAMPLE_TIME);  
ssSetSampleTime(S, 1, 0.75);  
ssSetSampleTime(S, 2, 1.0);
```

In the `mdlUpdate` function, the following statement encapsulates the code that defines the behavior for the sample time of 0.75 second.

```
if (ssIsSampleHit(S, 1, tid)) {  
}
```

The second argument, 1, corresponds to the second sample time, 0.75 second.

Use the following lines to encapsulate the code that defines the behavior for the continuous sample hit:

```
if (ssIsContinuousTask(S,tid)) {  
}
```

In a Level-2 MATLAB S-function, use the `IsSampleHit` method to determine whether the current simulation time is one at which a task handled by this block is active.

Example of Defining a Sample Time for a Continuous Block

This example defines a sample time for a block that is continuous.

```
/* Initialize the sample time and offset. */  
static void mdlInitializeSampleTimes(SimStruct *S)  
{  
    ssSetSampleTime(S, 0, CONTINUOUS_SAMPLE_TIME);  
    ssSetOffsetTime(S, 0, 0.0);  
}
```

You must add this statement to the `mdlInitializeSizes` function.

```
ssSetNumSampleTimes(S, 1);
```

Example of Defining a Sample Time for a Hybrid Block

This example defines sample times for a hybrid S-Function block.

```
/* Initialize the sample time and offset. */  
static void mdlInitializeSampleTimes(SimStruct *S)  
{  
    /* Continuous state sample time and offset. */  
    ssSetSampleTime(S, 0, CONTINUOUS_SAMPLE_TIME);  
    ssSetOffsetTime(S, 0, 0.0);  
  
    /* Discrete state sample time and offset. */  
    ssSetSampleTime(S, 1, 0.1);  
    ssSetOffsetTime(S, 1, 0.025);  
}
```

In the second sample time, the offset causes the Simulink engine to call the `mdlUpdate` function at these times: 0.025 second, 0.125 second, 0.225 second, and so on, in increments of 0.1 second.

The following statement, which indicates how many sample times are defined, also appears in the `mdlInitializeSizes` function.

```
ssSetNumSampleTimes(S, 2);
```

Multirate S-Functions and Sample Time Hit Calculations

For fixed-step solvers, Simulink uses integer arithmetic, rather than floating-point arithmetic, to calculate the sample time hits. Consequently, task times are integer multiples of their corresponding sample time periods.

This calculation method becomes important if you consider performing Boolean logic based upon task times in multirate S-functions. For example, consider an S-function that has two sample times. The fact that `(ssIsSampleHit(S, idx1) == true && ssIsSampleHit(S, idx2) == true)`, does not guarantee that `ssGetTaskTime(S, idx1) == ssGetTaskTime(S, idx2)`.

Synchronizing Multirate S-Function Blocks

If tasks running at different rates need to share data, you must ensure that data generated by one task is valid when accessed by another task running at a different rate. You can use the `ssIsSpecialSampleHit` macro in the `mdlUpdate` or `mdlOutputs` routine of a multirate S-function to ensure that the shared data is valid. This macro returns `true` if a sample hit has occurred at one rate and a sample hit has also occurred at another rate in the same time step. It thus permits a higher rate task to provide data needed by a slower rate task at a rate the slower task can accommodate.

Suppose, for example, that your model has an input port operating at one rate (with a sample time index of 0) and an output port operating at a slower rate (with a sample time index of 1). Further, suppose that you want the output port to output the value currently on the input. The following example illustrates usage of this macro.

```
if (ssIsSampleHit(S, 0, tid) {  
    if (ssIsSpecialSampleHit(S, 0, 1, tid) {
```

```
        /* Transfer input to output memory. */
        ...
    }
}

if (ssIsSampleHit(S, 1, tid) {
    /* Emit output. */
    ...
}
```

In this example, the first block runs when a sample hit occurs at the input rate. If the hit also occurs at the output rate, the block transfers the input to the output memory. The second block runs when a sample hit occurs at the output rate. It transfers the output in its memory area to the block's output.

Note that higher-rate tasks always run before slower-rate tasks. Thus, the input task in the preceding example always runs before the output task, ensuring that valid data is always present at the output port.

In a Level-2 MATLAB S-function, use the `IsSpecialSampleHit` method to determine whether the current simulation time is one at which multiple tasks implemented by this block are active.

Specifying Model Reference Sample Time Inheritance

If your C MEX S-function inherits its sample times from the blocks that drive it, your S-function should specify whether submodels containing your S-function can inherit sample times from their parent model. If the S-function output does not depend on its inherited sample time, use the `ssSetModelReferenceSampleTimeInheritanceRule` macro to set the S-function sample time inheritance rule to `USE_DEFAULT_FOR_DISCRETE_INHERITANCE`. Otherwise, set the rule to `DISALLOW_SAMPLE_TIME_INHERITANCE` to disallow sample-time inheritance for submodels that include S-functions whose outputs depend on their inherited sample time and thereby avoid inadvertent simulation errors.

Note If your S-function does not set this flag, the Simulink engine assumes that it does not preclude a submodel containing it from inheriting a sample time. However, the engine optionally warns you that the submodel contains S-functions that do not specify a sample-time inheritance rule (see “Blocks Whose Outputs Depend on Inherited Sample Time” in *Using Simulink*).

If you are uncertain whether an existing S-function output depends on its inherited sample time, check whether it invokes any of the following C macros:

- `ssGetSampleTime`
- `ssGetInputPortSampleTime`
- `ssGetOutputPortSampleTime`
- `ssGetInputPortOffsetTime`
- `ssGetOutputPortOffsetTime`
- `ssGetSampleTimePtr`
- `ssGetInputPortSampleTimeIndex`
- `ssGetOutputPortSampleTimeIndex`
- `ssGetSampleTimeTaskID`
- `ssGetSampleTimeTaskIDPtr`

or TLC functions:

- `LibBlockSampleTime`
- `CompiledModel.SampleTime`
- `LibBlockInputSignalSampleTime`
- `LibBlockInputSignalOffsetTime`
- `LibBlockOutputSignalSampleTime`
- `LibBlockOutputSignalOffsetTime`

If your S-function does not invoke any of these macros or functions, its output does not depend on its inherited sample time and hence it is safe to use in submodels that inherit their sample time.

Sample-Time Inheritance Rule Example

As an example of an S-function that precludes a submodel from inheriting its sample time, consider an S-function that has the following `mdlOutputs` method:

```
static void mdlOutputs(SimStruct *S, int_T tid) {
    const real_T *u = (const real_T*)
        ssGetInputPortSignal(S,0);
    real_T *y = ssGetOutputPortSignal(S,0);
    y[0] = ssGetSampleTime(S,tid) * u[0];
}
```

The output of this S-function is its inherited sample time, hence its output depends on its inherited sample time, and hence it is unsafe to use in a submodel. For this reason, this S-function should specify its model reference inheritance rule as follows:

```
ssSetModelReferenceSampleTimeInheritanceRule
(S, DISALLOW_SAMPLE_TIME_INHERITANCE);
```

Zero Crossings

S-functions model zero crossings using the mode work vector (or a DWork vector configured as a mode vector) and the continuous zero-crossing vector. Whether the S-function uses mode or DWork vectors, the concept and implementation are the same. For an example using DWork vectors to model zero crossings, see “DWork Mode Vector” on page 7-21 in the “Using Work Vectors” section. The remainder of this section uses mode vectors to model zero crossings.

Note Level-2 MATLAB S-functions do not support zero-crossing detection. The remainder of this section pertains only to C MEX S-functions.

Elements of the mode vector are integer values. You specify the number of mode vector elements in `mdlInitializeSizes`, using `ssSetNumModes(S,num)`. You can then access the mode vector using `ssGetModeVector`. The mode vector values determine how the `mdlOutputs` routine operates when the solvers are homing in on zero crossings. The Simulink solvers track the zero crossings or state events (i.e., discontinuities in the first derivatives) of some signal, usually a function of an input to your S-function, by looking at the continuous zero crossings. Register the number of continuous zero crossings in `mdlInitializeSizes`, using `ssSetNumNonsampledZCs(S, num)`, then include an `mdlZeroCrossings` routine to calculate the continuous zero crossings. The S-function `sfun_zc_sat.c` contains a zero-crossing example. The remainder of this section describes the portions of this S-function that pertain to zero-crossing detection. For a full description of this example, see “Zero-Crossing Detection” on page 8-111.

First, `mdlInitializeSizes` specifies the sizes for the mode and continuous zero-crossing vectors using the following lines of code.

```
ssSetNumModes(S, DYNAMICALLY_SIZED);  
ssSetNumNonsampledZCs(S, DYNAMICALLY_SIZED);
```

Since the number of modes and continuous zero crossings is dynamically sized, `mdlSetWorkWidths` must initialize the actual size of these vectors. In this example, shown below, there is one mode vector for each output element and two continuous zero crossings for each mode. In general, the number of

continuous zero crossings needed for each mode depends on the number of events that need to be detected. In this case, each output (mode) needs to detect when it hits the upper or the lower bound, hence two continuous zero crossings per mode.

```
static void mdlSetWorkWidths(SimStruct *S)
{
    int nModes;
    int nNonsampledZCs;

    nModes          = numOutput;
    nNonsampledZCs = 2 * numOutput;

    ssSetNumModes(S,nModes);
    ssSetNumNonsampledZCs(S,nNonsampledZCs);
}
```

Next, `mdlOutputs` determines which mode the simulation is running in at the beginning of each major time step. The method stores this information in the mode vector so it is available when calculating outputs at both major and minor time steps.

```
/* Get the mode vector */
int_T *mode = ssGetModeVector(S);

/* Specify three possible mode values.*/
enum { UpperLimitEquation, NonLimitEquation, LowerLimitEquation };

/* Update the mode vector at the beginning of a major time step */
if ( ssIsMajorTimeStep(S) ) {
    for ( iOutput = 0; iOutput < numOutput; iOutput++ ) {
        if ( *uPtrs[uIdx] > *upperLimit ) {
            /* Upper limit is reached. */
            mode[iOutput] = UpperLimitEquation;

        } else if ( *uPtrs[uIdx] < *lowerLimit ) {
            /* Lower limit is reached. */
            mode[iOutput] = LowerLimitEquation;

        } else {
            /* Output is not limited. */

```

```

        mode[iOutput] = NonLimitEquation;
    }

    /* Adjust indices to give scalar expansion. */
    uIdx      += uInc;
    upperLimit += upperLimitInc;
    lowerLimit += lowerLimitInc;
}
/* Reset index to input and limits. */
uIdx      = 0;
upperLimit = mxGetPr( P_PAR_UPPER_LIMIT );
lowerLimit = mxGetPr( P_PAR_LOWER_LIMIT );

} /* end IsMajorTimeStep */

```

Output calculations in `mdlOutputs` are done based on the values stored in the mode vector.

```

for ( iOutput = 0; iOutput < numOutput; iOutput++ ) {
    if ( mode[iOutput] == UpperLimitEquation ) {
        /* Output upper limit. */
        *y++ = *upperLimit;

    } else if ( mode[iOutput] == LowerLimitEquation ) {
        /* Output lower limit. */
        *y++ = *lowerLimit;

    } else {
        /* Output is equal to input */
        *y++ = *uPtrs[uIdx];
    }
}

```

After outputs are calculated, the Simulink engine calls `mdlZeroCrossings` to determine if a zero crossing has occurred. A zero crossing is detected if any element of the continuous zero-crossing vector switches from negative to positive, or positive to negative. If this occurs, the simulation modifies the step size and recalculates the outputs to try to locate the exact zero crossing. For this example, the values for the continuous zero-crossing vectors are calculated as shown below.

```
static void mdlZeroCrossings(SimStruct *S)
{
    int_T          iOutput;
    int_T          numOutput = ssGetOutputPortWidth(S,0);
    real_T         *zcSignals = ssGetNonsampledZCs(S);
    InputRealPtrsType uPtrs    = ssGetInputPortRealSignalPtrs(S,0);

    /* Set index and increment for the input signal, upper limit, and lower
     * limit parameters so that each gives scalar expansion if needed. */
    int_T uIdx      = 0;
    int_T uInc      = ( ssGetInputPortWidth(S,0) > 1 );
    const real_T *upperLimit = mxGetPr( P_PAR_UPPER_LIMIT );
    int_T upperLimitInc = ( mxGetNumberOfElements( P_PAR_UPPER_LIMIT ) > 1 );
    const real_T *lowerLimit = mxGetPr( P_PAR_LOWER_LIMIT );
    int_T lowerLimitInc = ( mxGetNumberOfElements( P_PAR_LOWER_LIMIT ) > 1 );

    /*Check if the input has crossed an upper or lower limit */
    for ( iOutput = 0; iOutput < numOutput; iOutput++ ) {
        zcSignals[2*iOutput] = *uPtrs[uIdx] - *upperLimit;
        zcSignals[2*iOutput+1] = *uPtrs[uIdx] - *lowerLimit;

        /* Adjust indices to give scalar expansion if needed */
        uIdx      += uInc;
        upperLimit += upperLimitInc;
        lowerLimit += lowerLimitInc;
    }
}
```

S-Function Compliance with the SimState

In this section...

“SimState Compliance Specification for Level-2 MATLAB S-Functions” on page 8-54

“SimState Compliance Specification for C-MEX S-Functions” on page 8-55

SimState Compliance Specification for Level-2 MATLAB S-Functions

In order for a Level-2 MATLAB S-function to work with the SimState feature, you must specify the `simStateCompliance` of the block using the method,

```
block.simStateCompliance = setting
```

where the permissible setting values are:

Setting	Result
'UnknownSimState'	This default setting instructs Simulink to use the <code>DefaultSimState</code> to save and restore the <code>SimState</code> and issues a warning.
'DefaultSimState'	This setting instructs Simulink to treat the S-function like a built-in block when saving and restoring the <code>SimState</code> .
'HasNoSimState'	This setting informs Simulink that the S-function does not have any simulation state. With this setting, no state information is saved for the block. This setting is primarily useful for "sink" blocks (i.e., blocks with no output ports) that use <code>PWorks</code> or <code>DWorks</code> to store handles to files or figure windows.
'CustomSimState'	This setting informs Simulink that the S-function has custom <code>GetSimState</code> and <code>SetSimState</code> methods.
'DisallowSimState'	This setting informs Simulink that the S-function does not allow saving or restoring its simulation state. Simulink reports an error if you save and restore the <code>SimState</code> of the model that contains this S-function.

For an S-function with custom methods ('`CustomSimState`'), you can use the following statements to respectively get and set the `SimState`:

```
function outSS = GetSimState(block)  
function SetSimState(block, inSS)
```

For an example of how to implement these custom methods, see `msfcn_varpulse.m`.

SimState Compliance Specification for C-MEX S-Functions

As with the MATLAB S-function, your C-MEX S-function code must inform Simulink of the S-function compliance with the SimState feature. You can accomplish this task by using the S-function API, `ssSetSimStateCompliance`.

In most cases, you must add only the following line:

```
ssSetSimStateCompliance(S, USE_DEFAULT_SIM_STATE).
```

The options are as follows:

Setting	Result
<code>SIM_STATE_COMPLIANCE_UNKNOWN</code>	This is the default setting for all S-functions. For S-functions that do not use PWorks, Simulink saves and restores the default simulation state (see next option) and issues a warning to inform the user of this assumption. On the other hand, Simulink reports an error during the save and restore if it encounters an S-function that uses PWorks.
<code>USE_DEFAULT_SIM_STATE</code>	This setting instructs Simulink to treat the S-function like a built-in block when saving and restoring the <code>SimState</code> .
<code>HAS_NO_SIM_STATE</code>	This setting informs Simulink that the S-function does not have any simulation state. With this setting, no state information is saved for this block. This setting is primarily useful for "sink" blocks (i.e., blocks with no output ports) that use PWorks or DWorks to store handles to files or figure windows.
<code>DISALLOW_SIM_STATE</code>	This setting informs Simulink that the S-function does not allow the saving or restoring of its simulation state. Simulink reports an error if you save and restore the <code>SimState</code> of the model that contains this S-function.
<code>USE_CUSTOM_SIM_STATE</code>	This setting informs Simulink that the S-function has <code>mdlGetSimState</code> and <code>mdlSetSimState</code> methods.

For S-functions that use PWork vectors or static variables to hold data that Simulink updates during simulation, the S-function must use the custom `mdlGetSimState` and `mdlSetSimState` methods. The following statements demonstrate the proper format.

```
mxArray* mdlGetSimState(SimStruct* S)
void mdlSetSimState(SimStruct* S, const mxArray* inSS)
```

For an example of how to implement these methods, see `sfun_simstate.c`.

Matrices in C S-Functions

In this section...

“MX Array Manipulation” on page 8-57

“Memory Allocation” on page 8-58

MX Array Manipulation

S-functions can manipulate `mxAArrays` using the standard MATLAB API functions. (See “C/C++ Matrix Library” for a list of functions.) In general, if your S-function is declared exception free by passing the `SS_OPTION_EXCEPTION_FREE_CODE` option to `ssSetOptions` (see Exception Free Code in “Error Handling” on page 8-69), it should avoid MATLAB API functions that throw exceptions (i.e., long jump), such as `mxCreateDoubleMatrix`. Otherwise, the S-function can use any of the listed functions.

If you have Simulink Coder, it supports a subset of the `mxAArray` manipulation functions when generating noninlined code for an S-function. For a list of supported functions, see “Write Noninlined S-Functions”.

Calls to the macro `ssGetSFcnParam` return a pointer to an `mxAArray`, which can be used with the `mxAArray` manipulation functions. If your S-function contains S-function parameters, use the `mxAArray` manipulation functions in the `mdlCheckParameters` method to check the S-function parameter values. See the S-function `sfun_runtime3.c` for an example

In this S-function, the following lines check that the first S-function parameter is a character array with a length greater than or equal to two.

```
if (!mxIsChar(ssGetSFcnParam(S, 0)) ||
    (nu=mxGetNumberOfElements(ssGetSFcnParam(S, 0)) < 2) {
    ssSetErrorStatus(S,"1st parameter to S-function must be a "
        "string of at least 2 '+' and '-' characters");
    return;
}
```

Memory Allocation

When you create an S-function, you might need to allocate memory for each instance of your S-function. The standard MATLAB API memory allocation routines `mxMalloc` and `mxFree` should not be used with C MEX S-functions, because these routines are designed to be used with MEX files that are called from the MATLAB environment and not the Simulink environment. The correct approach for allocating memory is to use the `stdlib.h` library routines `calloc` and `free`. In `mdlStart`, allocate and initialize the memory

```
UD *ptr = (UD *)calloc(1, sizeof(UD));
```

where `UD`, in this example, is a data structure defined at the beginning of the S-function. Then, place the pointer to it either in the pointer work vector

```
ssSetPWorkValue(S, 0, ptr);
```

or attach it as user data.

```
ssSetUserData(S, ptr);
```

In `mdlTerminate`, free the allocated memory. For example, if the pointer was stored in the user data

```
UD *prt = ssGetUserData(S);  
free(prt);
```

Function-Call Subsystems and S-Functions

You can create a triggered subsystem whose execution is determined by logic internal to a C MEX S-function instead of by the value of a signal. A subsystem so configured is called a *function-call subsystem*. You cannot trigger a function-call subsystem from a Level-2 MATLAB S-function. To implement a function-call subsystem:

- In the Trigger block, select **function-call** as the **Trigger type** parameter.
- In the S-function, use the `ssEnableSystemWithTid` and `ssDisableSystemWithTid` to enable or disable the triggered subsystem and the `ssCallSystemWithTid` macro to call the triggered subsystem.
- In the model, connect the S-Function block output directly to the trigger port.

Note Function-call connections can only be performed on the first output port.

Function-call subsystems are not executed directly by the Simulink engine; rather, the S-function determines when to execute the subsystem. When the subsystem completes execution, control returns to the S-function. This figure illustrates the interaction between a function-call subsystem and an S-function.

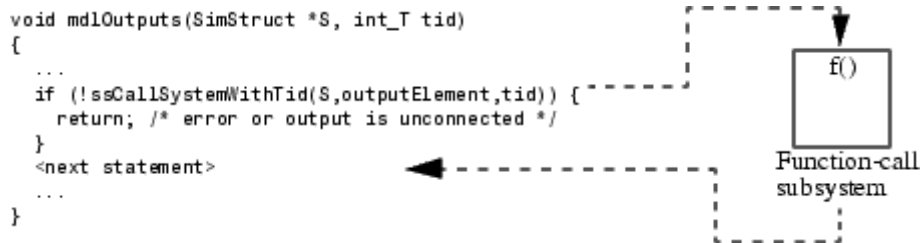

In this figure, `ssCallSystemWithTid` executes the function-call subsystem that is connected to the first output port element. `ssCallSystemWithTid` returns 0 if an error occurs while executing the function-call subsystem or if

the output is unconnected. After the function-call subsystem executes, control is returned to your S-function.

Function-call subsystems can only be connected to S-functions that have been properly configured to accept them.

To configure an S-function to call a function-call subsystem:

- Specify the elements that are to execute the function-call subsystem in `mdlInitializeSampleTimes`. For example:

```
ssSetCallSystemOutput(S,0); /* call on first element */
ssSetCallSystemOutput(S,1); /* call on second element */
```

- Specify in `mdlInitializeSampleTimes` whether you want the S-function to be able to enable or disable the function-call subsystem. Only S-functions that explicitly enable and disable the function-call subsystem can reset the states and outputs of the subsystem, as determined by the function-call subsystem's Trigger and Outport blocks. For example, the code

```
ssSetExplicitFCSSCtrl(S, 1);
```

in `mdlInitializeSampleTimes` specifies that the S-function can enable and disable the function-call subsystem. In this case, the S-function must invoke `ssEnableSystemWithTid` before executing the subsystem using `ssCallSystemWithTid`.

- Execute the subsystem in the appropriate `mdlOutputs` or `mdlUpdate` S-function routine. For example:

```
static void mdlOutputs(...)
{
    if (((int)*uPtrs[0]) % 2 == 1) {
        if (!ssCallSystemWithTid(S,0,tid)) {
            /* Error occurred, which will be reported by */
            /*the Simulink engine*/
            return;
        }
    } else {
        if (!ssCallSystemWithTid(S,1,tid)) {
            /* Error occurred, which will be reported by */
            /*the Simulink engine*/
            return;
        }
    }
    ...
}
```

Note Do not use `ssSetOutputPortDataType` or `ssGetOutputPortDataType` on an S-function output that emits function-call signals. The Simulink engine explicitly controls the data type of these output signals.

See `sfun_fcncall.c` for an example that executes a function-call subsystem on the first and second elements of the first S-function output. The following Simulink model (`sfcndemo_sfun_fcncall`) uses this S-function.

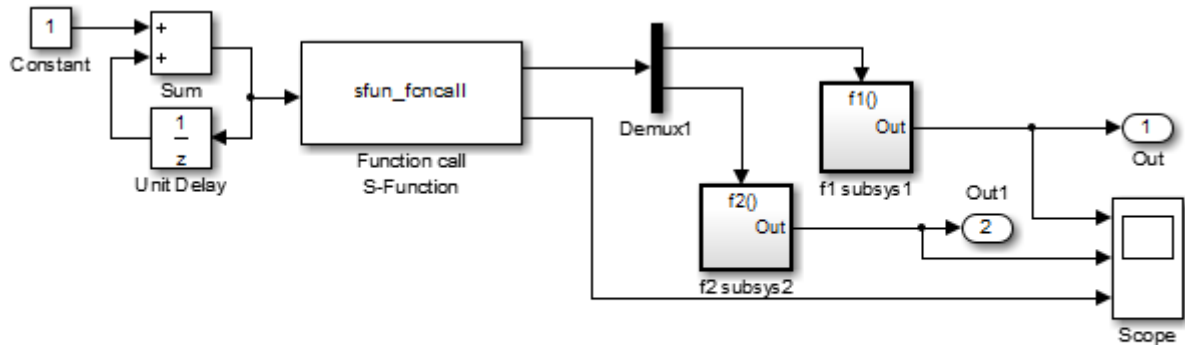

```
matlabroot\toolbox\simulink\simdemos\simfeatures\src\sfun_fncall.c
```

The first function-call subsystem provides a sine wave output. The second function-call subsystem is a simple feedback loop containing a Unit Delay block.

```
sfcndemo_sfun_fncall ▶ f1 subsystem
```

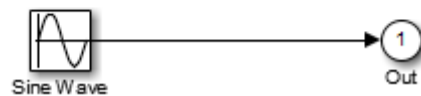

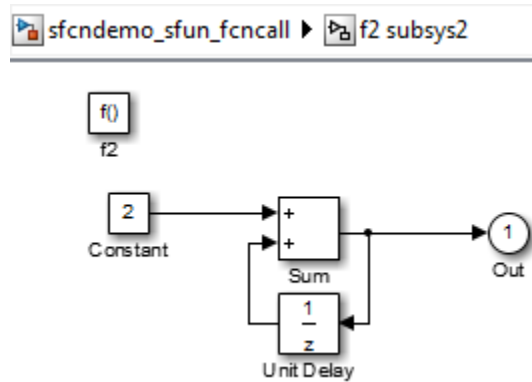

When the Pulse Generator emits its upper value, the function-call subsystem connected to the first element of the first S-function output port is triggered. Similarly, when the Pulse Generator emits its lower value, the function-call subsystem connected to the second element is triggered. The simulation output is shown on the following Scope.

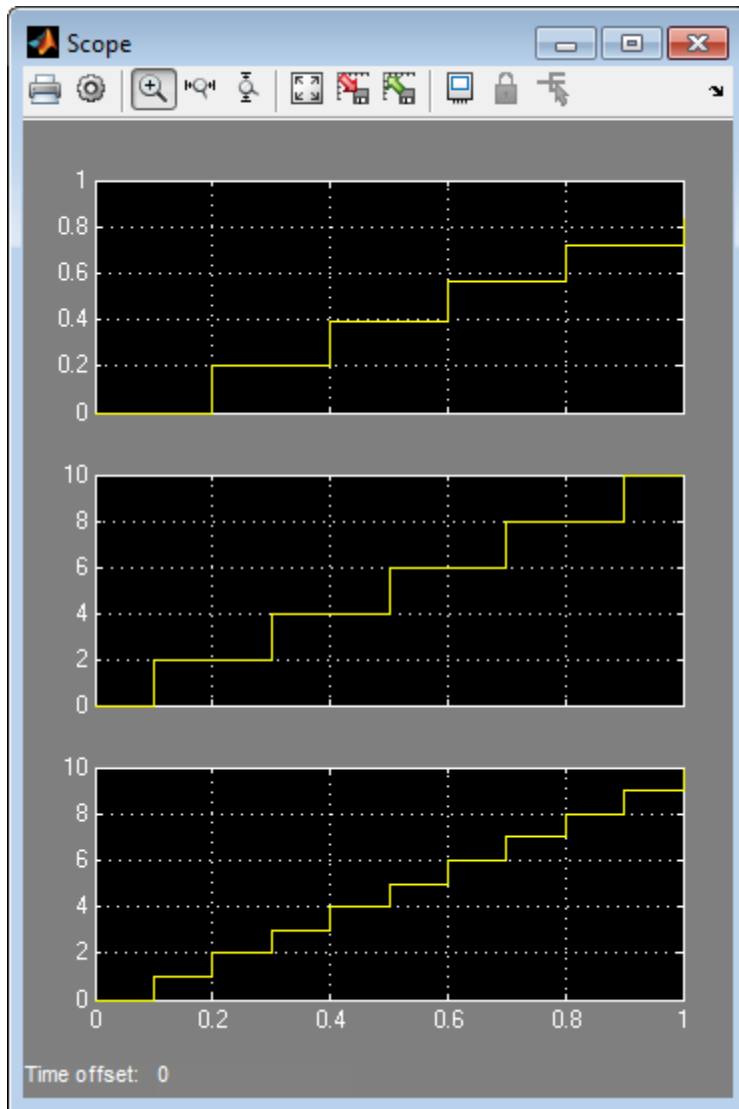

Function-call subsystems are a powerful modeling construct. You can configure Stateflow® blocks to execute function-call subsystems, thereby extending the capabilities of the blocks. For more information, see the Stateflow documentation.

Sim Viewing Devices in External Mode

A sim viewing device encapsulates processing and viewing of signals received from the target system in external mode. During simulation in external mode, the target system uploads the appropriate input values to the sim viewing device in the Simulink model. The sim viewing device then conditions the input signals as needed and renders the signals on the screen. A sim viewing device runs only on the host, generating no code in the target system and, therefore, allowing extra processing of displayed signals without burdening the generated code.

You can use your S-function as a sim viewing device in external mode if it satisfies the following conditions.

- The S-function has no output ports.
- The S-function contains no states.
- The generated code does not require the conditioned signals produced by the S-function.

To specify a C MEX S-function is a sim viewing device, set the `SS_OPTION_SIM_VIEWING_DEVICE` option in the `mdlInitializeSizes` function. For example

```
ssSetOptions(S, SS_OPTION_SIM_VIEWING_DEVICE);
```

To specify a Level-2 MATLAB S-function is a sim viewing device, call the run-time object's `SetSimViewingDevice` method in the S-function `setup` callback method.

External mode compatible S-functions are selected, and the trigger is armed, by using the External Signal & Triggering dialog box. For more information see “Host/Target Communication” in the Simulink Coder documentation.

Frame-Based Signals

In this section...

“About Frame-Based Signals” on page 8-66

“Using Frame-Based Signals in C S-Functions” on page 8-66

“Using Frame-Based Signals in Level-2 MATLAB S-Functions” on page 8-68

About Frame-Based Signals

This section explains how to create an S-function that accepts or produces frame-based signals. For more information, see “Sample- and Frame-Based Concepts” in the DSP System Toolbox™ documentation.

Note Simulating a model containing an S-function that accepts or produces frames requires a DSP System Toolbox product license.

Using Frame-Based Signals in C S-Functions

To accept or produce frame-based signals, a C MEX S-function must perform the following tasks:

- The S-function `mdlInitializeSizes` callback method must set the port frame status to `FRAME_YES`, `FRAME_NO`, or `FRAME_INHERITED` for each of the S-function I/O ports, using the `ssSetInputPortFrameData` and `ssSetOutputPortFrameData` functions. The frame status for a port must be set after the call to `ssSetNumInputPorts` and `ssSetNumOutputPorts`. For example, the following code in `mdlInitializeSizes` specifies that the first input port accepts a frame-based signal while the first output port emits a sample-based signal:

```
ssSetNumInputPorts(S, 1);  
ssSetInputPortFrameData(S, 0, FRAME_YES);  
ssSetNumOutputPorts(S, 1);  
ssSetOutputPortFrameData(S, 0, FRAME_NO);
```

- The S-function should specify the dimensions of the signals that its frame-based ports accept or produce in its `mdlInitializeSizes` or

`mdlSetInputPortDimensionInfo` and `mdlSetOutputPortDimensionInfo` callback methods. Note that frame-based signals must be dimensioned as 2-D arrays. For example, the following code in `mdlInitializeSizes` specifies that the first frame-based input port is dynamically sized. This S-function must then also have an `mdlSetInputPortDimensionInfo` callback that sets the specific dimensions of this input port.

```
ssSetNumInputPorts(S, 1);
ssSetInputPortFrameData(S, 0, FRAME_YES);
ssSetInputPortMatrixDimensions(S, 0, DYNAMICALLY_SIZED, DYNAMICALLY_SIZED);
```

- If the frame status of any of the S-function input ports is inherited, the S-function should define a `mdlSetInputPortFrameData` callback method. The Simulink engine passes the frame status that it assigns to the port, based on frame signal propagation rules, as an argument to this callback method. The callback method should in turn use the `ssSetInputPortFrameData` function to set the port to the assigned status if it is acceptable or signal an error using `ssSetErrorStatus` if it is not. If the frame status of other ports of the S-function depend on the status inherited by one of its input ports, the callback method can also use `ssSetInputPortFrameData` to set the frame status of the other ports based on the status that the input port inherits. A template for the `mdlSetInputPortFrameData` callback is shown below.

```
#if defined(MATLAB_MEX_FILE)
#define MDL_SET_INPUT_PORT_FRAME_DATA
static void mdlSetInputPortFrameData(SimStruct *S,
                                     int_T      portIndex,
                                     Frame_T    frameData)
{
    if(!frameData==FRAME_YES) {
        ssSetErrorStatus(S, "Incorrect frame status");
        return;
    }
    ssSetInputPortFrameData(S, portIndex, frameData); /* Sets frame status */
} /* end mdlSetInputPortFrameData */
#endif
```

- The S-function `mdlOutputs` method should include code to process the signals. The macro `ssGetInputPortDimensions` can be used in `mdlOutputs` to determine the dimensions of dynamically sized frame-based inputs, as follows:

```
int *dims    = ssGetInputPortDimensions(S, 0);
int frameSize = dims[0];
int numChannels = dims[1];
```

See the frame-based A/D converter S-function example (`sfun_frmad.c`) for an example of how to create a frame-based S-function. This S-function is one of several S-functions that manipulate frame-based signals found in the Simulink model `sfcndemo_frame`.

Using Frame-Based Signals in Level-2 MATLAB S-Functions

In a Level-2 MATLAB S-function, set the `SamplingMode` property of the port to indicate if the block accepts frame-based signals, for example:

```
block.InputPort(1).SamplingMode = 'Inherited';
```

If any of the ports inherited their sampling mode, define a `SetInputPortSamplingMode` callback method to specify the sampling mode.

Error Handling

In this section...

“About Handling Errors” on page 8-69

“Exception Free Code” on page 8-70

“ssSetErrorStatus Termination Criteria” on page 8-71

“Checking Array Bounds” on page 8-72

About Handling Errors

When working with S-functions, it is important to handle unexpected events such as invalid parameter values correctly.

If your C MEX S-function has parameters whose contents you need to validate, use the following technique to report errors.

```
ssSetErrorStatus(S,"Error encountered due to ...");  
return;
```

In most cases, the Simulink engine displays error messages in the Simulation Diagnostics Viewer. If the error is encountered in `mdlCheckParameters` as the S-function parameters are being entered into the block dialog, the engine opens the error dialog shown below. In either case, the engine displays the error message along with the name of the S-function and the associated S-function block that invoked the error.

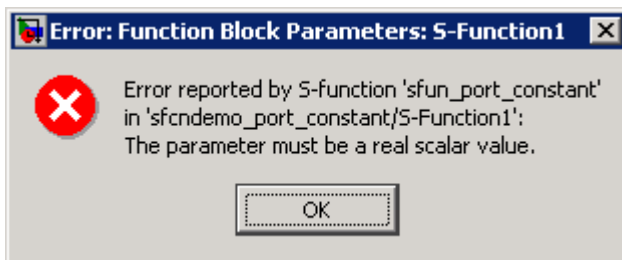

The second argument to `ssSetErrorStatus` must be persistent memory. It cannot be a local variable in your function. For example, the following causes unpredictable errors.

```
mdlOutputs()  
{  
    char msg[256]; /* ILLEGAL: should be "static char */  
                  /*msg[256];"*/  
    sprintf(msg,"Error due to %s", string);  
    ssSetErrorStatus(S,msg);  
    return;  
}
```

Because `ssSetErrorStatus` does not generate exceptions, using it to report errors in your S-function is preferable to using `mexErrMsgTxt`. The `mexErrMsgTxt` function uses exception handling to terminate S-function execution. To support exception handling in S-functions, the Simulink engine must set up exception handlers prior to each S-function invocation. This introduces overhead into simulation.

Exception Free Code

You can avoid simulation overhead by ensuring that your C MEX S-function contains entirely *exception free code*. Exception free code refers to code that never long-jumps. Your S-function is not exception free if it contains any routine that, when called, has the potential of long-jumping. For example, `mexErrMsgTxt` throws an exception (i.e., long-jumps) when called, thus ending execution of your S-function. Using `mxMalloc` can cause unpredictable results in the event of a memory allocation error, because `mxMalloc` long-jumps. If memory allocation is needed, use the `stdlib.h` `calloc` routine directly and perform your own error handling.

If you do not call `mexErrMsgTxt` or other API routines that cause exceptions, use the `SS_OPTION_EXCEPTION_FREE_CODE` S-function option. You do this by issuing the following command in the `mdlInitializeSizes` function.

```
ssSetOptions(S, SS_OPTION_EXCEPTION_FREE_CODE);
```

Setting this option increases the performance of your S-function by allowing the Simulink engine to bypass the exception-handling setup

that is usually performed prior to each S-function invocation. You must take extreme care to verify that your code is exception free when using `SS_OPTION_EXCEPTION_FREE_CODE`. If your S-function generates an exception when this option is set, unpredictable results occur.

All `mex*` routines have the potential of long-jumping. Several `mex*` routines also have the potential of long-jumping. To avoid any difficulties, use only the API routines that retrieve a pointer or determine the size of parameters. For example, the following API routines never throw an exception: `mxGetPr`, `mxGetData`, `mxGetNumberOfDimensions`, `mxGetM`, `mxGetN`, and `mxGetNumberOfElements`.

Code in *run-time routines* can also throw exceptions. Run-time routines refer to certain S-function routines that the engine calls during the simulation loop (see “Simulink Engine Interaction with C S-Functions” on page 4-76). The run-time routines include

- `mdlGetTimeOfNextVarHit`
- `mdlOutputs`
- `mdlUpdate`
- `mdlDerivatives`

If all run-time routines within your S-function are exception free, you can use this option:

```
ssSetOptions(S, SS_OPTION_RUNTIME_EXCEPTION_FREE_CODE);
```

The other routines in your S-function do not have to be exception free.

ssSetErrorStatus Termination Criteria

If one of your C MEX S-function callback methods invokes `ssSetErrorStatus` during a simulation, the Simulink engine posts the error and terminates the simulation as soon as the callback method returns. If your S-function `SS_OPTION_CALL_TERMINATE_ON_EXIT` option is enabled (see `ssSetOptions`), The engine invokes your S-function `mdlTerminate` method as part of the termination process. Otherwise, the engine invokes your S-function `mdlTerminate` method only if at least one block `mdlStart` method has executed without error during the simulation.

Checking Array Bounds

If your C MEX S-function causes otherwise inexplicable errors, the reason might be that the S-function is writing beyond its assigned areas in memory. You can verify this possibility by enabling the array bounds checking feature. This feature detects any attempt by an S-Function block to write beyond the areas assigned to it for the following types of block data:

- Work vectors (R, I, P, D, and mode)
- States (continuous and discrete)
- Outputs

To enable array bounds checking, select **warning** or **error** from the **Array bounds exceeded** options list in the **Debugging** group on the **Diagnostics - Data Validity** pane of the **Configuration Parameters** dialog box or enter the following command at the MATLAB command prompt.

```
set_param(modeName, 'ArrayBoundsChecking', ValueStr)
```

where *modeName* is the name of the Simulink model and *ValueStr* is either 'none', 'warning', or 'error'.

C MEX S-Function Examples

In this section...

“About S-Function Examples” on page 8-73

“Continuous States” on page 8-73

“Discrete States” on page 8-80

“Continuous and Discrete States” on page 8-86

“Variable Sample Time” on page 8-94

“Array Inputs and Outputs” on page 8-100

“Zero-Crossing Detection” on page 8-111

“Discontinuities in Continuous States” on page 8-129

About S-Function Examples

All examples are based on the C MEX S-function templates `sfuntmpl_basic.c` and `sfuntmpl_doc.c`. Open `sfuntmpl_doc.c` for a detailed discussion of the S-function template.

Continuous States

The `csfunc.c` example shows how to model a continuous system with states using a C MEX S-function. The following Simulink model uses this S-function.

`sfcdemo_csfunc`

In continuous state integration, the Simulink solvers integrate a set of continuous states using the following equations.

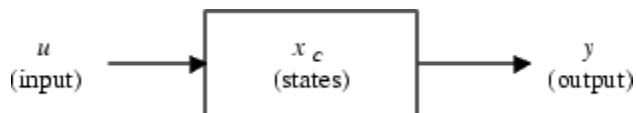

$$y = f_0(t, x_c, u) \quad (\text{output})$$

$$\dot{x}_c = f_d(t, x_c, u) \quad (\text{derivative})$$

S-functions that contain continuous states implement a state-space equation. The `mdlOutputs` method contains the output portion and `mdlDerivatives` method contains the derivative portion of the state-space equation. To visualize how the integration works, see the flowchart in “Simulink Engine Interaction with C S-Functions” on page 4-76. The output equation corresponds to the `mdlOutputs` in the major time step. Next, the example enters the integration section of the flowchart. Here the Simulink engine performs a number of minor time steps during which it calls `mdlOutputs` and `mdlDerivatives`. Each of these pairs of calls is referred to as an *integration stage*. The integration returns with the continuous states updated and the simulation time moved forward. Time is moved forward as far as possible, providing that error tolerances in the state are met. The maximum time step is subject to constraints of discrete events such as the actual simulation stop time and the user-imposed limit.

The `csfunc.c` example specifies that the input port has direct feedthrough. This is because matrix `D` is initialized to a nonzero matrix. If `D` is set equal to a zero matrix in the state-space representation, the input signal is not used in `mdlOutputs`. In this case, the direct feedthrough can be set to 0, which indicates that `csfunc.c` does not require the input signal when executing `mdlOutputs`.

matlabroot/simulink/src/csfunc.c

The S-function begins with `#define` statements for the S-function name and level, and a `#include` statement for the `simstruc.h` header. After these statements, the S-function can include or define any other necessary headers, data, etc. The `csfunc.c` example defines the variable `U` as a pointer to the first input port's signal and initializes static variables for the state-space matrices.

```
/* File      : csfunc.c
 * Abstract:
 *
 *      Example C S-function for defining a continuous system.
 *
 *      x' = Ax + Bu
 *      y  = Cx + Du
 *
 *      For more details about S-functions, see simulink/src/sfuntmpl_doc.c.
 *
```

```

* Copyright 1990-2007 The MathWorks, Inc.
*/

#define S_FUNCTION_NAME csfunc
#define S_FUNCTION_LEVEL 2

#include "simstruc.h"

#define U(element) (*uPtrs[element]) /* Pointer to Input Port0 */

static real_T A[2][2]={ { -0.09, -0.01 } ,
                        { 1 , 0 }
                        };

static real_T B[2][2]={ { 1 , -7 } ,
                        { 0 , -2 }
                        };

static real_T C[2][2]={ { 0 , 2 } ,
                        { 1 , -5 }
                        };

static real_T D[2][2]={ { -3 , 0 } ,
                        { 1 , 0 }
                        };

```

The required S-function method `mdlInitializeSizes` then sets up the following S-function characteristics.

- `ssSetNumSFcnParams` sets the number of expected S-function dialog parameters to zero.
- `ssGetSFcnParamsCount` determines how many parameters the user actually entered into the S-function dialog. If the number of user-specified parameters does not match the number returned by `ssGetNumSFcnParams`, the S-function errors out.
- If the S-function parameter count passes, `mdlInitializeSizes` sets the number of continuous and discrete states using `ssSetNumContStates` and `ssSetNumDiscStates`, respectively. This example has two continuous states and zero discrete states.

- Next, the method configures the S-function to have a single input and output port, each with a width of two to match the dimensions of the state-space matrices. The method passes a value of 1 to `ssSetInputPortDirectFeedThrough` to indicate the input port has direct feedthrough.
- `ssSetNumSampleTimes` initializes one sample time, which the `mdlInitializeSampleTimes` function configures later.
- The S-function indicates that no work vectors are used by passing a value of 0 to `ssSetNumRWork`, `ssSetNumIWork`, etc. You can omit these lines because zero is the default value for all of these macros. However, for clarity, the S-function explicitly sets the number of work vectors.
- Lastly, `ssSetOptions` sets any applicable options. In this case, the only option is `SS_OPTION_EXCEPTION_FREE_CODE`, which stipulates that the code is exception free.

The `mdlInitializeSizes` function for this example is shown below.

```
/*=====*
 * S-function methods *
 *=====*/

/* Function: mdlInitializeSizes =====
 * Abstract:
 *   Determine the S-function block's characteristics:
 *   number of inputs, outputs, states, etc.
 */
static void mdlInitializeSizes(SimStruct *S)
{
    ssSetNumSFcnParams(S, 0); /* Number of expected parameters */
    if (ssGetNumSFcnParams(S) != ssGetSFcnParamsCount(S)) {
        return; /* Parameter mismatch reported by the Simulink engine*/
    }

    ssSetNumContStates(S, 2);
    ssSetNumDiscStates(S, 0);

    if (!ssSetNumInputPorts(S, 1)) return;
    ssSetInputPortWidth(S, 0, 2);
    ssSetInputPortDirectFeedThrough(S, 0, 1);
}
```

```

    if (!ssSetNumOutputPorts(S, 1)) return;
    ssSetOutputPortWidth(S, 0, 2);

    ssSetNumSampleTimes(S, 1);
    ssSetNumRWork(S, 0);
    ssSetNumIWork(S, 0);
    ssSetNumPWork(S, 0);
    ssSetNumModes(S, 0);
    ssSetNumNonsampledZCs(S, 0);

    /* Take care when specifying exception free code - see sfuntmpl_doc.c */
    ssSetOptions(S, SS_OPTION_EXCEPTION_FREE_CODE);
}

```

The required S-function method `mdlInitializeSampleTimes` specifies the S-function sample rates. The value `CONTINUOUS_SAMPLE_TIME` passed to the `ssSetSampleTime` macro specifies that the first S-function sample rate be continuous. `ssSetOffsetTime` then specifies an offset time of zero for this sample rate. The call to `ssSetModelReferenceSampleTimeDefaultInheritance` tells the solver to use the default rule to determine if submodels containing this S-function can inherit their sample times from the parent model.

```

/* Function: mdlInitializeSampleTimes =====
 * Abstract:
 *   Specify that we have a continuous sample time.
 */
static void mdlInitializeSampleTimes(SimStruct *S)
{
    ssSetSampleTime(S, 0, CONTINUOUS_SAMPLE_TIME);
    ssSetOffsetTime(S, 0, 0.0);
    ssSetModelReferenceSampleTimeDefaultInheritance(S);
}

```

The optional S-function method `mdlInitializeConditions` initializes the continuous state vector. The `#define` statement before this method is required for the Simulink engine to call this function. In the example below, `ssGetContStates` obtains a pointer to the continuous state vector. The `for` loop then initializes each state to zero.

```

#define MDL_INITIALIZE_CONDITIONS
/* Function: mdlInitializeConditions =====
 * Abstract:
 *   Initialize both continuous states to zero.
 */
static void mdlInitializeConditions(SimStruct *S)
{
    real_T *x0 = ssGetContStates(S);
    int_T lp;

    for (lp=0;lp<2;lp++) {
        *x0++=0.0;
    }
}

```

The required `mdlOutputs` function computes the output signal of this S-function. The beginning of the function obtains pointers to the first output port, continuous states, and first input port. The S-function uses the data in these arrays to solve the output equation $y=Cx+Du$.

```

/* Function: mdlOutputs =====
 * Abstract:
 *    $y = Cx + Du$ 
 */
static void mdlOutputs(SimStruct *S, int_T tid)
{
    real_T *y = ssGetOutputPortRealSignal(S,0);
    real_T *x = ssGetContStates(S);
    InputRealPtrsType uPtrs = ssGetInputPortRealSignalPtrs(S,0);

    UNUSED_ARG(tid); /* not used in single tasking mode */

    /*  $y=Cx+Du$  */
    y[0]=C[0][0]*x[0]+C[0][1]*x[1]+D[0][0]*u(0)+D[0][1]*u(1);
    y[1]=C[1][0]*x[0]+C[1][1]*x[1]+D[1][0]*u(0)+D[1][1]*u(1);
}

```

The `mdlDerivatives` function calculates the continuous state derivatives. Because this function is an optional method, a `#define` statement must precede the function. The beginning of the function obtains pointers to the

S-function continuous states, state derivatives, and first input port. The S-function uses this data to solve the equation $\dot{x}=Ax+Bu$.

```
#define MDL_DERIVATIVES
/* Function: mdlDerivatives =====
 * Abstract:
 *      xdot = Ax + Bu
 */
static void mdlDerivatives(SimStruct *S)
{
    real_T      *dx   = ssGetdX(S);
    real_T      *x    = ssGetContStates(S);
    InputRealPtrsType uPtrs = ssGetInputPortRealSignalPtrs(S,0);

    /* xdot=Ax+Bu */
    dx[0]=A[0][0]*x[0]+A[0][1]*x[1]+B[0][0]*U(0)+B[0][1]*U(1);
    dx[1]=A[1][0]*x[0]+A[1][1]*x[1]+B[1][0]*U(0)+B[1][1]*U(1);
}

```

The required `mdlTerminate` function performs any actions, such as freeing memory, necessary at the end of the simulation. In this example, the function is empty.

```
/* Function: mdlTerminate =====
 * Abstract:
 *      No termination needed, but we are required to have this routine.
 */
static void mdlTerminate(SimStruct *S)
{
    UNUSED_ARG(S); /* unused input argument */
}

```

The required S-function trailer includes the files necessary for simulation or code generation, as follows.

```
#ifdef MATLAB_MEX_FILE /* Is this file being compiled as a MEX file? */
#include "simulink.c" /* MEX file interface mechanism */
#else
#include "cg_sfun.h" /* Code generation registration function */
#endif

```

Note The `mdlOutputs` and `mdlTerminate` functions use the `UNUSED_ARG` macro to indicate that an input argument the callback requires is not used. This optional macro is defined in `simstruc_types.h`. If used, you must call this macro once for each input argument that a callback does not use.

Discrete States

The `dsfunc.c` example shows how to model a discrete system in a C MEX S-function. The following Simulink model uses this S-function.

`sfcndemo_dsfunc`

Discrete systems can be modeled by the following set of equations.

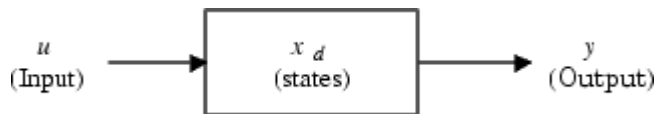

$$y = f_0(t, x_d, u) \quad (\text{Output})$$

$$x_{d+1} = f_u(t, x_d, u) \quad (\text{Update})$$

The `dsfunc.c` example implements a discrete state-space equation. The `mdlOutputs` method contains the output portion and the `mdlUpdate` method contains the update portion of the discrete state-space equation. To visualize how the simulation works, see the flowchart in “Simulink Engine Interaction with C S-Functions” on page 4-76. The output equation above corresponds to the `mdlOutputs` in the major time step. The preceding update equation corresponds to the `mdlUpdate` in the major time step. If your model does not contain continuous elements, the Simulink engine skips the integration phase and time is moved forward to the next discrete sample hit.

matlabroot/simulink/src/dsfunc.c

The S-function begins with `#define` statements for the S-function name and level, along with a `#include` statement for the `simstruc.h` header. After these statements, the S-function can include or define any other necessary

headers, data, etc. The `dsfunc.c` example defines `U` as a pointer to the first input port's signal and initializes static variables for the state-space matrices.

```

/* File   : dsfunc.c
 * Abstract:
 *
 *      Example C S-function for defining a discrete system.
 *
 *       $x(n+1) = Ax(n) + Bu(n)$ 
 *       $y(n) = Cx(n) + Du(n)$ 
 *
 *      For more details about S-functions, see simulink/src/sfuntmpl_doc.c.
 *
 *      Copyright 1990-2007 The MathWorks, Inc.
 */

#define S_FUNCTION_NAME dsfunc
#define S_FUNCTION_LEVEL 2

#include "simstruc.h"

#define U(element) (*uPtrs[element]) /* Pointer to Input Port0 */

static real_T A[2][2]={ { -1.3839, -0.5097 } ,
                        { 1      , 0      }
                      };

static real_T B[2][2]={ { -2.5559, 0      } ,
                        { 0      , 4.2382 }
                      };

static real_T C[2][2]={ { 0      , 2.0761 } ,
                        { 0      , 7.7891 }
                      };

static real_T D[2][2]={ { -0.8141, -2.9334 } ,
                        { 1.2426, 0      }
                      };

```

The required S-function method `mdlInitializeSizes` then sets up the following S-function characteristics.

- `ssSetNumSFcnParams` sets the number of expected S-function dialog parameters to zero.
- `ssGetSFcnParamsCount` determines how many parameters the user actually entered into the S-function dialog. If the number of user-specified parameters does not match the number returned by `ssGetNumSFcnParams`, the S-function errors out.
- If the S-function parameter count passes, `mdlInitializeSizes` next sets the number of continuous and discrete states using `ssSetNumContStates` and `ssSetNumDiscStates`, respectively. This example has zero continuous states and two discrete states.
- Next, the method configures the S-function to have a single input and output port, each with a width of two to match the dimensions of the state-space matrices. The method passes a value of 1 to `ssSetInputPortDirectFeedThrough` to indicate the input port has direct feedthrough.
- `ssSetNumSampleTimes` initializes one sample time, which the `mdlInitializeSampleTimes` function configures later.
- The S-function indicates that no work vectors are used by passing a value of 0 to `ssSetNumRWork`, `ssSetNumIWork`, etc. You can omit these lines because zero is the default value for all of these macros. However, for clarity, the S-function explicitly sets the number of work vectors.
- Lastly, `ssSetOptions` sets any applicable options. In this case, the only option is `SS_OPTION_EXCEPTION_FREE_CODE`, which stipulates that the code is exception free.

The `mdlInitializeSizes` function for this example is shown below.

```
/*=====*\n * S-function methods *\n *=====*/\n\n/* Function: mdlInitializeSizes =====\n * Abstract:\n *   Determine the S-function block's characteristics:
```

```

*    number of inputs, outputs, states, etc.
*/
static void mdlInitializeSizes(SimStruct *S)
{
    ssSetNumSFcnParams(S, 0); /* Number of expected parameters */
    if (ssGetNumSFcnParams(S) != ssGetSFcnParamsCount(S)) {
        return; /* Parameter mismatch reported by the Simulink engine*/
    }

    ssSetNumContStates(S, 0);
    ssSetNumDiscStates(S, 2);

    if (!ssSetNumInputPorts(S, 1)) return;
    ssSetInputPortWidth(S, 0, 2);
    ssSetInputPortDirectFeedThrough(S, 0, 1);

    if (!ssSetNumOutputPorts(S, 1)) return;
    ssSetOutputPortWidth(S, 0, 2);

    ssSetNumSampleTimes(S, 1);
    ssSetNumRWork(S, 0);
    ssSetNumIWork(S, 0);
    ssSetNumPWork(S, 0);
    ssSetNumModes(S, 0);
    ssSetNumNonsampledZCs(S, 0);

    /* Take care when specifying exception free code - see sfuntmpl_doc.c */
    ssSetOptions(S, SS_OPTION_EXCEPTION_FREE_CODE);
}

```

The required S-function method `mdlInitializeSampleTimes` specifies the S-function sample rates. A call to `ssSetSampleTime` sets this first S-function sample period to 1.0. `ssSetOffsetTime` then specifies an offset time of zero for the first sample rate. The call to `ssSetModelReferenceSampleTimeDefaultInheritance` tells the solver to use the default rule to determine if submodels containing this S-function can inherit their sample times from the parent model.

```

/* Function: mdlInitializeSampleTimes =====
* Abstract:

```

```
*   Specify a sample time of 1.0.
*/
static void mdlInitializeSampleTimes(SimStruct *S)
{
    ssSetSampleTime(S, 0, 1.0);
    ssSetOffsetTime(S, 0, 0.0);
    ssSetModelReferenceSampleTimeDefaultInheritance(S);
}
```

The optional S-function method `mdlInitializeConditions` initializes the discrete state vector. The `#define` statement before this method is required for the Simulink engine to call this function. In the example below, `ssGetRealDiscStates` obtains a pointer to the discrete state vector. The `for` loop then initializes each discrete state to one.

```
#define MDL_INITIALIZE_CONDITIONS
/* Function: mdlInitializeConditions =====
 * Abstract:
 *   Initialize both discrete states to one.
 */
static void mdlInitializeConditions(SimStruct *S)
{
    real_T *x0 = ssGetRealDiscStates(S);
    int_T lp;

    for (lp=0;lp<2;lp++) {
        *x0++=1.0;
    }
}
```

The required `mdlOutputs` function computes the output signal of this S-function. The beginning of the function obtains pointers to the first output port, discrete states, and first input port. The S-function uses the data in these arrays to solve the output equation $y=Cx+Du$.

```
/* Function: mdlOutputs =====
 * Abstract:
 *   y = Cx + Du
 */
static void mdlOutputs(SimStruct *S, int_T tid)
```

```

{
    real_T          *y    = ssGetOutputPortRealSignal(S,0);
    real_T          *x    = ssGetRealDiscStates(S);
    InputRealPtrsType uPtrs = ssGetInputPortRealSignalPtrs(S,0);

    UNUSED_ARG(tid); /* not used in single tasking mode */

    /* y=Cx+Du */
    y[0]=C[0][0]*x[0]+C[0][1]*x[1]+D[0][0]*U(0)+D[0][1]*U(1);
    y[1]=C[1][0]*x[0]+C[1][1]*x[1]+D[1][0]*U(0)+D[1][1]*U(1);
}

```

The Simulink engine calls the `mdlUpdate` function once every major integration time step to update the discrete states' values. Because this function is an optional method, a `#define` statement must precede the function. The beginning of the function obtains pointers to the S-function discrete states and first input port. The S-function uses the data in these arrays to solve the equation $dx=Ax+Bu$, which is stored in the temporary variable `tempX` before being assigned into the discrete state vector `x`.

```

#define MDL_UPDATE
/* Function: mdlUpdate =====
 * Abstract:
 *      xdot = Ax + Bu
 */
static void mdlUpdate(SimStruct *S, int_T tid)
{
    real_T          tempX[2] = {0.0, 0.0};
    real_T          *x        = ssGetRealDiscStates(S);
    InputRealPtrsType uPtrs   = ssGetInputPortRealSignalPtrs(S,0);

    UNUSED_ARG(tid); /* not used in single tasking mode */

    /* xdot=Ax+Bu */
    tempX[0]=A[0][0]*x[0]+A[0][1]*x[1]+B[0][0]*U(0)+B[0][1]*U(1);
    tempX[1]=A[1][0]*x[0]+A[1][1]*x[1]+B[1][0]*U(0)+B[1][1]*U(1);

    x[0]=tempX[0];
    x[1]=tempX[1];
}

```

The required `mdlTerminate` function performs any actions, such as freeing memory, necessary at the end of the simulation. In this example, the function is empty.

```
/* Function: mdlTerminate =====
 * Abstract:
 *   No termination needed, but we are required to have this routine.
 */
static void mdlTerminate(SimStruct *S)
{
    UNUSED_ARG(S); /* unused input argument */
}
```

The required S-function trailer includes the files necessary for simulation or code generation, as follows.

```
#ifdef MATLAB_MEX_FILE /* Is this file being compiled as a MEX file? */
#include "simulink.c" /* MEX file interface mechanism */
#else
#include "cg_sfuns.h" /* Code generation registration function */
#endif
```

Note The `mdlOutputs` and `mdlTerminate` functions use the `UNUSED_ARG` macro to indicate that an input argument the callback requires is not used. This optional macro is defined in `simstruc_types.h`. If used, you must call this macro once for each input argument that a callback does not use.

Continuous and Discrete States

The `mixedm.c` example shows a hybrid (a combination of continuous and discrete states) system. The `mixedm.c` example combines elements of `csfunc.c` and `dsfunc.c`. The following Simulink model uses this S-function.

```
sfcn_demo_mixedm
```

If you have a hybrid system, the `mdlDerivatives` method calculates the derivatives of the continuous states of the state vector, `x`, and the `mdlUpdate`

method contains the equations used to update the discrete state vector, xD . The `mdlOutputs` method computes the S-function outputs after checking for sample hits to determine at what point the S-function is being called.

In Simulink block diagram form, the S-function `mixedm.c` looks like

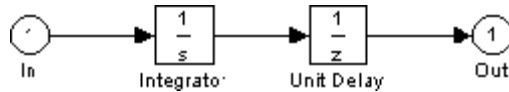

which implements a continuous integrator followed by a discrete unit delay.

matlabroot/simulink/src/mixedm.c

The S-function begins with `#define` statements for the S-function name and level, along with a `#include` statement for the `simstruc.h` header. After these statements, the S-function can include or define any other necessary headers, data, etc. The `mixedm.c` example defines `U` as a pointer to the first input port's signal.

```

/* File      : mixedm.c
 * Abstract:
 *
 *      An example S-function illustrating multiple sample times by implementing
 *      integrator -> ZOH(Ts=1second) -> UnitDelay(Ts=1second)
 *      with an initial condition of 1.
 *      (e.g. an integrator followed by unit delay operation).
 *
 *      For more details about S-functions, see simulink/src/sfuntmpl_doc.c
 *
 *      Copyright 1990-2007 The MathWorks, Inc.
 */

#define S_FUNCTION_NAME mixedm
#define S_FUNCTION_LEVEL 2

#include "simstruc.h"

#define U(element) (*uPtrs[element]) /* Pointer to Input Port0 */

```

The required S-function method `mdlInitializeSizes` then sets up the following S-function characteristics.

- `ssSetNumSFcnParams` sets the number of expected S-function dialog parameters to zero.
- `ssGetSFcnParamsCount` determines how many parameters the user actually entered into the S-function dialog. If the number of user-specified parameters does not match the number returned by `ssSetNumSFcnParams`, the S-function errors out.
- If the S-function parameter count passes, `mdlInitializeSizes` next sets the number of continuous and discrete states using `ssSetNumContStates` and `ssSetNumDiscStates`, respectively. This example has one continuous state and one discrete state.
- The S-function initializes one floating-point work vector by passing a value of 1 to `ssSetNumRWork`. No other work vectors are initialized.
- Next, the method uses `ssSetNumInputPorts` and `ssSetNumOutputPorts` to configure the S-function to have a single input and output port, each with a width of one. The method passes a value of 1 to `ssSetInputPortDirectFeedThrough` to indicate the input port has direct feedthrough.
- This S-function assigns sample times using a hybrid block-based and port-based method. The macro `ssSetNumSampleTimes` initializes two block-based sample times, which the `mdlInitializeSampleTimes` function configures later. The macros `ssSetInputPortSampleTime` and `ssSetInputPortOffsetTime` initialize the input port to have a continuous sample time with an offset of zero. Similarly, `ssSetOutputPortSampleTime` and `ssSetOutputPortOffsetTime` initialize the output port sample time to 1 with an offset of zero.
- Lastly, `ssSetOptions` sets two S-function options. `SS_OPTION_EXCEPTION_FREE_CODE` stipulates that the code is exception free and `SS_OPTION_PORT_SAMPLE_TIMES_ASSIGNED` indicates a combination of block-based and port-based sample times.

The `mdlInitializeSizes` function for this example is shown below.

```
*=====*
* S-function methods *
```



```

*=====*/

/* Function: mdlInitializeSizes =====
* Abstract:
*   Determine the S-function block's characteristics:
*   number of inputs, outputs, states, etc.
*/
static void mdlInitializeSizes(SimStruct *S)
{
    ssSetNumSFcnParams(S, 0); /* Number of expected parameters */
    if (ssGetNumSFcnParams(S) != ssGetSFcnParamsCount(S)) {
        return; /* Parameter mismatch reported by the Simulink engine*/
    }

    ssSetNumContStates(S, 1);
    ssSetNumDiscStates(S, 1);
    ssSetNumRWork(S, 1); /* for zoh output feeding the delay operator */

    if (!ssSetNumInputPorts(S, 1)) return;
    ssSetInputPortWidth(S, 0, 1);
    ssSetInputPortDirectFeedThrough(S, 0, 1);
    ssSetInputPortSampleTime(S, 0, CONTINUOUS_SAMPLE_TIME);
    ssSetInputPortOffsetTime(S, 0, 0.0);

    if (!ssSetNumOutputPorts(S, 1)) return;
    ssSetOutputPortWidth(S, 0, 1);
    ssSetOutputPortSampleTime(S, 0, 1.0);
    ssSetOutputPortOffsetTime(S, 0, 0.0);

    ssSetNumSampleTimes(S, 2);

    /* Take care when specifying exception free code - see sfuntmpl_doc.c. */
    ssSetOptions(S, (SS_OPTION_EXCEPTION_FREE_CODE |
                    SS_OPTION_PORT_SAMPLE_TIMES_ASSIGNED));
} /* end mdlInitializeSizes */

```

The required S-function method `mdlInitializeSampleTimes` specifies the S-function block-based sample rates. The first call to `ssSetSampleTime` specifies that the first sample rate is continuous, with the subsequent

call to `ssSetOffsetTime` setting the offset to zero. The second call to this pair of macros sets the second sample time to 1 with an offset of zero. The S-function port-based sample times set in `mdlInitializeSizes` must all be registered as a block-based sample time. The call to `ssSetModelReferenceSampleTimeDefaultInheritance` tells the solver to use the default rule to determine if submodels containing this S-function can inherit their sample times from the parent model.

```
/* Function: mdlInitializeSampleTimes =====
 * Abstract:
 *   Two tasks: One continuous, one with discrete sample time of 1.0.
 */
static void mdlInitializeSampleTimes(SimStruct *S)
{
    ssSetSampleTime(S, 0, CONTINUOUS_SAMPLE_TIME);
    ssSetOffsetTime(S, 0, 0.0);

    ssSetSampleTime(S, 1, 1.0);
    ssSetOffsetTime(S, 1, 0.0);
    ssSetModelReferenceSampleTimeDefaultInheritance(S);
} /* end mdlInitializeSampleTimes */
```

The optional S-function method `mdlInitializeConditions` initializes the continuous and discrete state vectors. The `#define` statement before this method is required for the Simulink engine to call this function. In this example, `ssGetContStates` obtains a pointer to the continuous state vector and `ssGetRealDiscStates` obtains a pointer to the discrete state vector. The method then sets all states' initial conditions to one.

```
#define MDL_INITIALIZE_CONDITIONS
/* Function: mdlInitializeConditions =====
 * Abstract:
 *   Initialize both continuous states to one.
 */
static void mdlInitializeConditions(SimStruct *S)
{
    real_T *xC0 = ssGetContStates(S);
    real_T *xD0 = ssGetRealDiscStates(S);

    xC0[0] = 1.0;
```

```

        xD0[0] = 1.0;

    } /* end mdlInitializeConditions */

```

The required `mdlOutputs` function performs computations based on the current task. The macro `ssIsContinuousTask` checks if the continuous task is executing. If this macro returns `true`, `ssIsSpecialSampleHit` then checks if the discrete sample rate is also executing. If this macro also returns `true`, the method sets the value of the floating-point work vector to the current value of the continuous state, via pointers obtained using `ssGetRWork` and `ssGetContStates`, respectively. The `mdlUpdate` method later uses the floating-point work vector as the input to the zero-order hold. Updating the work vector in `mdlOutputs` ensures that the correct values are available during subsequent calls to `mdlUpdate`. Finally, if the S-function is running at its discrete rate, i.e., the call to `ssIsSampleHit` returns `true`, the method sets the output to the value of the discrete state.

```

/* Function: mdlOutputs =====
 * Abstract:
 *     y = xD, and update the zoh internal output.
 */
static void mdlOutputs(SimStruct *S, int_T tid)
{
    /* update the internal "zoh" output */
    if (ssIsContinuousTask(S, tid)) {
        if (ssIsSpecialSampleHit(S, 1, 0, tid)) {
            real_T *zoh = ssGetRWork(S);
            real_T *xC = ssGetContStates(S);
            *zoh = *xC;
        }
    }

    /* y=xD */
    if (ssIsSampleHit(S, 1, tid)) {
        real_T *y = ssGetOutputPortRealSignal(S,0);
        real_T *xD = ssGetRealDiscStates(S);
        y[0]=xD[0];
    }
}

```

```
} /* end mdlOutputs */
```

The Simulink engine calls the `mdlUpdate` function once every major integration time step to update the discrete states' values. Because this function is an optional method, a `#define` statement must precede the function. The call to `ssIsSampleHit` ensures the body of the method is executed only when the S-function is operating at its discrete rate. If `ssIsSampleHit` returns `true`, the method obtains pointers to the S-function discrete state and floating-point work vector and updates the discrete state's value using the value stored in the work vector.

```
#define MDL_UPDATE
/* Function: mdlUpdate =====
 * Abstract:
 *      xD = xC
 */
static void mdlUpdate(SimStruct *S, int_T tid)
{
    UNUSED_ARG(tid); /* not used in single tasking mode */

    /* xD=xC */
    if (ssIsSampleHit(S, 1, tid)) {
        real_T *xD = ssGetRealDiscStates(S);
        real_T *zoh = ssGetRWork(S);
        xD[0]=*zoh;
    }
} /* end mdlUpdate */
```

The `mdlDerivatives` function calculates the continuous state derivatives. Because this function is an optional method, a `#define` statement must precede the function. The function obtains pointers to the S-function continuous state derivative and first input port then sets the continuous state derivative equal to the value of the first input.

```
#define MDL_DERIVATIVES
/* Function: mdlDerivatives =====
 * Abstract:
 *      xdot = U
 */
static void mdlDerivatives(SimStruct *S)
```

```

{
    real_T          *dx   = ssGetdX(S);
    InputRealPtrsType uPtrs = ssGetInputPortRealSignalPtrs(S,0);

    /* xdot=U */
    dx[0]=U(0);

} /* end mdlDerivatives */

```

The required `mdlTerminate` function performs any actions, such as freeing memory, necessary at the end of the simulation. In this example, the function is empty.

```

/* Function: mdlTerminate =====
 * Abstract:
 *   No termination needed, but we are required to have this routine.
 */
static void mdlTerminate(SimStruct *S)
{
    UNUSED_ARG(S); /* unused input argument */
}

```

The S-function trailer includes the files necessary for simulation or code generation, as follows.

```

#ifdef MATLAB_MEX_FILE /* Is this file being compiled as a MEX file? */
#include "simulink.c" /* MEX file interface mechanism */
#else
#include "cg_sfun.h" /* Code generation registration function */
#endif

```

Note The `mdlUpdate` and `mdlTerminate` functions use the `UNUSED_ARG` macro to indicate that an input argument the callback requires is not used. This optional macro is defined in `simstruc_types.h`. If used, you must call this macro once for each input argument that a callback does not use.

Variable Sample Time

The example S-function `vsfunc.c` uses a variable-step sample time. The following Simulink model uses this S-function.

```
sfcn_demo_vsfunc
```

Variable step-size functions require a call to `mdlGetTimeOfNextVarHit`, which is an S-function routine that calculates the time of the next sample hit. S-functions that use the variable-step sample time can be used only with variable-step solvers. The `vsfunc.c` example is a discrete S-function that delays its first input by an amount of time determined by the second input.

The `vsfunc.c` example outputs the input `u` delayed by a variable amount of time. `mdlOutputs` sets the output `y` equal to state `x`. `mdlUpdate` sets the state vector `x` equal to `u`, the input vector. This example calls `mdlGetTimeOfNextVarHit` to calculate and set the time of the next sample hit, that is, the time when `vsfunc.c` is next called. In `mdlGetTimeOfNextVarHit`, the macro `ssGetInputPortRealSignalPtrs` gets a pointer to the input `u`. Then this call is made:

```
ssSetTNext(S, ssGetT(S) + U(1));
```

The macro `ssGetT` gets the simulation time `t`. The second input to the block, `U(1)`, is added to `t`, and the macro `ssSetTNext` sets the time of the next hit equal to `t+U(1)`, delaying the output by the amount of time set in `U(1)`.

matlabroot/simulink/src/vsfunc.c

The S-function begins with `#define` statements for the S-function name and level, along with a `#include` statement for the `simstruc.h` header. After these statements, the S-function can include or define any other necessary headers, data, etc. The `vsfunc.c` example defines `U` as a pointer to the first input port's signal.

```
/* File      : vsfunc.c
 * Abstract:
 *
 *      Variable step S-function example.
 *      This example S-function illustrates how to create a variable step
 *      block. This block implements a variable step delay
```

```

*      in which the first input is delayed by an amount of time determined
*      by the second input:
*
*      dt      = u(2)
*      y(t+dt) = u(t)
*
*      For more details about S-functions, see simulink/src/sfuntmpl_doc.c.
*
*      Copyright 1990-2007 The MathWorks, Inc.
*/

```

```

#define S_FUNCTION_NAME vsfunc
#define S_FUNCTION_LEVEL 2

#include "simstruc.h"

#define U(element) (*uPtrs[element]) /* Pointer to Input Port0 */

```

The required S-function method `mdlInitializeSizes` then sets up the following S-function characteristics.

- `ssSetNumSFcnParams` sets the number of expected S-function dialog parameters to zero.
- `ssGetSFcnParamsCount` determines how many parameters the user actually entered into the S-function dialog. If the number of user-specified parameters does not match the number returned by `ssSetNumSFcnParams`, the S-function errors out.
- If the S-function parameter count passes, `mdlInitializeSizes` next sets the number of continuous and discrete states using `ssSetNumContStates` and `ssSetNumDiscStates`, respectively. This example has no continuous states and one discrete state.
- Next, the method uses `ssSetNumInputPorts` and `ssSetNumOutputPorts` to configure the S-function to have a single input and output port. Calls to `ssSetInputPortWidth` and `ssSetOutputPortWidth` assign widths to these input and output ports. The method passes a value of 1 to `ssSetInputPortDirectFeedThrough` to indicate the input port has direct feedthrough.

- `ssSetNumSampleTimes` then initializes one sample time, which the `mdlInitializeSampleTimes` function configures later.
- The S-function indicates that no work vectors are used by passing a value of 0 to `ssSetNumRWork`, `ssSetNumIWork`, etc. You can omit these lines because zero is the default value for all of these macros. However, for clarity, the S-function explicitly sets the number of work vectors.
- Next, `ssGetSimMode` checks if the S-function is being run in a simulation or by the Simulink Coder product. If `ssGetSimMode` returns `SS_SIMMODE_RTWGEN` and `ssIsVariableStepSolver` returns `false`, indicating use with the Simulink Coder product and a fixed-step solver, then the S-function errors out.
- Lastly, `ssSetOptions` sets any applicable options. In this case, the only option is `SS_OPTION_EXCEPTION_FREE_CODE`, which stipulates that the code is exception free.

The `mdlInitializeSizes` function for this example is shown below.

```
/* Function: mdlInitializeSizes =====
 * Abstract:
 *   Determine the S-function block's characteristics:
 *   number of inputs, outputs, states, etc.
 */
static void mdlInitializeSizes(SimStruct *S)
{
    ssSetNumSFcnParams(S, 0); /* Number of expected parameters */
    if (ssGetNumSFcnParams(S) != ssGetSFcnParamsCount(S)) {
        return; /* Parameter mismatch reported by the Simulink engine*/
    }

    ssSetNumContStates(S, 0);
    ssSetNumDiscStates(S, 1);

    if (!ssSetNumInputPorts(S, 1)) return;
    ssSetInputPortWidth(S, 0, 2);
    ssSetInputPortDirectFeedThrough(S, 0, 1);

    if (!ssSetNumOutputPorts(S, 1)) return;
    ssSetOutputPortWidth(S, 0, 1);
}
```



```

    ssSetNumSampleTimes(S, 1);
    ssSetNumRWork(S, 0);
    ssSetNumIWork(S, 0);
    ssSetNumPWork(S, 0);
    ssSetNumModes(S, 0);
    ssSetNumNonsampledZCs(S, 0);

    if (ssGetSimMode(S) == SS_SIMMODE_RTWGEN && !ssIsVariableStepSolver(S)) {
        ssSetErrorStatus(S, "S-function vsfunc.c cannot be used with RTW "
            "and Fixed-Step Solvers because it contains variable"
            " sample time");
    }

    /* Take care when specifying exception free code - see sfuntmpl_doc.c */
    ssSetOptions(S, SS_OPTION_EXCEPTION_FREE_CODE);
}

```

The required S-function method `mdlInitializeSampleTimes` specifies the S-function sample rates. The input argument `VARIABLE_SAMPLE_TIME` passed to `ssSetSampleTime` specifies that this S-function has a variable-step sample time and `ssSetOffsetTime` specifies an offset time of zero. The call to `ssSetModelReferenceSampleTimeDefaultInheritance` tells the solver to use the default rule to determine if submodels containing this S-function can inherit their sample times from the parent model. Because the S-function has a variable-step sample time, `vsfunc.c` must calculate the time of the next sample hit in the `mdlGetTimeOfNextVarHit` method, shown later.

```

/* Function: mdlInitializeSampleTimes =====
 * Abstract:
 *   Variable-Step S-function
 */
static void mdlInitializeSampleTimes(SimStruct *S)
{
    ssSetSampleTime(S, 0, VARIABLE_SAMPLE_TIME);
    ssSetOffsetTime(S, 0, 0.0);
    ssSetModelReferenceSampleTimeDefaultInheritance(S);
}

```

The optional S-function method `mdlInitializeConditions` initializes the discrete state vector. The `#define` statement before this method is required

for the Simulink engine to call this function. In the example, the method uses `ssGetRealDiscStates` to obtain a pointer to the discrete state vector and sets the state's initial value to zero.

```
#define MDL_INITIALIZE_CONDITIONS
/* Function: mdlInitializeConditions =====
 * Abstract:
 *   Initialize discrete state to zero.
 */
static void mdlInitializeConditions(SimStruct *S)
{
    real_T *x0 = ssGetRealDiscStates(S);

    x0[0] = 0.0;
}
```

The optional `mdlGetTimeOfNextVarHit` method calculates the time of the next sample hit. Because this method is optional, a `#define` statement precedes it. First, this method obtains a pointer to the first input port's signal using `ssGetInputPortRealSignalPtrs`. If the input signal's second element is positive, the macro `ssGetT` gets the simulation time `t`. The macro `ssSetTNext` sets the time of the next hit equal to `t+(U[1])`, delaying the output by the amount of time specified by the input's second element (`*U[1]`).

```
#define MDL_GET_TIME_OF_NEXT_VAR_HIT
static void mdlGetTimeOfNextVarHit(SimStruct *S)
{
    InputRealPtrsType uPtrs = ssGetInputPortRealSignalPtrs(S,0);

    /* Make sure input will increase time */
    if (U(1) <= 0.0) {
        /* If not, abort simulation */
        ssSetErrorStatus(S,"Variable step control input must be "
            "greater than zero");
        return;
    }
    ssSetTNext(S, ssGetT(S)+U(1));
}
```

The required `mdlOutputs` function computes the S-function output signal. The function obtains pointers to the first output port and discrete state and then assigns the state's current value to the output.

```

/* Function: mdlOutputs =====
 * Abstract:
 *     y = x
 */
static void mdlOutputs(SimStruct *S, int_T tid)
{
    real_T *y = ssGetOutputPortRealSignal(S,0);
    real_T *x = ssGetRealDiscStates(S);

    /* Return the current state as the output */
    y[0] = x[0];
}

```

The `mdlUpdate` function updates the discrete state's value. Because this method is optional, a `#define` statement precedes it. The function first obtains pointers to the S-function discrete state and first input port then assigns the value of the first element of the first input port signal to the state.

```

#define MDL_UPDATE
/* Function: mdlUpdate =====
 * Abstract:
 *     This function is called once for every major integration time step.
 *     Discrete states are typically updated here, but this function is useful
 *     for performing any tasks that should only take place once per integration
 *     step.
 */
static void mdlUpdate(SimStruct *S, int_T tid)
{
    real_T *x = ssGetRealDiscStates(S);
    InputRealPtrsType uPtrs = ssGetInputPortRealSignalPtrs(S,0);

    x[0]=U(0);
}

```

The required `mdlTerminate` function performs any actions, such as freeing memory, necessary at the end of the simulation. In this example, the function is empty.

```
/* Function: mdlTerminate =====  
 * Abstract:  
 *   No termination needed, but we are required to have this routine.  
 */  
static void mdlTerminate(SimStruct *S)  
{  
}
```

The required S-function trailer includes the files necessary for simulation or code generation, as follows.

```
#ifdef MATLAB_MEX_FILE /* Is this file being compiled as a MEX file? */  
#include "simulink.c" /* MEX file interface mechanism */  
#else  
#include "cg_sfuns.h" /* Code generation registration function */  
#endif
```

Array Inputs and Outputs

The example S-function `sfun_matadd.c` demonstrates how to implement a matrix addition block. The following Simulink model uses this S-function.

`sfcdemo_matadd`

The S-function adds signals of various dimensions to a parameter value entered in the S-function. The S-function accepts and outputs 2-D or n-D signals.

matlabroot/simulink/src/sfun_matadd.c

The S-function begins with `#define` statements for the S-function name and level, along with a `#include` statement for the `simstruc.h` header. After these statements, the S-function includes or defines any other necessary headers, data, etc. This example defines additional variables for the number of S-function parameters, the S-function parameter value, and the flag `EDIT_OK` that indicates if the parameter value can be edited during simulation.

```

/* SFUN_MATADD matrix support example.
 * C MEX S-function for matrix addition with one input port,
 * one output port, and one parameter.
 *
 * Input Signal: 2-D or n-D array
 * Parameter:    2-D or n-D array
 * Output Signal: 2-D or n-D array
 *
 * Input   parameter   output
 * -----
 * scalar  scalar      scalar
 * scalar  matrix      matrix   (input scalar expansion)
 * matrix  scalar      matrix   (parameter scalar expansion)
 * matrix  matrix      matrix
 *
 * Copyright 1990-2007 The MathWorks, Inc.
 */
#define S_FUNCTION_NAME  sfun_matadd
#define S_FUNCTION_LEVEL 2

#include "simstruc.h"

enum {PARAM = 0, NUM_PARAMS};

#define PARAM_ARG  ssGetSFcnParam(S, PARAM)

#define EDIT_OK(S, ARG) \
    (!(ssGetSimMode(S) == SS_SIMMODE_SIZES_CALL_ONLY) \
    && mxIsEmpty(ARG))

The S-function next implements the mdlCheckParameters method to validate
the S-function dialog parameters. The #ifdef statement checks that the
S-function is compiled as a MEX file, instead of for use with the Simulink
Coder product. Because mdlCheckParameters is optional, the S-function code
contains a #define statement to register the method. The body of the function
checks that the S-function parameter value is not empty. If the parameter
check fails, the S-function errors out with a call to ssSetErrorStatus.

#ifdef MATLAB_MEX_FILE
#define MDL_CHECK_PARAMETERS

```

```
/* Function: mdlCheckParameters =====  
  
* Abstract:  
*   Verify parameter settings.  
*/  
static void mdlCheckParameters(SimStruct *S)  
{  
    if(EDIT_OK(S, PARAM_ARG)){  
        /* Check that parameter value is not empty*/  
        if( mxIsEmpty(PARAM_ARG) ) {  
            ssSetErrorStatus(S, "Invalid parameter specified. The"  
                "parameter must be non-empty");  
            return;  
        }  
    }  
} /* end mdlCheckParameters */  
#endif
```

The required S-function method `mdlInitializeSizes` then sets up the following S-function characteristics.

- `ssSetNumSFcnParams` sets the number of expected S-function dialog parameters to one, as defined by the variable `NUM_PARAMS`.
- If this S-function is compiled as a MEX file, `ssGetSFcnParamsCount` determines how many parameters the user actually entered into the S-function dialog. If the number of user-specified parameters matches the number returned by `ssGetNumSFcnParams`, the method calls `mdlCheckParameters` to validate the user-entered data. Otherwise, the S-function errors out.
- If the parameter check passes, the S-function specifies that all S-function parameters are tunable using `ssSetSFcnParamTunable`.
- The S-function then invokes `ssAllowSignalsWithMoreThan2D` to allow the S-function to accept n-D signals.
- Next, `ssSetNumOutputPorts` and `ssSetNumInputPorts` specify that the S-function has a single output port and a single input port.
- The S-function uses `ssSetInputPortDimensionInfo` to specify that the input port is dynamically sized. In this case, the S-function needs to

implement an `mdlSetInputPortDimensionInfo` method to set the actual input dimension.

- The output dimensions depend on the dimensions of the S-function parameter. If the parameter is a scalar, the call to `ssSetOutputPortDimensionInfo` specifies that the output port dimensions are dynamically sized. If the parameter is a matrix, the output port dimensions are initialized to the dimensions of the S-function parameter. In this case, the macro `DECL_AND_INIT_DIMSINFO` initializes a `dimsInfo` structure. The S-function assigns the width, size, and dimensions of the S-function parameter into the `dimsInfo` structure and then passes this structure to `ssSetOutputPortDimensionInfo` in order to set the output port dimensions accordingly.
- The S-function specifies that the input port has direct feedthrough by passing a value of 1 to `ssSetInputPortDirectFeedThrough`.
- `ssSetNumSampleTimes` initializes one sample time, to be configured later in the `mdlInitializeSampleTimes` method.
- Lastly, `ssSetOptions` sets any applicable options. In this case, `SS_OPTION_EXCEPTION_FREE_CODE` stipulates that the code is exception free and `SS_OPTION_WORKS_WITH_CODE_REUSE` signifies that this S-function is compatible with the subsystem code reuse feature of the Simulink Coder product.

```

/* Function: mdlInitializeSizes =====
 * Abstract:
 *   Initialize the sizes array
 */
static void mdlInitializeSizes(SimStruct *S)
{
    ssSetNumSFcnParams(S, NUM_PARAMS);

    #if defined(MATLAB_MEX_FILE)
        if (ssGetNumSFcnParams(S) != ssGetSFcnParamsCount(S)) {
            return; }
        mdlCheckParameters(S);
        if (ssGetErrorStatus(S) != NULL) return;
    #endif

    {

```

```

int iParam = 0;
int nParam = ssGetNumSFcnParams(S);

for ( iParam = 0; iParam < nParam; iParam++ )
{
    ssSetSFcnParamTunable( S, iParam, SS_PRM_TUNABLE );
}
}

/* Allow signal dimensions greater than 2 */
ssAllowSignalsWithMoreThan2D(S);

/* Set number of input and output ports */
if (!ssSetNumInputPorts( S,1)) return;
if (!ssSetNumOutputPorts(S,1)) return;

/* Set dimensions of input and output ports */
{
    int_T pWidth = mxGetNumberOfElements(PARAM_ARG);
    /* Input can be a scalar or a matrix signal. */
    if(!ssSetInputPortDimensionInfo(S,0,DYNAMIC_DIMENSION)) {
        return; }

    if( pWidth == 1) {
        /* Scalar parameter: output dimensions are unknown. */
        if(!ssSetOutputPortDimensionInfo(S,0,DYNAMIC_DIMENSION)){
            return; }
        }
    else{
        /*
         * Non-scalar parameter: output dimensions are the same
         * as the parameter dimensions. To support n-D signals,
         * must use a dimsInfo structure to specify dimensions.
         */
        DECL_AND_INIT_DIMSINFO(di); /*Initializes structure*/
        int_T      pSize = mxGetNumberOfDimensions(PARAM_ARG);
        const int_T *pDims = mxGetDimensions(PARAM_ARG);
        di.width   = pWidth;
        di.numDims = pSize;
        di.dims    = pDims;
    }
}

```



```

        if(!ssSetOutputPortDimensionInfo(S, 0, &di)) return;
    }
}
ssSetInputPortDirectFeedThrough(S, 0, 1);

ssSetNumSampleTimes(S, 1);
ssSetOptions(S,
             SS_OPTION_WORKS_WITH_CODE_REUSE |
             SS_OPTION_EXCEPTION_FREE_CODE);
} /* end mdlInitializeSizes */

```

The required S-function method `mdlInitializeSampleTimes` specifies the S-function sample rates. To specify that this S-function inherits its sample time from its driving block, the S-function calls `ssSetSampleTime` with the input argument `INHERITED_SAMPLE_TIME`. The call to `ssSetModelReferenceSampleTimeDefaultInheritance` tells the solver to use the default rule to determine if submodels containing this S-function can inherit their sample times from the parent model.

```

/* Function: mdlInitializeSampleTimes =====
 * Abstract:
 *   Initialize the sample times array.
 */
static void mdlInitializeSampleTimes(SimStruct *S)
{
    ssSetSampleTime(S, 0, INHERITED_SAMPLE_TIME);
    ssSetOffsetTime(S, 0, 0.0);
    ssSetModelReferenceSampleTimeDefaultInheritance(S);
} /* end mdlInitializeSampleTimes */

```

The S-function calls the `mdlSetWorkWidths` method to register its run-time parameters. Because `mdlSetWorkWidths` is an optional method, a `#define` statement precedes it. The method first initializes a name for the run-time parameter and then uses `ssRegAllTunableParamsAsRunTimeParams` to register the run-time parameter.

```

/* Function: mdlSetWorkWidths =====
 * Abstract:
 *   Set up run-time parameter.
 */
#define MDL_SET_WORK_WIDTHS

```

```

static void mdlSetWorkWidths(SimStruct *S)
{
    const char_T    *rtParamNames[] = {"Operand"};
    ssRegAllTunableParamsAsRunTimeParams(S, rtParamNames);
} /* end mdlSetWorkWidths */

```

The S-function `mdlOutputs` method uses a `for` loop to calculate the output as the sum of the input and S-function parameter. The S-function handles n-D arrays of data using a single index into the array.

```

/* Function: mdlOutputs =====
 * Abstract:
 *   Compute the outputs of the S-function.
 */
static void mdlOutputs(SimStruct *S, int_T tid)
{
    InputRealPtrsType uPtr = ssGetInputPortRealSignalPtrs(S,0);
    real_T            *y    = ssGetOutputPortRealSignal(S,0);
    const real_T      *p    = mxGetPr(PARAM_ARG);

    int_T            uWidth = ssGetInputPortWidth(S,0);
    int_T            pWidth = mxGetNumberOfElements(PARAM_ARG);
    int_T            yWidth = ssGetOutputPortWidth(S,0);
    int              i;

    UNUSED_ARG(tid); /* not used in single tasking mode */

    /*
     * Note1: Matrix signals are stored in column major order.
     * Note2: Access each matrix element by one index not two
     *         indices. For example, if the output signal is a
     *         [2x2] matrix signal,
     *         -   -
     *         | y[0] y[2] |
     *         | y[1] y[3] |
     *         -   -
     *         Output elements are stored as follows:
     *         y[0] --> row = 0, col = 0
     *         y[1] --> row = 1, col = 0
     *         y[2] --> row = 0, col = 1
    */
}

```

```

*           y[3] --> row = 1, col = 1
*/

for (i = 0; i < yWidth; i++) {
    int_T uIdx = (uWidth == 1) ? 0 : i;
    int_T pIdx = (pWidth == 1) ? 0 : i;

    y[i] = *uPtr[uIdx] + p[pIdx];
}
} /* end mdlOutputs */

```

During signal propagation, the S-function calls the optional `mdlSetInputPortDimensionInfo` method with the candidate input port dimensions stored in `dimsInfo`. The `#if defined` statement checks that the S-function is compiled as a MEX file. Because `mdlSetInputPortDimensionInfo` is an optional method, a `#define` statement precedes it. In `mdlSetInputPortDimensionInfo`, the S-function uses `ssSetInputPortDimensionInfo` to set the dimensions of the input port to the candidate dimensions. If the call to this macro succeeds, the S-function further checks the candidate dimensions to ensure that the input signal is either a 2-D scalar or a matrix. If this condition is met and the output port dimensions are still dynamically sized, the S-function calls `ssSetOutputPortDimensionInfo` to set the dimension of the output port to the same candidate dimensions. The `ssSetOutputPortDimensionInfo` macro cannot modify the output port dimensions if they are already specified.

```

#if defined(MATLAB_MEX_FILE)
#define MDL_SET_INPUT_PORT_DIMENSION_INFO
/* Function: mdlSetInputPortDimensionInfo =====
* Abstract:
*   This routine is called with the candidate dimensions for
*   an input port with unknown dimensions. If the proposed
*   dimensions are acceptable, the routine should go ahead and
*   set the actual port dimensions. If they are unacceptable
*   an error should be generated via ssSetErrorStatus.
*   Note that any other input or output ports whose dimensions
*   are implicitly defined by virtue of knowing the dimensions
*   of the given port can also have their dimensions set.
*/
static void mdlSetInputPortDimensionInfo(SimStruct *S,

```

```

int_T          port,
const DimsInfo_T *dimsInfo)
{
    int_T pWidth          = mxGetNumberOfElements(PARAM_ARG);
    int_T pSize           = mxGetNumberOfDimensions(PARAM_ARG);
    const int_T *pDims    = mxGetDimensions(PARAM_ARG);

    int_T uNumDims = dimsInfo->numDims;
    int_T uWidth   = dimsInfo->width;
    int_T *uDims   = dimsInfo->dims;

    int_T numDims;
    boolean_T isOk = true;
    int iParam = 0;
    int_T outWidth = ssGetOutputPortWidth(S, 0);

    /* Set input port dimension */
    if(!ssSetInputPortDimensionInfo(S, port, dimsInfo)) return;

    /*
     * The block only accepts 2-D or higher signals. Check
     * number of dimensions. If the parameter and the input
     * signal are non-scalar, their dimensions must be the same.
     */
    isOk = (uNumDims >= 2) && (pWidth == 1 || uWidth == 1 ||
        pWidth == uWidth);
    numDims = (pSize != uNumDims) ? numDims : uNumDims;

    if(isOk && pWidth > 1 && uWidth > 1){
        for ( iParam = 0; iParam < numDims; iParam++ ) {
            isOk = (pDims[iParam] == uDims[iParam]);
            if(!isOk) break;
        }
    }

    if(!isOk){
        ssSetErrorStatus(S,"Invalid input port dimensions. The "
            "input signal must be a 2-D scalar signal, or it must "
            "be a matrix with the same dimensions as the parameter "
            "dimensions.");
    }
}

```

```

        return;
    }

    /* Set the output port dimensions */
    if (outWidth == DYNAMICALLY_SIZED){
        if(!ssSetOutputPortDimensionInfo(S,port,dimsInfo)) return;
    }
} /* end mdlSetInputPortDimensionInfo */

```

During signal propagation, if any output ports have unknown dimensions, the S-function calls the optional `mdlSetOutputPortDimensionInfo` method. Because this method is optional, a `#define` statement precedes it. In `mdlSetOutputPortDimensionInfo`, the S-function uses `ssSetOutputPortDimensionInfo` to set the dimensions of the output port to the candidate dimensions `dimsInfo`. If the call to this macro succeeds, the S-function further checks the candidate dimensions to ensure that the input signal is either a 2-D or n-D matrix. If this condition is not met, the S-function errors out with a call to `ssSetErrorStatus`. Otherwise, the S-function calls `ssSetInputPortDimensionInfo` to set the dimension of the input port to the same candidate dimensions.

```

#define MDL_SET_OUTPUT_PORT_DIMENSION_INFO
/* Function: mdlSetOutputPortDimensionInfo =====
 * Abstract:
 * This routine is called with the candidate dimensions for
 * an output port with unknown dimensions. If the proposed
 * dimensions are acceptable, the routine should go ahead and
 * set the actual port dimensions. If they are unacceptable
 * an error should be generated via ssSetErrorStatus.
 * Note that any other input or output ports whose dimensions
 * are implicitly defined by virtue of knowing the dimensions
 * of the given port can also have their dimensions set.
 */
static void mdlSetOutputPortDimensionInfo(SimStruct *S,
    int_T port,
    const DimsInfo_T *dimsInfo)
{
    /*
     * If the block has scalar parameter, the output dimensions
     * are unknown. Set the input and output port to have the

```

```

        * same dimensions.
        */
        if(!ssSetOutputPortDimensionInfo(S, port, dimsInfo)) return;

        /* The block only accepts 2-D or n-D signals.
        * Check number of dimensions.
        */
        if (!(dimsInfo->numDims >= 2)){
            ssSetErrorStatus(S, "Invalid output port dimensions. "
                "The output signal must be a 2-D or n-D array (matrix) "
                "signal.");
            return;
        }else{
            /* Set the input port dimensions */
            if(!ssSetInputPortDimensionInfo(S,port,dimsInfo)) return;
        }
    } /* end mdlSetOutputPortDimensionInfo */

```

Because the S-function has ports that are dynamically sized, it must provide an `mdlSetDefaultPortDimensionInfo` method. The Simulink engine invokes this method during signal propagation when it cannot determine the dimensionality of the signal connected to the block's input port. This situation can happen, for example, if the input port is unconnected. In this example, the `mdlSetDefaultPortDimensionInfo` method sets the input and output ports dimensions to a scalar.

```

# define MDL_SET_DEFAULT_PORT_DIMENSION_INFO
/* Function: mdlSetDefaultPortDimensionInfo =====
 * This routine is called when the Simulink engine is not able
 * to find dimension candidates for ports with unknown dimensions.
 * This function must set the dimensions of all ports with
 * unknown dimensions.
 */
static void mdlSetDefaultPortDimensionInfo(SimStruct *S)
{
    int_T outWidth = ssGetOutputPortWidth(S, 0);
    /* Input port dimension must be unknown. Set it to scalar.*/
    if(!ssSetInputPortMatrixDimensions(S, 0, 1, 1)) return;
    if(outWidth == DYNAMICALLY_SIZED){
        /* Output dimensions are unknown. Set it to scalar. */

```

```

        if(!ssSetOutputPortMatrixDimensions(S, 0, 1, 1)) return;
    }
} /* end mdlSetDefaultPortDimensionInfo */
#endif

```

The required `mdlTerminate` function performs any actions, such as freeing memory, necessary at the end of the simulation. In this example, the function is empty.

```

/* Function: mdlTerminate =====
 * Abstract:
 *   Called when the simulation is terminated.
 */
static void mdlTerminate(SimStruct *S)
{
    UNUSED_ARG(S); /* unused input argument */
} /* end mdlTerminate */

```

The required S-function trailer includes the files necessary for simulation or code generation.

```

#ifdef MATLAB_MEX_FILE
    #include "simulink.c"
#else
    #include "cg_sfun.h"
#endif

/* [EOF] sfun_matadd.c */

```

Note The `mdlOutputs` and `mdlTerminate` functions use the `UNUSED_ARG` macro to indicate that an input argument the callback requires is not used. This optional macro is defined in `simstruc_types.h`. You must call this macro once for each input argument that a callback does not use.

Zero-Crossing Detection

The example S-function `sfun_zc_sat.c` demonstrates how to implement a Saturation block. The following Simulink model uses this S-function.

sfcndemo_sfun_zc_sat

The S-function works with either fixed-step or variable-step solvers. When this S-function inherits a continuous sample time and uses a variable-step solver, it uses a zero-crossings algorithm to locate the exact points at which the saturation occurs.

matlabroot/simulink/src/sfun_zc_sat.c

The S-function begins with `#define` statements for the S-function name and level, along with a `#include` statement for the `simstruc.h` header. After these statements, the S-function includes or defines any other necessary headers, data, etc. This example defines various parameters associated with the upper and lower saturation bounds.

```
/* File      : sfun_zc_sat.c
 * Abstract:
 *
 *      Example of an S-function which has nonsampled zero crossings to
 *      implement a saturation function. This S-function is designed to be
 *      used with a variable or fixed step solver.
 *
 * A saturation is described by three equations
 *
 * (1)   y = UpperLimit
 * (2)   y = u
 * (3)   y = LowerLimit
 *
 * and a set of inequalities that specify which equation to use
 *
 * if                UpperLimit < u   then use (1)
 * if   LowerLimit <= u <= UpperLimit then use (2)
 * if   u < LowerLimit                then use (3)
 *
 * A key fact is that the valid equation 1, 2, or 3, can change at
 * any instant. Nonsampled zero crossing support helps the variable step
 * solvers locate the exact instants when behavior switches from one equation
 * to another.
 *
 * Copyright 1990-2007 The MathWorks, Inc.
```



```

*/

#define S_FUNCTION_NAME  sfun_zc_sat
#define S_FUNCTION_LEVEL 2

#include "simstruc.h"

/*=====
 * General Defines/macros *
 *=====*/

/* index to Upper Limit */
#define I_PAR_UPPER_LIMIT 0

/* index to Lower Limit */
#define I_PAR_LOWER_LIMIT 1

/* total number of block parameters */
#define N_PAR          2

/*
 * Make access to mxArray pointers for parameters more readable.
 */
#define P_PAR_UPPER_LIMIT  ( ssGetSFcnParam(S,I_PAR_UPPER_LIMIT) )
#define P_PAR_LOWER_LIMIT  ( ssGetSFcnParam(S,I_PAR_LOWER_LIMIT) )

```

This S-function next implements the `mdlCheckParameters` method to check the validity of the S-function dialog parameters. Because this method is optional, a `#define` statement precedes it. The `#if defined` statement checks that this function is compiled as a MEX file, instead of for use with the Simulink Coder product. The body of the function performs basic checks to ensure that the user entered real vectors of equal length for the upper and lower saturation limits. If the parameter checks fail, the S-function errors out.

```

#define      MDL_CHECK_PARAMETERS
#if defined(MDL_CHECK_PARAMETERS) && defined(MATLAB_MEX_FILE)

/* Function: mdlCheckParameters =====
 * Abstract:

```

```
* Check that parameter choices are allowable.
*/
static void mdlCheckParameters(SimStruct *S)
{
    int_T    i;
    int_T    numUpperLimit;
    int_T    numLowerLimit;
    const char *msg = NULL;

    /*
     * check parameter basics
     */
    for ( i = 0; i < N_PAR; i++ ) {
        if ( mxIsEmpty(    ssGetSFcnParam(S,i) ) ||
            mxIsSparse(    ssGetSFcnParam(S,i) ) ||
            mxIsComplex(    ssGetSFcnParam(S,i) ) ||
            !mxIsNumeric(    ssGetSFcnParam(S,i) ) ) {
            msg = "Parameters must be real vectors.";
            goto EXIT_POINT;
        }
    }

    /*
     * Check sizes of parameters.
     */
    numUpperLimit = mxGetNumberOfElements( P_PAR_UPPER_LIMIT );
    numLowerLimit = mxGetNumberOfElements( P_PAR_LOWER_LIMIT );

    if ( ( numUpperLimit != 1 ) &&
        ( numLowerLimit != 1 ) &&
        ( numUpperLimit != numLowerLimit ) ) {
        msg = "Number of input and output values must be equal.";
        goto EXIT_POINT;
    }

    /*
     * Error exit point
     */
EXIT_POINT:
    if (msg != NULL) {
```

```

        ssSetErrorStatus(S, msg);
    }
}
#endif /* MDL_CHECK_PARAMETERS */

```

The required S-function method `mdlInitializeSizes` sets up the following S-function characteristics.

- `ssSetNumSFcnParams` sets the number of expected S-function dialog parameters to two, as defined previously in the variable `N_PAR`.
- If this method is compiled as a MEX file, `ssGetSFcnParamsCount` determines how many parameters the user actually entered into the S-function dialog. If the number of user-specified parameters matches the number returned by `ssGetNumSFcnParams`, the method calls `mdlCheckParameters` to check the validity of the user-entered data. Otherwise, the S-function errors out.
- If the parameter check passes, the S-function determines the maximum number of elements entered into either the upper or lower saturation limit parameter. This number is needed later to determine the appropriate output width.
- Next, the number of continuous and discrete states is set using `ssSetNumContStates` and `ssSetNumDiscStates`, respectively. This example has no continuous or discrete states.
- The method specifies that the S-function has a single output port using `ssSetNumOutputPorts` and sets the width of this output port using `ssSetOutputPortWidth`. The output port width is either the maximum number of elements in the upper or lower saturation limit or is dynamically sized. Similar code specifies a single input port and indicates the input port has direct feedthrough by passing a value of 1 to `ssSetInputPortDirectFeedThrough`.
- `ssSetNumSampleTimes` initializes one sample time, which the `mdlInitializeSampleTimes` function configures later.
- The S-function indicates that no work vectors are used by passing a value of 0 to `ssSetNumRWork`, `ssSetNumIWork`, etc. You can omit these lines because zero is the default value for all of these macros. However, for clarity, the S-function explicitly sets the number of work vectors.

- The method initializes the zero-crossing detection work vectors using `ssSetNumModes` and `ssSetNumNonsampledZCs`. The `mdlSetWorkWidths` method specifies the length of these dynamically sized vectors later.
- Lastly, `ssSetOptions` sets any applicable options. In this case, `SS_OPTION_EXCEPTION_FREE_CODE` stipulates that the code is exception free and `SS_OPTION_ALLOW_INPUT_SCALAR_EXPANSION` permits scalar expansion of the input without having to provide an `mdlSetInputPortWidth` function.

The `mdlInitializeSizes` function for this example is shown below.

```
/* Function: mdlInitializeSizes =====
 * Abstract:
 *   Initialize the sizes array.
 */
static void mdlInitializeSizes(SimStruct *S)
{
    int_T numUpperLimit, numLowerLimit, maxNumLimit;

    /*
     * Set and Check parameter count
     */
    ssSetNumSFcnParams(S, N_PAR);

#ifdef MATLAB_MEX_FILE
    if (ssGetNumSFcnParams(S) == ssGetSFcnParamsCount(S)) {
        mdlCheckParameters(S);
        if (ssGetErrorStatus(S) != NULL) {
            return;
        }
    } else {
        return; /* Parameter mismatch reported by the Simulink engine*/
    }
#endif

    /*
     * Get parameter size info.
     */
    numUpperLimit = mxGetNumberOfElements( P_PAR_UPPER_LIMIT );
    numLowerLimit = mxGetNumberOfElements( P_PAR_LOWER_LIMIT );
}
```

```
if (numUpperLimit > numLowerLimit) {
    maxNumLimit = numUpperLimit;
} else {
    maxNumLimit = numLowerLimit;
}

/*
 * states
 */
ssSetNumContStates(S, 0);
ssSetNumDiscStates(S, 0);

/*
 * outputs
 * The upper and lower limits are scalar expanded
 * so their size determines the size of the output
 * only if at least one of them is not scalar.
 */
if (!ssSetNumOutputPorts(S, 1)) return;

if ( maxNumLimit > 1 ) {
    ssSetOutputPortWidth(S, 0, maxNumLimit);
} else {
    ssSetOutputPortWidth(S, 0, DYNAMICALLY_SIZED);
}

/*
 * inputs
 * If the upper or lower limits are not scalar then
 * the input is set to the same size. However, the
 * ssSetOptions below allows the actual width to
 * be reduced to 1 if needed for scalar expansion.
 */
if (!ssSetNumInputPorts(S, 1)) return;

ssSetInputPortDirectFeedThrough(S, 0, 1 );

if ( maxNumLimit > 1 ) {
    ssSetInputPortWidth(S, 0, maxNumLimit);
} else {
```

```
        ssSetInputPortWidth(S, 0, DYNAMICALLY_SIZED);
    }

    /*
     * sample times
     */
    ssSetNumSampleTimes(S, 1);

    /*
     * work
     */
    ssSetNumRWork(S, 0);
    ssSetNumIWork(S, 0);
    ssSetNumPWork(S, 0);

    /*
     * Modes and zero crossings:
     * If we have a variable-step solver and this block has a continuous
     * sample time, then
     *   o One mode element will be needed for each scalar output
     *     in order to specify which equation is valid (1), (2), or (3).
     *   o Two ZC elements will be needed for each scalar output
     *     in order to help the solver find the exact instants
     *     at which either of the two possible "equation switches"
     *     One will be for the switch from eq. (1) to (2);
     *     the other will be for eq. (2) to (3) and vice versa.
     * otherwise
     *   o No modes and nonsampled zero crossings will be used.
     */
    ssSetNumModes(S, DYNAMICALLY_SIZED);
    ssSetNumNonsampledZCs(S, DYNAMICALLY_SIZED);

    /*
     * options
     *   o No mexFunctions and no problematic mxFunctions are called
     *     so the exception free code option safely gives faster simulations.
     *   o Scalar expansion of the inputs is desired. The option provides
     *     this without the need to write mdlSetOutputPortWidth and
```

```

        *   mdlSetInputPortWidth functions.
        */
        ssSetOptions(S, ( SS_OPTION_EXCEPTION_FREE_CODE |
                          SS_OPTION_ALLOW_INPUT_SCALAR_EXPANSION));

    } /* end mdlInitializeSizes */

```

The required S-function method `mdlInitializeSampleTimes` specifies the S-function sample rates. The input argument `INHERITED_SAMPLE_TIME` passed to `ssSetSampleTime` specifies that this S-function inherits its sample time from its driving block. The call to `ssSetModelReferenceSampleTimeDefaultInheritance` tells the solver to use the default rule to determine if submodels containing this S-function can inherit their sample times from the parent model.

```

/* Function: mdlInitializeSampleTimes =====
 * Abstract:
 *   Specify that the block is continuous.
 */
static void mdlInitializeSampleTimes(SimStruct *S)
{
    ssSetSampleTime(S, 0, INHERITED_SAMPLE_TIME);
    ssSetOffsetTime(S, 0, 0);
    ssSetModelReferenceSampleTimeDefaultInheritance(S);
}

```

The optional method `mdlSetWorkWidths` initializes the size of the zero-crossing detection work vectors. Because this method is optional, a `#define` statement precedes it. The `#if defined` statement checks that the S-function is being compiled as a MEX file. Zero-crossing detection can be done only when the S-function is running at a continuous sample rate using a variable-step solver. The `if` statement uses `ssIsVariableStepSolver`, `ssGetSampleTime`, and `ssGetOffsetTime` to determine if this condition is met. If so, the method sets the number of modes equal to the width of the first output port and the number of nonsampled zero crossings to twice this amount. Otherwise, the method sets both values to zero.

```

#define      MDL_SET_WORK_WIDTHS
#if defined(MDL_SET_WORK_WIDTHS) && defined(MATLAB_MEX_FILE)
/* Function: mdlSetWorkWidths =====

```

```
* The width of the Modes and the ZCs depends on the width of the output.
* This width is not always known in mdlInitializeSizes so it is handled
* here.
*/
static void mdlSetWorkWidths(SimStruct *S)
{
    int nModes;
    int nNonsampledZCs;

    if (ssIsVariableStepSolver(S) &&
        ssGetSampleTime(S,0) == CONTINUOUS_SAMPLE_TIME &&
        ssGetOffsetTime(S,0) == 0.0) {

        int numOutput = ssGetOutputPortWidth(S, 0);

        /*
         * modes and zero crossings
         *   o One mode element will be needed for each scalar output
         *     in order to specify which equation is valid (1), (2), or (3).
         *   o Two ZC elements will be needed for each scalar output
         *     in order to help the solver find the exact instants
         *     at which either of the two possible "equation switches"
         *     One will be for the switch from eq. (1) to (2);
         *     the other will be for eq. (2) to (3) and vice versa.
         */
        nModes          = numOutput;
        nNonsampledZCs = 2 * numOutput;
    } else {
        nModes          = 0;
        nNonsampledZCs = 0;
    }
    ssSetNumModes(S,nModes);
    ssSetNumNonsampledZCs(S,nNonsampledZCs);
}
#endif /* MDL_SET_WORK_WIDTHS */
```

After declaring variables for the input and output signals, the `mdlOutputs` functions uses an `if-else` statement to create blocks of code used to calculate the output signal based on whether the S-function uses a fixed-step or variable-step solver. The `if` statement queries the length of the nonsampled

zero-crossing vector. If the length, set in `mdlWorkWidths`, is zero, then no zero-crossing detection is done and the output signals are calculated directly from the input signals. Otherwise, the function uses the mode work vector to determine how to calculate the output signal. If the simulation is at a major time step, i.e., `ssIsMajorTimeStep` returns true, `mdlOutputs` determines which mode the simulation is running in, either saturated at the upper limit, saturated at the lower limit, or not saturated. Then, for both major and minor time steps, the function calculates an output based on this mode. If the mode changed between the previous and current time step, then a zero crossing occurred. The `mdlZeroCrossings` function, not `mdlOutputs`, indicates this crossing to the solver.

```

/* Function: mdlOutputs =====
 * Abstract:
 *
 * A saturation is described by three equations
 *
 * (1)   y = UpperLimit
 * (2)   y = u
 * (3)   y = LowerLimit
 *
 * When this block is used with a fixed-step solver or it has a noncontinuous
 * sample time, the equations are used as it
 *
 * Now consider the case of this block being used with a variable-step solver
 * and it has a continuous sample time. Solvers work best on smooth problems.
 * In order for the solver to work without chattering, limit cycles, or
 * similar problems, it is absolutely crucial that the same equation be used
 * throughout the duration of a MajorTimeStep. To visualize this, consider
 * the case of the Saturation block feeding an Integrator block.
 *
 * To implement this rule, the mode vector is used to specify the
 * valid equation based on the following:
 *
 * if                UpperLimit < u   then use (1)
 * if LowerLimit <= u <= UpperLimit   then use (2)
 * if u < LowerLimit                  then use (3)
 *
 * The mode vector is changed only at the beginning of a MajorTimeStep.
 *

```

```

* During a minor time step, the equation specified by the mode vector
* is used without question. Most of the time, the value of u will agree
* with the equation specified by the mode vector. However, sometimes u's
* value will indicate a different equation. Nonetheless, the equation
* specified by the mode vector must be used.
*
* When the mode and u indicate different equations, the corresponding
* calculations are not correct. However, this is not a problem. From
* the ZC function, the solver will know that an equation switch occurred
* in the middle of the last MajorTimeStep. The calculations for that
* time step will be discarded. The ZC function will help the solver
* find the exact instant at which the switch occurred. Using this knowledge,
* the length of the MajorTimeStep will be reduced so that only one equation
* is valid throughout the entire time step.
*/
static void mdlOutputs(SimStruct *S, int_T tid)
{
    InputRealPtrsType uPtrs    = ssGetInputPortRealSignalPtrs(S,0);
    real_T            *y        = ssGetOutputPortRealSignal(S,0);
    int_T             numOutput = ssGetOutputPortWidth(S,0);
    int_T             iOutput;

    /*
     * Set index and increment for input signal, upper limit, and lower limit
     * parameters so that each gives scalar expansion if needed.
     */
    int_T uIdx          = 0;
    int_T uInc          = ( ssGetInputPortWidth(S,0) > 1 );
    const real_T *upperLimit = mxGetPr( P_PAR_UPPER_LIMIT );
    int_T upperLimitInc = ( mxGetNumberOfElements( P_PAR_UPPER_LIMIT ) > 1 );
    const real_T *lowerLimit = mxGetPr( P_PAR_LOWER_LIMIT );
    int_T lowerLimitInc = ( mxGetNumberOfElements( P_PAR_LOWER_LIMIT ) > 1 );

    UNUSED_ARG(tid); /* not used in single tasking mode */

    if (ssGetNumNonsampledZCs(S) == 0) {
        /*
         * This block is being used with a fixed-step solver or it has
         * a noncontinuous sample time, so we always saturate.
         */
    }
}

```

```

for (iOutput = 0; iOutput < numOutput; iOutput++) {
    if (*uPtrs[uIdx] >= *upperLimit) {
        *y++ = *upperLimit;
    } else if (*uPtrs[uIdx] > *lowerLimit) {
        *y++ = *uPtrs[uIdx];
    } else {
        *y++ = *lowerLimit;
    }

    upperLimit += upperLimitInc;
    lowerLimit += lowerLimitInc;
    uIdx      += uInc;
}

} else {
    /*
     * This block is being used with a variable-step solver.
     */
    int_T *mode = ssGetModeVector(S);

    /*
     * Specify indices for each equation.
     */
    enum { UpperLimitEquation, NonLimitEquation, LowerLimitEquation };

    /*
     * Update the Mode Vector ONLY at the beginning of a MajorTimeStep
     */
    if ( ssIsMajorTimeStep(S) ) {
        /*
         * Specify the mode, ie the valid equation for each output scalar.
         */
        for ( iOutput = 0; iOutput < numOutput; iOutput++ ) {
            if ( *uPtrs[uIdx] > *upperLimit ) {
                /*
                 * Upper limit eq is valid.
                 */
                mode[iOutput] = UpperLimitEquation;
            } else if ( *uPtrs[uIdx] < *lowerLimit ) {
                /*

```

```
        * Lower limit eq is valid.
        */
        mode[iOutput] = LowerLimitEquation;
    } else {
        /*
        * Nonlimit eq is valid.
        */
        mode[iOutput] = NonLimitEquation;
    }
    /*
    * Adjust indices to give scalar expansion if needed.
    */
    uIdx      += uInc;
    upperLimit += upperLimitInc;
    lowerLimit += lowerLimitInc;
}

/*
* Reset index to input and limits.
*/
uIdx      = 0;
upperLimit = mxGetPr( P_PAR_UPPER_LIMIT );
lowerLimit = mxGetPr( P_PAR_LOWER_LIMIT );

} /* end IsMajorTimeStep */

/*
* For both MinorTimeSteps and MajorTimeSteps calculate each scalar
* output using the equation specified by the mode vector.
*/
for ( iOutput = 0; iOutput < numOutput; iOutput++ ) {
    if ( mode[iOutput] == UpperLimitEquation ) {
        /*
        * Upper limit eq.
        */
        *y++ = *upperLimit;
    } else if ( mode[iOutput] == LowerLimitEquation ) {
        /*
        * Lower limit eq.
        */

```

```

        *y++ = *lowerLimit;
    } else {
        /*
         * Nonlimit eq.
         */
        *y++ = *uPtrs[uIdx];
    }

    /*
     * Adjust indices to give scalar expansion if needed.
     */
    uIdx      += uInc;
    upperLimit += upperLimitInc;
    lowerLimit += lowerLimitInc;
}
}
} /* end mdlOutputs */

```

The `mdlZeroCrossings` method determines if a zero crossing occurred between the previous and current time step. The method obtains a pointer to the input signal using `ssGetInputPortRealSignalPtrs`. A comparison of this signal's value to the value of the upper and lower saturation limits determines values for the elements of the nonsampled zero-crossing vector. If any element of the nonsampled zero-crossing vector switches from negative to positive, or positive to negative, a zero crossing occurred. In the event of a zero crossing, the Simulink engine modifies the step size and recalculates the outputs to try to locate the exact zero crossing.

```

#define      MDL_ZERO_CROSSINGS
#if defined(MDL_ZERO_CROSSINGS) && (defined(MATLAB_MEX_FILE) || defined(NRT))

/* Function: mdlZeroCrossings =====
 * Abstract:
 * This will only be called if the number of nonsampled zero crossings is
 * greater than 0 which means this block has a continuous sample time and the
 * model is using a variable-step solver.
 *
 * Calculate zero crossing (ZC) signals that help the solver find the
 * exact instants at which equation switches occur:
 *

```

```

*   if                               UpperLimit < u   then use (1)
*   if      LowerLimit <= u <= UpperLimit           then use (2)
*   if      u < LowerLimit                          then use (3)
*
* The key words are help find. There is no choice of a function that will
* direct the solver to the exact instant of the change. The solver will
* track the zero crossing signal and do a bisection style search for the
* exact instant of equation switch.
*
* There is generally one ZC signal for each pair of signals that can
* switch. The three equations above would break into two pairs (1)&(2)
* and (2)&(3). The possibility of a "long jump" from (1) to (3) does
* not need to be handled as a separate case. It is implicitly handled.
*
* When ZCs are calculated, the value is normally used twice. When it is
* first calculated, it is used as the end of the current time step. Later,
* it will be used as the beginning of the following step.
*
* The sign of the ZC signal always indicates an equation from the pair. For
* S-functions, which equation is associated with a positive ZC and which is
* associated with a negative ZC doesn't really matter. If the ZC is positive
* at the beginning and at the end of the time step, this implies that the
* "positive" equation was valid throughout the time step. Likewise, if the
* ZC is negative at the beginning and at the end of the time step, this
* implies that the "negative" equation was valid throughout the time step.
* Like any other nonlinear solver, this is not foolproof, but it is an
* excellent indicator. If the ZC has a different sign at the beginning and
* at the end of the time step, then a equation switch definitely occurred
* during the time step.
*
* Ideally, the ZC signal gives an estimate of when an equation switch
* occurred. For example, if the ZC signal is -2 at the beginning and +6 at
* the end, then this suggests that the switch occurred
*  $25\% = 100\% \cdot (-2) / (-2 - (+6))$  of the way into the time step. It will almost
* never be true that 25% is perfectly correct. There is no perfect choice
* for a ZC signal, but there are some good rules. First, choose the ZC
* signal to be continuous. Second, choose the ZC signal to give a monotonic
* measure of the "distance" to a signal switch; strictly monotonic is ideal.
*/
static void mdlZeroCrossings(SimStruct *S)

```

```

{
    int_T          iOutput;
    int_T          numOutput = ssGetOutputPortWidth(S,0);
    real_T         *zcSignals = ssGetNonsampledZCs(S);
    InputRealPtrsType uPtrs    = ssGetInputPortRealSignalPtrs(S,0);

    /*
     * Set index and increment for the input signal, upper limit, and lower
     * limit parameters so that each gives scalar expansion if needed.
     */
    int_T uIdx      = 0;
    int_T uInc      = ( ssGetInputPortWidth(S,0) > 1 );
    real_T *upperLimit = mxGetPr( P_PAR_UPPER_LIMIT );
    int_T upperLimitInc = ( mxGetNumberOfElements( P_PAR_UPPER_LIMIT ) > 1 );
    real_T *lowerLimit = mxGetPr( P_PAR_LOWER_LIMIT );
    int_T lowerLimitInc = ( mxGetNumberOfElements( P_PAR_LOWER_LIMIT ) > 1 );

    /*
     * For each output scalar, give the solver a measure of "how close things
     * are" to an equation switch.
     */
    for ( iOutput = 0; iOutput < numOutput; iOutput++ ) {

        /* The switch from eq (1) to eq (2)
         *
         *   if                UpperLimit < u    then use (1)
         *   if      LowerLimit <= u <= UpperLimit    then use (2)
         *
         * is related to how close u is to UpperLimit. A ZC choice
         * that is continuous, strictly monotonic, and is
         *   u - UpperLimit
         * or it is negative.
         */
        zcSignals[2*iOutput] = *uPtrs[uIdx] - *upperLimit;

        /* The switch from eq (2) to eq (3)
         *
         *   if      LowerLimit <= u <= UpperLimit    then use (2)
         *   if    u < LowerLimit                      then use (3)
         *
         */
    }
}

```

```

        * is related to how close u is to LowerLimit. A ZC choice
        * that is continuous, strictly monotonic, and is
        *   u - LowerLimit.
        */
zcSignals[2*iOutput+1] = *uPtrs[uIdx] - *lowerLimit;

    /*
     * Adjust indices to give scalar expansion if needed.
     */
    uIdx      += uInc;
    upperLimit += upperLimitInc;
    lowerLimit += lowerLimitInc;
}
}

#endif /* end mdlZeroCrossings */

```

The S-function concludes with the required `mdlTerminate` function. In this example, the function is empty.

```

/* Function: mdlTerminate =====
 * Abstract:
 *   No termination needed, but we are required to have this routine.
 */
static void mdlTerminate(SimStruct *S)
{
    UNUSED_ARG(S); /* unused input argument */
}

```

The required S-function trailer includes the files necessary for simulation or code generation, as follows.

```

#ifdef MATLAB_MEX_FILE /* Is this file being compiled as a MEX file? */
#include "simulink.c" /* MEX file interface mechanism */
#else
#include "cg_sfuns.h" /* Code generation registration function */
#endif

```

Note The `mdlOutputs` and `mdlTerminate` functions use the `UNUSED_ARG` macro to indicate that an input argument the callback requires is not used. This optional macro is defined in `simstruc_types.h`. If used, you must call this macro once for each input argument that a callback does not use.

Discontinuities in Continuous States

The example S-function `stvctf.c` demonstrates a time-varying continuous transfer function. The following Simulink model uses this S-function.

`sfcn_demo_stvctf`

The S-function demonstrates how to work with the solvers so that the simulation maintains *consistency*, which means that the block maintains smooth and consistent signals for the integrators although the equations that are being integrated are changing.

`matlabroot/simulink/src/stvctf.c`

The S-function begins with `#define` statements for the S-function name and level, along with a `#include` statement for the `simstruc.h` header. After these statements, the S-function includes or defines any other necessary headers, data, etc. This example defines parameters for the transfer function's numerator and denominator, which are entered into the S-function dialog. The comments at the beginning of this S-function provide additional information on the purpose of the work vectors in this example.

```

/*
 * File : stvctf.c
 * Abstract:
 *     Time Varying Continuous Transfer Function block
 *
 *     This S-function implements a continuous time transfer function
 *     whose transfer function polynomials are passed in via the input
 *     vector. This is useful for continuous time adaptive control
 *     applications.
 *
 *     This S-function is also an example of how to use banks to avoid
 *     problems with computing derivatives when a continuous output has

```

```
* discontinuities. The consistency checker can be used to verify that
* your S-function is correct with respect to always maintaining smooth
* and consistent signals for the integrators. By consistent we mean that
* two mdlOutputs calls at major time t and minor time t are always the
* same. The consistency checker is enabled on the diagnostics page of the
* Configuraion parameters dialog box. The update method of this S-function
* modifies the coefficients of the transfer function, which cause the
* output to "jump." To have the simulation work properly, we need to let
* the solver know of these discontinuities by setting
* ssSetSolverNeedsReset and then we need to use multiple banks of
* coefficients so the coefficients used in the major time step output
* and the minor time step outputs are the same. In the simulation loop
* we have:
*   Loop:
*     o Output in major time step at time t
*     o Update in major time step at time t
*     o Integrate (minor time step):
*       o Consistency check: recompute outputs at time t and compare
*         with current outputs.
*       o Derivatives at time t
*       o One or more Output,Derivative evaluations at time t+k
*         where k <= step_size to be taken.
*       o Compute state, x
*       o t = t + step_size
*     End_Integrate
*   End_Loop
* Another purpose of the consistency checker is to verify that when
* the solver needs to try a smaller step_size, the recomputing of
* the output and derivatives at time t doesn't change. Step size
* reduction occurs when tolerances aren't met for the current step size.
* The ideal ordering would be to update after integrate. To achieve
* this we have two banks of coefficients. And the use of the new
* coefficients, which were computed in update, is delayed until after
* the integrate phase is complete.
*
* This block has multiple sample times and will not work correctly
* in a multitasking environment. It is designed to be used in
* a single tasking (or variable step) simulation environment.
* Because this block accesses the input signal in both tasks,
* it cannot specify the sample times of the input and output ports
```

```

* (SS_OPTION_PORT_SAMPLE_TIMES_ASSIGNED).
*
* See simulink/src/sfuntmpl_doc.c.
*
* Copyright 1990-7 The MathWorks, Inc.
*/

#define S_FUNCTION_NAME stvctf
#define S_FUNCTION_LEVEL 2

#include "simstruc.h"

/*
 * Defines for easy access to the numerator and denominator polynomials
 * parameters
 */
#define NUM(S)  ssGetSFcnParam(S, 0)
#define DEN(S)  ssGetSFcnParam(S, 1)
#define TS(S)   ssGetSFcnParam(S, 2)
#define NPARAMS 3

```

This S-function implements the `mdlCheckParameters` method to check the validity of the S-function dialog parameters. Because this method is optional, a `#define` statement precedes it. The `#if defined` statement checks that this function is compiled as a MEX file, instead of for use with the Simulink Coder product. The body of the function performs basic checks to ensure that the user entered real vectors for the numerator and denominator, and that the denominator has a higher order than the numerator. If the parameter check fails, the S-function errors out.

```

#define MDL_CHECK_PARAMETERS
#if defined(MDL_CHECK_PARAMETERS) && defined(MATLAB_MEX_FILE)
/* Function: mdlCheckParameters =====
 * Abstract:
 *   Validate our parameters to verify:
 *   o The numerator must be of a lower order than the denominator.
 *   o The sample time must be a real positive nonzero value.
 */
static void mdlCheckParameters(SimStruct *S)
{

```

```

int_T i;

for (i = 0; i < NPARAMS; i++) {
    real_T *pr;
    int_T el;
    int_T nEls;
    if (mxIsEmpty( ssGetSFcnParam(S,i) ||
        mxIsSparse( ssGetSFcnParam(S,i) ||
        mxIsComplex( ssGetSFcnParam(S,i) ||
        !mxIsNumeric( ssGetSFcnParam(S,i) ) ) {
        ssSetErrorStatus(S,"Parameters must be real finite vectors");
        return;
    }
    pr = mxGetPr(ssGetSFcnParam(S,i));
    nEls = mxGetNumberOfElements(ssGetSFcnParam(S,i));
    for (el = 0; el < nEls; el++) {
        if (!mxIsFinite(pr[el])) {
            ssSetErrorStatus(S,"Parameters must be real finite vectors");
            return;
        }
    }
}

if (mxGetNumberOfElements(NUM(S)) > mxGetNumberOfElements(DEN(S)) &&
    mxGetNumberOfElements(DEN(S)) > 0 && *mxGetPr(DEN(S)) != 0.0) {
    ssSetErrorStatus(S,"The denominator must be of higher order than "
        "the numerator, nonempty and with first "
        "element nonzero");

    return;
}

/* xxx verify finite */
if (mxGetNumberOfElements(TS(S)) != 1 || mxGetPr(TS(S))[0] <= 0.0) {
    ssSetErrorStatus(S,"Invalid sample time specified");
    return;
}
}
#endif /* MDL_CHECK_PARAMETERS */

```

The required S-function method `mdlInitializeSizes` then sets up the following S-function characteristics.

- `ssSetNumSFcnParams` sets the number of expected S-function dialog parameters to three, as defined previously in the variable `NPARAMS`.
- If this method is compiled as a MEX file, `ssGetSFcnParamsCount` determines how many parameters the user entered into the S-function dialog. If the number of user-specified parameters matches the number returned by `ssGetNumSFcnParams`, the method calls `mdlCheckParameters` to check the validity of the user-entered data. Otherwise, the S-function errors out.
- If the parameter check passes, the S-function specifies the number of continuous and discrete states using `ssSetNumContStates` and `ssSetNumDiscStates`, respectively. This example has no discrete states and sets the number of continuous states based on the number of coefficients in the transfer function's denominator.
- Next, `ssSetNumInputPorts` specifies that the S-function has a single input port and sets its width to one plus twice the length of the denominator using `ssSetInputPortWidth`. The method uses the value provided by the third S-function dialog parameter as the input port's sample time. This parameter indicates the rate at which the transfer function is modified during simulation. The S-function specifies that the input port has direct feedthrough by passing a value of 1 to `ssSetInputPortDirectFeedThrough`.
- `ssSetNumOutputPorts` specifies that the S-function has a single output port. The method uses `ssSetOutputPortWidth` to set the width of this output port, `ssSetOutputPortSampleTime` to specify that the output port has a continuous sample time, and `ssSetOutputPortOffsetTime` to set the offset time to zero.
- `ssSetNumSampleTimes` then initializes two sample times, which the `mdlInitializeSampleTimes` function configures later.
- The method passes a value of four times the number of denominator coefficients to `ssSetNumRWork` in order to set the length of the floating-point work vector. `ssSetNumIWork` then sets the length of the integer work vector to two. The `RWork` vectors store two banks of transfer function coefficients, while the `IWork` vector indicates which bank in the `RWork` vector is currently in use. The S-function sets the length of all other work vectors to zero. You can omit these lines because zero is the default value for these macros. However, for clarity, the S-function explicitly sets the number of work vectors.

- Lastly, `ssSetOptions` sets any applicable options. In this case, `SS_OPTION_EXCEPTION_FREE_CODE` stipulates that the code is exception free.

The `mdlInitializeSizes` function for this example is shown below.

```
/* Function: mdlInitializeSizes =====
 * Abstract:
 *   Determine the S-function block's characteristics:
 *   number of inputs, outputs, states, etc.
 */
static void mdlInitializeSizes(SimStruct *S)
{
    int_T nContStates;
    int_T nCoeffs;

    /* See sfuntmpl_doc.c for more details on the macros below. */

    ssSetNumSFcnParams(S, NPARAMS); /* Number of expected parameters. */
#ifdef MATLAB_MEX_FILE
    if (ssGetNumSFcnParams(S) == ssGetSFcnParamsCount(S)) {
        mdlCheckParameters(S);
        if (ssGetErrorStatus(S) != NULL) {
            return;
        }
    } else {
        return; /* Parameter mismatch reported by the Simulink engine*/
    }
#endif

    /*
     * Define the characteristics of the block:
     *
     * Number of continuous states:    length of denominator - 1
     * Inputs port width               2 * (NumContStates+1) + 1
     * Output port width               1
     * DirectFeedThrough:              0 (Although this should be computed.
     *                                 We'll assume coefficients entered
     *                                 are strictly proper).
     */
}
```

```

*   Number of sample times:           2 (continuous and discrete)
*   Number of Real work elements:     4*NumCoeffs
*                                     (Two banks for num and den coeff's:
*                                     NumBank0Coeffs
*                                     DenBank0Coeffs
*                                     NumBank1Coeffs
*                                     DenBank1Coeffs)
*   Number of Integer work elements:  2 (indicator of active bank 0 or 1
*                                     and flag to indicate when banks
*                                     have been updated).
*
* The number of inputs arises from the following:
*   o 1 input (u)
*   o the numerator and denominator polynomials each have NumContStates+1
*     coefficients
*/
nCoeffs      = mxGetNumberOfElements(DEN(S));
nContStates = nCoeffs - 1;

ssSetNumContStates(S, nContStates);
ssSetNumDiscStates(S, 0);

if (!ssSetNumInputPorts(S, 1)) return;
ssSetInputPortWidth(S, 0, 1 + (2*nCoeffs));
ssSetInputPortDirectFeedThrough(S, 0, 0);
ssSetInputPortSampleTime(S, 0, mxGetPr(TS(S))[0]);
ssSetInputPortOffsetTime(S, 0, 0);

if (!ssSetNumOutputPorts(S,1)) return;
ssSetOutputPortWidth(S, 0, 1);
ssSetOutputPortSampleTime(S, 0, CONTINUOUS_SAMPLE_TIME);
ssSetOutputPortOffsetTime(S, 0, 0);

ssSetNumSampleTimes(S, 2);

ssSetNumRWork(S, 4 * nCoeffs);
ssSetNumIWork(S, 2);
ssSetNumPWork(S, 0);

ssSetNumModes(S, 0);

```

```
    ssSetNumNonsampledZCs(S, 0);

    /* Take care when specifying exception free code - see sfuntmpl_doc.c */
    ssSetOptions(S, (SS_OPTION_EXCEPTION_FREE_CODE));

} /* end mdlInitializeSizes */
```

The required S-function method `mdlInitializeSampleTimes` specifies the S-function sample rates. The first call to `ssSetSampleTime` specifies that the first sample rate is continuous and the subsequent call to `ssSetOffsetTime` sets the offset to zero. The second call to this pair of macros sets the second sample time to the value of the third S-function parameter with an offset of zero. The call to `ssSetModelReferenceSampleTimeDefaultInheritance` tells the solver to use the default rule to determine if submodels containing this S-function can inherit their sample times from the parent model.

```
/* Function: mdlInitializeSampleTimes =====
 * Abstract:
 *   This function is used to specify the sample time(s) for the
 *   S-function. This S-function has two sample times. The
 *   first, a continuous sample time, is used for the input to the
 *   transfer function, u. The second, a discrete sample time
 *   provided by the user, defines the rate at which the transfer
 *   function coefficients are updated.
 */
static void mdlInitializeSampleTimes(SimStruct *S)
{
    /*
     * the first sample time, continuous
     */
    ssSetSampleTime(S, 0, CONTINUOUS_SAMPLE_TIME);
    ssSetOffsetTime(S, 0, 0.0);

    /*
     * the second, discrete sample time, is user provided
     */
    ssSetSampleTime(S, 1, mxGetPr(TS(S))[0]);
    ssSetOffsetTime(S, 1, 0.0);
    ssSetModelReferenceSampleTimeDefaultInheritance(S);
}
```



```
} /* end mdlInitializeSampleTimes */
```

The optional S-function method `mdlInitializeConditions` initializes the continuous state vector and the initial numerator and denominator vectors. The `#define` statement before this method is required for the Simulink engine to call this function. The function initializes the continuous states to zero. The numerator and denominator coefficients are initialized from the first two S-function parameters, normalized by the first denominator coefficient. The function sets the value stored in the `IWork` vector to zero, to indicate that the first bank of numerator and denominator coefficients stored in the `RWork` vector is currently in use.

```
#define MDL_INITIALIZE_CONDITIONS
/* Function: mdlInitializeConditions =====
 * Abstract:
 *      Initialize the states, numerator and denominator coefficients.
 */
static void mdlInitializeConditions(SimStruct *S)
{
    int_T i;
    int_T nContStates = ssGetNumContStates(S);
    real_T *x0        = ssGetContStates(S);
    int_T nCoeffs     = nContStates + 1;
    real_T *numBank0  = ssGetRWork(S);
    real_T *denBank0  = numBank0 + nCoeffs;
    int_T *activeBank = ssGetIWork(S);

    /*
     * The continuous states are all initialized to zero.
     */
    for (i = 0; i < nContStates; i++) {
        x0[i] = 0.0;
        numBank0[i] = 0.0;
        denBank0[i] = 0.0;
    }
    numBank0[nContStates] = 0.0;
    denBank0[nContStates] = 0.0;

    /*
```

```

    * Set up the initial numerator and denominator.
    */
    {
        const real_T *numParam = mxGetPr(NUM(S));
        int          numParamLen = mxGetNumberOfElements(NUM(S));

        const real_T *denParam = mxGetPr(DEN(S));
        int          denParamLen = mxGetNumberOfElements(DEN(S));
        real_T       den0       = denParam[0];

        for (i = 0; i < denParamLen; i++) {
            denBank0[i] = denParam[i] / den0;
        }

        for (i = 0; i < numParamLen; i++) {
            numBank0[i] = numParam[i] / den0;
        }
    }

    /*
    * Normalize if this transfer function has direct feedthrough.
    */
    for (i = 1; i < nCoeffs; i++) {
        numBank0[i] -= denBank0[i]*numBank0[0];
    }

    /*
    * Indicate bank0 is active (i.e. bank1 is oldest).
    */
    *activeBank = 0;
} /* end mdlInitializeConditions */

```

The `mdlOutputs` function calculates the S-function output signals when the S-function is simulating in a continuous task, i.e., `ssIsContinuousTask` is true. If the simulation is also at a major time step, `mdlOutputs` checks if the numerator and denominator coefficients need to be updated, as indicated by a switch in the active bank stored in the `IWork` vector. At both major and minor time steps, the S-function calculates the output using the numerator coefficients stored in the active bank.

```

/* Function: mdlOutputs =====
 * Abstract:
 *     The outputs for this block are computed by using a controllable state-
 *     space representation of the transfer function.
 */
static void mdlOutputs(SimStruct *S, int_T tid)
{
    if (ssIsContinuousTask(S,tid)) {
        int            i;
        real_T         *num;
        int            nContStates = ssGetNumContStates(S);
        real_T         *x          = ssGetContStates(S);
        int_T          nCoeffs    = nContStates + 1;
        InputRealPtrsType uPtrs    = ssGetInputPortRealSignalPtrs(S,0);
        real_T         *y          = ssGetOutputPortRealSignal(S,0);
        int_T          *activeBank = ssGetIWork(S);

        /*
         * Switch banks because we've updated them in mdlUpdate and we're no
         * longer in a minor time step.
         */
        if (ssIsMajorTimeStep(S)) {
            int_T *banksUpdated = ssGetIWork(S) + 1;
            if (*banksUpdated) {
                *activeBank = !(*activeBank);
                *banksUpdated = 0;
            }
            /*
             * Need to tell the solvers that the derivatives are no
             * longer valid.
             */
            ssSetSolverNeedsReset(S);
        }
    }
    num = ssGetRWork(S) + (*activeBank) * (2*nCoeffs);

    /*
     * The continuous system is evaluated using a controllable state space
     * representation of the transfer function. This implies that the
     * output of the system is equal to:
     */
}

```

```

*      y(t) = Cx(t) + Du(t)
*          = [ b1 b2 ... bn]x(t) + b0u(t)
*
* where b0, b1, b2, ... are the coefficients of the numerator
* polynomial:
*
*      B(s) = b0 s^n + b1 s^{n-1} + b2 s^{n-2} + ... + bn-1 s + bn
*/
*y = *num++ * (*uPtrs[0]);
for (i = 0; i < nContStates; i++) {
    *y += *num++ * *x++;
}
}

} /* end mdlOutputs */

```

Although this example has no discrete states, the method still implements the `mdlUpdate` function to update the transfer function coefficients at every major time step. Because this method is optional, a `#define` statement precedes it. The method uses `ssGetInputPortRealSignalPtrs` to obtain a pointer to the input signal. The input signal's values become the new transfer function coefficients, which the S-function stores in the bank of the inactive `RWork` vector. When the `mdlOutputs` function is later called at this major time step, it updates the active bank to be this updated bank of coefficients.

```

#define MDL_UPDATE
/* Function: mdlUpdate =====
* Abstract:
*      Every time through the simulation loop, update the
*      transfer function coefficients. Here we update the oldest bank.
*/
static void mdlUpdate(SimStruct *S, int_T tid)
{
    if (ssIsSampleHit(S, 1, tid)) {
        int_T          i;
        InputRealPtrsType uPtrs      = ssGetInputPortRealSignalPtrs(S,0);
        int_T          uIdx          = 1; /*1st coeff is after signal input*/
        int_T          nContStates   = ssGetNumContStates(S);
        int_T          nCoeffs       = nContStates + 1;
        int_T          bankToUpdate  = !ssGetIWork(S)[0];
    }
}

```

```

real_T      *num      = ssGetRWork(S)+bankToUpdate*2*nCoeffs;
real_T      *den      = num + nCoeffs;

real_T      den0;
int_T       allZero;

/*
 * Get the first denominator coefficient. It will be used
 * for normalizing the numerator and denominator coefficients.
 *
 * If all inputs are zero, we probably could have unconnected
 * inputs, so use the parameter as the first denominator coefficient.
 */
den0 = *uPtrs[uIdx+nCoeffs];
if (den0 == 0.0) {
    den0 = mxGetPr(DEN(S))[0];
}

/*
 * Grab the numerator.
 */
allZero = 1;
for (i = 0; (i < nCoeffs) && allZero; i++) {
    allZero &= *uPtrs[uIdx+i] == 0.0;
}

if (allZero) { /* if numerator is all zero */
    const real_T *numParam = mxGetPr(NUM(S));
    int_T        numParamLen = mxGetNumberOfElements(NUM(S));
    /*
     * Move the input to the denominator input and
     * get the denominator from the input parameter.
     */
    uIdx += nCoeffs;
    num += nCoeffs - numParamLen;
    for (i = 0; i < numParamLen; i++) {
        *num++ = *numParam++ / den0;
    }
} else {

```

```

        for (i = 0; i < nCoeffs; i++) {
            *num++ = *uPtrs[uIdx++] / den0;
        }
    }

    /*
     * Grab the denominator.
     */
    allZero = 1;
    for (i = 0; (i < nCoeffs) && allZero; i++) {
        allZero &= *uPtrs[uIdx+i] == 0.0;
    }

    if (allZero) { /* If denominator is all zero. */
        const real_T *denParam = mxGetPr(DEN(S));
        int_T denParamLen = mxGetNumberOfElements(DEN(S));

        den0 = denParam[0];
        for (i = 0; i < denParamLen; i++) {
            *den++ = *denParam++ / den0;
        }
    } else {
        for (i = 0; i < nCoeffs; i++) {
            *den++ = *uPtrs[uIdx++] / den0;
        }
    }

    /*
     * Normalize if this transfer function has direct feedthrough.
     */
    num = ssGetRWork(S) + bankToUpdate*2*nCoeffs;
    den = num + nCoeffs;
    for (i = 1; i < nCoeffs; i++) {
        num[i] -= den[i]*num[0];
    }

    /*
     * Indicate oldest bank has been updated.
     */
    ssGetIWork(S)[1] = 1;

```

```

    }

} /* end mdlUpdate */

```

The `mdlDerivatives` function calculates the continuous state derivatives. The function uses the coefficients from the active bank to solve a controllable state-space representation of the transfer function.

```

#define MDL_DERIVATIVES
/* Function: mdlDerivatives =====
 * Abstract:
 *     The derivatives for this block are computed by using a controllable
 *     state-space representation of the transfer function.
 */
static void mdlDerivatives(SimStruct *S)
{
    int_T          i;
    int_T          nContStates = ssGetNumContStates(S);
    real_T         *x          = ssGetContStates(S);
    real_T         *dx         = ssGetdX(S);
    int_T          nCoeffs     = nContStates + 1;
    int_T          activeBank  = ssGetIWork(S)[0];
    const real_T   *num        = ssGetRWork(S) + activeBank*(2*nCoeffs);
    const real_T   *den        = num + nCoeffs;
    InputRealPtrsType uPtrs    = ssGetInputPortRealSignalPtrs(S,0);

    /*
     * The continuous system is evaluated using a controllable state-space
     * representation of the transfer function. This implies that the
     * next continuous states are computed using:
     *
     *     dx = Ax(t) + Bu(t)
     *     = [-a1 -a2 ... -an] [x1(t)] + [u(t)]
     *       [ 1  0 ...  0] [x2(t)] + [0]
     *       [ 0  1 ...  0] [x3(t)] + [0]
     *       [ .  . ...  .]  .      + .
     *       [ .  . ...  .]  .      + .
     *       [ .  . ...  .]  .      + .
     *       [ 0  0 ...  1 0] [xn(t)] + [0]
     */
}

```

```

    * where a1, a2, ... are the coefficients of the numerator polynomial:
    *
    *   A(s) = s^n + a1 s^{n-1} + a2 s^{n-2} + ... + an-1 s + an
    */
    dx[0] = -den[1] * x[0] + *uPtrs[0];
    for (i = 1; i < nContStates; i++) {
        dx[i] = x[i-1];
        dx[0] -= den[i+1] * x[i];
    }
} /* end mdlDerivatives */

```

The required `mdlTerminate` function performs any actions, such as freeing memory, necessary at the end of the simulation. In this example, the function is empty.

```

/* Function: mdlTerminate =====
 * Abstract:
 *   Called when the simulation is terminated.
 *   For this block, there are no end of simulation tasks.
 */
static void mdlTerminate(SimStruct *S)
{
    UNUSED_ARG(S); /* unused input argument */
} /* end mdlTerminate */

```

The required S-function trailer includes the files necessary for simulation or code generation, as follows.

```

#ifdef MATLAB_MEX_FILE /* Is this file being compiled as a MEX file? */
#include "simulink.c" /* MEX file interface mechanism */
#else
#include "cg_sfund.h" /* Code generation registration function */
#endif

```

Note The `mdlTerminate` function uses the `UNUSED_ARG` macro to indicate that an input argument the callback requires is not used. This optional macro is defined in `simstruc_types.h`. If used, you must call this macro once for each input argument that a callback does not use.

S-Function Callback Methods — Alphabetical List

Every user-written S-function must implement a set of methods, called *callback methods* or simply *callbacks*, that the Simulink engine invokes when simulating a model that contains the S-function. Some callback methods are optional. The engine invokes an optional callback only if the S-function defines the callback. This topic describes the purpose and syntax of all callback methods that an S-function can implement. In each case, the documentation for a callback method indicates whether it is required or optional. For a list of required callback methods, see “Callback Methods That an S-Function Must Implement” on page 4-52.

CheckParameters

Purpose	Check the validity of a MATLAB S-Function's parameters
Required	No
Language	MATLAB
Syntax	CheckParameters(s)
Arguments	s Instance of Simulink.MSFcnRunTimeBlock class representing a Level-2 MATLAB S-Function block.
Description	<p>Verifies new parameter settings whenever parameters change or are reevaluated during a simulation.</p> <p>When a simulation is running, changes to S-function parameters can occur at any time during the simulation loop, that is, either at the start of a simulation step or during a simulation step. When the change occurs during a simulation step, the Simulink engine calls this routine twice to handle the parameter change. The first call during the simulation step is used to verify that the parameters are correct. After verifying the new parameters, the simulation continues using the original parameter values until the next simulation step, at which time the new parameter values are used. Redundant calls are needed to maintain simulation consistency.</p>

Note You cannot access the work, state, input, output, and other vectors in this routine. Use this routine only to validate the parameters. Additional processing of the parameters should be done in `ProcessParameters`.

Example In a Level-2 MATLAB S-function, the `setup` method registers the `CheckParameters` method as follows

```
s.RegBlockMethod('CheckParameters', @CheckParam);
```

The local function `CheckParam` then verifies the S-function parameters. In this example, the function checks that the second parameter, an upper limit value, is greater than the first S-function parameter, a lower limit value.

```
function CheckParam(s)

% Check that upper limit is greater than lower limit
lowerLim = s.DialogPrm(1).Data;
upperLim = s.DialogPrm(2).Data;

if upperLim <= lowerLim,
    error('The upper limit must be greater than the lower limit.');
```

See Also

`ProcessParameters`, `Simulink.RunTimeBlock`,
`Simulink.MSFcnRunTimeBlock`, `mdlCheckParameters`

Derivatives

Purpose	Compute a MATLAB S-Function's derivatives
Required	No
Language	MATLAB
Syntax	<code>Derivatives(s)</code>
Arguments	<code>s</code> Instance of <code>Simulink.MSFcnRunTimeBlock</code> class representing the Level-2 MATLAB S-Function block
Description	<p>The Simulink engine invokes this optional method at each time step to compute the derivatives of the S-function's continuous states. This method should store the derivatives in the S-function's state derivatives vector. In a Level-2 MATLAB S-function, use the run-time object's <code>Derivatives</code> method.</p> <p>Each time the <code>Derivatives</code> routine is called, it must explicitly set the values of all derivatives. The derivative vector does not maintain the values from the last call to this routine. The memory allocated to the derivative vector changes during execution.</p>
Example	For a Level-2 MATLAB S-function example, see <code>msfcn_limintm.m</code> .
See Also	<code>Simulink.RunTimeBlock</code> , <code>Simulink.MSFcnRunTimeBlock</code> , <code>mdlDerivatives</code>

Purpose	Respond to disabling of an enabled system containing this MATLAB S-Function block
Required	No
Language	MATLAB
Syntax	Disable(s)
Arguments	s Instance of Simulink.MSFcnRunTimeBlock class representing the Level-2 MATLAB S-Function block.
Description	The Simulink engine invokes this optional method if this block resides in an enabled subsystem and the enabled subsystem changes from an enabled to a disabled state at the current time step. Your S-function can use this method to perform any actions required by the disabling of the containing subsystem.
See Also	Enable, Simulink.MSFcnRunTimeBlock, mdlDisable

Enable

Purpose	Respond to enabling of an enabled system containing this MATLAB S-Function block
Required	No
Language	MATLAB
Syntax	Enable(s)
Arguments	s Instance of Simulink.MSFcnRunTimeBlock class representing the Level-2 MATLAB S-Function block.
Description	The Simulink engine invokes this optional method if this block resides in an enabled subsystem and the enabled subsystem changes from a disabled to an enabled state at the current time step. Your S-function can use this method to perform any actions required by the enabling of the containing subsystem.
See Also	Disable, Simulink.MSFcnRunTimeBlock, mdlEnable

Purpose	Return the MATLAB S-function simulation state as a valid MATLAB data structure, such as a matrix structure or a cell array.
Required	No
Language	MATLAB
Syntax	<code>GetSimState(s)</code>
Arguments	<p><code>s</code></p> <p>Instance of <code>Simulink.MSFcnRunTimeBlock</code> class representing the Level-2 MATLAB S-Function block.</p>
Description	The Simulink engine invokes this custom method to get the simulation state (<code>SimState</code>) of the model containing <code>S</code> . A call to this method should occur after <code>Start</code> and before <code>Terminate</code> to ensure that all of the S-function data structures (e.g., states, <code>DWork</code> vectors, and outputs) are available.
See Also	<code>SetSimState</code> , <code>Simulink.MSFcnRunTimeBlock</code> , <code>mdlGetSimState</code>

InitializeConditions

Purpose	Initialize the state vectors of this MATLAB S-function
Required	No
Language	MATLAB
Syntax	<code>InitializeConditions(s)</code>
Arguments	<code>s</code> Instance of <code>Simulink.MSFcnRunTimeBlock</code> class representing the Level-2 MATLAB S-Function block.
Description	The Simulink engine invokes this optional method at the beginning of a simulation. It should initialize the continuous and discrete states, if any, of this S-Function block. In a Level-2 MATLAB S-function, use the <code>ContStates</code> or <code>Dwork</code> run-time object methods to access the continuous and discrete states. This method can also perform any other initialization activities that this S-function requires.

Note If you have Simulink Coder, and you need to ensure that the initialization code in the `InitializeConditions` function is run only once, then move this initialization code into the `Start` method. MathWorks recommends this code change as a best practice.

If this S-function resides in an enabled subsystem configured to reset states, the Simulink engine also calls this method when the enabled subsystem restarts execution.

The Simulink engine calls `InitializeConditions` prior to calculating the S-function's input signals. Therefore, since the input signal values are not yet available, `InitializeConditions` should not use the input signal values to set initial conditions. If your S-function needs to initialize internal values using the block's input signals, perform the initialization in `Outputs`.

For example, in a C MEX S-function, initializes an IWork vector with one element in the mdlInitializeSizes method.

```
ssSetNumIWork(S, 1);
```

The IWork vector holds a flag indicating if initial values have been specified. Initialize the flag's value in the mdlInitializeCondition method.

```
static void mdlInitializeConditions(SimStruct *S)
{
    /* The mdlInitializeConditions method is called when the simulation
       start and every time an enabled subsystem is re-enabled.

       Reset the IWork flag to 1 when values need to be reinitialized.*/

    ssSetIWorkValue(S, 0, 1);
}
```

Check the value of the IWork vector flag in the mdlOutputs method, to determine if initial values need to be set. Since the engine has calculated input values at this point in the simulation, the mdlOutputs method can use them to initialize internal values.

```
static void mdlOutputs(SimStruct *S, int_T tid)
{
    // Initialize values if the IWork vector flag is true. //
    if (ssGetIWorkValue(S, 0) == 1) {
        // Enter initialization code here //
    }

    // Remainder of mdlOutputs function //
}
```

For a Level-2 MATLAB S-function, use a DWork vector instead of an IWork vector in the previous example.

InitializeConditions

Example

This example initializes both a continuous and discrete state to 1.0. Level-2 MATLAB S-functions store discrete states in their DWork vectors.

```
function InitializeConditions(s)

s.ContStates.Data(1) = 1;
s.Dwork(1).Data      = 1;

% endfunction
```

See Also

Start, Outputs, Simulink.RunTimeBlock,
Simulink.MSFcnRunTimeBlock, mdlInitializeConditions

Purpose	Check the validity of a C MEX S-function's parameters
Required	No
Languages	C, C++
Syntax	<pre>#define MDL_CHECK_PARAMETERS void mdlCheckParameters(SimStruct *S)</pre>
Arguments	S SimStruct representing an S-Function block.
Description	<p>Verifies new parameter settings whenever parameters change or are reevaluated during a simulation. If you have Simulink Coder, for C MEX S-functions, this method is only valid for simulation, and must be enclosed in a <code>#if defined(MATLAB_MEX_FILE)</code> statement to be compatible with code generation targets that support noninlined S-functions.</p> <p>When a simulation is running, changes to S-function parameters can occur at any time during the simulation loop, that is, either at the start of a simulation step or during a simulation step. When the change occurs during a simulation step, the Simulink engine calls this routine twice to handle the parameter change. The first call during the simulation step is used to verify that the parameters are correct. After verifying the new parameters, the simulation continues using the original parameter values until the next simulation step, at which time the new parameter values are used. Redundant calls are needed to maintain simulation consistency.</p>

Note You cannot access the work, state, input, output, and other vectors in this routine. Use this routine only to validate the parameters. Additional processing of the parameters should be done in `mdlProcessParameters`.

mdlCheckParameters

Example

This example checks the first S-function parameter to verify that it is a real nonnegative scalar.

Note Since `mdlCheckParameters` is an optional method, a `#define MDL_CHECK_PARAMETERS` statement precedes the function. Also, since the Simulink Coder product does not support code generation for `mdlCheckParameters`, the function is wrapped in a `#if defined(MATLAB_MEX_FILE)` statement.

```
#define PARAM1(S) ssGetSFcnParam(S,0)
#define MDL_CHECK_PARAMETERS /* Change to #undef to remove function */
#if defined(MDL_CHECK_PARAMETERS) && defined(MATLAB_MEX_FILE)
static void mdlCheckParameters(SimStruct *S)
{
    if (mxGetNumberOfElements(PARAM1(S)) != 1) {
        ssSetErrorStatus(S, "Parameter to S-function must be a scalar");
        return;
    } else if (mxGetPr(PARAM1(S))[0] < 0) {
        ssSetErrorStatus(S, "Parameter to S-function must be nonnegative");
        return;
    }
}
#endif /* MDL_CHECK_PARAMETERS */
```

In addition to the preceding routine, you must add a call to this method from `mdlInitializeSizes` to check parameters during initialization, because `mdlCheckParameters` is only called while the simulation is running. To do this, after setting the number of parameters you expect in your S-function by using `ssSetNumSFcnParams`, use this code in `mdlInitializeSizes`:

```
static void mdlInitializeSizes(SimStruct *S)
{
    ssSetNumSFcnParams(S, 1); /* Number of expected parameters */
#ifdef MATLAB_MEX_FILE
    if(ssGetNumSFcnParams(S) == ssGetSFcnParamsCount(S) {
        mdlCheckParameters(S);
        if(ssGetErrorStatus(S) != NULL) return;
    } else {
        return; /* The Simulink engine reports a mismatch error. */
    }
#endif
    ...
}
```

Note The macro `ssGetSFcnParamsCount` returns the actual number of parameters entered in the dialog box.

See `sfun_errhdl.c` for an example.

See Also

`mdlProcessParameters`, `ssGetSFcnParamsCount`, `CheckParameters`

mdlDerivatives

Purpose	Compute the C MEX S-function's derivatives
Required	No
Languages	C, C++
Syntax	<pre>#define MDL_DERIVATIVES void mdlDerivatives(SimStruct *S)</pre>
Arguments	S SimStruct representing an S-Function block.
Description	<p>The Simulink engine invokes this optional method at each time step to compute the derivatives of the S-function's continuous states. This method should store the derivatives in the S-function's state derivatives vector. In a C MEX S-function, use <code>ssGetdX</code> to get a pointer to the derivatives vector.</p> <p>Each time the <code>mdlDerivatives</code> routine is called, it must explicitly set the values of all derivatives. The derivative vector does not maintain the values from the last call to this routine. The memory allocated to the derivative vector changes during execution.</p>

Note If you have Simulink Coder, when generating code for a noninlined C MEX S-function that contains this method, make sure the method is not wrapped in a `#if defined(MATLAB_MEX_FILE)` statement. For example:

```
#define MDL_DERIVATIVES
#if defined(MDL_DERIVATIVES) && defined(MATLAB_MEX_FILE)
static void mdlDerivatives(SimStruct *S)
{
    /* Add mdlDerivatives code here */
}
#endif
```

The `define` statement makes the `mdlDerivatives` method available only to a MATLAB MEX file. If the S-function is not inlined, the Simulink Coder product cannot use this method, resulting in link or run-time errors.

Example

For a C MEX S-function example, see `csfunc.c`.

See Also

`ssGetdx`, `Derivatives`

mdlDisable

Purpose	Respond to disabling of an enabled system containing this block
Required	No
Languages	C, C++
Syntax	<pre>#define MDL_DISABLE void mdlDisable(SimStruct *S)</pre>
Arguments	S SimStruct representing an S-Function block.
Description	The Simulink engine invokes this optional method if this block resides in an enabled subsystem and the enabled subsystem changes from an enabled to a disabled state at the current time step. Your S-function can use this method to perform any actions required by the disabling of the containing subsystem.
See Also	mdlEnable, Disable

Purpose	Respond to enabling of a enabled system containing this block
Required	No
Languages	C, C++
Syntax	<pre>#define MDL_ENABLE void mdlEnable(SimStruct *S)</pre>
Arguments	S SimStruct representing an S-Function block.
Description	The Simulink engine invokes this optional method if this block resides in an enabled subsystem and the enabled subsystem changes from a disabled to an enabled state at the current time step. Your S-function can use this method to perform any actions required by the enabling of the containing subsystem.
See Also	mdlDisable, Enable

mdlGetSimState

Purpose Return the C MEX S-function simulation state as a valid MATLAB data structure, such as a matrix structure or a cell array.

Required No

Languages C, C++

Syntax
`#define MDL_SIM_STATE
mxArray* mdlSetSimState(SimStruct* S)`

Arguments S
SimStruct representing an S-Function block.

Description The Simulink engine invokes this custom method to get the simulation state (SimState) of the model containing S. A call to this method should occur after `mdlStart` and before `mdlTerminate` to ensure that all of the S-function data structures (e.g., states, DWork vectors, and outputs) are available.

Example

```
% Function: mdlGetSimState
% Abstract:
% Package the RunTimeData structure as a MATLAB structure
% and return it.
%
static mxArray* mdlGetSimState(SimStruct* S)
{
    int n = ssGetInputPortWidth(S, 0);
    RunTimeData_T* rtd =
        (RunTimeData_T*)ssGetPWorkValue(S, 0);

    /* Create a MATLAB structure to hold the run-time data */
    mxArray* simSnap =
        mxCreateStructMatrix(1, 1, nFields, fieldNames);
    return simSnap;
}
```

See Also mdlSetSimState, GetSimState

mdlGetTimeOfNextVarHit

Purpose Specify time of the next sample time hit

Required No

Languages C, C++

Syntax

```
#define MDL_GET_TIME_OF_NEXT_VAR_HIT  
void mdlGetTimeOfNextVarHit(SimStruct *S)
```

Arguments S
SimStruct representing an S-Function block.

Description The Simulink engine invokes this optional method at every major integration step to get the time of the next sample time hit. This method should set the time of next hit, using `ssSetTNext`. The time of the next hit must be greater than the current simulation time as returned by `ssGetT`. The S-function must implement this method if it operates at a discrete, variable-step sample time.

For Level-2 MATLAB S-functions, use a sample time of -2 to specify a variable sample time. The S-function's output method should then update the `NextTimeHit` property of the instance of the `Simulink.MSFcnRuntimeBlock` class representing the S-Function block to set the time of the next sample time hit. See `/msfcn_vs.m` for an example.

For Level-1 MATLAB S-functions, a flag of 4 is passed to the S-function when the next sample time hit needs to be calculated.

Note The time of the next hit can be a function of the input signals.

Example

```
static void mdlGetTimeOfNextVarHit(SimStruct *S)  
{  
    time_T offset = getOffset();
```

```
time_T timeOfNextHit = ssGetT(S) + offset;  
ssSetTNext(S, timeOfNextHit);  
}
```

See Also

mdlInitializeSampleTimes, ssGetT, ssSetTNext

mdlInitializeConditions

Purpose Initialize the state vectors of this C MEX S-function

Required No

Languages C, C++

Syntax

```
#define MDL_INITIALIZE_CONDITIONS
void mdlInitializeConditions(SimStruct *S)
```

Arguments S
SimStruct representing an S-Function block.

Description The Simulink engine invokes this optional method at the beginning of a simulation. It should initialize the continuous and discrete states, if any, of this S-Function block. In a C MEX S-function, use `ssGetContStates` and/or `ssGetDiscStates` to access the states. This method can also perform any other initialization activities that this S-function requires.

Note If you have Simulink Coder and you need to ensure that the initialization code in the `mdlInitializeConditions` function is run only once, then move this initialization code into the `mdlStart` method. MathWorks recommends this code change as a best practice.

If this S-function resides in an enabled subsystem configured to reset states, the Simulink engine also calls this method when the enabled subsystem restarts execution. C MEX S-functions can use the `ssIsFirstInitCond` macro to determine whether the time at which `mdlInitializeCondition` is called is equal to the simulation start time.

Note If you have Simulink Coder, when generating code for a noninlined C MEX S-function that contains this method, make sure the method is not wrapped in a `#if defined(MATLAB_MEX_FILE)` statement. For example:

```
#define MDL_INITIALIZE_CONDITIONS
#if defined(MDL_INITIALIZE_CONDITIONS) && defined(MATLAB_MEX_FILE)
static void mdlInitializeConditions(SimStruct *S)
{
    /* Add mdlInitializeConditions code here */
}
#endif
```

The `define` statement makes the `mdlInitializeConditions` method available only to a MATLAB MEX file. If the S-function is not inlined, the Simulink Coder product cannot use this method, resulting in link or run-time errors.

The Simulink engine calls `mdlInitializeConditions` prior to calculating the S-function's input signals. Therefore, since the input signal values are not yet available, `mdlInitializeConditions` should not use the input signal values to set initial conditions. If your S-function needs to initialize internal values using the block's input signals, perform the initialization in `mdlOutputs`.

For example, in a C MEX S-function, initializes an `IWork` vector with one element in the `mdlInitializeSizes` method.

```
ssSetNumIWork(S, 1);
```

The `IWork` vector holds a flag indicating if initial values have been specified. Initialize the flag's value in the `mdlInitializeCondition` method.

```
static void mdlInitializeConditions(SimStruct *S)
{
```

mdlInitializeConditions

```
/* The mdlInitializeConditions method is called when the simulation
   start and every time an enabled subsystem is re-enabled.

   Reset the IWork flag to 1 when values need to be reinitialized.*/

ssSetIWorkValue(S, 0, 1);
}
```

Check the value of the IWork vector flag in the mdlOutputs method, to determine if initial values need to be set. Since the engine has calculated input values at this point in the simulation, the mdlOutputs method can use them to initialize internal values.

```
static void mdlOutputs(SimStruct *S, int_T tid)
{
    // Initialize values if the IWork vector flag is true. //
    if (ssGetIWorkValue(S, 0) == 1) {
        // Enter initialization code here //
    }

    // Remainder of mdlOutputs function //
}
```

For a Level-2 MATLAB S-function, use a DWork vector instead of an IWork vector in the previous example.

Example

This example initializes both a continuous and discrete state to 1.0.

```
#define MDL_INITIALIZE_CONDITIONS /*Change to #undef to remove */
                                  /*function*/
#if defined(MDL_INITIALIZE_CONDITIONS)

static void mdlInitializeConditions(SimStruct *S)
{
    int i;
    real_T *xcont = ssGetContStates(S);
    int_T nCStates = ssGetNumContStates(S);
    real_T *xdisc = ssGetRealDiscStates(S);
}
```

```
int_T   nDStates = ssGetNumDiscStates(S);

for (i = 0; i < nCStates; i++) {
    *xcont++ = 1.0;
}

for (i = 0; i < nDStates; i++) {
    *xdisc++ = 1.0;
}

}
#endif /* MDL_INITIALIZE_CONDITIONS */
```

For another example that initializes only the continuous states, see `resetint.c`.

See Also

`mdlStart`, `mdlOutputs`, `ssIsFirstInitCond`, `ssGetContStates`, `ssGetDiscStates`, `ssGetTStart`, `ssGetT`, `InitializeConditions`

mdlInitializeSampleTimes

Purpose	Specify the sample rates at which this C MEX S-function operates
Required	Yes
Languages	C, C++
Syntax	<pre>#define MDL_INITIALIZE_SAMPLE_TIMES void mdlInitializeSampleTimes(SimStruct *S)</pre>
Arguments	<p>S</p> <p>SimStruct representing an S-Function block.</p>
Description	<p>This method should specify the sample time and offset time for each sample rate at which this S-function operates via the following paired macros</p> <pre>ssSetSampleTime(S, sampleTimeIndex, sample_time) ssSetOffsetTime(S, offsetTimeIndex, offset_time)</pre> <p>where <code>sampleTimeIndex</code> runs from 0 to one less than the number of sample times specified in <code>mdlInitializeSizes</code> via <code>ssSetNumSampleTimes</code>.</p> <p>If the S-function operates at one or more sample rates, this method can specify any of the following sample time and offset values for a given sample time:</p> <ul style="list-style-type: none">• [CONTINUOUS_SAMPLE_TIME, 0.0]• [CONTINUOUS_SAMPLE_TIME, FIXED_IN_MINOR_STEP_OFFSET]• [discrete_sample_period, offset]• [VARIABLE_SAMPLE_TIME, 0.0] <p>The uppercase values are macros defined in <code>simstruc_types.h</code>.</p> <p>If the S-function operates at one rate, this method can alternatively set the sample time to one of the following sample/offset time pairs.</p>

- [INHERITED_SAMPLE_TIME, 0.0]
- [INHERITED_SAMPLE_TIME, FIXED_IN_MINOR_STEP_OFFSET]

If the number of sample times is 0, the Simulink engine assumes that the S-function inherits its sample time from the block to which it is connected, i.e., that the sample time is

```
[ INHERITED_SAMPLE_TIME, 0.0 ]
```

This method can therefore return without doing anything.

Use the following guidelines when specifying sample times.

- A continuous function that changes during minor integration steps should set the sample time to

```
[ CONTINUOUS_SAMPLE_TIME, 0.0 ]
```

- A continuous function that does not change during minor integration steps should set the sample time to

```
[ CONTINUOUS_SAMPLE_TIME, FIXED_IN_MINOR_STEP_OFFSET ]
```

- A discrete function that changes at a specified rate should set the sample time to

```
[ discrete_sample_period, offset ]
```

where

```
discrete_sample_period > 0.0
```

and

```
0.0 <= offset < discrete_sample_period
```

- A discrete function that changes at a variable rate should set the sample time to

mdlInitializeSampleTimes

```
[VARIABLE_SAMPLE_TIME, 0.0]
```

The Simulink engine invokes the `mdlGetTimeOfNextVarHit` function to get the time of the next sample hit for the variable-step discrete task.

Note that `VARIABLE_SAMPLE_TIME` requires a variable-step solver.

- To operate correctly in a triggered subsystem or a periodic system, a discrete S-function should

- Specify a single sample time set to

```
[INHERITED_SAMPLE_TIME, 0.0]
```

- Use `ssSetOptions` to set the `SS_OPTION_DISALLOW_CONSTANT_SAMPLE_TIME` simulation option in `mdlInitializeSizes`

- Verify that it was assigned a discrete or triggered sample time in `mdlSetWorkWidths`:

```
if (ssGetSampleTime(S, 0) == CONTINUOUS_SAMPLE_TIME) {  
    ssSetErrorStatus(S,  
        "This block cannot be assigned a continuous sample  
        time");  
}
```

After propagating sample times throughout the block diagram, the engine assigns the sample time

```
[INHERITED_SAMPLE_TIME, INHERITED_SAMPLE_TIME]
```

to discrete blocks residing in triggered subsystems.

If this function has no intrinsic sample time, it should set its sample time to inherited according to the following guidelines:

- A function that changes as its input changes, even during minor integration steps, should set its sample time to

```
[ INHERITED_SAMPLE_TIME, 0.0]
```

A function that changes as its input changes, but doesn't change during minor integration steps (i.e., is held during minor steps) should set its sample time to

```
[ INHERITED_SAMPLE_TIME, FIXED_IN_MINOR_STEP_OFFSET]
```

The S-function should use the `ssIsSampleHit` or `ssIsContinuousTask` macros to check for a sample hit during execution (in `mdlOutputs` or `mdlUpdate`). For example, if the block's first sample time is continuous, the function can use the following code fragment to check for a sample hit.

```
if (ssIsContinuousTask(S,tid)) {  
}
```

Note The function receives incorrect results if it uses `ssIsSampleHit(S,0,tid)`.

If the function wants to determine whether the third (discrete) task has a hit, it can use the following code fragment.

```
if (ssIsSampleHit(S,2,tid) {  
}
```

mdlInitializeSampleTimes

Note If you have Simulink Coder, when generating code for a noninlined S-function that contains this method, make sure the method is not wrapped in a `#if defined(MATLAB_MEX_FILE)` statement. For example:

```
#if defined(MATLAB_MEX_FILE)
static void mdlInitializeSampleTimes(SimStruct *S)
{
    /* Add mdlInitializeSampleTimes code here */
}
#endif
```

The `define` statement makes the `mdlInitializeSampleTimes` method available only to a MATLAB MEX file. If the S-function is not inlined, the Simulink Coder product cannot use this method, resulting in link or run-time errors.

See Also

`mdlSetInputPortSampleTime`, `mdlSetOutputPortSampleTime`

Purpose	Specify the number of inputs, outputs, states, parameters, and other characteristics of the C MEX S-function
Required	Yes
Languages	C, C++
Syntax	<pre>#define MDL_INITIAL_SIZES void mdlInitializeSizes(SimStruct *S)</pre>
Arguments	S SimStruct representing an S-Function block.
Description	<p>This is the first S-function callback methods that the Simulink engine calls. This method performs the following tasks:</p> <ul style="list-style-type: none">• Specify the number of parameters that this S-function supports, using <code>ssSetNumSFcnParams</code>. Use <code>ssSetSFcnParamTunable(S,paramIdx, 0)</code> when a parameter cannot change during simulation, where <code>paramIdx</code> starts at 0. When a parameter has been specified as not tunable, the engine issues an error during simulation (or when in external mode when using the Simulink Coder product) if an attempt is made to change the parameter.• Specify the number of states that this function has, using <code>ssSetNumContStates</code> and <code>ssSetNumDiscStates</code>.• Configure the block's input ports, including:<ul style="list-style-type: none">▪ Specify the number of input ports that this S-function has, using <code>ssSetNumInputPorts</code>.▪ Specify the dimensions of the input ports. See <code>ssSetInputPortDimensionInfo</code> for more information.

- For each input port, specify whether it has direct feedthrough, using `ssSetInputPortDirectFeedThrough`.

A port has direct feedthrough if the input is used in either the `mdlOutputs` or `mdlGetTimeOfNextVarHit` function. The direct feedthrough flag for each input port can be set to either 1=yes or 0=no. It should be set to 1 if the input, `u`, is used in the `mdlOutputs` or `mdlGetTimeOfNextVarHit` routine. Setting the direct feedthrough flag to 0 tells the Simulink engine that `u` is not used in either of these S-function routines. Violating this leads to unpredictable results.

- Configure the block's output ports, including:
 - Specify the number of output ports that the block has, using `ssSetNumOutputPorts`.
 - Specify the dimensions of the output ports.

See `mdlSetOutputPortDimensionInfo` for more information.

If your S-function outputs are discrete (for example, the outputs only take specific values such as 0, 1, and 2), specify `SS_OPTION_DISCRETE_VALUED_OUTPUT`.

- Set the number of sample times (i.e., sample rates) at which the block operates.

There are two ways of specifying sample times:

- Port-based sample times
- Block-based sample times

See “Sample Times” on page 8-32 for a complete discussion of sample time issues.

For multirate S-functions, the suggested approach to setting sample times is via the port-based sample times method. When you create a multirate S-function, you must take care to verify that, when slower tasks are preempted, your S-function correctly manages data so as to avoid race conditions. When port-based sample times are specified, the block cannot inherit a constant sample time at any port.

- Set the size of the block's work vectors, using `ssSetNumRWork`, `ssSetNumIWork`, `ssSetNumPWork`, `ssSetNumModes`, `ssSetNumNonsampledZCs`.
- Set the simulation options that this block implements, using `ssSetOptions`.

All options have the form `SS_OPTION_<name>`. See “Information and Options” for information on each option. Use a bitwise OR operator to set multiple options, as in

```
ssSetOptions(S, (SS_OPTION_name1 | SS_OPTION_name2))
```

Note If you have Simulink Coder, when generating code for a noninlined S-function that contains this method, make sure the method is not wrapped in a `#if defined(MATLAB_MEX_FILE)` statement. For example:

```
#if defined(MATLAB_MEX_FILE)
static void mdlInitializeSizes(SimStruct *S)
{
    /* Add mdlInitializeSizes code here */
}
#endif
```

The `define` statement makes the `mdlInitializeSizes` method available only to a MATLAB MEX file. If the S-function is not inlined, the Simulink Coder product cannot use this method, resulting in link or run-time errors.

Dynamically Sized Block Features

You can set the parameters `NumContStates`, `NumDiscStates`, `NumInputs`, `NumOutputs`, `NumRWork`, `NumIWork`, `NumPWork`, `NumModes`, and `NumNonsampledZCs` to a fixed nonnegative integer or tell the Simulink engine to size them dynamically:

mdlInitializeSizes

- `DYNAMICALLY_SIZED` -- Sets lengths of states, work vectors, and so on to values inherited from the driving block. It sets widths to the actual input widths, according to the scalar expansion rules unless you use `mdlSetWorkWidths` to set the widths.
- 0 or positive number -- Sets lengths (or widths) to the specified values. The default is 0.

Initialization for MATLAB S-Functions

The Level-2 MATLAB S-function `setup` method performs nearly the same tasks as the C MEX S-function `mdlInitializeSizes` method.

Example

```
static void mdlInitializeSizes(SimStruct *S)
{
    int_T nInputPorts = 1; /* number of input ports */
    int_T nOutputPorts = 1; /* number of output ports */
    int_T needsInput = 1; /* direct feedthrough */

    int_T inputPortIdx = 0;
    int_T outputPortIdx = 0;

    ssSetNumSFcnParams(S, 0); /* Number of expected parameters */
    if (ssGetNumSFcnParams(S) != ssGetSFcnParamsCount(S)) {
        /*
         * If the number of expected input parameters is not
         * equal to the number of parameters entered in the
         * dialog box, return. The Simulink engine generates an
         * error indicating that there is a parameter mismatch.
         */
        return;
    } else {
        mdlCheckParameters(S);

        if (ssGetErrorStatus(s) != NULL)
            return;
    }
}
```

```
ssSetNumContStates( S, 0);
ssSetNumDiscStates( S, 0);

/*
 * Configure the input ports. First set the number of input
 * ports.
 */
if (!ssSetNumInputPorts(S, nInputPorts)) return;
/*
 * Set input port dimensions for each input port index
 * starting at 0.

*/
if(!ssSetInputPortDimensionInfo(S, inputPortIdx,
    DYNAMIC_DIMENSION)) return;
/*
 * Set direct feedthrough flag (1=yes, 0=no).
 */
ssSetInputPortDirectFeedThrough(S, inputPortIdx, needsInput);

/*
 * Configure the output ports. First set the number of
 * output ports.
 */
if (!ssSetNumOutputPorts(S, nOutputPorts)) return;

/*
 * Set output port dimensions for each output port index
 * starting at 0.
 */
if(!ssSetOutputPortDimensionInfo(S,outputPortIdx,
    DYNAMIC_DIMENSION)) return;

/*
 * Set the number of sample times. */
```

mdlInitializeSizes

```
ssSetNumSampleTimes(S, 1);

/*
 * Set size of the work vectors.
 */
ssSetNumRWork(S, 0); /* real vector */
ssSetNumIWork(S, 0); /* integer vector */
ssSetNumPWork(S, 0); /* pointer vector */
ssSetNumModes(S, 0); /* mode vector */
ssSetNumNonsampledZCs(S, 0); /* zero crossings */

ssSetOptions(S, 0);

} /* end mdlInitializeSizes */
```

See Also

setup, mdlInitializeSampleTimes

Purpose	Compute the signals that this block emits
Required	Yes
Languages	C, C++
Syntax	<pre>#define MDL_OUTPUTS void mdlOutputs(SimStruct *S, int_T tid)</pre>
Arguments	<p>S SimStruct representing an S-Function block.</p> <p>tid Task ID.</p>
Description	<p>The Simulink engine invokes this required method at each simulation time step. The method should compute the S-function's outputs at the current time step and store the results in the S-function's output signal arrays.</p> <p>The tid (task ID) argument specifies the task running when the mdlOutputs routine is invoked. You can use this argument in the mdlOutputs routine of a multirate S-Function block to encapsulate task-specific blocks of code (see "Multirate S-Function Blocks" on page 8-44).</p> <p>Use the UNUSED_ARG macro if the S-function does not contain task-specific blocks of code to indicate that the tid input argument is required but not used in the body of the callback. To do this, insert the line</p> <pre>UNUSED_ARG(tid)</pre> <p>after the declarations in mdlOutputs.</p>

Note If you have Simulink Coder, when generating code for a noninlined S-function that contains this method, make sure the method is not wrapped in a `#if defined(MATLAB_MEX_FILE)` statement. For example:

```
#if defined(MATLAB_MEX_FILE)
static void mdlOutputs(SimStruct *S)
{
    /* Add mdlOutputs code here */
}
#endif
```

The `define` statement makes the `mdlOutputs` method available only to a MATLAB MEX file. If the S-function is not inlined, the Simulink Coder product cannot use this method, resulting in link or run-time errors.

Example

For an example of an `mdlOutputs` routine that works with multiple input and output ports, see `sfun_multiport.c`.

See Also

`ssGetOutputPortComplexSignal`, `ssGetOutputPortRealSignal`, `ssGetOutputPortSignal`, `Outputs`

Purpose Process the C MEX S-function's parameters

Required No

Languages C, C++

Syntax

```
#define MDL_PROCESS_PARAMETERS
void mdlProcessParameters(SimStruct *S)
```

Arguments

S
SimStruct representing an S-Function block.

Description

This is an optional routine that the Simulink engine calls after `mdlCheckParameters` changes and verifies parameters. The processing is done at the top of the simulation loop when it is safe to process the changed parameters. This function is only valid for simulation. C MEX S-functions must enclose the method in a `#if defined(MATLAB_MEX_FILE)` statement.

The purpose of this routine is to process newly changed parameters. An example is to cache parameter changes in work vectors. The engine does not call this routine when it is used with the Simulink Coder product. Therefore, if you use this routine in an S-function designed for use with the Simulink Coder product, you must write your S-function so that it doesn't rely on this routine. To do this, you must inline your S-function by using the Target Language Compiler. For information on inlining S-functions, see "Inlining S-Functions".

Example

This example processes a string parameter that `mdlCheckParameters` has verified to be of the form '+++' (where there could be any number of '+' or '-' characters).

```
#define MDL_PROCESS_PARAMETERS /* Change to #undef to remove function */
#if defined(MDL_PROCESS_PARAMETERS) && defined(MATLAB_MEX_FILE)
static void mdlProcessParameters(SimStruct *S)
```

mdlProcessParameters

```
{
    int_T i;
    char_T *plusMinusStr;
    int_T nInputPorts = ssGetNumInputPorts(S);
    int_T *iwork      = ssGetIWork(S);
    if ((plusMinusStr=(char_T*)malloc(nInputPorts+1)) == NULL) {
        ssSetErrorStatus(S,"Memory allocation error in mdlStart");
        return;
    }
    if (mxGetString(SIGNS_PARAM(S),plusMinusStr,nInputPorts+1) != 0) {
        free(plusMinusStr);
        ssSetErrorStatus(S,"mxGetString error in mdlStart");
        return;
    }
    for (i = 0; i < nInputPorts; i++) {
        iwork[i] = plusMinusStr[i] == '+'? 1: -1;
    }
    free(plusMinusStr);
}
#endif /* MDL_PROCESS_PARAMETERS */
```

mdlProcessParameters is called from mdlStart to load the signs string prior to the start of the simulation loop.

```
#define MDL_START
#if defined(MDL_START)
static void mdlStart(SimStruct *S)
{
    mdlProcessParameters(S);
}
#endif /* MDL_START */
```

See Also

mdlCheckParameters, ProcessParameters

Purpose	Perturb the solver's solution of a system's states to better satisfy time-invariant solution relationships
Required	No
Languages	C, C++
Syntax	<pre>#define MDL_PROJECTION void mdlProjection(SimStruct *S)</pre>
Arguments	S SimStruct representing an S-Function block.
Description	<p>This method is intended for use with S-functions that model dynamic systems whose states satisfy time-invariant relationships, such as those resulting from mass or energy conservation or other physical laws. The Simulink engine invokes this method at each time step after the model's solver has computed the S-function's states for that time step. Typically, slight errors in the numerical solution of the states cause the solutions to fail to satisfy solution invariants exactly. Your <code>mdlProjection</code> method can compensate for the errors by perturbing the states so that they more closely approximate solution invariants at the current time step. As a result, the numerical solution adheres more closely to the ideal solution as the simulation progresses, producing a more accurate overall simulation of the system modeled by your S-function.</p> <p>Your <code>mdlProjection</code> method's perturbations of system states must fall within the solution error tolerances specified by the model in which the S-function is embedded. Otherwise, the perturbations may invalidate the solver's solution. It is up to your <code>mdlProjection</code> method to ensure that the perturbations meet the error tolerances specified by the model. See "Perturbing a System's States Using a Solution Invariant" on page 9-42 for a simple method for perturbing a system's states. The following articles describe more sophisticated perturbation methods that your <code>mdlProjection</code> method can use.</p>

- C.W. Gear, “Maintaining Solution Invariants in the Numerical Solution of ODEs,” *Journal on Scientific and Statistical Computing*, Vol. 7, No. 3, July 1986.
- L.F. Shampine, “Conservation Laws and the Numerical Solution of ODEs I,” *Computers and Mathematics with Applications*, Vol. 12B, 1986, pp. 1287–1296.
- L.F. Shampine, “Conservation Laws and the Numerical Solution of ODEs II,” *Computers and Mathematics with Applications*, Vol. 38, 1999, pp. 61–72.

Example

Perturbing a System’s States Using a Solution Invariant

Here is a simple, Taylor-series-based approach to perturbing a system’s states. Suppose your S-function models a dynamic system having a solution invariant, $g(X, t)$, i.e., g is a continuous, differentiable function of the system states, X , and time, t , whose value is constant with time. Then

$$X_n \cong X_n^* + J_n^T (J_n J_n^T)^{-1} R_n$$

where

- X_n is the system’s ideal state vector at the solver’s current time step
- X_n^* is the approximate state vector computed by the solver at the current time step
- J_n is the Jacobian of the invariant function evaluated at the point in state space specified by the approximate state vector at the current time step:

$$J_n = \frac{\partial g}{\partial X}(X_n^*, t_n)$$

- t_n is the time at the current time step

- R_n is the residual (difference) between the invariant function evaluated at X_n and X_n^* at the current time step:

$$R_n = g(X_n, t_n) - g(X_n^*, t_n)$$

Note The value of $g(X_n, t_n)$ is the same at each time step and is known by definition.

Given a continuous, differentiable invariant function for the system that your S-function models, this formula allows your S-function's mdlProjection method to compute a perturbation

$$J_n^T (J_n J_n^T)^{-1} R_n$$

of the solver's numerical solution, X_n^* , that more closely matches the ideal solution, X_n , keeping the S-function's solution from drifting from the ideal solution as the simulation progresses.

MATLAB Example

This example illustrates how the perturbation method outlined in the previous section can keep a model's numerical solution from drifting from the ideal solution as a simulation progresses. Consider the following model, mdlProjectionEx1:

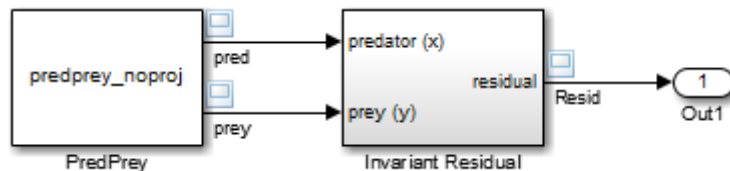

The PredPrey block references an S-function, predprey_noproj.m, that uses the Lotka-Volterra equations

$$\begin{aligned}\dot{x} &= ax(1-y) \\ \dot{y} &= -cy(1-x)\end{aligned}$$

to model predator-prey population dynamics, where $x(t)$ is the population density of the predators and $y(t)$ is the population density of prey. The ideal solution to the predator-prey ODEs satisfies the time-invariant function

$$x^{-c} e^{cx} y^{-a} e^{ay} = d$$

where a , c , and d are constants. The S-function assumes $a = 1$, $c = 2$, and $d = 121.85$.

The Invariant Residual block in this model computes the residual between the invariant function evaluated along the system's ideal trajectory through state space and its simulated trajectory:

$$R_n = d - x_n^{-c} e^{cx_n} y_n^{-a} e^{ay_n}$$

where x_n and y_n are the values computed by the model's solver for the predator and prey population densities, respectively, at the current time step. Ideally, the residual should be zero throughout simulation of the model, but simulating the model reveals that the residual actually strays considerably from zero:

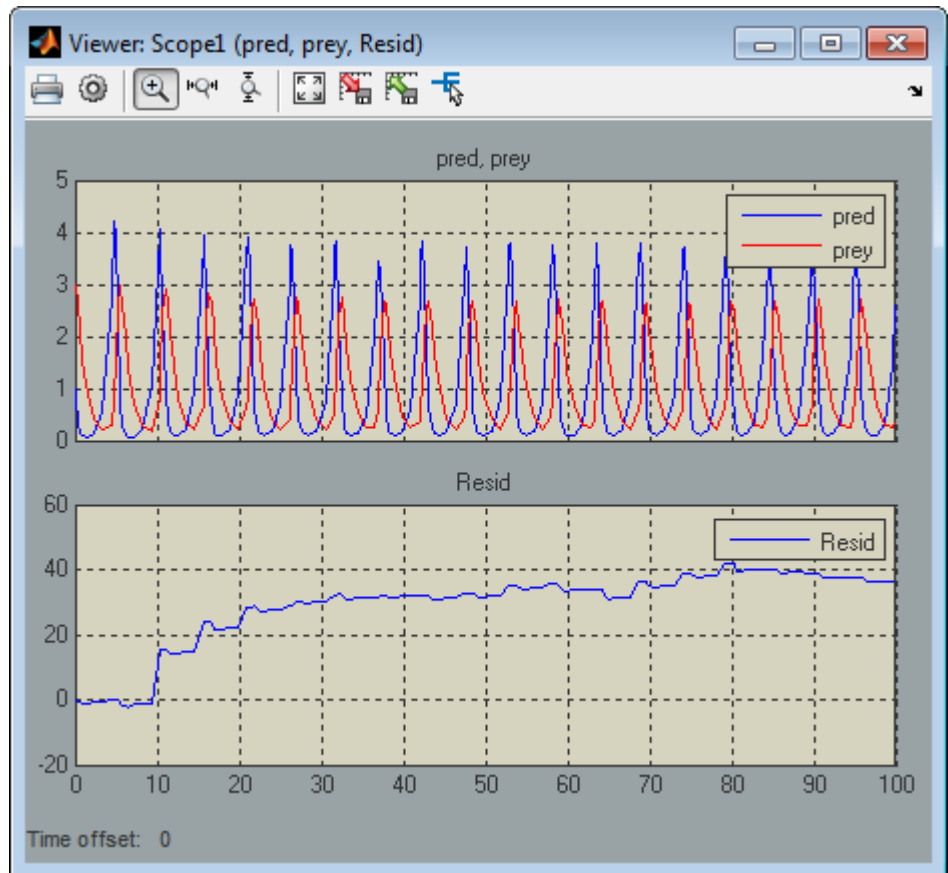

Now consider the following model, mdlProjectionEx2:

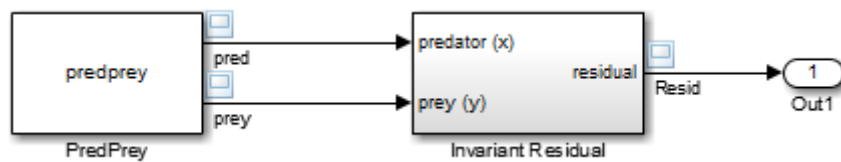

mdlProjection

This model is the same as the previous model, except that its S-function, `predprey.m`, includes a `mdlProjection` method that uses the perturbation approach outlined in “Perturbing a System’s States Using a Solution Invariant” on page 9-42 to compensate for numerical drift. As a result, the numerical solution more closely tracks the ideal solution as the simulation progresses as demonstrated by the residual signal, which remains near or at zero throughout the simulation:

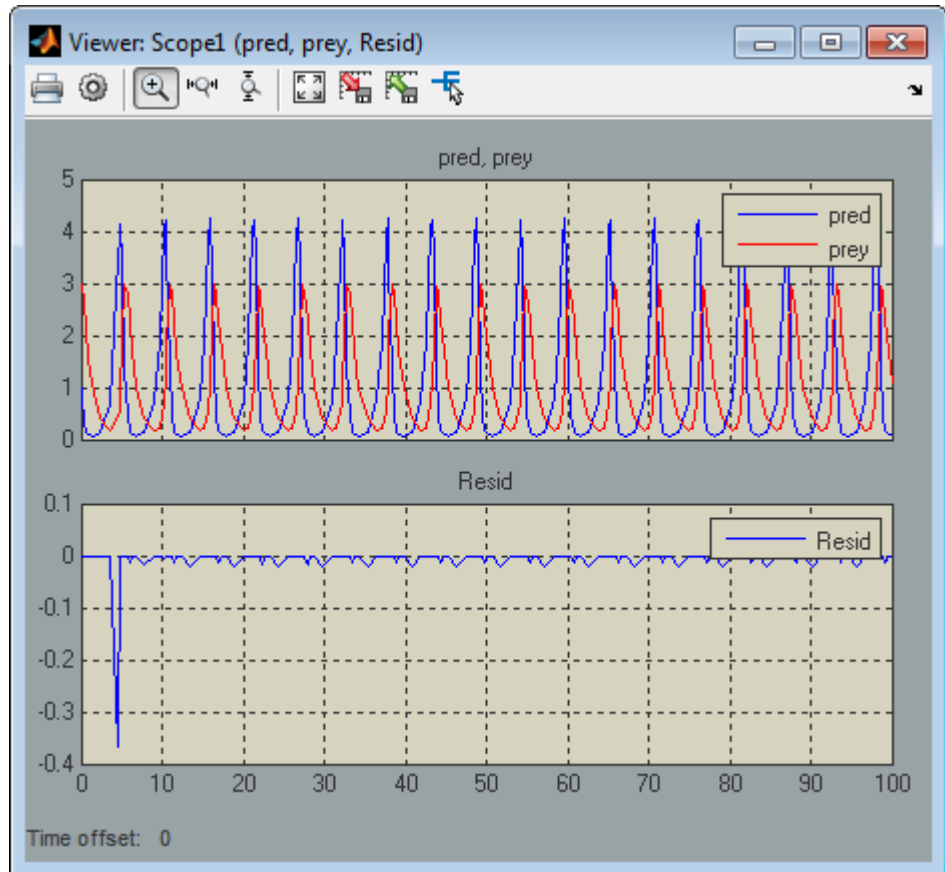

See Also Projection

Purpose Generate code generation data for a C MEX S-function

Required No

Languages C, C++

Syntax

```
#define MDL_RTW
void mdlRTW(SimStruct *S)
```

Arguments S
SimStruct representing an S-Function block.

Description This function is called when the Simulink Coder product is generating the *model.rtw* file. In C MEX S-functions, you can call the following functions that add fields to the *model.rtw* file:

- `ssWriteRTWParameters`
- `ssWriteRTWParamSettings`
- `ssWriteRTWWorkVect`
- `ssWriteRTWStr`
- `ssWriteRTWStrParam`
- `ssWriteRTWScalarParam`
- `ssWriteRTWStrVectParam`
- `ssWriteRTWVectParam`
- `ssWriteRTW2dMatParam`
- `ssWriteRTWMxVectParam`
- `ssWriteRTWMx2dMatParam`

In C MEX S-functions, this function must be enclosed in a `#if defined(MATLAB_MEX_FILE)` statement.

Example

See the S-function `sfun_multiport.c` in the Simulink model `sldemo_msfcn_lms` for an example.

See Also

`ssSetInputPortFrameData`, `ssSetOutputPortFrameData`,
`ssSetErrorStatus`, `WriteRTW`

mdlSetDefaultPortComplexSignals

Purpose	Set the numeric types (real, complex, or inherited) of ports whose numeric types cannot be determined from block connectivity
Required	No
Languages	C, C++
Syntax	<pre>#define MDL_SET_DEFAULT_PORT_COMPLEX_SIGNALS void mdlSetDefaultPortComplexSignals(SimStruct *S)</pre>
Arguments	S SimStruct representing an S-Function block.
Description	<p>The Simulink engine invokes this method if the block has ports whose numeric types cannot be determined from connectivity. (This usually happens when the block is unconnected or is part of a feedback loop.) This method must set the numeric types of all ports whose numeric types are not set. This method is only valid for simulation, and must be enclosed in a <code>#if defined(MATLAB_MEX_FILE)</code> statement.</p> <p>If the block does not implement this method and at least one port is known to be complex, the engine sets the unknown ports to <code>COMPLEX_YES</code>; otherwise, it sets the unknown ports to <code>COMPLEX_NO</code>.</p>
See Also	<code>ssSetOutputPortComplexSignal</code> , <code>ssSetInputPortComplexSignal</code>

Purpose	Set the data types of ports whose data types cannot be determined from block connectivity
Required	No
Languages	C, C++
Syntax	<pre>#define MDL_SET_DEFAULT_PORT_DATA_TYPES void mdlSetDefaultPortDataTypes(SimStruct *S)</pre>
Arguments	S SimStruct representing an S-Function block.
Description	<p>The Simulink engine invokes this method if the block has ports whose data types cannot be determined from block connectivity. (This usually happens when the block is unconnected or is part of a feedback loop.) This method must set the data types of all ports whose data types are not set. This method is only valid for simulation, and must be enclosed in a <code>#if defined(MATLAB_MEX_FILE)</code> statement.</p> <p>If the block does not implement this method and the engine cannot determine the data types of any of its ports, the engine sets the data types of all the ports to <code>double</code>. If the block does not implement this method and the engine cannot determine the data types of some, but not all, of its ports, the engine sets the unknown ports to the data type of the port whose data type has the largest size.</p> <p>The engine invokes an error if the <code>mdlSetDefaultPortDataType</code> method attempts to modify the data type of a port when the data type was previously specified by <code>mdlSetInputPortDataType</code> or <code>mdlSetOutputPortDataType</code>. If an S-function has multiple input or output ports, <code>mdlSetDefaultPortDataType</code> should check if the data type of a port is still dynamic before attempting to set the type. For example, the <code>mdlSetDefaultPortDataType</code> uses the following lines to check if the data type of the second input port is still unknown.</p>

mdlSetDefaultPortDataTypes

```
if (ssGetInputPortDataType(S, 1) == DYNAMICALLY_TYPED) {  
    ssSetInputPortDataType(S, 1, SS_UINT8 );  
}
```

See Also

ssSetOutputPortDataType, ssSetInputPortDataType

Purpose	Set the default dimensions of the signals accepted or emitted by a C MEX S-function's ports
Required	No
Languages	C, C++
Syntax	<pre>#define MDL_SET_DEFAULT_PORT_DIMENSION_INFO void mdlSetDefaultPortDimensionInfo(SimStruct *S)</pre>
Arguments	S SimStruct representing an S-Function block.
Description	<p>The Simulink engine calls this method during signal dimension propagation when a model does not supply enough information to determine the dimensionality of signals that can enter or leave the block represented by S. This method should set the dimensions of any input and output ports that are dynamically sized to default values. This method is only valid for simulation, and must be enclosed in a <code>#if defined(MATLAB_MEX_FILE)</code> statement.</p> <p>If the S-function does not implement this method, the engine tries to find a set of dimensions that will satisfy the dimension propagation rules implemented using <code>mdlSetInputPortDimensionInfo</code> and <code>mdlSetOutputPortDimensionInfo</code>. This process might not be able to produce a valid set of dimensions for S-functions with special dimension requirements.</p> <p>The engine invokes an error if the <code>mdlSetDefaultPortDimensionInfo</code> method attempts to modify the dimensions of a port when the dimensions were previously specified by <code>mdlSetInputPortDimensionInfo</code> or <code>mdlSetOutputPortDimensionInfo</code>. If an S-function has multiple input or output ports, <code>mdlSetDefaultPortDimensionInfo</code> should check if the dimensions of the port are still dynamic before attempting to set the dimensions. For example, the <code>mdlSetDefaultPortDimensionInfo</code></p>

mdlSetDefaultPortDimensionInfo

uses the following lines to check if the dimensions of the first output port are still unknown.

```
if (ssGetOutputPortWidth(S, 0) == DYNAMICALLY_SIZED) {  
    ssSetOutputPortMatrixDimensions(S, 0, 1, 1 );  
}
```

Example

See `sfun_matadd.c` for an example of how to use this function.

See Also

`ssSetErrorStatus`, `ssSetOutputPortMatrixDimensions`

Purpose	Set the numeric types (real, complex, or inherited) of the signals accepted by an input port
Required	No
Languages	C, C++
Syntax	<pre>#define MDL_SET_INPUT_PORT_COMPLEX_SIGNAL void mdlSetInputPortComplexSignal(SimStruct *S, int_T port, CSignal_T csig)</pre>
Arguments	<p>S SimStruct representing an S-Function block.</p> <p>port Index of a port.</p> <p>csig Numeric type of signal, either <code>COMPLEX_NO</code> (real) or <code>COMPLEX_YES</code> (complex).</p>
Description	<p>The Simulink engine calls this routine to set the input port numeric type for inputs that have this attribute set to <code>COMPLEX_INHERITED</code>. The input <code>csig</code> is the proposed numeric type for this input port. This method is only valid for simulation. C MEX S-functions must enclosed this method in a <code>#if defined(MATLAB_MEX_FILE)</code> statement.</p> <p>The S-function must check whether the proposed numeric type is a valid type for the specified port. If it is valid, a C MEX S-function sets the numeric type of the specified input port using <code>ssSetInputPortComplexSignal</code>. Otherwise, it reports an error using <code>ssSetErrorStatus</code>.</p> <p>The S-function can also set the numeric types of other input and output ports with inherited numeric types. The engine reports an error if the S-function changes the numeric type of a port whose numeric type is known.</p>

mdlSetInputPortComplexSignal

If the S-function does not implement this routine, the engine assumes that the S-function accepts a real or complex signal and sets the input port numeric type to the specified value.

The engine calls this method until all input ports with inherited numeric types have their numeric types specified.

Example

See `sdotproduct.c` for an example of how to use this function.

See Also

`ssSetErrorStatus`, `ssSetInputPortComplexSignal`,
`SetInputPortComplexSignal`

Purpose	Set the data types of the signals accepted by an input port
Required	No
Languages	C, C++
Syntax	<pre>#define MDL_SET_INPUT_PORT_DATA_TYPE void mdlSetInputPortDataType(SimStruct *S, int_T port, DTypeId id)</pre>
Arguments	<p>S SimStruct representing an S-Function block.</p> <p>port Index of a port.</p> <p>id Data type ID.</p>
Description	<p>The Simulink engine calls this routine to set the data type of port when port has an inherited data type. The data type id is the proposed data type for this port. Data type IDs for the built-in data types can be found in <code>simstruc_types.h</code>. This method is only valid for simulation. C MEX S-functions must enclose this method in a <code>#if defined(MATLAB_MEX_FILE)</code> statement.</p> <p>The S-function must check whether the specified data type is a valid data type for the specified port. If it is a valid data type, a C MEX S-functions sets the data type of the input port using <code>ssSetInputPortDataType</code>. Otherwise, it reports an error using <code>ssSetErrorStatus</code>.</p> <p>The S-function can also set the data types of other input and output ports if they are unknown. The engine reports an error if the S-function changes the data type of a port whose data type has been set.</p>

mdlSetInputPortDataType

If the block does not implement this routine, the engine assumes that the block accepts any data type and sets the input port data type to the specified value.

The engine calls this method until all input ports with inherited data types have their data types specified.

See Also

ssSetErrorStatus, ssSetInputPortDataType, SetInputPortDataType

Purpose	Set the dimensions of the signals accepted by an input port
Required	No
Languages	C, C++
Syntax	<pre>#define MDL_SET_INPUT_PORT_DIMENSION_INFO void mdlSetInputPortDimensionInfo(SimStruct *S, int_T port, const DimsInfo_T *dimsInfo)</pre>
Arguments	<p>S SimStruct representing an S-Function block.</p> <p>port Index of a port.</p> <p>dimsInfo Structure that specifies the signal dimensions supported by the port.</p> <p>See <code>ssSetInputPortDimensionInfo</code> for a description of this structure.</p>
Description	<p>The Simulink engine calls this method during dimension propagation with candidate dimensions <code>dimsInfo</code> for <code>port</code>. In C MEX S-functions, if the proposed dimensions are acceptable, the method sets the actual port dimensions, using <code>ssSetInputPortDimensionInfo</code>. If they are unacceptable, the method generates an error via <code>ssSetErrorStatus</code>.</p> <p>This method is only valid for simulation. A C MEX S-function must enclose the method in a <code>#if defined(MATLAB_MEX_FILE)</code> statement.</p>

Note This method can set the dimensions of any other input or output port whose dimensions derive from the dimensions of `port`.

mdlSetInputPortDimensionInfo

By default, the engine calls this method only if it can fully determine the dimensionality of port from the port to which it is connected. For C MEX S-functions, if the engine cannot completely determine the dimensionality from port connectivity, it invokes `mdlSetDefaultPortDimensionInfo`. If an S-function can fully determine the port dimensionality from partial information, set the option `SS_OPTION_ALLOW_PARTIAL_DIMENSIONS_CALL` in `mdlInitializeSizes`, using `ssSetOptions`. If this option is set, the engine invokes `mdlSetInputPortDimensionInfo` even if it can only partially determine the dimensionality of the input port from connectivity.

The engine calls this method until all input ports with inherited dimensions have their dimensions specified.

Example

See `sfun_matadd.c` for an example of how to use this function.

See Also

`ssSetErrorStatus`, `mdlSetOutputPortDimensionInfo`,
`SetInputPortDimensions`

mdlSetInputPortDimensionsModeFcn

Purpose	Propagate the dimensions mode
Required	No
Languages	C, C++
Syntax	<pre>void mdlSetInputPortDimensionsModeFcn(SimStruct *S, int_T portIdx, DimensionsMode_T dimsMode)</pre>
Arguments	<p>S SimStruct representing an S-Function block.</p> <p>portIdx Index of a port.</p> <p>dimsMode Current dimensions mode. Possible values are INHERIT_DIMS_MODE, FIXED_DIMS_MODE, and VARIABLE_DIMS_MODE</p>
Description	The Simulink engine calls this optional method to enable this S-function to set the dimensions mode of the input port indexed by portIdx.
C Example	See <code>sfun_varsize_holdStatesUntilReset.c</code> for an example of how to use this function.
See Also	<code>mdlSetInputPortDimensionInfo</code> , <code>SetInputPortDimensionsMode</code>

mdlSetInputPortFrameData

Purpose	Specify whether an input port accepts frame data
Required	No
Languages	C, C++
Syntax	<pre>#define MDL_SET_INPUT_PORT_FRAME_DATA void mdlSetInputPortFrameData(SimStruct *S, int_T port, Frame_T frameData)</pre>
Arguments	<p>S SimStruct representing an S-Function block.</p> <p>port Index of a port.</p> <p>frameData String indicating if the input port accepts frame data.</p>
Description	<p>This method is called with the candidate frame setting for an input port.</p> <p>For C MEX S-functions, <code>frameData</code> is either <code>FRAME_YES</code> or <code>FRAME_NO</code>. If the proposed setting is acceptable, the method sets the actual frame data setting using <code>ssSetInputPortFrameData</code>. If the setting is unacceptable, the method generates an error via <code>ssSetErrorStatus</code>. Note that any other input or output ports whose frame data settings are implicitly defined by virtue of knowing the frame data setting of the given port can also have their frame data settings configured. This method is only valid for simulation, and must be enclosed in a <code>#if defined(MATLAB_MEX_FILE)</code> statement.</p> <p>The Simulink engine calls this method until all input ports with inherited frame settings have their frame settings specified.</p> <p>The use of frame-based signals (<code>mode</code> has a value of 1 or <code>frameData</code> has a value of <code>FRAME_YES</code>) requires a DSP System Toolbox license.</p>

See Also

ssSetInputPortFrameData, ssSetOutputPortFrameData,
ssSetErrorStatus, SetInputPortSamplingMode

mdlSetInputPortSampleTime

Purpose Set the sample time of an input port that inherits its sample time from the port to which it is connected

Required No

Languages C, C++

Syntax

```
#define MDL_SET_INPUT_PORT_SAMPLE_TIME
void mdlSetInputPortSampleTime(SimStruct *S, int_T port,
    real_T sampleTime, real_T offsetTime)
```

Arguments

S
SimStruct representing an S-Function block.

port
Index of a port.

sampleTime
Inherited sample time for port.

offsetTime
Inherited offset time for port.

Description The Simulink engine invokes this method with the sample time that port inherits from the port to which it is connected.

For C MEX S-functions, if the inherited sample time is acceptable, this method sets the sample time of port to the inherited time, using `ssSetInputPortSampleTime` and `ssSetInputPortOffsetTime`. If the sample time is unacceptable, this method generates an error via `ssSetErrorStatus`. Note that any other input or output ports whose sample times are implicitly defined by virtue of knowing the sample time of the given port can also have their sample times set via calls to `ssSetInputPortSampleTime` or `ssSetOutputPortSampleTime`. This method is only valid for simulation, and must be enclosed in a `#if defined(MATLAB_MEX_FILE)` statement.

The engine calls this method until all input ports with inherited sample times are specified.

When inherited port-based sample times are specified, the sample time is guaranteed to be one of the following where $0.0 < \text{period} < \text{inf}$ and $0.0 \leq \text{offset} < \text{period}$.

	Sample Time	Offset Time
Continuous	0.0	0.0
Discrete	period	offset

Constant, triggered, and variable-step sample times are not propagated to S-functions with port-based sample times.

Generally `mdlSetInputPortSampleTime` is called once per port with the input port sample time. However, there can be cases where this function is called more than once. This happens when the simulation engine is converting continuous sample times to continuous but fixed in minor steps sample times. When this occurs, the original values of the sample times specified in `mdlInitializeSizes` are restored before this method is called again.

The final sample time specified at the port can be different from (but equivalent to) the sample time specified by this method. This occurs when

- The model uses a fixed-step solver and the port has a continuous but fixed in minor step sample time. In this case, the Simulink engine converts the sample time to the fundamental sample time for the model.
- The engine adjusts the sample time to be as numerically sound as possible. For example, the engine converts `[0.249999999999, 0]` to `[0.25, 0]`.

The S-function can examine the final sample times in `mdlInitializeSampleTimes`.

mdlSetInputPortSampleTime

See Also

ssSetInputPortSampleTime, ssSetOutputPortSampleTime,
mdlInitializeSampleTimes, SetInputPortSampleTime

Purpose	Set the width of an input port that accepts 1-D (vector) signals
Required	No
Languages	C, C++
Syntax	<pre>#define MDL_SET_INPUT_PORT_WIDTH void mdlSetInputPortWidth(SimStruct *S, int_T port, int_T width)</pre>
Arguments	<p>S SimStruct representing an S-Function block.</p> <p>port Index of a port.</p> <p>width Width of signal.</p>
Description	<p>This method is called with the candidate width for a dynamically sized port. If the proposed width is acceptable, the method should set the actual port width using <code>ssSetInputPortWidth</code>. If the size is unacceptable, an error should be generated via <code>ssSetErrorStatus</code>. Note that any other dynamically sized input or output ports whose widths are implicitly defined by virtue of knowing the width of the given port can also have their widths set via calls to <code>ssSetInputPortWidth</code> or <code>ssSetOutputPortWidth</code>. This method is only valid for simulation, and must be enclosed in a <code>#if defined(MATLAB_MEX_FILE)</code> statement.</p> <p>The Simulink engine invokes this method until all dynamically sized input ports are configured.</p>
See Also	<code>ssSetInputPortWidth</code> , <code>ssSetOutputPortWidth</code> , <code>ssSetErrorStatus</code>

mdlSetOutputPortComplexSignal

Purpose	Set the numeric types (real, complex, or inherited) of the signals accepted by an output port
Required	No
Languages	C, C++
Syntax	<pre>#define MDL_SET_OUTPUT_PORT_COMPLEX_SIGNAL void mdlSetOutputPortComplexSignal(SimStruct *S, int_T port, CSignal_T csig)</pre>
Arguments	<p>S SimStruct representing an S-Function block.</p> <p>port Index of a port.</p> <p>csig Numeric type of signal, either COMPLEX_NO (real) or COMPLEX_YES (complex).</p>
Description	<p>The Simulink engine calls this routine to set the output port numeric type for outputs that have this attribute set to COMPLEX_INHERITED. The input argument <code>csig</code> is the proposed numeric type for this output port. The S-function must check whether the specified numeric type is a valid type for the specified port.</p> <p>If it is valid, C MEX S-functions set the numeric type of the specified output port using <code>ssSetOutputPortComplexSignal</code>. Otherwise, the S-function reports an error, using <code>ssSetErrorStatus</code>. This method is only valid for simulation. C MEX S-functions must enclose the method in a <code>#if defined(MATLAB_MEX_FILE)</code> statement.</p> <p>The S-function can also set the numeric types of other input and output ports with unknown numeric types. The engine reports an error if the S-function changes the numeric type of a port whose numeric type is known.</p>

If the S-function does not implement this routine, the engine assumes that the S-function accepts a real or complex signal and sets the output port numeric type to the specified value.

The engine calls this method until all output ports with inherited numeric types have their numeric types specified.

Example

See `sdotproduct.c` for an example of how to use this function.

See Also

`ssSetOutputPortComplexSignal`, `ssSetErrorStatus`,
`SetOutputPortComplexSignal`

mdlSetOutputPortDataType

Purpose	Set the data type of the signals emitted by an output port
Required	No
Languages	C, C++
Syntax	<pre>#define MDL_SET_OUTPUT_PORT_DATA_TYPE void mdlSetOutputPortDataType(SimStruct *S, int_T port, DTypeId id)</pre>
Arguments	<p>S SimStruct representing an S-Function block.</p> <p>port Index of an output port.</p> <p>id Data type ID.</p>
Description	<p>The Simulink engine calls this routine to set the data type of port when port has an inherited data type. The data type ID id is the proposed data type for this port. Data type IDs for the built-in data types can be found in <code>simstruc_types.h</code>. The S-function must check whether the specified data type is a valid data type for the specified port.</p> <p>If it is a valid data type, a C MEX S-function sets the data type of port using <code>ssSetOutputPortDataType</code>. Otherwise, the S-function reports an error, using <code>ssSetErrorStatus</code>. This method is only valid for simulation. C MEX S-functions must enclose the method in a <code>#if defined(MATLAB_MEX_FILE)</code> statement.</p> <p>The S-function can also set the data types of other input and output ports if their data types have not been set. The engine reports an error if the S-function changes the data type of a port whose data type has been set.</p> <p>If the block does not implement this method, the engine assumes that the block supports any data type and sets the output port data type to the specified value.</p>

The engine calls this method until all output ports with inherited data types have their data types specified.

See Also

ssSetOutputPortDataType, ssSetErrorStatus,
SetOutputPortDataType

mdlSetOutputPortDimensionInfo

Purpose	Set the dimensions of the signals accepted by an output port
Required	No
Languages	C, C++
Syntax	<pre>#define MDL_SET_OUTPUT_PORT_DIMENSION_INFO void mdlSetOutputPortDimensionInfo(SimStruct *S, int_T port, const DimsInfo_T *dimsInfo)</pre>

Arguments	<p>S SimStruct representing an S-Function block.</p> <p>port Index of a port.</p> <p>dimsInfo Structure that specifies the signal dimensions supported by port.</p> <p>See <code>ssSetInputPortDimensionInfo</code> for a description of this structure.</p>
------------------	---

Description The Simulink engine calls this method with candidate dimensions `dimsInfo` for `port`. In C MEX S-functions, if the proposed dimensions are acceptable, the method sets the actual port dimensions, using `ssSetOutputPortDimensionInfo`. If they are unacceptable, the method generates an error via `ssSetErrorStatus`. This method is only valid for simulation. C MEX S-functions must enclose the method in a `#if defined(MATLAB_MEX_FILE)` statement.

Note This method can set the dimensions of any other input or output port whose dimensions derive from the dimensions of `port`.

By default, the engine calls this method only if it can fully determine the dimensionality of `port` from the port to which it is

connected. In C MEX S-functions, if the engine cannot completely determine the dimensionality from port connectivity, it invokes `mdlSetDefaultPortDimensionInfo`. If an S-function can fully determine the port dimensionality from partial information, set the option `SS_OPTION_ALLOW_PARTIAL_DIMENSIONS_CALL` in `mdlInitializeSizes`, using `ssSetOptions`. If this option is set, the engine invokes `mdlSetOutputPortDimensionInfo` even if it can only partially determine the dimensionality of the output port from connectivity.

The engine calls this method until all output ports with inherited dimensions have their dimensions specified.

Example

See `sfun_matadd.c` for an example of how to use this function.

See Also

`ssSetErrorStatus`, `ssSetOutputPortDimensionInfo`,
`SetOutputPortDimensions`

mdlSetOutputPortSampleTime

Purpose Set the sample time of an output port that inherits its sample time from the port to which it is connected

Required No

Languages C, C++

Syntax

```
#define MDL_SET_OUTPUT_PORT_SAMPLE_TIME
void mdlSetOutputPortSampleTime(SimStruct *S, int_T port,
    real_T sampleTime, real_T offsetTime)
```

Arguments

S
SimStruct representing an S-Function block.

port
Index of a port.

sampleTime
Inherited sample time for port.

offsetTime
Inherited offset time for port.

Description The Simulink engine calls this method with the sample time that port inherits from the port to which it is connected.

For C MEX S-functions, if the inherited sample time is acceptable, this method should set the sample time of port to the inherited sample time and offset time, using `ssSetOutputPortSampleTime` and `ssSetOutputPortOffsetTime`. If the sample time is unacceptable, this method generates an error via `ssSetErrorStatus`. This method is only valid for simulation, and must be enclosed in a `#if defined(MATLAB_MEX_FILE)` statement.

This method can set the sample time of any other input or output port whose sample time derives from the sample time of port, using `ssSetInputPortSampleTime` or `ssSetOutputPortSampleTime` in C MEX S-functions.

Normally, sample times are propagated forward; however, if sources feeding this block have inherited sample times, the engine might choose to back-propagate known sample times to this block. When back-propagating sample times, this method is called in succession for all inherited output port signals.

See `mdlSetInputPortSampleTime` for more information about when this method is called.

See Also

`ssSetOutputPortSampleTime`, `ssSetErrorStatus`,
`ssSetInputPortSampleTime`, `ssSetOutputPortSampleTime`,
`mdlSetInputPortSampleTime`, `SetOutputPortSampleTime`

mdlSetOutputPortWidth

Purpose Set the width of an output port that outputs 1-D (vector) signals

Required No

Languages C, C++

Syntax

```
#define MDL_SET_OUTPUT_PORT_WIDTH
void mdlSetOutputPortWidth(SimStruct *S, int_T port,
    int_T width)
```

Arguments

S SimStruct representing an S-Function block.

port Index of a port.

width Width of signal.

Description This method is called with the candidate width for a dynamically sized port. If the proposed width is acceptable, the method should go ahead and set the actual port width, using `ssSetOutputPortWidth`. If the size is unacceptable, an error should be generated via `ssSetErrorStatus`. Note that any other dynamically sized input or output ports whose widths are implicitly defined by virtue of knowing the width of the given port can also have their widths set via calls to `ssSetInputPortWidth` or `ssSetOutputPortWidth`. This method is only valid for simulation, and must be enclosed in a `#if defined(MATLAB_MEX_FILE)` statement.

See Also `ssSetInputPortWidth`, `ssSetOutputPortWidth`, `ssSetErrorStatus`

Purpose	Set the simulation state of the C MEX S-function by restoring the SimState.
Required	No
Languages	C, C++
Syntax	<pre>#define MDL_SIM_STATE void mdlSetSimState(SimStruct* S, const mxArray* in)</pre>
Arguments	<p>S SimStruct representing an S-Function block.</p> <pre>const mxArray* in</pre> <p>Any valid MATLAB data.</p>
Description	The Simulink engine invokes this custom method at the beginning of a simulation of the model containing S . Simulink sets the initial simulation state of the S-function to the SimState of the model.
Example	<pre>/* Function: mdlSetSimState * Abstract: * Unpack the MATLAB structure passed and restore it to * the RunTimeData structure */ static void mdlSetSimState(SimStruct* S, const mxArray* simSnap) { unsigned n = (unsigned)(ssGetInputPortWidth(S, 0)); RunTimeData_T* rtd = (RunTimeData_T*)ssGetPWorkValue(S, 0); /* Check and load the count value */ { const mxArray* cnt = mxGetField(simSnap, 0, fieldNames[0]);</pre>

mdlSetSimState

```
        ERROR_IF_NULL(S,cnt,
"Count field not found in simulation state");
        if ( mxIsComplex(cnt) ||
            !mxIsUint64(cnt) ||
            mxGetNumberOfElements(cnt) != 1 ) {
            ssSetErrorStatus(S, "Count field is invalid");
            return;
        }
        rtd->cnt = ((uint64_T*)(mxGetData(cnt)))[0];
    }
```

See Also

mdlInitializeConditions, mdlGetSimState, SetSimState

Purpose	Specify the sizes of the work vectors and create the run-time parameters required by this C MEX S-function
Required	No
Languages	C, C++
Syntax	<pre>#define MDL_SET_WORK_WIDTHS void mdlSetWorkWidths(SimStruct *S)</pre>
Arguments	S SimStruct representing an S-Function block.
Description	<p>The Simulink engine calls this optional method to enable this S-function to set the sizes of state and work vectors that it needs to store global data and to create run-time parameters (see “Run-Time Parameters” on page 8-8). The engine invokes this method after it has determined the input port width, output port width, and sample times of the S-function. This allows the S-function to size the state and work vectors based on the number and sizes of inputs and outputs and/or the number of sample times. This method specifies the state and work vector sizes via the macros <code>ssGetNumContStates</code>, <code>ssSetNumDiscStates</code>, <code>ssSetNumRWork</code>, <code>ssSetNumIWork</code>, <code>ssSetNumPWork</code>, <code>ssSetNumModes</code>, and <code>ssSetNumNonsampledZCs</code>.</p> <p>A C-MEX S-function needs to implement this method only if it does not know the sizes of all the work vectors it requires when the engine invokes the function’s <code>mdlInitializeSizes</code> method. If this S-function implements <code>mdlSetWorkWidths</code>, it should initialize the sizes of any work vectors that it needs to <code>DYNAMICALLY_SIZED</code> in <code>mdlInitializeSizes</code>, even for those whose exact size it knows at that point. The S-function should then specify the actual size in <code>mdlSetWorkWidths</code>. This method is only valid for simulation, and must be enclosed in a <code>#if defined(MATLAB_MEX_FILE)</code> statement.</p>

mdlSetWorkWidths

Example

For a full example of a C MEX S-function using DWork vectors, see the file `sfun_rtdwork.c` used in the Simulink model `sfcndemo_sfund_rtdwork`.

See Also

`mdlInitializeSizes`, `PostPropagationSetup`

Purpose	Respond to a pause or resumption of the simulation of the model that contains this C MEX S-function
Required	No
Languages	C, C++
Syntax	<pre>#define MDL_SIM_STATUS_CHANGE void mdlSimStatusChange(SimStruct *S, ssSimStatusChangeType simStatus)</pre>
Arguments	<p>S SimStruct representing an S-Function block.</p> <p>simStatus Status of the simulation, either SIM_PAUSE or SIM_CONTINUE.</p>
Description	The Simulink engine calls this routine when a simulation of the model containing S pauses or resumes. This method is only valid for simulation. C MEX S-functions must enclose the method in a #if defined(MATLAB_MEX_FILE) statement.
Example	<pre>#if defined(MATLAB_MEX_FILE) #define MDL_SIM_STATUS_CHANGE static void mdlSimStatusChange(SimStruct *S, ssSimStatusChangeType simStatus) { if (simStatus == SIM_PAUSE) { ssPrintf("Pause has been called! \n"); } else if (simStatus == SIM_CONTINUE) { ssPrintf("Continue has been called! \n"); } } #endif</pre>
See Also	SimStatusChange

mdlStart

Purpose	Initialize the state vectors of this C MEX S-function
Required	No
Languages	C, C++
Syntax	<pre>#define MDL_START void mdlStart(SimStruct *S)</pre>
Arguments	S SimStruct representing an S-Function block.
Description	<p>The Simulink engine invokes this optional method at the beginning of a simulation. The method performs initialization activities that this S-function requires only once, such as allocating memory, setting up user data, or initializing states.</p> <p>If your S-function resides in an enabled subsystem and needs to reinitialize its states every whenever the subsystem is enabled, use <code>mdlInitializeConditions</code> to initialize the state values, instead of <code>mdlStart</code>.</p> <p>In C MEX S-functions, use <code>ssGetContStates</code> and/or <code>ssGetDiscStates</code> to get the states.</p>
Example	See <code>sfun_directlook.c</code> for an example of how to use this function.
See Also	<code>mdlInitializeConditions</code> , <code>ssGetContStates</code> , <code>ssGetDiscStates</code> , <code>Start</code>

Purpose	Perform any actions required at termination of the simulation
Required	Yes
Languages	C, C++
Syntax	<pre>void mdlTerminate(SimStruct *S)</pre>
Arguments	S SimStruct representing an S-Function block.
Description	<p>This method performs any actions, such as freeing of memory, that must be performed when the simulation is terminated or when an S-Function block is destroyed (e.g., when it is deleted from a model).</p> <p>In C MEX S-functions, the <code>mdlTerminate</code> method is called after selecting Simulation > Update Diagram or after a simulation for which <i>one</i> of the following conditions is met:</p> <ul style="list-style-type: none">• <code>mdlStart</code> has run and the S-function does not have any <code>mdlInitializeConditions</code> method defined.• <code>mdlInitializeConditions</code> has run. <p>In addition, if the <code>SS_OPTION_CALL_TERMINATE_ON_EXIT</code> option is set for a given S-function, and if <code>mdlInitializeSizes</code> is called, then the user is guaranteed that Simulink will call <code>mdlTerminate</code>. One reason to set the <code>SS_OPTION_CALL_TERMINATE_ON_EXIT</code> option is to allocate memory in <code>mdlInitializeSizes</code> rather than wait until <code>mdlStart</code>.</p> <p>Note that Simulink calls <code>mdlInitializeSizes</code> under a number of circumstances, including compilation and simulation. Simulink will also call <code>mdlInitializeSizes</code> during model editing if you perform an operation such as the setting of parameters.</p> <p>In C MEX S-functions, use the <code>UNUSED_ARG</code> macro if the <code>mdlTerminate</code> function does not perform any actions that require the <code>SimStruct S</code> to</p>

mdlTerminate

indicate that the `S` input argument is required, but not used in the body of the callback. To do this, insert the line

```
UNUSED_ARG(S)
```

after any declarations in `mdlTerminate`.

Note If you have Simulink Coder, when generating code for a noninlined C MEX S-function that contains this method, make sure the method is not wrapped in a `#if defined(MATLAB_MEX_FILE)` statement. For example:

```
#if defined(MATLAB_MEX_FILE)
static void mdlTerminate(SimStruct *S)
{
    /* Add mdlTerminate code here */
}
#endif
```

The `define` statement makes the `mdlTerminate` method available only to a MATLAB MEX file. If the S-function is not inlined, Simulink Coder cannot use this method, resulting in link or run-time errors.

Example

Suppose your S-function allocates blocks of memory in `mdlStart` and saves pointers to the blocks in a `PWork` vector. The following code fragment would free this memory.

```
{
    int i;
    for (i = 0; i < ssGetNumPWork(S); i++) {
        if (ssGetPWorkValue(S,i) != NULL) {
            free(ssGetPWorkValue(S,i));
        }
    }
}
```

See Also `ssSetOptions`, `Terminate`

mdlUpdate

Purpose Update a block's states

Required No

Languages C, C++

Syntax

```
#define MDL_UPDATE
void mdlUpdate(SimStruct *S, int_T tid)
```

Arguments

S
SimStruct representing an S-Function block.

tid
Task ID.

Description The Simulink engine invokes this optional method at each major simulation time step. The method should compute the S-function's states at the current time step and store the states in the S-function's state vector. The method can also perform any other tasks that the S-function needs to perform at each major time step.

Use this code if your S-function has one or more discrete states or does *not* have direct feedthrough.

The reason for this is that most S-functions that do not have discrete states but do have direct feedthrough do not have update functions. Therefore, the engine is able to eliminate the need for the extra call in these circumstances.

If your C MEX S-function needs to have its `mdlUpdate` routine called and it does not satisfy either of the above two conditions, specify that it has a discrete state, using the `ssSetNumDiscStates` macro in the `mdlInitializeSizes` function.

In C MEX S-functions, the `tid` (task ID) argument specifies the task running when the `mdlOutputs` routine is invoked. You can use this argument in the `mdlUpdate` routine of a multirate S-Function block

to encapsulate task-specific blocks of code (see “Multirate S-Function Blocks” on page 8-44).

Use the `UNUSED_ARG` macro if your C MEX S-function does not contain task-specific blocks of code to indicate that the `tid` input argument is required but not used in the body of the callback. To do this, insert the line

```
UNUSED_ARG(tid)
```

after the declarations in `mdlUpdate`.

Note If you have Simulink Coder, when generating code for a noninlined C MEX S-function that contains this method, make sure the method is not wrapped in a `#if defined(MATLAB_MEX_FILE)` statement. For example:

```
#define MDL_UPDATE
#if defined(MDL_UPDATE) && defined(MATLAB_MEX_FILE)
static void mdlUpdate(SimStruct *S, int_T tid)
{
    /* Add mdlUpdate code here */
}
#endif
```

The `define` statement makes the `mdlUpdate` method available only to a MATLAB MEX file. If the S-function is not inlined, Simulink Coder cannot use this method, resulting in link or run-time errors.

Example

For an example that uses this function to update discrete states, see `dsfunc.c`. For an example that uses this function to update the transfer function coefficients of a time-varying continuous transfer function, see `stvctf.c`.

See Also

`mdlDerivatives`, `ssGetContStates`, `ssGetDiscStates`, `Update`

mdlZeroCrossings

Purpose Update zero-crossing vector

Required No

Languages C, C++

Syntax

```
#define MDL_ZERO_CROSSINGS  
void mdlZeroCrossings(SimStruct *S)
```

Arguments S
SimStruct representing an S-Function block.

Description An S-function needs to provide this optional method only if it does zero-crossing detection. Implementing zero-crossing detection typically requires using the zero-crossing and mode work vectors to determine when a zero crossing occurs and how the S-function's outputs should respond to this event. The `mdlZeroCrossings` method should update the S-function's zero-crossing vector, using `ssGetNonsampledZCs`.

You can use the optional `mdlZeroCrossings` routine when your S-function has registered the `CONTINUOUS_SAMPLE_TIME` and has nonsampled zero crossings (`ssGetNumNonsampledZCs(S) > 0`). The `mdlZeroCrossings` routine is used to provide the Simulink engine with signals that are to be tracked for zero crossings. These are typically

- Continuous signals entering the S-function
- Internally generated signals that cross zero when a discontinuity would normally occur in `mdlOutputs`

Thus, the zero-crossing signals are used to locate the discontinuities and end the current time step at the point of the zero crossing. To provide the engine with zero-crossing signals, `mdlZeroCrossings` updates the `ssGetNonsampledZCs(S)` vector.

Example For an example, see `sfun_zc_sat.c`. A detailed description of this example can be found in “Zero Crossings” on page 8-50.

See Also mdlInitializeSizes, ssGetNonsampledZCs

Outputs

Purpose	Compute the signals that this MATLAB S-function block emits
Required	Yes
Language	MATLAB
Syntax	Outputs(s)
Arguments	s Instance of <code>Simulink.MSFcnRunTimeBlock</code> class representing the Level-2 MATLAB S-Function block.
Description	<p>The Simulink engine invokes this required method at each simulation time step. In a Level-2 MATLAB S-function, the <code>Outputs</code> method calculates the S-function's outputs at the current time step and store the results in the run-time object's <code>OutputPort(n).Data</code> property. In addition, for S-functions with a variable sample time, the <code>Outputs</code> method computes the next sample time hit.</p> <p>Use the run-time object method <code>IsSampleHit</code> to determine if the current simulation time is one at which a task handled by this block is active. For port-based sample times, use the <code>IsSampleHit</code> property of the run-time object's <code>InputPort</code> or <code>OutputPort</code> methods to determine if the port produces outputs or accepts inputs at the current simulation time step.</p> <p>Set the run-time object's <code>NextTimeHit</code> property to specify the time of the next sample hit for variable sample-time S-functions.</p>
See Also	<code>Simulink.RunTimeBlock</code> , <code>Simulink.MSFcnRunTimeBlock</code> , <code>mdlOutputs</code>

Purpose	Specify the sizes of the work vectors and create the run-time parameters required by this MATLAB S-function
Required	No
Language	MATLAB
Syntax	PostPropagationSetup(s)
Arguments	<p>s</p> <p>Instance of Simulink.MSFcnRunTimeBlock class representing the Level-2 MATLAB S-Function block.</p>
Description	<p>The Simulink engine calls this optional method to enable this S-function to set the sizes of state and work vectors that it needs to store global data and to create run-time parameters (see “Run-Time Parameters” on page 8-8). The engine invokes this method after it has determined the input port width, output port width, and sample times of the S-function. This allows the S-function to size the state and work vectors based on the number and sizes of inputs and outputs and/or the number of sample times.</p> <p>A Level-2 MATLAB S-function must implement this method if any DWork vectors are used in the S-function. In the case of MATLAB S-functions, this method sets the number of DWork vectors and initializes their attributes. For example, the following code in the PostPropagationSetup method specifies the usage for the first DWork vector:</p> <pre>s.DWork(1).Usage = type;</pre> <p>where s is an instance of the Simulink.MSFcnRunTimeBlock class representing the Level-2 MATLAB S-Function block and <i>type</i> is one of the following:</p> <ul style="list-style-type: none">• DWork

PostPropagationSetup

- DState
- Scratch
- Mode

Example

For a full example of a Level-2 MATLAB S-function using DWork vectors, see the file `adapt_1ms.m` used in the Simulink model `sldemo_msfcn_1ms`.

See Also

`setup`, `Simulink.RunTimeBlock`, `mdlSetWorkWidths`

Purpose	Process the MATLAB S-function's parameters
Required	No
Language	MATLAB
Syntax	ProcessParameters(s)
Arguments	s Instance of Simulink.MSFcnRunTimeBlock class representing the Level-2 MATLAB S-Function block.
Description	<p>This is an optional routine that the Simulink engine calls after <code>CheckParameters</code> changes and verifies parameters. The processing is done at the top of the simulation loop when it is safe to process the changed parameters. This function is only valid for simulation.</p> <p>The purpose of this routine is to process newly changed parameters. An example is to cache parameter changes in work vectors. The engine does not call this routine when it is used with the Simulink Coder product. Therefore, if you use this routine in an S-function designed for use with the Simulink Coder product, you must write your S-function so that it doesn't rely on this routine. To do this, you must inline your S-function by using the Target Language Compiler. For information on inlining S-functions, see "Inlining S-Functions".</p>
See Also	<code>CheckParameters</code> , <code>Simulink.MSFcnRunTimeBlock</code> , <code>mdlProcessParameters</code>

Projection

Purpose	Perturb the solver's solution of a system's states to better satisfy time-invariant solution relationships
Required	No
Language	MATLAB
Syntax	Projection(s)
Arguments	s Instance of Simulink.MSFcnRunTimeBlock class representing the Level-2 MATLAB S-Function block.

Description This method is intended for use with S-functions that model dynamic systems whose states satisfy time-invariant relationships, such as those resulting from mass or energy conservation or other physical laws. The Simulink engine invokes this method at each time step after the model's solver has computed the S-function's states for that time step. Typically, slight errors in the numerical solution of the states cause the solutions to fail to satisfy solution invariants exactly. Your `Projection` method can compensate for the errors by perturbing the states so that they more closely approximate solution invariants at the current time step. As a result, the numerical solution adheres more closely to the ideal solution as the simulation progresses, producing a more accurate overall simulation of the system modeled by your S-function.

Your `Projection` method's perturbations of system states must fall within the solution error tolerances specified by the model in which the S-function is embedded. Otherwise, the perturbations may invalidate the solver's solution. It is up to your `Projection` method to ensure that the perturbations meet the error tolerances specified by the model. See "Perturb System States Using a Solution Invariant" on page 9-95 for a simple method for perturbing a system's states. The following articles describe more sophisticated perturbation methods that your `mdlProjection` method can use.

- C.W. Gear, “Maintaining Solution Invariants in the Numerical Solution of ODEs,” *Journal on Scientific and Statistical Computing*, Vol. 7, No. 3, July 1986.
- L.F. Shampine, “Conservation Laws and the Numerical Solution of ODEs I,” *Computers and Mathematics with Applications*, Vol. 12B, 1986, pp. 1287–1296.
- L.F. Shampine, “Conservation Laws and the Numerical Solution of ODEs II,” *Computers and Mathematics with Applications*, Vol. 38, 1999, pp. 61–72.

Example

Perturb System States Using a Solution Invariant

Here is a simple, Taylor-series-based approach to perturbing a system’s states. Suppose your S-function models a dynamic system having a solution invariant, $g(X, t)$, i.e., g is a continuous, differentiable function of the system states, X , and time, t , whose value is constant with time. Then

$$X_n \cong X_n^* + J_n^T (J_n J_n^T)^{-1} R_n$$

where

- X_n is the system’s ideal state vector at the solver’s current time step
- X_n^* is the approximate state vector computed by the solver at the current time step
- J_n is the Jacobian of the invariant function evaluated at the point in state space specified by the approximate state vector at the current time step:

$$J_n = \frac{\partial g}{\partial X}(X_n^*, t_n)$$

- t_n is the time at the current time step

Projection

- R_n is the residual (difference) between the invariant function evaluated at X_n and X_n^* at the current time step:

$$R_n = g(X_n, t_n) - g(X_n^*, t_n)$$

Note The value of $g(X_n, t_n)$ is the same at each time step and is known by definition.

Given a continuous, differentiable invariant function for the system that your S-function models, this formula allows your S-function's `mdlProjection` method to compute a perturbation

$$J_n^T (J_n J_n^T)^{-1} R_n$$

of the solver's numerical solution, X_n^* , that more closely matches the ideal solution, X_n , keeping the S-function's solution from drifting from the ideal solution as the simulation progresses.

MATLAB Example

This example illustrates how the perturbation method outlined in the previous section can keep a model's numerical solution from drifting from the ideal solution as a simulation progresses. Consider the following model, `mdlProjectionEx1`:

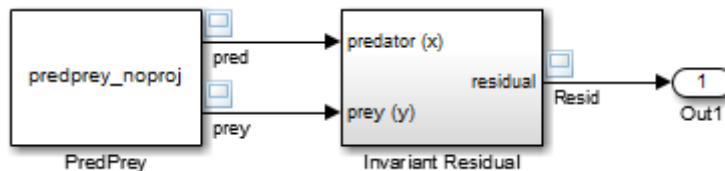

The `PredPrey` block references an S-function, `predprey_noproj.m`, that uses the Lotka-Volterra equations

$$\begin{aligned}\dot{x} &= ax(1 - y) \\ \dot{y} &= -cy(1 - x)\end{aligned}$$

to model predator-prey population dynamics, where $x(t)$ is the population density of the predators and $y(t)$ is the population density of prey. The ideal solution to the predator-prey ODEs satisfies the time-invariant function

$$x^{-c} e^{cx} y^{-a} e^{ay} = d$$

where a , c , and d are constants. The S-function assumes $a = 1$, $c = 2$, and $d = 121.85$.

The Invariant Residual block in this model computes the residual between the invariant function evaluated along the system's ideal trajectory through state space and its simulated trajectory:

$$R_n = d - x_n^{-c} e^{cx_n} y_n^{-a} e^{ay_n}$$

where x_n and y_n are the values computed by the model's solver for the predator and prey population densities, respectively, at the current time step. Ideally, the residual should be zero throughout simulation of the model, but simulating the model reveals that the residual actually strays considerably from zero:

Projection

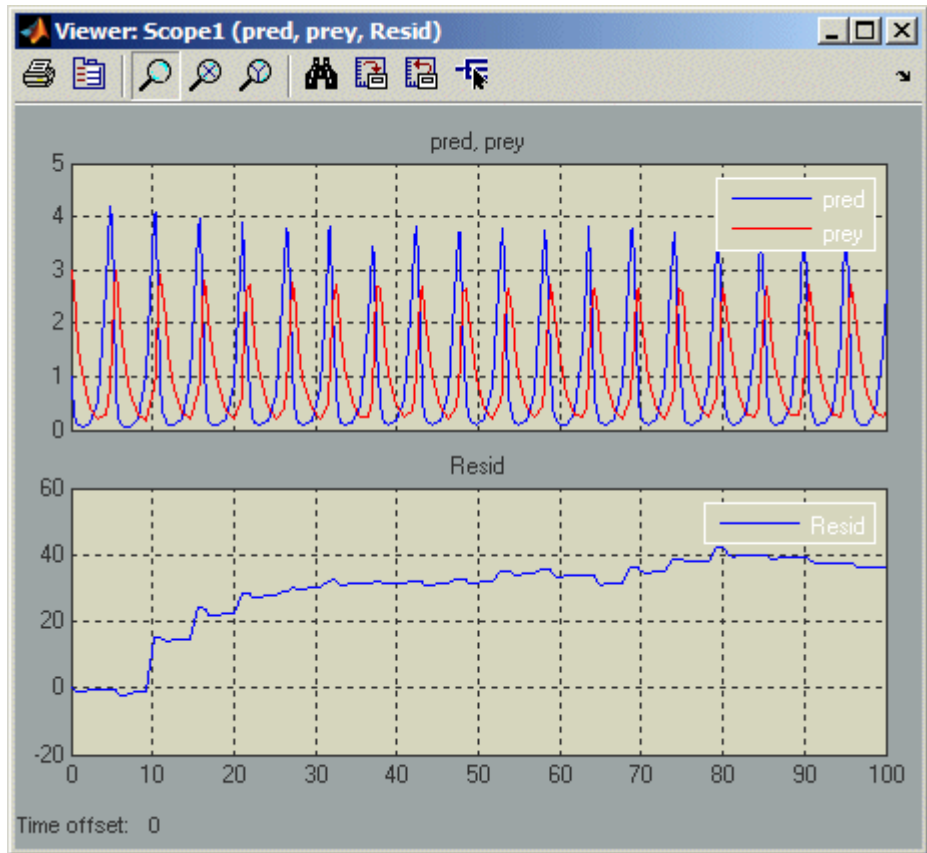

Now consider the following model, mdlProjectionEx2:

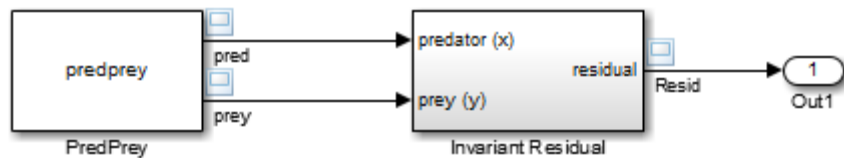

This model is the same as the previous model, except that its S-function, `predprey.m`, includes a `mdlProjection` method that uses the perturbation approach outlined in “Perturb System States Using a Solution Invariant” on page 9-95 to compensate for numerical drift. As a result, the numerical solution more closely tracks the ideal solution as the simulation progresses as demonstrated by the residual signal, which remains near or at zero throughout the simulation:

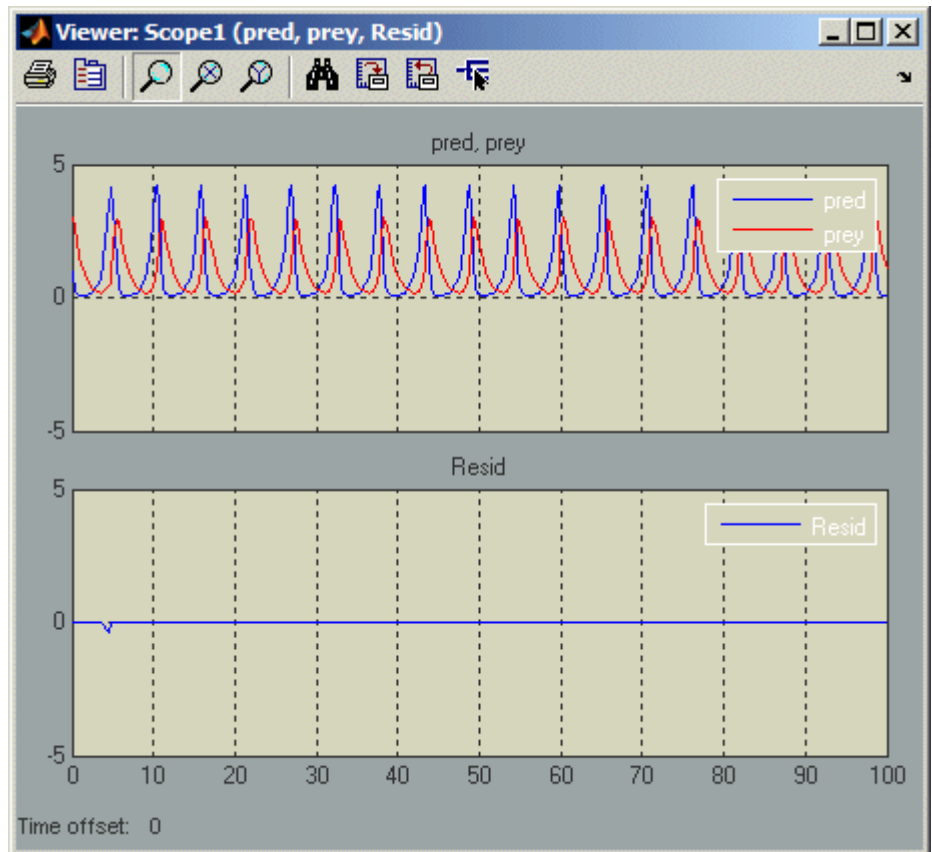

See Also

`Simulink.MSFcnRunTimeBlock`, `mdlProjection`,

SetInputPortComplexSignal

Purpose	Set the numeric types (real, complex, or inherited) of the signals accepted by an input port
Required	No
Language	MATLAB
Syntax	<code>SetInputPortComplexSignal(s, port, csig)</code>
Arguments	<p>s Instance of <code>Simulink.MSFcnRunTimeBlock</code> class representing the Level-2 MATLAB S-Function block.</p> <p>port Integer value specifying index of port to be set.</p> <p>csig Integer value specifying whether the port accepts real (<code>false</code> or <code>0</code>) or complex (<code>true</code> or <code>1</code>) signals.</p>
Description	<p>The Simulink engine calls this routine to set the input port numeric type for inputs that have this attribute set to <code>COMPLEX_INHERITED</code>. The input <code>csig</code> is the proposed numeric type for this input port. This method is only valid for simulation.</p> <p>The S-function must check whether the proposed numeric type is a valid type for the specified port. If it is valid, level-2 MATLAB S-functions set the numeric type of the specified input port using the line:</p> <pre>s.InputPort(port).Complexity = csig;</pre> <p>The S-function can also set the numeric types of other input and output ports with inherited numeric types. The engine reports an error if the S-function changes the numeric type of a port whose numeric type is known.</p>

If the S-function does not implement this routine, the engine assumes that the S-function accepts a real or complex signal and sets the input port numeric type to the specified value.

The engine calls this method until all input ports with inherited numeric types have their numeric types specified.

See Also

`Simulink.MSFcnRunTimeBlock`, `Simulink.BlockPortData`,
`mdlSetInputPortComplexSignal`

SetInputPortDataType

Purpose Set the data types of the signals accepted by an input port

Required No

Language MATLAB

Syntax `SetInputPortDataType(s, port, id)`

Arguments

s
Instance of `Simulink.MSFcnRunTimeBlock` class representing the Level-2 MATLAB S-Function block.

port
Integer value specifying index of port to be set.

id
Integer value specifying ID of port's data type. Use `s.getDatatypeName(id)` to get the data type's name.

Description The Simulink engine calls this routine to set the data type of `port` when `port` has an inherited data type. The data type `id` is the proposed data type for this port. Data type IDs for the built-in data types can be found in `simstruc_types.h`. This method is only valid for simulation.

The S-function must check whether the specified data type is a valid data type for the specified port. If it is a valid data type, Level-2 MATLAB S-functions set the data type of the input port using the line:

```
s.InputPort(port).DatatypeID = id;
```

The S-function can also set the data types of other input and output ports if they are unknown. The engine reports an error if the S-function changes the data type of a port whose data type has been set.

If the block does not implement this routine, the engine assumes that the block accepts any data type and sets the input port data type to the specified value.

The engine calls this method until all input ports with inherited data types have their data types specified.

See Also

`Simulink.MSFcnRunTimeBlock`, `Simulink.BlockPortData`,
`mdlSetInputPortDataType`

SetInputPortDimensions

Purpose	Set the dimensions of the signals accepted by an input port
Required	No
Languages	MATLAB
Syntax	<code>SetInputPortDimensions(s, port, dimsInfo)</code>
Arguments	<p><code>s</code> Instance of <code>Simulink.MSFcnRunTimeBlock</code> class representing the Level-2 MATLAB S-Function block.</p> <p><code>port</code> Integer value specifying index of port to be set.</p> <p><code>dimsInfo</code> Array that specifies the signal dimensions supported by the port, e.g., <code>[5]</code> for a 5-element vector signal or <code>[3 3]</code> for a 3-by-3 matrix signal.</p>

Description The Simulink engine calls this method during dimension propagation with candidate dimensions `dimsInfo` for `port`.

A Level-2 MATLAB S-function sets the input port dimensions using the line

```
s.InputPort(port).Dimensions = dimsInfo;
```

This method is only valid for simulation.

Note This method can set the dimensions of any other input or output port whose dimensions derive from the dimensions of `port`.

By default, the engine calls this method only if it can fully determine the dimensionality of `port` from the port to which it is connected.

The engine calls this method until all input ports with inherited dimensions have their dimensions specified.

See Also

SetOutputPortDimensions, Simulink.MSFcnRunTimeBlock,
Simulink.BlockPortData, mdlSetInputPortDimensionInfo

SetInputPortDimensionsMode

Purpose	Propagate the dimensions mode
Required	No
Language	MATLAB
Syntax	<code>SetInputPortDimensionsMode(s, port, dm)</code>
Arguments	<p><code>s</code> Instance of <code>Simulink.MSFcnRunTimeBlock</code> class representing the Level-2 MATLAB S-Function block.</p> <p><code>port</code> Integer value specifying index of port to be set.</p> <p><code>dm</code> Integer value representing the dimensions mode of the port.</p>
Description	The Simulink engine calls this optional method to enable this S-function to set the dimensions mode of the input port indexed by <code>portIdx</code> .
See Also	<code>SetInputPortDimensions</code> , <code>Simulink.MSFcnRunTimeBlock</code> , <code>Simulink.BlockPortData</code> , <code>mdlSetInputPortDimensionsModeFcn</code>

Purpose	Specify whether an input port accepts frame data
Required	No
Language	MATLAB
Syntax	<code>SetInputPortSamplingMode(s, port, mode)</code>
Arguments	<p><code>s</code> Instance of <code>Simulink.MSFcnRunTimeBlock</code> class representing the Level-2 MATLAB S-Function block.</p> <p><code>port</code> Integer value specifying the index of port whose sampling mode is to be set.</p> <p><code>mode</code> Integer value specifying the sampling mode of the port (0 = sample, 1 = frame).</p>
Description	<p>This method is called with the candidate frame setting for an input port. For Level-2 MATLAB S-functions, if the value of <code>mode</code> is acceptable, this method sets the sampling mode using the line</p> <pre>s.InputPort(port).SamplingMode = mode;</pre> <p>The Simulink engine calls this method until all input ports with inherited frame settings have their frame settings specified.</p> <p>The use of frame-based signals (<code>mode</code> has a value of 1 or <code>frameData</code> has a value of <code>FRAME_YES</code>) requires a DSP System Toolbox license.</p>
See Also	<code>Simulink.MSFcnRunTimeBlock</code> , <code>Simulink.BlockPortData</code> , <code>mdlSetInputPortFrameData</code>

SetInputPortSampleTime

Purpose Set the sample time of an input port that inherits its sample time from the port to which it is connected

Required No

Language MATLAB

Syntax `SetInputPortSampleTime(s, port, time)`

Arguments

s
Instance of `Simulink.MSFcnRunTimeBlock` class representing the Level-2 MATLAB S-Function block.

port
Integer value specifying the index of port whose sampling mode is to be set.

time
Two-element array, [`period` `offset`], that specifies the period and offset of the times that this port samples its input.

Description The Simulink engine invokes this method with the sample time that port inherits from the port to which it is connected.

For Level-2 MATLAB S-functions, if the inherited sample time is acceptable, this method sets the sample time and offset time using the line

```
s.InputPort(port).SampleTime = time;
```

The engine calls this method until all input ports with inherited sample times are specified.

When inherited port-based sample times are specified, the sample time is guaranteed to be one of the following where $0.0 < \text{period} < \text{inf}$ and $0.0 \leq \text{offset} < \text{period}$.

	Sample Time	Offset Time
Continuous	0.0	0.0
Discrete	period	offset

Constant, triggered, and variable-step sample times are not propagated to S-functions with port-based sample times.

Generally `SetInputPortSampleTime` is called once per port with the input port sample time. However, there can be cases where this function is called more than once. This happens when the simulation engine is converting continuous sample times to continuous but fixed in minor steps sample times. When this occurs, the original values of the sample times specified in `setup` are restored before this method is called again.

The final sample time specified at the port can be different from (but equivalent to) the sample time specified by this method. This occurs when

- The model uses a fixed-step solver and the port has a continuous but fixed in minor step sample time. In this case, the Simulink engine converts the sample time to the fundamental sample time for the model.
- The engine adjusts the sample time to be as numerically sound as possible. For example, the engine converts `[0.249999999999999, 0]` to `[0.25, 0]`.

The S-function can examine the final sample times in `setup`.

See Also

`setup`, `Simulink.MSFcnRunTimeBlock`, `mdlSetInputPortSampleTime`

SetOutputPortComplexSignal

Purpose	Set the numeric types (real, complex, or inherited) of the signals accepted by an output port
Required	No
Language	MATLAB
Syntax	<code>SetOutputPortComplexSignal(s, port, csig)</code>
Arguments	<p>s Instance of <code>Simulink.MSFcnRunTimeBlock</code> class representing the Level-2 MATLAB S-Function block.</p> <p>port Integer value specifying the index of port to be set.</p> <p>csig Integer value specifying whether the port produces real (0) or complex (1) signals.</p>

Description The Simulink engine calls this routine to set the output port numeric type for outputs that have this attribute set to `COMPLEX_INHERITED`. The input argument `csig` is the proposed numeric type for this output port. The S-function must check whether the specified numeric type is a valid type for the specified port.

If it is valid, Level-2 MATLAB S-functions set the numeric type of the specified output port using the line

```
s.OutputPort(port).Complexity = csig;
```

The S-function can also set the numeric types of other input and output ports with unknown numeric types. The engine reports an error if the S-function changes the numeric type of a port whose numeric type is known.

If the S-function does not implement this routine, the engine assumes that the S-function accepts a real or complex signal and sets the output port numeric type to the specified value.

The engine calls this method until all output ports with inherited numeric types have their numeric types specified.

Example

See `sdotproduct.c` for an example of how to use this function.

See Also

`Simulink.MSFcnRunTimeBlock` , `Simulink.BlockPortData`,
`mdlSetOutputPortComplexSignal`

SetOutputPortDataType

Purpose Set the data type of the signals emitted by an output port

Required No

Language MATLAB

Syntax `SetOutputPortDataType(s, port, id)`

Arguments

s
Instance of `Simulink.MSFcnRunTimeBlock` class representing the Level-2 MATLAB S-Function block.

port
Integer value specifying index of port to be set.

id
Integer value specifying ID of port's data type. Use `s.getDatatypeName(id)` to get the data type's name.

Description The Simulink engine calls this routine to set the data type of `port` when `port` has an inherited data type. The data type ID `id` is the proposed data type for this port. Data type IDs for the built-in data types can be found in `simstruc_types.h`. The S-function must check whether the specified data type is a valid data type for the specified port.

If it is a valid data type, Level-2 MATLAB S-functions set the data type of the output port using the line

```
s.OutputPort(port).DatatypeID = id;
```

The S-function can also set the data types of other input and output ports if their data types have not been set. The engine reports an error if the S-function changes the data type of a port whose data type has been set.

If the block does not implement this method, the engine assumes that the block supports any data type and sets the output port data type to the specified value.

The engine calls this method until all output ports with inherited data types have their data types specified.

See Also

`Simulink.MSFcnRunTimeBlock` , `Simulink.BlockPortData`,
`mdlSetOutputPortDataType`

SetOutputPortDimensions

Purpose	Set the dimensions of the signals accepted by an output port
Required	No
Language	MATLAB
Syntax	<code>SetOutputPortDimensions(s, port, dimsInfo)</code>
Arguments	<p><code>s</code> Instance of <code>Simulink.MSFcnRunTimeBlock</code> class representing the Level-2 MATLAB S-Function block.</p> <p><code>port</code> Integer value specifying the index of the port to be set.</p> <p><code>dimsInfo</code> Array that specifies the signal dimensions supported by the port, e.g., <code>[5]</code> for a 5-element vector signal or <code>[3 3]</code> for a 3-by-3 matrix signal.</p>
Description	<p>The Simulink engine calls this method with candidate dimensions <code>dimsInfo</code> for <code>port</code>.</p> <p>A Level-2 MATLAB S-function sets the output port dimensions using the line</p> <pre>s.OutputPort(port).Dimensions = dimsInfo;</pre>

Note This method can set the dimensions of any other input or output port whose dimensions derive from the dimensions of `port`.

By default, the engine calls this method only if it can fully determine the dimensionality of `port` from the port to which it is connected.

The engine calls this method until all output ports with inherited dimensions have their dimensions specified.

Example

See `sfun_matadd.c` for an example of how to use this function.

See Also

`SetInputPortDimensions`, `Simulink.MSFcnRunTimeBlock` ,
`Simulink.BlockPortData`, `mdlSetOutputPortDimensionInfo`

SetOutputPortSampleTime

Purpose Set the sample time of an output port that inherits its sample time from the port to which it is connected

Required No

Language MATLAB

Syntax `SetOutputPortSampleTime(s, port, time)`

Arguments

s
Instance of `Simulink.MSFcnRunTimeBlock` class representing the S-Function block.

port
Integer value specifying the index of port whose sampling mode is to be set.

time
Two-element array, `[period offset]`, that specifies the period and offset of the times that this port produces output.

Description The Simulink engine calls this method with the sample time that port inherits from the port to which it is connected.

For Level-2 MATLAB S-functions, if the inherited sample time is acceptable, this method sets the sample time and offset time using the line

```
s.OutputPort(port).SampleTime = time;
```

This method can set the sample time of any other input or output port whose sample time derives from the sample time of `port`, setting the `SampleTime` property of the `Simulink.BlockPortData` object associated with the port in Level-2 MATLAB S-functions.

Normally, sample times are propagated forward; however, if sources feeding this block have inherited sample times, the engine might

choose to back-propagate known sample times to this block. When back-propagating sample times, this method is called in succession for all inherited output port signals.

See `SetInputPortSampleTime` for more information about when this method is called.

See Also

`SetInputPortSampleTime`, `Simulink.MSFcnRunTimeBlock`,
`Simulink.BlockPortData`, `mdlSetOutputPortSampleTime`

SetSimState

Purpose	Set the simulation state of the MATLAB S-function by restoring the SimState.
Required	No
Language	MATLAB
Syntax	SetSimState(s, in)
Arguments	<p>s Instance of Simulink.MSFcnRunTimeBlock class representing the Level-2 MATLAB S-Function block.</p> <p>in The MATLAB data of type returned by GetSimState.</p>
Description	The Simulink engine invokes this custom method at the beginning of a simulation of the model containing S . Simulink sets the initial simulation state of the S-function to the SimState of the model.
See Also	InitializeConditions, GetSimState, mdlSetSimState

Purpose	Specify the number of inputs, outputs, states, parameters, and other characteristics of the MATLAB S-function
Required	Yes
Language	MATLAB
Syntax	setup(s)
Arguments	<p>s</p> <p>Instance of Simulink.MSFcnRunTimeBlock class representing the Level-2 MATLAB S-Function block.</p>
Description	<p>This is the first S-function callback methods that the Simulink engine calls.</p> <p>The Level-2 MATLAB S-function <code>setup</code> method performs nearly the same tasks as the C MEX S-function <code>mdlInitializeSizes</code> method, with two significant differences. The <code>setup</code> method does not initialize discrete state information, but it does specify the block sample times, eliminating the need for an <code>mdlInitializeSampleTimes</code> method. Use the following properties and methods of the run-time object <code>s</code> to configure the S-function:</p> <ul style="list-style-type: none"> • Specify the number of parameters that this S-function supports, using <code>s.NumDialogPrms</code>. Use <code>s.DialogPrmsTunable</code> to set the tunability of each dialog parameter. When a parameter has been specified as not tunable, the Simulink engine issues an error during simulation (or when in external mode when using the Simulink Coder product) if an attempt is made to change the parameter. • Specify the number of continuous states that this function has, using <code>s.NumContStates</code>. Specify discrete state information in the <code>PostPropagationSetup</code> method using a <code>DWork</code> vector. • Configure the block's input ports, including:

- Specify the number of input ports that this S-function has, using `s.NumInputPorts`.
- Specify the dimensions of the i th input port, using `s.InputPort(i).Dimensions`.
- If using port-based sample times, specify the sample time of the i th input port, using `s.InputPort(i).SampleTime`.
- For each input port, specify whether it has direct feedthrough, using `s.InputPort(i).DirectFeedthrough`.

A port has direct feedthrough if the input is used in the `Outputs` method to calculate the output or the next sample time, for an S-function with a variable sample time. The direct feedthrough flag for each input port can be set to either 1=yes or 0=no. It should be set to 1 if the input, `u`, is used in the `Outputs` method. Setting the direct feedthrough flag to 0 tells the engine that `u` is not used in this S-function method. Violating this leads to unpredictable results.

See `Simulink.BlockData` and its parent and children classes for a list of all the properties and methods associated with a Level-2 MATLAB S-function input port.

- Configure the block's output ports, including:
 - Specify the number of output ports that the block has, using `s.NumOutputPorts`.
 - Specify the dimensions of the i th output port, using `s.OutputPort(i).Dimensions`.
 - If using port-based sample times, specify the sample time of the i th output port, using `s.OutputPort(i).SampleTime`.
- Set the block-based sample times (i.e., sample rates), using `s.SampleTimes`.

See “Sample Times” on page 8-32 for a complete discussion of sample time issues.

For multirate S-functions, the suggested approach to setting sample times is via the port-based sample times method. When you create a multirate S-function, you must take care to verify that, when slower tasks are preempted, your S-function correctly manages data so as to avoid race conditions. When port-based sample times are specified, the block cannot inherit a constant sample time at any port.

See “Using the setup Method” on page 3-8 for additional information and examples using the setup method.

Dynamically Sized Block Features

You can set the parameters NumContStates, NumDiscStates, NumInputs, NumOutputs, NumRWork, NumIWork, NumPWork, NumModes, and NumNonsampledZCs to a fixed nonnegative integer or tell the Simulink engine to size them dynamically:

- `DYNAMICALLY_SIZED` -- Sets lengths of states, work vectors, and so on to values inherited from the driving block. It sets widths to the actual input widths, according to the scalar expansion rules unless you use `mdlSetWorkWidths` to set the widths.
- 0 or positive number -- Sets lengths (or widths) to the specified values. The default is 0.

See Also

`Simulink.BlockData`, `Simulink.MSFcnRunTimeBlock`,
`mdlInitializeSizes`, `mdlInitializeSampleTimes`

SimStatusChange

Purpose	Respond to a pause or resumption of the simulation of the model that contains this MATLAB S-function
Required	No
Languages	MATLAB
Syntax	<code>SimStatusChange(s, status)</code>
Arguments	<p><code>s</code> Instance of <code>Simulink.MSFcnRunTimeBlock</code> class representing the Level-2 MATLAB S-Function block.</p> <p><code>status</code> Status of the simulation, either 0 when paused or 1 when continued.</p>
Description	The Simulink engine calls this routine when a simulation of the model containing S pauses or resumes. This method is only valid for simulation.
See Also	<code>Simulink.MSFcnRunTimeBlock</code> , <code>mdlSimStatusChange</code>

Purpose	Initialize the state vectors of this MATLAB S-function
Required	No
Language	MATLAB
Syntax	<code>Start(s)</code>
Arguments	<code>s</code> Instance of <code>Simulink.MSFcnRuntimeBlock</code> class representing the Level-2 MATLAB S-Function block.
Description	<p>The Simulink engine invokes this optional method at the beginning of a simulation. The method performs initialization activities that this S-function requires only once, such as allocating memory, setting up user data, or initializing states.</p> <p>If your S-function resides in an enabled subsystem and needs to reinitialize its states every whenever the subsystem is enabled, use <code>InitializeConditions</code> to initialize the state values, instead of <code>Start</code>.</p> <p>Use the properties of <code>Simulink.RuntimeBlock</code> to get the states.</p>
Example	See <code>msfcn_varpulse.m</code> for an example of how to use this function.
See Also	<code>InitializeConditions</code> , <code>Simulink.RuntimeBlock</code> , <code>mdlStart</code>

Terminate

Purpose	Perform any actions required at termination of the simulation
Required	Yes
Language	MATLAB
Syntax	Terminate(s)
Arguments	s Instance of Simulink.MSFcnRunTimeBlock class representing the Level-2 MATLAB S-Function block.
Description	This method performs any actions, such as freeing of memory, that must be performed when the simulation is terminated or when an S-Function block is destroyed (e.g., when it is deleted from a model).
See Also	mdlTerminate

Purpose	Update a block's states
Required	No
Language	MATLAB
Syntax	Update(s)
Arguments	s Instance of <code>Simulink.MSFcnRunTimeBlock</code> class representing the Level-2 MATLAB S-Function block.
Description	<p>The Simulink engine invokes this optional method at each major simulation time step. The method should compute the S-function's states at the current time step and store the states in the S-function's state vector. The method can also perform any other tasks that the S-function needs to perform at each major time step.</p> <p>Use this code if your S-function has one or more discrete states or does <i>not</i> have direct feedthrough.</p> <p>The reason for this is that most S-functions that do not have discrete states but do have direct feedthrough do not have update functions. Therefore, the engine is able to eliminate the need for the extra call in these circumstances.</p> <p>In Level-2 MATLAB S-functions, use the run-time object method <code>IsSampleHit</code> to determine if the current simulation time is one at which a task handled by this block is active. For port-based sample times, use the <code>IsSampleHit</code> property of the run-time object's <code>InputPort</code> or <code>OutputPort</code> to determine if the port produces outputs or accepts inputs at the current simulation time step.</p>
Example	For an example that uses this function to update discrete states, see <code>msfcn_unit_delay.m</code> .

Update

See Also

Derivatives, Simulink.RunTimeBlock,
Simulink.MSFcnRunTimeBlock, mdlUpdate

Purpose	Generate code generation data for the MATLAB S-function
Required	No
Language	MATLAB
Syntax	WriteRTW(s)
Arguments	s Instance of Simulink.MSFcnRunTimeBlock class representing the Level-2 MATLAB S-Function block.
Description	<p>This function is called when the Simulink Coder product is generating the <i>model.rtw</i> file.</p> <p>In Level-2 MATLAB S-functions, use the run-time object's WriteRTWParam method to write custom parameters to the <i>model.rtw</i> file.</p>
Example	See the S-function <i>adapt_lms.m</i> in the Simulink model <i>sldemo_msfcn_lms</i> for an example.
See Also	Simulink.MSFcnRunTimeBlock, mdlRTW

S-Function SimStruct Functions Reference

- “S-Function SimStruct Functions” on page 10-2
- “SimStruct Macros and Functions Listed by Usage” on page 10-3

S-Function SimStruct Functions

In this section...
“About SimStruct Functions” on page 10-2
“Language Support” on page 10-2
“The SimStruct” on page 10-2

About SimStruct Functions

The Simulink software provides a set of functions for accessing the fields of an S-function’s simulation data structure (`SimStruct`). S-function callback methods use these functions to store and retrieve information about an S-function.

Language Support

Some `SimStruct` functions are available only in some of the languages supported by the Simulink software. The reference page for each `SimStruct` macro or function lists the languages in which it is available and gives the syntax for these languages.

Note Most `SimStruct` functions available in C are implemented as C macros. Individual reference pages indicate any `SimStruct` macro that becomes a function when you compile your S-function in debug mode (`mex -g`).

The SimStruct

The file `simstruc.h` is a C language header file that defines the Simulink data structure and the `SimStruct` access macros. It encapsulates all the data relating to the model or S-function, including block parameters and outputs.

There is one `SimStruct` data structure allocated for the Simulink model. Each S-function in the model has its own `SimStruct` associated with it. The organization of these `SimStructs` is much like a directory tree. The `SimStruct` associated with the model is the *root* `SimStruct`. The `SimStructs` associated with the S-functions are the *child* `SimStructs`.

SimStruct Macros and Functions Listed by Usage

In this section...
“Buses” on page 10-3
“Data Type” on page 10-4
“Dialog Box Parameters” on page 10-5
“Error Handling and Status” on page 10-6
“Function Call” on page 10-6
“Input and Output Ports” on page 10-7
“Model Reference” on page 10-14
“Run-Time Parameters” on page 10-15
“Sample Time” on page 10-16
“Simulation Information” on page 10-17
“State and Work Vector” on page 10-20
“Code Generation” on page 10-23
“Miscellaneous” on page 10-25

Buses

Macro	Description
ssGetBusElementComplexSignal	Get the signal complexity for a bus element.
ssGetBusElementDataType	Get the data type identifier for a bus element.
ssGetBusElementDimensions	Get the dimensions of a bus element.
ssGetBusElementName	Get the name of a bus element.
ssGetBusElementNumDimensions	Get the number of dimensions for a bus element.

Macro	Description
ssGetBusElementOffset	Get the offset from the start of the bus data type to a bus element.
ssGetNumBusElements	Get the number of elements in a bus signal.
ssGetSFcnParamName	Get the value of a block parameter for an S-function block.
ssIsDataTypeABus	Determine whether a data type identifier represents a bus signal.
ssRegisterTypeFromParameter	Register a data type that a parameter in the Simulink data type table specifies.
ssSetBusInputAsStruct	Specify whether to convert the input bus signal for an S-function from virtual to nonvirtual.
ssSetBusOutputAsStruct	Specify whether the output bus signal from an S-function must be virtual or nonvirtual.
ssSetBusOutputObjectName	Specify the name of the bus object that defines the structure and type of the output bus signal.

Data Type

Macro	Description
ssGetDataTypeId	Get the ID for a data type.
ssGetDataTypeIdAliasedThruTo	Get the ID for the built-in data type associated with a data type alias.
ssGetDataTypeName	Get a data type's name.
ssGetDataTypeSize	Get a data type's size.
ssGetDataTypeZero	Get the zero representation of a data type.

Macro	Description
ssGetInputPortDataType	Get the data type of an input port.
ssGetNumDataTypes	Get the number of data types defined by an S-function or the model.
ssGetOutputPortDataType	Get the data type of an output port.
ssGetOutputPortSignal	Get an output signal of any type except double.
ssRegisterDataType	Register a data type.
ssSetDataTypeSize	Specify the size of a data type.
ssSetDataTypeZero	Specify the zero representation of a data type.
ssSetInputPortDataType	Specify the data type of signals accepted by an input port.
ssSetOutputPortDataType	Specify the data type of an output port.

Dialog Box Parameters

Macro	Description
ssGetDTypeIdFromMxArray	Get the Simulink data type of a dialog parameter.
ssGetNumSFcnParams	Get the number of parameters that an S-function expects.
ssGetSFcnParam	Get a parameter entered by a user in the S-Function block dialog box.
ssGetSFcnParamsCount	Get the actual number of parameters specified by the user.
ssSetNumSFcnParams	Set the number of parameters that an S-function expects.
ssSetSFcnParamTunable	Specify the tunability of a dialog box parameter.

Error Handling and Status

Macro	Description
ssGetErrorStatus	Get a string that identifies the last error.
ssPrintf	Print a variable-content msg.
ssSetErrorStatus	Report errors.
ssWarning	Display a warning message.

Function Call

Macro	Description
ssCallSystemWithTid	Execute a function-call subsystem connected to an S-function.
ssDisableSystemWithTid	Disable a function-call subsystem connected to this S-function block.
ssEnableSystemWithTid	Enable a function-call subsystem connected to this S-function.
ssGetCallSystemNumFcnCall-Destinations	Get the number of function-call destinations.
ssGetExplicitFCSSCtrl	Determine whether this S-function explicitly enables and disables the function-call subsystem that it invokes.
ssSetCallSystemOutput	Specify that an output port element issues a function call.
ssSetExplicitFCSSCtrl	Specify whether an S-function explicitly enables and disables the function-call subsystem that it calls.

Input and Output Ports

I/O Port – Signal Specification

Macro	Description
ssAllowSignalsWithMoreThan2D	Enable S-function to work with multidimensional input and output signals.
ssGetInputPortComplexSignal	Get the numeric type (complex or real) of an input port.
ssGetInputPortDataType	Get the data type of an input port.
ssGetInputPortDirectFeedThrough	Determine whether an input port has direct feedthrough.
ssGetInputPortFrameData	Determine whether a port accepts signal frames.
ssGetInputPortOffsetTime	Determine the offset time of an input port.
ssGetInputPortRequiredContiguous	Determine whether the signal elements entering a port must be contiguous.
ssGetInputPortSampleTime	Determine the sample time of an input port.
ssGetInputPortSampleTimeIndex	Get the sample time index of an input port.
ssGetOutputPortComplexSignal	Get the numeric type (complex or real) of an output port.
ssGetOutputPortDataType	Get the data type of an output port.
ssGetOutputPortFrameData	Determine whether a port outputs signal frames.
ssGetOutputPortOffsetTime	Determine the offset time of an output port.

I/O Port – Signal Specification (Continued)

Macro	Description
ssGetOutputPortSampleTime	Determine the sample time of an output port.
ssSetInputPortComplexSignal	Set the numeric type (real or complex) of an input port.
ssSetInputPortDataType	Set the data type of an input port.
ssSetInputPortDirectFeedThrough	Specify that an input port is a direct-feedthrough port.
ssSetInputPortFrameData	Specify whether a port accepts signal frames.
ssSetInputPortOffsetTime	Specify the sample time offset for an input port.
ssSetInputPortRequiredContiguous	Specify that the signal elements entering a port must be contiguous.
ssSetInputPortSampleTime	Set the sample time of an input port.
ssSetNumInputPorts	Set the number of input ports on an S-Function block.
ssSetNumOutputPorts	Specify the number of output ports on an S-Function block.
ssSetOneBasedIndexInputPort	Specify that an input port expects one-based indices.
ssSetOneBasedIndexOutputPort	Specify that an output port emits one-based indices.
ssSetOutputPortComplexSignal	Specify the numeric type (real or complex) of this port.
ssSetOutputPortDataType	Specify the data type of an output port.

I/O Port – Signal Specification (Continued)

Macro	Description
ssSetOutputPortFrameData	Specify whether a port outputs framed data.
ssSetOutputPortOffsetTime	Specify the sample time offset value of an output port.
ssSetOutputPortSampleTime	Specify the sample time of an output port.
ssSetZeroBasedIndexInputPort	Specify that an input port expects zero-based indices.
ssSetZeroBasedIndexOutputPort	Specify that an output port emits zero-based indices.

I/O Port – Signal Dimensions

Macro	Description
	Register a method to handle current dimensions update.
	Register a method to check the current input dimensions.
ssAllowSignalsWithMoreThan2D	Enable S-function to work with multidimensional signals.
	Gets the current size of dimension dIdx of input port pIdx.
	Gets the total width (total number of elements) of the signal at input port pIdx
	Gets the current size of dimension dIdx of the signal at output port pIdx.

I/O Port – Signal Dimensions (Continued)

Macro	Description
	Gets the total width (total number of elements) of the signal at output port pIdx.
ssGetInputPortDimensions	Get the dimensions of the signal accepted by an input port.
ssGetInputPortDimensionSize	Get the size of one dimension of the signal entering an input port.
	Gets the dimensions mode of the input port indexed by pIdx,
ssGetInputPortNumDimensions	Get the dimensionality of the signals accepted by an input port.
ssGetInputPortWidth	Determine the width of an input port.
ssGetOutputPortDimensions	Get the dimensions of the signal leaving an output port.
ssGetOutputPortDimensionSize	Get the size of one dimension of the signal leaving an output port.
	Sets the dimensions mode of the output port indexed by pIdx.
ssGetOutputPortNumDimensions	Get the number of dimensions of an output port.
ssGetOutputPortWidth	Determine the width of an output port.
	Sets the current size corresponding to dimension dIdx of the output signal at port pIdx.

I/O Port – Signal Dimensions (Continued)

Macro	Description
	Set the block flag for resetting the dIndex DWork size upon subsystem reset.
ssSetInputPortDimensionInfo	Set the dimensionality of an input port.
	Sets the dimensions mode of the input port indexed by pIdx.
	Set the dimensions of output port outIdx to be equal than the
ssSetInputPortMatrixDimensions	Specify dimension information for an input port that accepts matrix signals.
ssSetInputPortVectorDimension	Specify dimension information for an input port that accepts vector signals.
ssSetInputPortWidth	Set the width of a 1-D (vector) input port.
ssSetOutputPortDimensionInfo	Specify the dimensionality of an output port.
ssSetOutputPortMatrixDimensions	Specify dimension information for an output port that emits matrix signals.
ssSetOutputPortVectorDimension	Specify dimension information for an output port that emits vector signals.
ssSetOutputPortWidth	Specify the width of a 1-D (vector) output port.

I/O Port – Signal Dimensions (Continued)

Macro	Description
ssSetOutputPortMatrixDimensions	Specify the dimensions of a 2-D (matrix) signal.
	Register the method to handle dimensions mode propagation for each input port.
	Set the type of output dependency on the input signal.
ssSetVectorMode	Specify the vector mode that an S-function supports.

I/O Port – Signal Access

Macro	Description
ssGetInputPortBufferDstPort	Determine the output port that is overwriting an input port's memory buffer.
ssGetInputPortConnected	Determine whether an S-Function block port is connected to a nonvirtual block.
ssGetInputPortOptimOpts	Determine the reusability setting of the memory allocated to the input port of an S-function.
ssGetInputPortOverWritable	Determine whether an input port can be overwritten.
ssGetInputPortRealSignal	Get the address of a real, contiguous signal entering an input port.
ssGetInputPortRealSignalPtrs	Access the signal elements connected to an input port.

I/O Port – Signal Access (Continued)

Macro	Description
<code>ssGetInputPortSignal</code>	Get the address of a contiguous signal entering an input port.
<code>ssGetInputPortSignalPtrs</code>	Get pointers to input signal elements of type other than double.
<code>ssGetNumInputPorts</code>	Can be used in any routine (except <code>mdlInitializeSizes</code>) to determine how many input ports a block has.
<code>ssGetNumOutputPorts</code>	Can be used in any routine (except <code>mdlInitializeSizes</code>) to determine how many output ports a block has.
<code>ssGetOutputPortConnected</code>	Determine whether an output port is connected to a nonvirtual block.
<code>ssGetOutputPortBeingMerged</code>	Determine whether the output of this block is connected to a Merge block.
<code>ssGetOutputPortOptimOpts</code>	Determine the reusability of the memory allocated to the output port of an S-function.
<code>ssGetOutputPortRealSignal</code>	Access the elements of a signal connected to an output port.
<code>ssGetOutputPortSignal</code>	Get the vector of signal elements emitted by an output port.
<code>ssSetInputPortOptimOpts</code>	Specify the reusability of the memory allocated to the input port of an S-function.
<code>ssSetInputPortOverWritable</code>	Specify whether an input port is overwritable by an output port.

I/O Port – Signal Access (Continued)

Macro	Description
ssSetOutputPortOptimOpts	Specify the reusability of the memory allocated to the output port of an S-function.
ssSetOutputPortOverwritesInputPort	Specify whether an output port can share its memory buffer with an input port.

Model Reference

Macro	Description
ssRTWGenIsModelReferenceRTW-Target	Determine if the model reference Simulink Coder target is generating.
ssRTWGenIsModelReferenceSIM-Target	Determine if the model reference simulation target is generating.
ssSetModelReferenceNormalMode-Support	Specify if S-function can be used in referenced model simulating in normal mode.
ssSetModelReferenceSampleTime-DefaultInheritance	Specify that a submodel containing this S-function can inherit its sample time from its parent model.
ssSetModelReferenceSampleTime-DisallowInheritance	Specify that the use of this S-function in a submodel prevents the submodel from inheriting its sample time from its parent model.
ssSetModelReferenceSampleTime-InheritanceRule	Specify whether use of an S-function in a submodel prevents the submodel from inheriting its sample time from the parent model.

Run-Time Parameters

These macros allow you to create, update, and access run-time parameters corresponding to a block's dialog parameters.

Macro	Description
ssGetNumRunTimeParams	Get the number of run-time parameters created by this S-function.
ssGetRunTimeParamInfo	Get the attributes of a specified run-time parameter.
	Register all tunable dialog parameters as run-time parameters.
ssRegDlgParamAsRunTimeParam	Register a run-time parameter.
ssSetNumRunTimeParams	Specify the number of run-time parameters to be created by this S-function.
ssSetRunTimeParamInfo	Specify the attributes of a specified run-time parameter.
	Update all run-time parameters corresponding to tunable dialog parameters.
ssUpdateDlgParamAsRunTimeParam	Update a run-time parameter.
ssUpdateRunTimeParamData	Update the value of a specified run-time parameter.
ssUpdateRunTimeParamInfo	Update the attributes of a specified run-time parameter from the attributes of the corresponding dialog parameters.

Sample Time

Macro	Description
<code>ssGetInputPortSampleTime</code>	Determine the sample time of an input port.
<code>ssGetInputPortSampleTimeIndex</code>	Get the sample time index of an input port.
<code>ssGetNumSampleTimes</code>	Get the number of sample times an S-function has.
<code>ssGetOffsetTime</code>	Determine one of an S-function's sample time offsets.
<code>ssGetOutputPortSampleTime</code>	Determine the sample time of an output port.
<code>ssGetPortBasedSampleTimeBlock-IsTriggered</code>	Determine whether a block that uses port-based sample times resides in a triggered subsystem.
<code>ssGetSampleTime</code>	Determine one of an S-function's sample times.
<code>ssGetTNext</code>	Get the time of the next sample hit in a discrete S-function with a variable sample time.
<code>ssIsContinuousTask</code>	Determine whether a specified rate is the continuous rate.
<code>ssIsSampleHit</code>	Determine the sample rate at which an S-function is operating.
<code>ssIsSpecialSampleHit</code>	Determine whether the current sample time hits two specified rates.
<code>ssSampleAndOffsetAreTriggered</code>	Determine whether a sample time and offset value pair indicate a triggered sample time.
<code>ssSetInputPortSampleTime</code>	Set the sample time of an input port.

Macro	Description
ssSetModelReferenceSampleTime-DefaultInheritance	Specify that a submodel containing this S-function can inherit its sample time from its parent model.
ssSetModelReferenceSampleTime-DisallowInheritance	Specify that the use of this S-function in a submodel prevents the submodel from inheriting its sample time from its parent model.
ssSetModelReferenceSampleTime-InheritanceRule	Specify whether use of an S-function in a submodel prevents the submodel from inheriting its sample time from the parent model.
ssSetNumSampleTimes	Set the number of sample times an S-function has.
ssSetOffsetTime	Specify the offset of a sample time.
ssSetSampleTime	Specify a sample time for an S-function.
ssSetTNext	Specify the time of the next sample hit in an S-function.

Simulation Information

Macro	Description
ssGetBlockReduction	Determine whether a block has requested block reduction before the simulation has begun and whether it has actually been reduced after the simulation loop has begun.
ssGetErrorStatus	Get a string that identifies the last error.
ssGetFixedStepSize	Get the fixed step size of the model containing the S-function.

Macro	Description
ssGetInlineParameters	Determine whether the user has set the inline parameters option for the model containing this S-function.
ssGetSimMode	Determine the context in which an S-function is being invoked: normal simulation, external-mode simulation, model editor, etc.
ssGetSimStatus	Determine the current simulation status.
ssGetSolverMode	Get the solver mode being used to solve the S-function.
ssGetSolverName	Get the name of the solver being used for the simulation.
ssGetStateAbsTol	Get the absolute tolerance used by the model's variable-step solver for a specified state.
ssGetStopRequested	Get the value of the simulation stop requested flag.
ssGetT	Get the current base simulation time.
ssGetTaskTime	Get the current time for a task.
ssGetTFinal	Get the end time of the current simulation.
ssGetTNext	Get the time of the next sample hit.
ssGetTStart	Get the start time of the current simulation.
ssIsExternalSim	Determine if the model is running in external mode.
ssIsFirstInitCond	Determine whether the current simulation time is equal to the simulation start time.

Macro	Description
<code>ssIsMajorTimeStep</code>	Determine whether the current time step is a major time step.
<code>ssIsMinorTimeStep</code>	Determine whether the current time step is a minor time step.
<code>ssIsVariableStepSolver</code>	Determine whether the current solver is a variable-step solver.
<code>ssRTWGenIsAccelerator</code>	Determine if the model is running in Accelerator mode.
<code>ssSetStateAbsTol</code>	Set the values of the absolute tolerances that the variable-step solver will apply to the S-function states.
<code>ssSetBlockReduction</code>	Request that Simulink attempt to reduce a block.
<code>ssSetSimStateCompliance</code>	Specify how Simulink treats an S-function when saving and restoring the simulation state of a model containing the S-function.
<code>ssSetSimStateVisibility</code>	Specify whether or not the simulation state of the S-function is visible (accessible) in the simulation state of the model.
<code>ssSetSolverNeedsReset</code>	Ask Simulink to reset the solver.
<code>ssSetStopRequested</code>	Ask Simulink to terminate the simulation at the end of the current time step.

State and Work Vector

Macro	Description
<code>ssGetContStates</code>	Get an S-function's continuous states.
<code>ssGetDiscStates</code>	Get an S-function's discrete states.
<code>ssGetDWork</code>	Get a DWork vector.
<code>ssGetDWorkComplexSignal</code>	Determine whether the elements of a DWork vector are real or complex numbers.
<code>ssGetDWorkDataType</code>	Get the data type of a DWork vector.
<code>ssGetDWorkName</code>	Get the name of a DWork vector.
<code>ssGetDWorkUsageType</code>	Determine how the DWork vector is used in S-function.
<code>ssGetDWorkUsedAsDState</code>	Determine whether a DWork vector is used as a discrete state vector.
<code>ssGetDWorkWidth</code>	Get the size of a DWork vector.
<code>ssGetdX</code>	Get the derivatives of the continuous states of an S-function.
<code>ssGetIWork</code>	Get an S-function's integer-valued (<code>int_T</code>) work vector.
<code>ssGetIWorkValue</code>	Get a value from a block's integer work vector.
<code>ssGetModeVector</code>	Get an S-function's mode work vector.
<code>ssGetModeVectorValue</code>	Get an element of a block's mode vector.
<code>ssGetNonsampledZCs</code>	Get an S-function's zero-crossing signals vector.
<code>ssGetNumContStates</code>	Determine the number of continuous states that an S-function has.

Macro	Description
<code>ssGetNumDiscStates</code>	Determine the number of discrete states that an S-function has.
<code>ssGetNumDWork</code>	Get the number of data type work vectors used by a block.
<code>ssGetNumIWork</code>	Get the size of an S-function's integer work vector.
<code>ssGetNumModes</code>	Determine the size of an S-function's mode vector.
<code>ssGetNumNonsampledZCs</code>	Determine the number of nonsampled zero crossings that an S-function detects.
<code>ssGetNumPWork</code>	Determine the size of an S-function's pointer work vector.
<code>ssGetNumRWork</code>	Determine the size of an S-function's real-valued (<code>real_T</code>) work vector.
<code>ssGetPWork</code>	Get an S-function's pointer (<code>void *</code>) work vector.
<code>ssGetPWorkValue</code>	Get a pointer from a pointer work vector.
<code>ssGetRealDiscStates</code>	Get the real (<code>real_T</code>) values of an S-function's discrete state vector.
<code>ssGetRWork</code>	Get an S-function's real-valued (<code>real_T</code>) work vector.
<code>ssGetRWorkValue</code>	Get an element of an S-function's real-valued work vector.
<code>ssSetDWorkComplexSignal</code>	Specify whether the elements of a data type work vector are real or complex.
<code>ssSetDWorkDataType</code>	Specify the data type of a data type work vector.

Macro	Description
<code>ssSetDWorkName</code>	Specify the name of a data type work vector.
<code>ssSetDWorkUsageType</code>	Specify how the DWork vector is used in S-function.
<code>ssSetDWorkUsedAsDState</code>	Specify that a data type work vector is used as a discrete state vector.
<code>ssSetDWorkWidth</code>	Specify the width of a data type work vector.
<code>ssSetIWorkValue</code>	Set an element of a block's integer work vector.
<code>ssSetModeVectorValue</code>	Set an element of a block's mode vector.
<code>ssSetNumContStates</code>	Specify the number of continuous states that an S-function has.
<code>ssSetNumDiscStates</code>	Specify the number of discrete states that an S-function has.
<code>ssSetNumDWork</code>	Specify the number of data type work vectors used by a block.
<code>ssSetNumIWork</code>	Specify the size of an S-function's integer (<code>int_T</code>) work vector.
<code>ssSetNumModes</code>	Specify the number of operating modes that an S-function has.
<code>ssSetNumNonsampledZCs</code>	Specify the number of zero crossings that an S-function detects.
<code>ssSetNumPWork</code>	Specify the size of an S-function's pointer (<code>void *</code>) work vector.
<code>ssSetNumRWork</code>	Specify the size of an S-function's real (<code>real_T</code>) work vector.

Macro	Description
<code>ssSetPWorkValue</code>	Set an element of a block's pointer work vector.
<code>ssSetRWorkValue</code>	Set an element of a block's floating-point work vector.

Code Generation

Macro	Description
<code>ssGetDWorkRTWIdentifier</code>	Get the identifier used to declare a DWork vector in code generated from the associated S-function.
<code>ssGetDWorkRTWIdentifierMustResolveToSignalObject</code>	Get a flag indicating if a DWork vector resolves to a <code>Simulink.Signal</code> object.
<code>ssGetDWorkRTWStorageClass</code>	Get the storage class of a DWork vector in code generated from the associated S-function.
<code>ssGetDWorkRTWTypeQualifier</code>	Get the C type qualifier (e.g., <code>const</code>) used to declare a DWork vector in code generated from the associated S-function.
<code>ssGetPlacementGroup</code>	Get the name of the placement group of a block.
<code>ssRTWGenIsCodeGen</code>	Identify any code generation that is not used by the Accelerator.
<code>ssSetDWorkRTWIdentifier</code>	Set the identifier used to declare a DWork vector in code generated from the associated S-function.
<code>ssSetDWorkRTWIdentifierMustResolveToSignalObject</code>	Specify if a DWork vector resolves to a <code>Simulink.Signal</code> object.

Macro	Description
<code>ssSetDWorkRTWStorageClass</code>	Set the storage class of a DWork vector in code generated from the associated S-function.
<code>ssSetDWorkRTWTypeQualifier</code>	Set the C type qualifier (e.g., <code>const</code>) used to declare a DWork vector in code generated from the associated S-function.
<code>ssSetPlacementGroup</code>	Specify the name of the placement group of a block.
<code>ssWriteRTW2dMatParam</code>	Write a Simulink matrix parameter to the S-function's <code>model.rtw</code> file.
<code>ssWriteRTWMx2dMatParam</code>	Write a MATLAB matrix parameter to the S-function's <code>model.rtw</code> file.
<code>ssWriteRTWMxVectParam</code>	Write a MATLAB vector parameter to the S-function's <code>model.rtw</code> file.
<code>ssWriteRTWParameters</code>	Write tunable parameters to the S-function's <code>model.rtw</code> file.
<code>ssWriteRTWParamSettings</code>	Write settings for the S-function's parameters to the <code>model.rtw</code> file.
<code>ssWriteRTWScalarParam</code>	Write a scalar parameter to the S-function's <code>model.rtw</code> file.
<code>ssWriteRTWStr</code>	Write a string to the S-function's <code>model.rtw</code> file.
<code>ssWriteRTWStrParam</code>	Write a string parameter to the S-function's <code>model.rtw</code> file.
<code>ssWriteRTWStrVectParam</code>	Write a string vector parameter to the S-function's <code>model.rtw</code> file.
<code>ssWriteRTWVectParam</code>	Write a Simulink vector parameter to the S-function's <code>model.rtw</code> file.
<code>ssWriteRTWWorkVect</code>	Write the S-function's work vectors to the <code>model.rtw</code> file.

Miscellaneous

Macro	Description
ssCallExternalModeFcn	Invoke the external mode function for an S-function.
ssGetModelName	Get the name of an S-Function block or model containing the S-function.
ssGetParentSS	Get the parent of an S-function.
ssGetPath	Get the path of an S-function or the model containing the S-function.
ssGetRootSS	Return the root (model) SimStruct.
ssGetUserData	Access user data.
ssSetExternalModeFcn	Specify the external mode function for an S-function.
ssSetOptions	Set various simulation options.
ssSetPlacementGroup	Specify the execution order of a sink or source S-function.
ssSetUserData	Specify user data.
ssSupportsMultipleExecInstances	Allow an S-function to operate within a For Each Subsystem.

S-Function Options — Alphabetical List

This section describes the S-function options available through `ssSetOptions`. Each S-function sets its applicable options at the end of its `mdlInitializeSizes` method. Use the OR operator (`|`) to set multiple options. For example:

```
ssSetOptions(S, SS_OPTION_EXCEPTION_FREE_CODE |  
              SS_OPTION_DISCRETE_VALUED_OUTPUT);
```

SS_OPTION_ALLOW_CONSTANT_PORT_SAMPLE_TIME

- Purpose** Allow constant sample time for a port
- Description** Allows an S-function with port-based sample times to specify or inherit constant sample times. Setting this option tells the Simulink engine that all input and output ports support constant sample times. See “Specifying Constant Sample Time for a Port” on page 8-39 for more information.
- Example** See `sfun_port_constant.c`, the source file for the `sfcndemo_port_constant` example, for an example.
- See Also** `SS_OPTION_DISALLOW_CONSTANT_SAMPLE_TIME`

SS_OPTION_ALLOW_INPUT_SCALAR_EXPANSION

Purpose

Allow scalar expansion of input ports

Description

Specifies that the input to your S-function input ports can be have a width of either 1 or the size specified by the port, usually referred to as the block width. The S-function expands scalar inputs to the same dimensions as the block width. See “Scalar Expansion of Inputs” on page 8-25 for more information.

Example

See `sfun_multiport.c`, the source file for the `sfcndemo_sfun_multiport` example, for an example.

SS_OPTION_ALLOW_PARTIAL_DIMENSIONS_CALL

Purpose Allow calls to `mdlSetInputPortDimensionInfo` and `mdlSetOutputPortDimensionInfo` with partial dimension information

Description Indicates the S-function can handle dynamically dimensioned signals. By default, the Simulink engine calls the `mdlSetInputPortDimensionInfo` or `mdlSetOutputPortDimensionInfo` methods if the number of dimensions and size of each dimension for the candidate port are fully known. If `SS_OPTION_ALLOW_PARTIAL_DIMENSIONS_CALLS` is set, the engine may also call these methods with partial dimension information. For example, the methods may be called when the port width is known, but the actual 2-D dimensions are unknown. See `mdlSetDefaultPortDimensionInfo` for more information.

See Also `mdlSetDefaultPortDimensionInfo`

SS_OPTION_ALLOW_PORT_SAMPLE_TIME_IN_TRIGSS

- Purpose** Allow an S-function with port-based sample times to operate in a triggered subsystem
- Description** Allows an S-function that uses port-based sample times to operate in a triggered subsystem. During sample time propagation, use the macro `ssSampleAndOffsetAreTriggered` to determine if the sample and offset times correspond to the block being in a triggered subsystem. If the block is triggered, all port sample times must be either triggered or constant. See “Configuring Port-Based Sample Times for Use in Triggered Subsystems” on page 8-41 for more information.
- Example** See `sfun_port_triggered.c`, the source file for the `sfcndemo_port_triggered` example, for an example.
- See Also** `ssSampleAndOffsetAreTriggered`

SS_OPTION_ASYNC_RATE_TRANSITION

Purpose

Create a read-write pair of blocks that ensure correct data transfer

Description

Creates a read-write pair of blocks intended to guarantee correct data transfers between a synchronously (periodic) and an asynchronously executing subsystem or between two asynchronously executing subsystems. Both the read S-function and write S-function should set this option.

An asynchronously executed function-call subsystem is a function-call subsystem driven by an S-function with the `SS_OPTION_ASYNCHRONOUS` specified.

The Simulink engine defines two classes of asynchronous rate transitions.

- Read-write pairs. In this class, two blocks, using a technique such as double buffering, ensure data integrity in a multitasking environment. When creating the read-write pair of blocks, the S-functions for these blocks should set the `SS_OPTION_ASYNC_RATE_TRANSITION` option. Furthermore, the `MaskType` property of the read block, must include the string `read` and the `MaskType` property of write block must include the string `write`.
- A single protected or unprotected block. To create a single Protected Rate Transition block, create a subsystem that contains the following

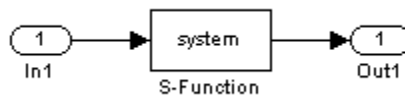

and set the `Tag` value of the Output block to `AsyncRateTransition`. The S-function then provides the code for the protected transition. Note, this S-function does not set the `SS_OPTION_ASYNC_RATE_TRANSITION` option.

See Also

`SS_OPTION_ASYNCHRONOUS`

Purpose

Specify this S-function drives a function-call subsystem attached to interrupt service routines

Description

Specifies that the S-function is driving function-call subsystems attached to interrupt service routines. This option applies only to S-functions that have no input ports during code generation and 1 output port. During simulation, the S-function may have an input port to provide a condition on which to execute. The output port must be configured to perform function calls on every element. If any of these requirements is not met, the `SS_OPTION_ASYNCHRONOUS` option is ignored. Specifying this option

- Informs the Simulink engine that there is no implied data dependency involving the data sources or destinations of the function-call subsystem called by the S-function.
- Causes the function-call subsystem attached to the S-function to be colored cyan, indicating that it does not execute at a periodic rate.
- Enables additional checks to verify that the model is constructed correctly.
 - 1** The engine validates that the appropriate asynchronous rate transition blocks reside between the cyan function-call subsystem. The engine also checks that period tasks exists. You can directly read and write from the function-call subsystem by using a block that has no computational overhead. To ensure safe task transitions between period and asynchronous tasks, use the `SS_OPTION_ASYNC_RATE_TRANSITION` option.
 - 2** For data transfers between two asynchronously executed (cyan) function-call subsystem, the engine validates that the appropriate asynchronous task transition blocks exists.

See Also

`SS_OPTION_ASYNC_RATE_TRANSITION`

SS_OPTION_CALL_TERMINATE_ON_EXIT

Purpose Force call to `mdlTerminate`

Description Guarantees the Simulink engine calls the S-function's `mdlTerminate` method before destroying a block that references the S-function. Calling `mdlTerminate` allows your S-function to clean up after itself, for example, by freeing memory it allocated during a simulation. The engine destroys an S-function block under the following circumstances.

- 1** A simulation ends either normally or as a result of invoking `ssSetErrorStatus`.
- 2** A user deletes the block.
- 3** The engine eliminates the block as part of a block reduction optimization (see “Block reduction”).

If this option is not set, the engine calls your S-function's `mdlTerminate` method only if the `mdlStart` method of at least one block in the model containing the S-function executed without error.

Example See the S-function `sfun_runtime3.c` for an example.

See Also `mdlTerminate`

SS_OPTION_CAN_BE_CALLED_CONDITIONALLY

Purpose	Specify this S-function can be called conditionally
Description	Specifies that the S-function can be called conditionally by other blocks. The Simulink engine uses this option to determine if the S-Function block can be moved into the execution context of the conditionally executed subsystem in which the S-function resides. See “Conditional Execution Behavior” in Using Simulink for more information.
Example	See the S-function <code>sdotproduct.c</code> used in the Simulink model <code>sfcn_demo_sdotproduct</code> for an example.

SS_OPTION_DISALLOW_CONSTANT_SAMPLE_TIME

Purpose Disallow constant sample time inheritance

Description Prohibits the S-Function block that references this S-function from inheriting a constant sample time. The `SS_OPTION_DISALLOW_CONSTANT_SAMPLE_TIME` option applies only to S-functions that use block-based sample times.

Note If you have Simulink Coder, and the S-function declares the number of sample times as `PORT_BASED_SAMPLE_TIMES`, it will not inherit a constant sample time unless it specifies the `SS_OPTION_ALLOW_CONSTANT_PORT_SAMPLE_TIME` option.

If you have Simulink Coder, note:

- If the S-function specifies this option and inherits a constant sample time, i.e., a sample time of `inf`, the Simulink Coder product determines how to generate code for the block based on if the block is invariant.
- A block is invariant if all of its ports' signals are invariant. A signal is invariant if it has a constant value during the entire simulation. A constant block sample time does not guarantee all the ports' signals are invariant. For more information, see "Inline Invariant Signals".
- If the block is not invariant, the Simulink Coder product generates code only in the `model_initialize` function. If the block is invariant, the Simulink Coder product eliminates the block's code altogether.

Example See `sfblk_manswitch.c` for an example.

See Also `SS_OPTION_ALLOW_CONSTANT_PORT_SAMPLE_TIME`

SS_OPTION_DISCRETE_VALUED_OUTPUT

Purpose

Specify this S-function has discrete valued output

Description

Specifies this S-function has discrete valued outputs. With this option set, the Simulink engine does not assign algebraic variables to this S-function when it appears in an algebraic loop.

SS_OPTION_EXCEPTION_FREE_CODE

- Purpose** Improve performance of exception-free S-functions
- Description** Improves performance of S-functions that do not use `mexErrMsgTxt`, `mxCalloc`, or any other routines that can throw an exception. An S-function is not exception free if it contains any routine that, when called, has the potential of long-jumping out of a block of code and into another scope. See “Exception Free Code” on page 8-70 for more information.
- Example** See `vsfunc.c` for an example.
- See Also** `SS_OPTION_RUNTIME_EXCEPTION_FREE_CODE`

Purpose

Specify generated code format for function-call subsystems called by this S-function

Description

If you have Simulink Coder, indicates that the software should generate procedures for all function-call subsystems called by this S-function, instead of possibly inlining the subsystem code. If an S-function sets this option, Simulink Coder ignores the **Inline** setting for the **Code generation function packaging** option in the Subsystem Parameters dialog box for the Subsystem block. For more information, see “About Nonvirtual Subsystem Code Generation”.

SS_OPTION_NONVOLATILE

Purpose	Enable the Simulink engine to remove unnecessary S-Function blocks
Description	Specifies this S-function has no side effects. Setting this option enables the Simulink engine to remove the S-Function block referencing this S-function during dead branch elimination, if it is not needed.
Example	See the S-function <code>sdotproduct.c</code> used in the Simulink model <code>sfcndemo_sdotproduct</code> for an example.

Purpose

Specify this S-function should be placed as soon as possible

Description

Specifies that this S-function should be placed as soon as possible in the block sorted order. The SS_OPTION_PLACE_ASAP option uses a hierarchical sorted order such as that used by blocks (“Rules for Block Priorities”). Within a subsystem, the Simulink engine places an S-function block using this option as far up in the sorted order as possible without changing the model’s semantics. If the S-function’s **Priority** block property is set, and other blocks in the same subsystem have the same priority, the engine places S-functions with this option before the other blocks in the same subsystem with the same priority. This option is typically used by devices connecting to hardware when you want to ensure the hardware connection is completed first.

Note Simulink honors the SS_OPTION_PLACE_ASAP option, relative to other blocks, only if this block and the other blocks are in the same subsystem. As a result, Simulink does not compare two blocks set with SS_OPTION_PLACE_ASAP if they exist in different subsystems. In addition, Simulink might not place blocks with SS_OPTION_PLACE_ASAP set before blocks without SS_OPTION_PLACE_ASAP set if they are in different subsystems.

For more information on block sorted orders, see “What Is Sorted Order?”.

SS_OPTION_PORT_SAMPLE_TIMES_ASSIGNED

Purpose Specify this S-function uses port-based sample times

Description Indicates the S-function registers multiple sample times (`ssSetNumSampleTimes > 1`) to specify the rate at which each input and output port is running. The simulation engine needs this information when checking for illegal rate transitions. If an S-function uses this option, it cannot inherit its sample times. See “Hybrid Block-Based and Port-Based Sample Times” on page 8-43 for more information.

Example See `mixedm.c` for an example.

SS_OPTION_REQ_INPUT_SAMPLE_TIME_MATCH

Purpose

Specify sample times of input signal and port must match

Description

Specifies that the input signal sample times must match the sample time assigned to the block input port. For example:



generates an error if this option is set. The Simulink engine does not generate an error if the block or input port sample time is inherited.

SS_OPTION_RUNTIME_EXCEPTION_FREE_CODE

- Purpose** Improve performance of run-time exception-free S-functions
- Description** Improves performance of S-functions that do not use mexErrMsgTxt, mxMalloc, or any other routines that can throw an exception inside of a run-time routines. Applicable run-time routines include mdlGetTimeOfNextVarHit, mdlOutputs, mdlUpdate, and mdlDerivatives.
- See Also** SS_OPTION_EXCEPTION_FREE_CODE

Purpose

Indicate S-Function block is a `SimViewingDevice`

Description

Indicates the S-Function block referencing this S-function is a `SimViewingDevice`. As long as the block meets the other requirements for a `SimViewingDevice`, i.e., no states, no outputs, etc., the Simulink engine considers the block to be an external mode block. As an external mode block, the block appears in the external mode user interface and the Simulink Coder product does not generate code for it. During an external mode simulation, the engine runs the block only on the host. See “Sim Viewing Devices in External Mode” on page 8-65 in *Writing S-Functions* for more information.

SS_OPTION_SFUNCTION_INLINED_FOR_RTW

Purpose Specify use of TLC file during code generation

Description Indicates the S-function has an associated TLC file and does not contain an mdlRTW method. Setting this option has no effect if the S-function contains an mdlRTW method. During code generation, if SS_OPTION_SFUNCTION_INLINED_FOR_RTW is set and the Simulink Coder product cannot locate the S-function's TLC file, the Simulink Coder product generates an error. If SS_OPTION_SFUNCTION_INLINED_FOR_RTW is not set but the Simulink Coder product does locate a TLC file for the S-function, it uses the TLC file.

Purpose

Support data type aliases

Description

Specifies how the S-function handles signals whose data types are aliases (see `Simulink.Aliastype` for more information about data type aliases). If this option is set and the S-function's inputs and outputs use data type aliases, SimStruct macros such as `ssGetInputPortDataType` and `ssGetOutputPortDataType` return the data type IDs of those aliases. However, if this option is not set, the SimStruct macros return the data type IDs associated with the equivalent built-in data types instead. For a list of built-in values for the data type ID, see `ssGetInputPortDataType`.

Note If you have Simulink Coder, and this option is not set and the S-function's inputs use data type aliases, the Simulink engine attempts to propagate the aliases to the S-function's outputs. However, this process can fail, in which case the engine propagates the equivalent built-in data types instead. To explicitly control the propagation of data type aliases through an S-function, enable the `SS_OPTION_SUPPORTS_ALIAS_DATA_TYPES` option.

SS_OPTION_USE_TLC_WITH_ACCELERATOR

Purpose Use TLC file when simulating in accelerated mode

Description Forces the Simulink Accelerator mode to use the Target Language Compiler (TLC) inlining code for the S-function, which speeds up execution of the S-function. If this option is not set, the Simulink Accelerator mode uses the MEX version of the S-function even if a TLC file for the S-function exists. This option should not be set for device driver blocks (A/D) or when there is an incompatibility between running the MEX `mdlStart` or `mdlInitializeConditions` functions together with the TLC `Outputs`, `Update`, or `Derivatives` functions. Also, this option indicates that the TLC inlining code should be used when generating a simulation target for a reference submodel that contains this S-function.

Note The Simulink Accelerator mode does not require the Simulink Coder product to run an inlined S-function. However, to ensure that the inlined S-function can run in accelerated mode in current and future Simulink releases, the TLC file for the S-function must use documented TLC functions to access the `CompiledModel` structure.

Example See the S-function `timestwo.c` used in the Simulink model `sfcn_demo_timestwo` for an example.

SS_OPTION_WORKS_WITH_CODE_REUSE

Purpose Specify this S-function supports code reuse

Description Signifies that this S-function is compatible with the Simulink Coder product subsystem code reuse feature. See “S-Functions That Support Code Reuse” in the "Simulink Coder User’s Guide" for more information. If this option is not set, the Simulink Coder product will not reuse any subsystem containing this S-Function.

Example See `timestwo.c` for an example.

SS_OPTION_WORKS_WITH_CODE_REUSE

A

- additional parameters for MATLAB
 - S-functions 3-18
- array bounds
 - checking 8-72

B

- block-based sample times 8-33
 - specifying 8-33
- Build Info pane
 - S-Function Builder 4-34

C

- C functions
 - integrating into Simulink models 4-55
 - example 4-58
- C language header file
 - `matlabroot/simulink/include/-
simstruc.h` 10-2
- C MEX S-functions 4-2
 - advantages 4-2
 - continuous state example 8-73
 - converting from Level 1 to Level 2 4-100
 - creating 4-3
 - definition 1-2
 - deploying S-functions generated with 4-74
 - discrete state example 8-80
 - example 4-43
 - feature list 2-8
 - generating and compiling with Legacy Code
Tool 4-71
 - hybrid system example 8-86
 - limitations 2-12
 - matrix support example 8-100
 - modes for compiling 4-53
 - S-Function Builder 4-5
 - Simulink engine interaction 4-76

- time-varying continuous transfer function
 - example 8-129
 - variable-step example 8-94
 - wrapper example 2-15
 - zero-crossing example 8-111

- C++ objects
 - making persistent 5-3
- C++ S-functions 5-1
 - building 5-5
 - mex command 5-5
- C-to-Fortran gateway S-function 6-8
- callback methods 1-13
- CFortran 6-13
- `cg_sfun.h` 4-52
- checking array bounds 8-72
- CheckParameters 9-2
- compile option
 - for legacy_code function 4-71
- compiler compatibility
 - Fortran 6-9
- continuous blocks
 - setting sample time 8-45
- Continuous Derivatives pane
 - S-Function Builder 4-30
- Converting Level-1 MATLAB S-functions 3-18
- creating persistent C++ objects 5-3

D

- data structures
 - Legacy Code Tool
 - for calling C++ functions 4-73
 - registering 4-61
 - registering multiple 4-73
- data types
 - supported by Legacy Code Tool 4-68
 - using user-defined 8-28
- device drivers
 - integrating into Simulink models 4-55
- direct feedthrough 1-20

- Discrete Update pane
 - S-Function Builder 4-32
- DWork Vectors
 - in C S-functions 7-7
 - overview 7-2
 - types of 7-5
- dynamically sized inputs 1-21

E

- error handling
 - checking array bounds 8-72
 - exception free code 8-69
- examples
 - C MEX S-function 4-43
 - continuous state S-function (C MEX) 8-73
 - discrete state S-function (C MEX) 8-80
 - Fortran MEX S-function 6-3
 - hybrid system S-function (C MEX) 8-86
 - integrating C functions into Simulink models 4-58
 - Legacy Code Tool 4-58 4-74
 - legacy_code function 4-58
 - matrix support S-function (C MEX) 8-100
 - pointer work vector 7-30
 - sample time for continuous block 8-45
 - sample time for hybrid block 8-45
 - time-varying continuous transfer function (C MEX) 8-129
 - variable-step S-function (C MEX) 8-94
 - zero-crossing S-function (C MEX) 8-111
- exception free code 8-70

F

- Fortran compilers 6-13
- Fortran math library 6-11
- Fortran MEX S-functions 6-3
 - example 6-3
 - template file 6-3

- frame-based signals, implementing in
 - S-functions 8-66
- function specifications
 - Legacy Code Tool
 - declaring 4-63
- function-call subsystems 8-59
- functions
 - Legacy Code Tool specifications for 4-63

H

- header files 4-51
- hybrid blocks
 - setting sample time 8-45
- hybrid sample times
 - specifying 8-43

I

- Initialization pane
 - S-Function Builder 4-16
- InitializeConditionsFcnSpec field
 - in Legacy Code Tool data structure 4-63
- input ports
 - how to create 8-18
- inputs, dynamically sized 1-21
- integration
 - of C functions into Simulink models 4-55
 - example 4-58

L

- Legacy Code Tool
 - data structures
 - for calling C++ functions 4-73
 - initialization 4-61
 - registering 4-61
 - registering multiple 4-73
 - declaring function specifications 4-63
 - deploying S-functions generated with 4-74
 - examples 4-74

- feature list 2-10
- generating and compiling S-functions
 - with 4-71
- integrating C functions into Simulink models
 - with 4-55
 - example 4-58
- limitations 4-75
- overview 4-55
- S-function limitations 2-12
- supported data types 4-68
- wrapper example 2-22
- legacy_code function
 - example 4-58
 - generating file for code generation
 - support 4-72
- Level 1 C MEX S-functions
 - converting to Level 2 4-100
- Libraries pane
 - S-Function Builder 4-24
- limitations
 - Legacy Code Tool 4-75
- lookup tables
 - integrating into Simulink models 4-55

M

- masked multiport S-functions 8-27
- masked S-function blocks
 - for calling S-function generated with Legacy Code Tool 4-72
- MATLAB S-functions
 - arguments 3-15
 - creating 3-14
 - creating run-time parameters 8-9
 - defining characteristics 3-17
 - feature list 2-8
 - Level-1 3-14
 - limitations 2-12
 - passing additional parameters 3-18
 - updating run-time parameters 8-15
 - using DWork vectors 7-12
 - using fixed-point data types 8-31
 - using sparse matrices 3-5
- matrix.h 4-51
- mdlCheckParameters 9-11
- mdlDerivatives 9-4 9-14
- mdlDisable 9-5 9-16
- mdlEnable 9-6 9-17
- mdlGetSimState 9-7 9-18
- mdlGetTimeOfNextVarHit 9-20
- mdlInitializeConditions 9-8 9-22
- mdlInitializeSampleTimes 9-26
- mdlInitializeSizes
 - calling sizes 3-17
- mdlInitializeSizes 9-31 9-119
- mdlOutputs 9-37 9-90
- mdlProcessParameters 9-39 9-93
- mdlProjection 9-41 9-94
- mdlRTW 9-48 9-127
- mdlSetDefaultPortComplexSignals 9-50
- mdlSetDefaultPortDataTypes 9-51
- mdlSetDefaultPortDimensionInfo 9-53
- mdlSetInputPortComplexSignal 9-55 9-100
- mdlSetInputPortDataType 9-57 9-102
- mdlSetInputPortDimensionInfo 9-59 9-104
- mdlSetInputPortDimensionsModeFcn 9-61 9-106
- mdlSetInputPortFrameData 9-62 9-107
- mdlSetInputPortSampleTime 9-64 9-108
- mdlSetInputPortWidth 9-67
- mdlSetOutputPortComplexSignal 9-68 9-110
- mdlSetOutputPortDataType 9-70 9-112
- mdlSetOutputPortDimensionInfo 9-72 9-114
- mdlSetOutputPortSampleTime 9-74 9-116
- mdlSetOutputPortWidth 9-76
- mdlSetSimState 9-77 9-118
- mdlSetWorkWidths 9-79 9-91
- mdlSimStatusChange 9-81 9-122
- mdlStart 9-82 9-123
- mdlTerminate 9-83 9-124

- mdlUpdate 9-86 9-125
- mdlZeroCrossings 9-88
- memory allocation 8-58
- memory and DWork vectors 7-2
- mex command
 - building C MEX S-functions 4-49
 - building C++ S-functions 5-5
- MEX S-functions
 - deploying S-functions generated with 4-74
 - generating and compiling with Legacy Code Tool 4-71
- mex.h 4-51
- multirate S-Function blocks 8-44
 - synchronizing 8-46
- mxArrays
 - in S-functions 8-57

O

- obsolete macros 4-103
- output ports
 - how to create 8-24
- OutputFcnSpec field
 - in Legacy Code Tool data structure 4-63
- Outputs pane
 - S-Function Builder 4-26

P

- parameters
 - MATLAB S-functions 3-18
 - passing to S-functions 1-5
 - run-time parameters 8-8
 - tunable parameters 8-5
- penddemo example 1-8
- persistence
 - C++ objects 5-3
- port-based sample times 8-37
 - constant 8-39
 - inherited 8-38

- specifying 8-37
- triggered 8-41

R

- reentrancy 7-2
- run-time parameters 8-8
- run-time routines 8-71

S

- S-function block I/O ports 8-18
- S-function blocks
 - masked
 - for S-functions generated with Legacy Code Tool 4-72
- S-Function blocks
 - multirate 8-44
 - S-functions parameters field 8-2
 - synchronizing multirate 8-46
- S-function Builder
 - wrapper example 2-17
- S-Function Builder
 - Build Info pane 4-34
 - Continuous Derivatives pane 4-30
 - customizing 4-12
 - Discrete Update pane 4-32
 - feature list 2-10
 - for C MEX S-functions 4-5
 - Initialization pane 4-16
 - Libraries pane 4-24
 - limitations 2-12
 - Outputs pane 4-26
 - setting the include path 4-25
- S-function data types 4-53
- S_FUNCTION_LEVEL 2, #define 4-50
- S_FUNCTION_NAME, #define 4-50
- S-functions
 - building C++ 5-5
 - C MEX 1-2

- choosing how to implement 2-3
 - comparison of different types 2-8
 - creating C MEX 4-3
 - creating Fortran 6-3
 - creating Level-2 with Fortran 6-8
 - creating persistent C++ objects 5-3
 - creating run-time parameters 8-9
 - definition 1-2
 - deploying 4-74
 - direct feedthrough 1-20
 - DWork vectors 7-2
 - elementary work vectors 7-26
 - examples
 - incorporating legacy c code 2-14
 - exception free code 8-70
 - generating and compiling with Legacy Code Tool 4-71
 - Level-1 and Level-2 6-2
 - Level-1 MATLAB 3-14
 - limitations of different types 2-12
 - masked multiport 8-27
 - purpose 1-7
 - routines 1-11
 - run-time parameters 8-8
 - run-time routines 8-71
 - simulation process 4-76
 - using in models 1-3
 - ways to implement 2-2
 - when to use 1-7
- S-functions parameters field
- S-Function block 8-2
- sample times
- block-based 8-33
 - continuous block example 8-45
 - function behavior 8-32
 - hybrid block example 8-45
 - port-based 8-37
 - specifying block-based 8-33
 - specifying hybrid 8-43
 - specifying port-based 8-37
 - scalar expansion of inputs 8-25
 - sfen_cmex_generate option
 - for legacy_code function 4-71
 - sfuntmpl.c template 4-50
 - sfuntmpl_fortran.F template 6-3
 - sfuntmpl.m template
 - MATLAB S-function 3-14
 - simsizes function
 - MATLAB S-function 3-17
 - simstruc.h C language header file 10-2
 - simstruc_types.h 4-51
 - SimStruct 4-53
 - SimStruct macros 10-3
 - simulation loop 1-10
 - simulation stages 1-10
 - simulink.c 4-52
 - sizes structure
 - fields
 - MATLAB S-function 3-17
 - slblock_generate option
 - for legacy_code function 4-72
 - sparse matrix
 - in Level-2 MATLAB S-functions 3-5
 - SS_OPTION_ALLOW_CONSTANT_PORT_SAMPLE_TIME 11-2
 - SS_OPTION_ALLOW_INPUT_SCALAR_EXPANSION 11-3
 - SS_OPTION_ALLOW_PARTIAL_DIMENSIONS_CALL 11-4
 - SS_OPTION_ALLOW_PORT_SAMPLE_TIME_IN_TRIGSS 11-5
 - SS_OPTION_ASYNC_RATE_TRANSITION 11-6
 - SS_OPTION_ASYNCHRONOUS 11-7
 - SS_OPTION_CALL_TERMINATE_ON_EXIT 11-8
 - SS_OPTION_CAN_BE_CALLED_CONDITIONALLY 11-9
 - SS_OPTION_DISALLOW_CONSTANT_SAMPLE_TIME 11-10
 - SS_OPTION_DISCRETE_VALUED_OUTPUT 11-11
 - SS_OPTION_EXCEPTION_FREE_CODE 11-12
 - SS_OPTION_FORCE_NONINLINED_FCNCALL 11-13
 - SS_OPTION_NONVOLATILE 11-14
 - SS_OPTION_PLACE_ASAP 11-15
 - SS_OPTION_PORT_SAMPLE_TIMES_ASSIGNED 11-16
 - SS_OPTION_REQ_INPUT_SAMPLE_TIME_MATCH 11-17
 - SS_OPTION_RUNTIME_EXCEPTION_FREE_CODE 11-18

SS_OPTION_SFUNCTION_INLINED_FOR_RTW 11-20
SS_OPTION_SIM_VIEWING_DEVICE 11-19
SS_OPTION_SUPPORTS_ALIAS_DATA_TYPES 11-21
SS_OPTION_USE_TLC_WITH_ACCELERATOR 11-22
SS_OPTION_WORKS_WITH_CODE_REUSE 11-23
ssGetModeVectorValue 10-20
StartFcnSpec field
 in Legacy Code Tool data structure 4-63
synchronizing multirate S-Function blocks 8-46

T

templates
 MATLAB S-function 3-14
TerminateFcnSpec field

 in Legacy Code Tool data structure 4-63
TLC block file
 generating for C MEX S-functions 4-72
tmwtypes.h 4-51
tunable parameters 8-5

W

writing S-functions in MATLAB 3-14

Z

zero-crossing
 S-functions 8-50