

Embedded Coder®

User's Guide

R2013a

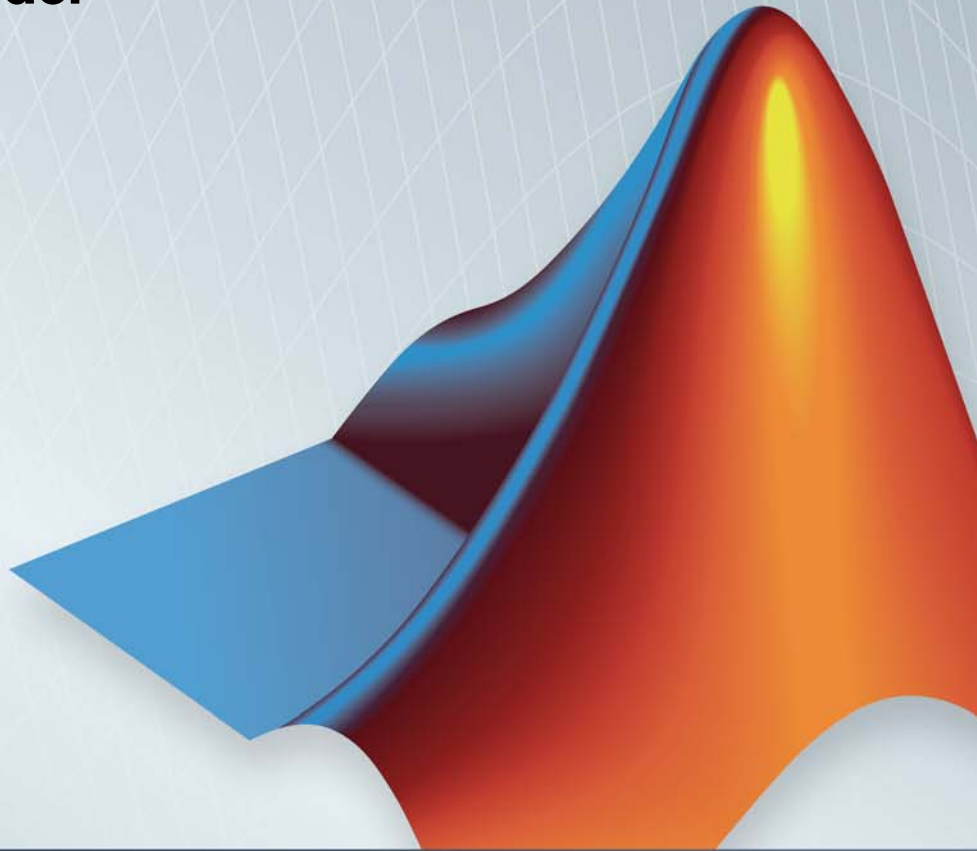

MATLAB® & SIMULINK®



How to Contact MathWorks



www.mathworks.com
comp.soft-sys.matlab
www.mathworks.com/contact_TS.html

Web
Newsgroup
Technical Support



suggest@mathworks.com
bugs@mathworks.com
doc@mathworks.com
service@mathworks.com
info@mathworks.com

Product enhancement suggestions
Bug reports
Documentation error reports
Order status, license renewals, passcodes
Sales, pricing, and general information



508-647-7000 (Phone)



508-647-7001 (Fax)



The MathWorks, Inc.
3 Apple Hill Drive
Natick, MA 01760-2098

For contact information about worldwide offices, see the MathWorks Web site.

Embedded Coder[®] User's Guide

© COPYRIGHT 2011–2013 by The MathWorks, Inc.

The software described in this document is furnished under a license agreement. The software may be used or copied only under the terms of the license agreement. No part of this manual may be photocopied or reproduced in any form without prior written consent from The MathWorks, Inc.

FEDERAL ACQUISITION: This provision applies to all acquisitions of the Program and Documentation by, for, or through the federal government of the United States. By accepting delivery of the Program or Documentation, the government hereby agrees that this software or documentation qualifies as commercial computer software or commercial computer software documentation as such terms are used or defined in FAR 12.212, DFARS Part 227.72, and DFARS 252.227-7014. Accordingly, the terms and conditions of this Agreement and only those rights specified in this Agreement, shall pertain to and govern the use, modification, reproduction, release, performance, display, and disclosure of the Program and Documentation by the federal government (or other entity acquiring for or through the federal government) and shall supersede any conflicting contractual terms or conditions. If this License fails to meet the government's needs or is inconsistent in any respect with federal procurement law, the government agrees to return the Program and Documentation, unused, to The MathWorks, Inc.

Trademarks

MATLAB and Simulink are registered trademarks of The MathWorks, Inc. See www.mathworks.com/trademarks for a list of additional trademarks. Other product or brand names may be trademarks or registered trademarks of their respective holders.

Patents

MathWorks products are protected by one or more U.S. patents. Please see www.mathworks.com/patents for more information.

Revision History

April 2011	Online only	New for Version 6.0 (Release 2011a)
September 2011	Online only	New for Version 6.1 (Release 2011b)
March 2012	Online only	New for Version 6.2 (Release 2012a)
September 2012	Online only	New for Version 6.3 (Release 2012b)
March 2013	Online only	New for Version 6.4 (Release 2013a)

Check Bug Reports for Issues and Fixes

Software is inherently complex and is not free of errors. The output of a code generator might contain bugs, some of which are not detected by a compiler. MathWorks reports critical known bugs brought to its attention on its Bug Report system at www.mathworks.com/support/bugreports/. Use the Saved Searches and Watched Bugs tool with the search phrase “Incorrect Code Generation” to obtain a report of known bugs that produce code that might compile and execute, but still produce wrong answers.

The bug reports are an integral part of the documentation for each release. Examine periodically all bug reports for a release, as such reports may identify inconsistencies between the actual behavior of a release you are using and the behavior described in this documentation.

In addition to reviewing bug reports, you should implement a verification and validation strategy to identify potential bugs in your design, code, and tools.

Bug Reports

1

Check Bug Reports for Issues and Fixes	1-2
--	-----

Model Architecture and Design

Modeling Environment

2

Set Up Your Modeling Environment	2-2
--	-----

Application Objectives

3

Guidelines and Standards

4

What Are the Standards and Guidelines?	4-2
MAAB Guidelines	4-4
MISRA C Guidelines	4-5
IEC 61508 Standard	4-7

Apply Simulink and Embedded Coder to the IEC 61508	
Standard	4-7
Check for IEC 61508 Standard Compliance Using the Model	
Advisor	4-7
Validate Traceability	4-8
ISO 26262 Standard	4-9
Apply Simulink and Embedded Coder to the ISO 26262	
Standard	4-9
Check for ISO 26262 Standard Compliance Using the Model	
Advisor	4-9
Validate Traceability	4-10
DO-178C Standard	4-11
Apply Simulink and Embedded Coder to the DO-178C	
Standard	4-11
Check for Standard Compliance Using the Model	
Advisor	4-11
Validate Traceability	4-12

Patterns for C Code

5

About Modeling Patterns	5-3
Prepare a Model for Code Generation	5-4
Configure a Signal	5-4
Configure Input and Output Ports	5-4
Initialize States	5-5
Set Up Configuration Parameters for Code Generation ...	5-5
Set Up an Example Model With a Stateflow Chart	5-6
Set Up an Example Model With a MATLAB Function	
Block	5-7
Data Declaration	5-9
C Construct	5-9
Declare a Variable for a Block Parameter Using a Data	
Object	5-9
C Construct	5-11

Declare a Variable for a Signal using a Data Object	5-11
Data Type Conversion	5-13
C Construct	5-13
Modeling Patterns	5-13
Modeling Pattern for Data Type Conversion — Simulink Block	5-13
Modeling Pattern for Data Type Conversion — Stateflow Chart	5-14
Modeling Pattern for Data Type Conversion — MATLAB Function Block	5-15
Other Type Conversions in Modeling	5-16
Type Qualifiers	5-17
Modeling Patterns for Type Qualifiers	5-17
Using a Tunable Parameter in the Base Workspace	5-17
Use a Data Object of the Const Custom Storage Class	5-18
Relational and Logical Operators	5-20
Modeling Patterns for Relational and Logical Operators	5-20
Modeling Pattern for Relational or Logical Operators — Simulink Blocks	5-20
Modeling Pattern for Relational and Logical Operators —Stateflow Chart	5-21
Modeling Pattern for Relational and Logical Operators — MATLAB Function Block	5-22
Bitwise Operations	5-24
Simulink Bitwise-Operator Block	5-24
Stateflow Chart	5-25
MATLAB Function Block	5-26
If-Else	5-28
C Construct	5-28
Modeling Patterns	5-28
Modeling Pattern for If-Else: Switch block	5-29
Modeling Pattern for If-Else: Stateflow Chart	5-31
Modeling Pattern for If-Else: MATLAB Function Block	5-33
Switch	5-35
C Construct	5-35

Modeling Patterns	5-35
Modeling Pattern for Switch: Switch Case block	5-36
Modeling Pattern for Switch: MATLAB Function block ...	5-39
Convert If-Elseif-Else to Switch statement	5-40
For Loop	5-41
C Construct	5-41
Modeling Patterns:	5-41
Modeling Pattern for For Loop: For-Iterator Subsystem block	5-42
Modeling Pattern for For Loop: Stateflow Chart	5-45
Modeling Pattern for For Loop: MATLAB Function block	5-48
While Loop	5-50
C Construct	5-50
Modeling Patterns	5-50
Modeling Pattern for While Loop: While Iterator Subsystem block	5-51
Modeling Pattern for While Loop: Stateflow Chart	5-55
Modeling Pattern for While Loop: MATLAB Function Block	5-58
Do While Loop	5-62
C Construct	5-62
Modeling Patterns	5-62
Modeling Pattern for Do While Loop: While Iterator Subsystem block	5-63
Modeling Pattern for Do While Loop: Stateflow Chart	5-66
Function Call	5-69
C Construct	5-69
Procedure	5-69
Results	5-70
Function Prototyping	5-71
C Construct	5-71
Modeling Patterns	5-71
Function Call Using Graphical Functions	5-71
Control Function Prototype of the <i>model_step</i> Function ..	5-73

External C Functions	5-75
C Construct	5-75
Modeling Patterns	5-75
Use the Legacy Code Tool to Create S-functions	5-75
Use a Stateflow Chart to Make Calls to C Functions	5-78
Using a MATLAB Function Block to Make Calls to C Functions	5-79
Macro Definitions (#define)	5-82
C Construct	5-82
Modeling Patterns	5-82
Use a 'Define' Custom Storage Class	5-82
Use a Custom Header File	5-83
Conditional Inclusions (#if / #endif)	5-85
Typedef	5-86
C Construct	5-86
Procedure	5-86
Results	5-87
Structures for Parameters	5-88
C Construct	5-88
Procedure	5-88
Results	5-89
Structures for Signals	5-91
C Construct	5-91
Modeling Patterns	5-91
Structure for Signals Using a 'Struct' Custom Storage Class	5-91
Structure for Signals Using a Simulink Non-Virtual Bus Object	5-93
Nested Structures	5-95
C Construct	5-95
Procedure	5-95
Results	5-97
Bitfields	5-99
C Construct	5-99

Procedure	5-99
Results	5-100
Arrays for Parameters	5-101
C Construct	5-101
Procedure	5-101
Results	5-102
Arrays for Signals	5-103
C Construct	5-103
Procedure	5-103
Results	5-104
Pointers for Signals	5-105
C Construct	5-105
Procedure	5-105
Results	5-105
Pointers Using Simulink Data Objects	5-106
C Construct	5-106
Procedure	5-106
Results	5-106

Variant Systems

6

About Variant Systems	6-2
Why Generate Code for Variant Systems?	6-3
Generate Preprocessor Conditionals for Variant Systems	6-4
Define Variant Controls	6-4
Configure Model for Generating Preprocessor Conditional Directives	6-6
Build Your Model	6-6

Review Code Variants in Code Generation Report	6-7
Generate Code for Model Variants	6-8
Generate Code for Variant Subsystems	6-10
Open the Example Model	6-10
Define the Variant Controls	6-10
Make Each Child Subsystem an Atomic Subsystem	6-11
Configure Model for Generating Preprocessor Conditional Directives	6-11
View the Generated Code	6-12
Restrictions on Variant Subsystem Code Generation ..	6-14
Special Considerations for Generating Preprocessor Conditionals	6-16
Limitations on Generating Code for Variants	6-17
Generated Code Components Not Compiled Conditionally	6-18

Scheduling Considerations

7

Use Discrete and Continuous Time	7-2
Support for Discrete and Continuous Time Blocks	7-2
Support for Continuous Solvers	7-2
Support for Stop Time	7-3
Optimize Multirate Multitasking Operation on RTOS	
Targets	7-4
Overview	7-4
Use rtmStepTask	7-5
Scheduling Code for Multirate Multitasking on VxWorks	7-5
Suppress Redundant Scheduling Calls	7-6

Data, Function, and File Definition

Data Types

8

Apply User-Defined Data Types	8-2
Define User Data Types	8-2
Select User-Defined Data Types	8-4
Specify Persistence Level for Signals and Parameters	8-7
Buses	8-11
About Buses and Code Generation	8-11
Set Bus Diagnostics	8-12
Optimize Virtual and Nonvirtual Buses	8-12
Use Single-Rate and Multi-Rate Buses	8-15
Set Bus Signal Initial Values	8-20
Use Buses with Atomic Subsystems	8-25
Rename Built-In Data Types	8-30
Generate Code Including User-Defined Data Types ...	8-32
About User-Defined Data Types	8-32
Specify Location of User-Defined Type Definitions	8-33
Apply User-Defined Data Types	8-34
Create Data Types for mpt Data Objects	8-35
Register mpt User Object Types	8-39
Data Type Replacement	8-44
Replace Data Types	8-44
Replace Built-In Data Type Names	8-46
Programmatically Replace Built-In Data Type Names ...	8-51
Replace <code>boolean</code> with an Integer Data Type	8-52
Data Type Replacement Limitations	8-54
Data Definition and Declaration Management	8-55
Overview of Data Dictionary	8-55
Create Simulink and mpt Data Objects	8-56
Create a Data Dictionary for a Model	8-70

Define Global Data Objects in Separate File	8-77
Define Global Data Objects in Separate Files	8-79
Save and Load Data Objects	8-79
Apply Naming Rules to Identifiers Globally	8-79

Module Packaging Tool (MPT) Data Objects

9

MPT Data Object Properties	9-2
----------------------------------	-----

Custom Storage Classes

10

Introduction to Custom Storage Classes	10-2
Custom Storage Class Memory Sections	10-3
Register Custom Storage Classes	10-3
Custom Storage Class Examples	10-4
Resources for Defining Custom Storage Classes	10-5
Simulink Package Custom Storage Classes	10-6
Design Custom Storage Classes and Memory	
Sections	10-8
Create Packages for Custom Storage Class Definitions ...	10-8
Use Custom Storage Class Designer	10-8
Edit Custom Storage Class Properties	10-16
Use Custom Storage Class References	10-23
Create and Edit Memory Section Definitions	10-28
Use Memory Section References	10-31
Apply Custom Storage Classes	10-34
About Applying Custom Storage Classes	10-34
Apply Custom Storage Classes to Parameters	10-35
Apply Custom Storage Classes to Signals	10-36

Custom Storage Classes Using Signal Objects	10-37
Custom Storage Classes Using Embedded Signal Objects	10-39
Specify Custom Storage Classes Using GUI	10-46
Specify Custom Storages Classes Using API	10-48
Generate Code with Custom Storage Classes	10-53
Code Generation Prerequisites	10-53
Code Generation With Custom Storage Classes	10-53
Define Advanced Custom Storage Classes Types	10-57
Introduction	10-57
Create Your Own Parameter and Signal Classes	10-57
Create Custom Attributes Classes for Custom Storage Classes	10-57
Write TLC Code for Custom Storage Classes	10-58
Register Custom Storage Class Definitions	10-58
GetSet Custom Storage Classes	10-61
About GetSet Custom Storage Class	10-61
GetSet Custom Storage Class Properties	10-61
Apply the GetSet Custom Storage	10-62
GetSet Custom Storage Class Restrictions	10-62
Increase Code Efficiency With GetSet CSC	10-63
Custom Storage Class Implementation	10-65
Custom Storage Class Limitations	10-67

User Package Registration

11

About Data Object Wizard and User Packages	11-2
Register User Packages Using <code>sl_customization.m</code>	11-3

User Package Customization Using	
sl_customization.m	11-5

Function and Class Interfaces

12

Function Prototype Control	12-2
About Function Prototype Control	12-2
Configure Function Prototypes Using Graphical	
Interfaces	12-3
Sample Procedure for Configuring Function Prototypes	12-11
Configure Function Prototypes Programmatically	12-16
Sample Script for Configuring Function Prototypes	12-20
Verify Generated Code for Customized Functions	12-21
Function Prototype Control Limitations	12-21
C++ Encapsulation Interface Control	12-24
About C++ Encapsulation Interface Control	12-24
Simple Use of C++ Encapsulation Control	12-25
Configure C++ Encapsulation Interfaces Using Graphical	
Interfaces	12-33
Configure C++ Encapsulation Interfaces	
Programmatically	12-43
Configure the Step Method for a Model Class	12-46
C++ Encapsulation Interface Control Limitations	12-47
Atomic Subsystem Code	12-49
About Nonvirtual Subsystem Code Generation	12-49
Configure Subsystem for Generating Modular Function	
Code	12-50
Modular Function Code for Nonvirtual Subsystems	12-55
Nonvirtual Subsystem Modular Function Code	
Limitations	12-60

About Memory Sections	13-2
What Are Memory Sections?	13-2
Requirements for Defining Memory Sections	13-3
Define Memory Sections	13-5
Edit Memory Section Properties	13-5
Specify the Memory Section Name	13-6
Specify a Qualifier for Custom Storage Class Data Definitions	13-7
Specify Comment and Pragma Text	13-7
Surround Individual Definitions with Pragmas	13-7
Include Identifier Names in Pragmas	13-8
Configure Memory Sections	13-9
Declare Constant Data as Volatile	13-10
Apply Memory Sections	13-13
Assign Memory Sections to Custom Storage Classes	13-13
Apply Memory Sections to Model-Level Functions and Internal Data	13-15
Apply Memory Sections to Atomic Subsystems	13-17
Generated Code with Memory Sections	13-21
Sample ERT-Based Model with Subsystem	13-21
Model-Level Data Structures	13-23
Model-Level Functions	13-23
Subsystem Function	13-24
Memory Section Limitation	13-26

Code Generation

Configuration

14

Application Objectives	14-2
High-Level Code Generation Objectives	14-3
Determine Model Configuration for Specified Objectives	14-5
Check and Configure Model for Code Generation Objectives	14-6
Check and Configure Model for Code Generation Objectives Using Configuration Parameters Dialog Box	14-10
Configure Code Generation Objectives Programmatically	14-13
Check Objectives in Referenced Models	14-14
Check Model During Code Generation	14-15
Create Custom Objectives	14-17
Specify Parameters in Custom Objectives	14-17
Specify Checks in Custom Objectives	14-18
Determine Checks and Parameters in Existing Objectives	14-19
How to Create Custom Objectives	14-20
Target	14-24
About Target Selection	14-24
Select an ERT Target	14-25
Customize an ERT Target	14-26
Configure Support for Numeric Data	14-26

Configure Support for Time Values	14-27
Support for Non-inlined S-Functions	14-27
Configure Model Function Generation and Argument Passing	14-28
Set Up Support for Code Reuse	14-29
Configure Code Replacement Libraries	14-31
Configuration Variations	14-32
About Model Configuration for Code Generation	14-32
Wizard	14-33
Block Library	14-33
Add a Configuration Wizard Block	14-35
Use Configuration Wizard Blocks	14-37
Create a Custom Configuration Wizard Block	14-37

Code Appearance

15

Add Custom Comments to Generated Code	15-2
Add Custom Comments for Signal or Parameter Identifiers	15-4
Add Global Comments	15-6
Use a Simulink DocBlock to Add a Comment	15-6
Use a Simulink Annotation to Add a Comment	15-9
Use a Stateflow Note to Add a Comment	15-9
Use Sorted Notes to Add Comments	15-10
Customize Generated Identifier Naming Rules	15-12
Identifier Format Control	15-14
Control Name Mangling in Generated Identifiers	15-18
Minimize Name Mangling	15-18

Avoid Identifier Name Collisions with Referenced Models	15-20
Maintain Traceability for Generated Identifiers	15-21
Exceptions to Identifier Formatting Conventions	15-22
Identifier Format Control Parameters Limitations ...	15-23
Specify Simulink Data Object Naming Rules	15-25
Control Code Style	15-26
Customize Code Organization and Format	15-28
Custom File Processing Overview	15-28
Custom File Processing Components	15-29
Custom File Processing User Interface Options	15-30
Code Generation Template (CGT) Files	15-31
Use Custom File Processing (CFP) Templates	15-35
Custom File Processing (CFP) Template Structure	15-36
Change the Organization of a Generated File	15-37
Generate Source and Header Files with a Custom File Processing (CFP) Template	15-39
Comparison of a Template and Its Generated File	15-48
Code Template API Summary	15-51
Generate Custom File and Function Banners	15-55
Template Symbols and Rules	15-63
Code Annotation for Justifying Polyspace Checks	15-72
Manage Placement of Data Definitions and Declarations	15-74
Overview of Data Placement	15-74
Priority and Usage	15-75
Ownership Settings	15-81
Memory Section Settings	15-81
Data Placement Rules	15-81
Settings for a Data Object	15-82
Data Placement Rules and Results	15-91

Specify Delimiter for #Includes	15-101
--	---------------

Source Code Generation

16

Generating Code Using Embedded Coder	16-2
Generate Code Modules	16-8
Introduction	16-8
Generated Code Modules	16-8
User-Written Code Modules	16-11
Customize Generated Code Modules	16-11
Generate Reentrant Code from MATLAB Code	16-14
What Is Reentrant Code?	16-14
When to Generate Reentrant Code	16-14
Generate Reentrant Code	16-15
Generated Code API	16-16
Call Reentrant Code in a Single-Thread Environment	16-16
Call Reentrant Code in a Multithreaded Environment ...	16-17
Call Reentrant Code with No Persistent or Global Data (UNIX Only)	16-18
Call Reentrant Code — Multithreaded with Persistent Data (Windows Only)	16-24
Call Reentrant Code — Multithreaded with Persistent Data (UNIX Only)	16-30

Code Generation for AUTOSAR Software Components

17

Overview of AUTOSAR Support	17-2
Simulink Modeling Patterns for AUTOSAR	17-3
About Simulink Modeling Patterns for AUTOSAR	17-3

AUTOSAR Software Components	17-3
AUTOSAR Communication	17-9
Calibration Parameters	17-15
Inter-Runnable Variables	17-16
Data Types	17-17
Per-Instance Memory	17-27
AUTOSAR Terminology	17-28
Workflows for AUTOSAR	17-31
Import an AUTOSAR Software Component	17-34
Create an AUTOSAR Software Component in Simulink	17-38
Prepare a Model for AUTOSAR Code Generation	17-43
Configure the AUTOSAR Interface	17-43
Configure Single Runnables for DataReceivedEvents	17-57
Configure Ports for Basic Software and Error Status Receivers	17-60
Configure Client-Server Communication	17-61
Configure Multiple Runnables	17-69
Configure Calibration Parameters	17-77
Use Data Store Memory Blocks to Specify Per-Instance Memory	17-79
Modify and Validate an Existing AUTOSAR Interface ...	17-80
Generate AUTOSAR Code and Description Files	17-82
Select an AUTOSAR Schema	17-82
Specify Maximum SHORT-NAME Length	17-83
Configure AUTOSAR Compiler Abstraction Macros	17-83
Root-Level Matrix I/O	17-85
Export AUTOSAR Software Component	17-85
Configure AUTOSAR Options Programmatically	17-88
Verify AUTOSAR Code with SIL and PIL	17-89
Overview	17-89
Use the SIL and PIL Simulation Modes	17-89
Use a SIL or PIL Block for AUTOSAR Verification	17-90

Limitations and Tips	17-92
Cannot Import Internal Behavior	17-92
Cannot Copy Subsystem Blocks Without Losing Interface Information	17-93
Source of Initial Output Value for Function-Call Subsystem Output	17-93
Error If No Default Configuration	17-93
The Generate Code Only Check Box	17-93
Specify Sample Time Independent Server Operation Model	17-93
Invoke AUTOSAR Server Operation Block in Referenced Model	17-94
Cannot Save Importer Objects in MAT-Files	17-94
Use the Merge Block for Inter-Runnable Variables	17-94
Use Goto and From Blocks Within Wrapper Subsystems ..	17-96
Postfix in Generated File Names	17-96
AUTOSAR Compiler Abstraction Macros	17-97
Intrinsic Fixed-Point Types for Model Configured as Server	17-98
Server Operation Model with Tunable Parameters	17-99
Relative File Paths in Code Descriptors	17-99
Sample Workflows and Further Reading	17-100
AUTOSAR Examples	17-100
Further Reading	17-100

Report Generation

18

HTML Code Generation Report Extensions	18-2
Traceability in Code Generation Report	18-4
Model Web View in Code Generation Report	18-6
About Model Web View	18-6
Generate HTML Code Generation Report with Model Web View	18-7
Model Web View Limitations	18-9

Analyze the Generated Code Interface	18-11
Code Interface Report Overview	18-11
Generating a Code Interface Report	18-12
Navigating Code Interface Report Subsections	18-15
Interpreting the Entry Point Functions Subsection	18-16
Interpreting the Inports and Outports Subsections	18-19
Interpreting the Interface Parameters Subsection	18-20
Interpreting the Data Stores Subsection	18-22
Code Interface Report Limitations	18-23
Static Code Metrics	18-25
About Static Code Metrics	18-25
Static Code Metrics Analysis	18-26
Generate a Static Code Metrics Report for a Simulink Model	18-28
Generate a Static Code Metrics Report for MATLAB Code	18-32
In a MATLAB Coder Project	18-32
At the Command Line	18-34
Analyze Code Replacements in the Generated Code ..	18-35
Generate HTML Report After Build Process	18-37

Deployment

Desktops

19

Shared Object Libraries	19-2
About Host-Based Shared Libraries	19-2
Generate Shared Library Version of Model Code	19-3
Create Application Code to Use Shared Library	19-3
Host-Based Shared Library Limitations	19-8

Real-Time and Embedded Systems

20

Standalone Programs (No Operating System)	20-2
About Standalone Program Execution	20-2
Generate a Standalone Program	20-2
Standalone Program Components	20-3
Main Program	20-3
rt_OneStep and Scheduling Considerations	20-5
Static Main Program Module	20-12
Rate Grouping Compliance and Compatibility Issues	20-16
Operating System Integration	20-22
Processor Support Packages	20-23

Import Custom Code into Model

21

Generate S-Function Wrappers	21-2
About S-Function Wrapper Generation	21-2
Create a SIL Block	21-3
S-Function Wrapper Generation Limitations	21-3

Export Code Generated from Model to External Application

22

Export Function-Call Subsystems	22-2
Exporting Function-Call Subsystems	22-2

Requirements for Exporting Function-Call Subsystems ..	22-3
Techniques for Exporting Function-Call Subsystems	22-6
Optimize Exported Function-Call Subsystems	22-8
Export Functions That Depend on Elapsed Time	22-8
Function-Call Subsystem Export	22-9
Function-Call Subsystems Export Limitations	22-12
Control Generation of Function Prototypes	22-14
C++ Encapsulation Interface Control	22-16

Code Replacement

23

Introduction to Code Replacement Libraries	23-2
Overview of Code Replacement Libraries	23-2
Code Replacement Libraries General Workflow	23-10
Code Replacement Libraries Quick-Start Example	23-11
Create Code Replacement Tables	23-18
Overview of Code Replacement Table Creation	23-18
Create Table Entries	23-22
Map Math Functions to Target-Specific Implementations	23-30
Map memcpy Function to Target-Specific Implementations	23-37
Map Nonfinite Utility Functions to Target-Specific Implementations	23-42
Map Scalar Operators to Target-Specific Implementations	23-47
Map Nonscalar Operators to Target-Specific Implementations	23-52
Map Fixed-Point Operators to Target-Specific Implementations	23-82
Remap Operator Outputs to Implementation Function Inputs	23-118
Configure Data Alignment for Function Implementations	23-120

Refine Matching and Replacement Using Custom Entries	23-133
Replace Math Functions Based on Computation Method ..	23-150
Map Semaphore or Mutex Operations to Target-Specific Implementations	23-152
Specify Build Information for Code Replacements	23-161
Add Code Replacement Library Reserved Identifiers	23-165
Manage CRTs with the Code Replacement Tool	23-168
Code Replacement Tool	23-168
Create Code Replacement Table for a Sample Model	23-169
Create Code Replacement Table for a Sample MATLAB Coder Project	23-176
Create and Modify Code Replacement Tables	23-183
Validate Code Replacement Tables and Table Entries	23-189
Generate a Code Replacement Registration File	23-189
Examine and Validate Code Replacement Tables	23-191
Overview of Code Replacement Table Validation	23-191
Invoke the Table Definition File	23-191
Use Code Replacement Viewer to Examine Tables	23-192
Use Code Replacement Viewer to Examine CRLs	23-193
Trace Code Replacements Generated Using Your CRL	23-195
Determine Why Code Replacement Functions Not Used ..	23-198
Register Code Replacement Libraries	23-203
Overview of CRL Registration	23-203
Register CRL with Simulink Software (sl_customization)	23-204
Register CRL with MATLAB Coder Software (rtwTargetInfo)	23-208
Register Multiple CRLs	23-210
Custom Code Substitution for MATLAB Functions	
Using Code Replacement Libraries	23-212
Replace MATLAB Function with Custom Code	23-213
At the Command Line Using the codegen Function	23-213
Specify a Code Replacement Function in a MATLAB Coder Project	23-217

Enable the Code Replacements Report	23-219
In a MATLAB Coder Project	23-219
At the Command Line	23-219
See Also	23-220
Viewing Code Replacements in the Generated Code ..	23-221
See Also	23-222
Replace MATLAB Function Block Code with Custom Code	23-223
Code Replacement Library Limitations	23-229

Performance

Configuration

24

Configure Code Optimizations	24-2
Set Hardware Implementation Parameters	24-5
Use External Mode with the ERT Target	24-6
Memory Management	24-6
Generation of Pure Integer Code with External Mode	24-7

Data Copy Reduction

25

Use Virtualized Output Ports Optimization	25-2
Control Signal Storage	25-4

Execution Speed

26

Remove Initialization Code	26-2
Generate Pure Integer Code If Possible	26-4
Disable MAT-File Logging	26-5
Simplify Multiply Operations In Array Indexing	26-6
Generated Code Results	26-6

Memory Usage

27

Optimize Generated Code Using Specified Minimum and Maximum Values	27-2
How to Configure Your Model	27-2
How to Enable Optimization	27-3
Optimize Generated Code Using Specified Minimum and Maximum Values	27-4
Limitations	27-6
Reduce Global Variables in Nonreusable Subsystem Functions	27-8
Generate void-void Function	27-8
Generate Function with Arguments	27-9

Verification

Code Tracing

28

About Code Tracing	28-2
---------------------------------	-------------

Format of Traceability Tags	28-3
Examples of Tagged Code	28-3
Trace Code to Model Objects Using Hyperlinks	28-4
Trace Model Objects to Generated Code	28-6
Reload Existing Traceability Information	28-8
Customize Traceability Reports	28-10
Generate a Traceability Matrix	28-12
Traceability Limitations	28-13

Component Verification

29

Component Verification in the Target Environment ..	29-2
Goals of Component Verification	29-3
Maximizing Code Portability and Configurability	29-4
Simplifying Code Integration and Maximizing Code Efficiency	29-5
Running Component Tests	29-7

Component Verification With a Real-Time Target Environment

30

About Real-Time Software Component Verification . . .	30-2
Real-Time Software Component Testing	30-4

Numerical Equivalence Checking

31

About SIL and PIL Simulations	31-2
Overview	31-2
What are SIL and PIL Simulations?	31-2
Why Use SIL and PIL	31-3
How SIL and PIL Simulations Work	31-6
Comparison of SIL and PIL Simulation	31-7
Choose a SIL or PIL Approach	31-9
About Choosing a SIL or PIL Simulation	31-9
When to Use Top-Model SIL or PIL	31-9
When to Use Model Block SIL or PIL	31-9
When to Use the SIL or PIL Block	31-13
Configure a SIL or PIL Simulation	31-15
Top-Model SIL or PIL Simulation	31-15
Model Block SIL or PIL Simulation	31-17
Use a SIL or PIL Block	31-19
Verify a SIL or PIL Configuration	31-20
Top Model Simulation Using SIL or PIL	31-23
Referenced Model Simulation Using SIL or PIL	31-24
Verify Internal Signals of a Component	31-24

Simulation Mode Override Behavior in Model Reference Hierarchy	31-25
Code Interfaces for SIL and PIL	31-28
Code Interface for Top-Model SIL or PIL	31-28
Code Interface for Model Block SIL or PIL	31-29
Configure Hardware Implementation Settings for SIL	31-30
Choose Hardware Implementation Options	31-30
Portable Word Sizes	31-30
Emulation Hardware	31-34
Embedded hardware configured for host	31-35
Debugging During SIL Simulations	31-36
Programming PIL Support Using Third-Party Tools ..	31-39
Create a Connectivity Configuration for a Target	31-40
What Is a PIL Connectivity Configuration?	31-40
Overview of the Target Connectivity API	31-41
Create a Connectivity API Implementation	31-46
Register a Connectivity API Implementation	31-47
Synchronize Host and Target	31-47
Specify Hardware Timer	31-48
Examples of the Target Connectivity API	31-51
View Test Harness in Code Generation Report	31-53
SIL and PIL Simulation Support and Limitations	31-55
About SIL and PIL Simulation Support and Limitations ..	31-56
Code Source Support	31-57
Block Support	31-60
Configuration Parameters Support	31-62
I/O Support	31-70
Hardware Implementation Support	31-82
Other Feature Support	31-84
Programmatic Code Generation Verification	31-85
Code Generation Verification API Overview	31-85

Verify Numerical Equivalence with CGV	31-85
Verify Numerical Equivalence Between Two Modes of Execution of a Model	31-86
Plot Output Signals	31-93

Code Coverage

32

Code Coverage in SIL and PIL Simulations	32-2
Configure SIL and PIL Code Coverage	32-2
View Code Coverage Information at the End of SIL or PIL Simulations	32-4
Configure Code Coverage Programmatically	32-7
Code Coverage for PIL	32-9
PIL Support for LDRA Testbed	32-9
PIL Support for BullseyeCoverage	32-10
Code Coverage Summary and Annotations	32-11
LDRA Testbed Coverage	32-11
BullseyeCoverage Information	32-14
Code Coverage Tool Support	32-17
Tips and Limitations	32-18
Compiler and Platform Support for SIL	32-18
Right-Click Subsystem Build Unsupported for Code Coverage	32-18
BullseyeCoverage License Wait	32-18
Current Working Folder Cannot be UNC Path	32-18
Characters in matlabroot and File Path	32-18
Header Files with Identical Names	32-19
Code Coverage for Source Files in Shared Utility Folders	32-19
BullseyeCoverage Behavior with Inline Macros	32-19
SIL and PIL Simulations with Open LDRA Testbed	32-20
PIL Zero Coverage LDRA Testbed Annotations	32-20

Modify Legacy Code	32-20
--------------------------	-------

Code Execution Profiling

33

About Code Execution Profiling	33-2
Configure Code Execution Profiling	33-3
Execution Profiling for Atomic Subsystems and Model Reference Hierarchies	33-5
View and Compare Code Execution Times	33-7
Analyze Code Execution Data	33-14
Tips and Limitations	33-16
Triggered Model Block	33-16
Outliers in Execution Time Profiles	33-16
Use of Hardware-Specific Timer	33-16

Embedded IDEs and Embedded Targets

Getting Started with Embedded Targets

34

Add Support for Hardware and Software	34-2
Start Support Package Installer	34-3
Open or Reopen Support Package Examples	34-5
Install a Support Package on Multiple Computers	34-7

Project and Build Configurations for Embedded Targets

35

Model Setup	35-2
Block Selection	35-2
Configure Target Hardware Resources	35-3
Configuration Parameters	35-5
Model Reference	35-14
IDE Projects	35-16
Support for Third Party Products	35-16
Third Party Product Setup	35-16
Code Generation and Build	35-18
Automation of IDE Tasks and Processes	35-19
Makefiles for Software Build Tool Chains	35-21
What is the XMakefile Feature	35-21
Using Makefiles to Generate and Build Software	35-25
Making an XMakefile Configuration Operational	35-28
Creating a New XMakefile Configuration	35-28
XMakefile User Configuration dialog	35-34

Verification and Profiling Code Generated for Embedded Targets

36

Processor-in-the-Loop (PIL) Simulation	36-2
Overview	36-2
PIL Approaches	36-3
Communications	36-8
Running Your PIL Application to Perform Simulation and Verification	36-14
Performing a Model Block PIL Simulation via SCI Using Makefiles	36-14
Definitions	36-18
PIL Issues and Limitations	36-19

Execution Profiling for Embedded Targets	36-21
What Is Execution Profiling?	36-21
Feature Support	36-21
Execution Profiling during Standalone Execution	36-22
Execution Profiling during PIL Simulation	36-25
Stack Profiling for Embedded Targets	36-28
Feature Support	36-28
What is Stack Profiling?	36-28
Profiling System Stack Use	36-30

Processor-Specific Optimizations for Embedded Targets

37

Code Replacement Library (CRL)	37-2
About Code Replacement Libraries and Optimization	37-2
Using a Processor-Specific Code Replacement Library to Optimize Code	37-4
Process of Determining Optimization Effects Using Real-Time Profiling Capability	37-4
Reviewing Processor-Specific Code Replacement Library Changes in Generated Code	37-5
Creating Your Own Code Replacement Library	37-8
Reviewing Code Replacement Library Operators and Functions	37-8
Tips and Limitations	37-10

Working with Analog Devices VisualDSP++ IDE

38

Install Support for Analog Devices DSPs	38-2
Getting Started	38-4
Overview	38-4
Software Structure and Components	38-5

Software Requirements	38-7
Installation and Configuration	38-7
IDE Automation Interface	38-9
Getting Started with IDE Automation Interface	38-9
Constructing Objects	38-24
Properties and Property Values	38-25
adivdsp Object Properties	38-28
IDE Project Generator	38-32
Introducing IDE Project Generator	38-32
Generate an IDE Project	38-33
Model Reference	38-36
Reported Limitations and Tips	38-40
Reported Issues	38-40

Working with Eclipse IDE

39

Installing Third-Party Software for Eclipse	39-2
Tested Software Versions	39-2
Installing Oracle Java Runtime Environment (JRE)	39-3
Installing Eclipse IDE for C/C++ Developers	39-5
Verifying the GNU Tool Chain on Linux Host	39-6
Installing the GNU Tool Chain on Windows	39-7
Configuring Your MathWorks Software to Work with Eclipse	39-10
Additional Configuration Steps to Run Your Executable on a Remote Embedded Linux Target	39-13
Troubleshooting with Eclipse IDE	39-15
Profiling for ARM® Processors Running Embedded Linux Operating System	39-15
SIGSEGV Segmentation Fault for GDB	39-16
GDB Stops on Each Semaphore Post	39-16
Build Errors	39-16

Profiling Not Available for Intel x86/Pentium and AMD K5/K6/Athlon Processors Running Windows or Linux Operating Systems	39-17
Eclipse Message: “Can’t find a source file”	39-17
Eclipse Message: “Cannot access memory at address”	39-18
Some Versions of Eclipse CDT Do Not Catch GCC Errors	39-18

Working with Green Hills MULTI IDE

40

Install Support for Green Hills MULTI IDE	40-2
Getting Started	40-4
Overview	40-4
Software Structure and Components	40-5
IDE Automation Interface	40-12
Getting Started with IDE Automation Interface	40-12
Constructing Objects	40-28
Properties and Property Values	40-29
ghsmulti Object Properties	40-32
IDE Project Generator	40-35
Introducing IDE Project Generator	40-35
Generate an IDE Project	40-36
Model Reference	40-40
Breakpoints and PIL	40-44

Working with Linux Target

41

Disambiguation	41-2
-----------------------------	------

Preparing Models to Run on Linux Target	41-3
Scheduler	41-4
Base Rate	41-4
Running Target Applications on Multicore Processors	41-4
Avoiding Lock-Up in Free-Running, Multirate, Multitasking Models	41-11
Build on BeagleBoard Hardware	41-13
Overview	41-13
Configure the Windows Host	41-13
Configure the BeagleBoard Hardware	41-13
Configure MATLAB Software	41-14
Build on Linux Host and Run on BeagleBoard	
Hardware	41-15
Overview	41-15
Prerequisites	41-15
Set up your environment for Linux-ARM Code	
Generation	41-15
Generate Code for Linux-ARM	41-18
External Mode Simulation	41-18

Working with Texas Instruments Code Composer Studio 3.3 IDE

42

Code Composer Studio	42-2
Using Code Composer Studio with Embedded Coder	
Software	42-2
Default Project Configuration	42-2
Getting Started	42-4
Overview	42-4
Verifying Your Code Composer Studio Installation	42-7
IDE Automation Interface	42-9
Getting Started with IDE Automation Interface	42-9

Getting Started with RTDX	42-27
Constructing ticcs Objects	42-48
ticcs Properties and Property Values	42-49
Overloaded Functions for ticcs Objects	42-50
ticcs Object Properties	42-50
IDE Project Generator	42-58
Introducing IDE Project Generator	42-58
IDE Project Generator and Board Selection	42-58
Generate an IDE Project	42-60
Model Reference	42-64
Exporting Filter Coefficients from FDATool	42-69
About FDATool	42-69
Preparing to Export Filter Coefficients to Code Composer	
Studio Projects	42-70
Exporting Filter Coefficients to Your Code Composer Studio	
Project	42-74
Preventing Memory Corruption When You Export	
Coefficients to Processor Memory	42-80
Using Makefiles with Code Composer Studio 3.x	42-87
Introduction	42-87
Set Up XMakefile for CCSv3	42-87
Prepare Your Model for CCSv3 and Makefiles	42-89
Create Target Configuration File in CCSv3	42-89
Load and Run the Embedded Software	42-90
Reported Limitations and Tips	42-92
Example Programs Do Not Run Well with Incorrect GEL	
Files	42-93
Changing Values of Local Variables Does Not Work	42-93
Code Composer Studio Cannot Find a File After You Halt a	
Program	42-94
C54x XPC Register Can Be Modified Only Through the PC	
Register	42-95
Working with More Than One Installed Version of Code	
Composer Studio	42-96
Changing CCS Versions During a MATLAB Session	42-96
MATLAB Hangs When Code Composer Studio Cannot Find	
a Board	42-96
Using Mapped Drives	42-98

Uninstalling Code Composer Studio 3.3 Prevents Embedded Coder From Connecting	42-98
PostCodeGenCommand Commands Do Not Apply to IDE Projects	42-98

Working with Texas Instruments Code Composer Studio 4 & 5 IDE

43

Code Composer Studio	43-2
Feature Support	43-2
Getting Started	43-3
Verifying Your Code Composer Studio Installation	43-3
Learning About Makefiles	43-3
Using Makefiles with Code Composer Studio 4 & 5	43-4
Introduction	43-4
Set Up XMakefile for CCSv4/5	43-4
Prepare Your Model for CCSv4/5 and Makefiles	43-6
Create Target Configuration File in CCSv4/5	43-6
Configure Windows Path for TI Debug Server Scripting (DSS)	43-7
Load and Run the Embedded Software Using DSS	43-7
Reported Limitations and Tips	43-10
Example Programs Do Not Run well with Incorrect GEL Files	43-10
PostCodeGenCommand Commands Do Not Apply to IDE Projects	43-10

Working with Texas Instruments C2000 Processors

44

Setting Up and Configuring	44-3
Feature Support for Code Composer Studio	44-3
Installing and Configuring Software	44-3
Verifying the Configuration	44-4
Data Type Support	44-6
Scheduling and Timing	44-7
Overview	44-7
Timer-Based Interrupt Processing	44-7
Asynchronous Scheduling	44-8
Sharing General Purpose Timers between C281x Peripherals	44-13
Sharing General Purpose Timers between CAP and eCAN	44-14
Sharing General Purpose Timers between CAP and SPI ..	44-18
Overview of Creating Models for C2000 Processors ...	44-22
Accessing the Embedded Coder Block Library	44-22
Building Your Model	44-22
Using the c2000lib Blockset	44-24
Introduction	44-24
Hardware Setup	44-24
Starting the c2000lib Library	44-25
Setting Up the Model	44-25
Adding Blocks to the Model	44-26
Generating Code from the Model	44-28
Configuring Timing Parameters for CAN Blocks	44-30
The CAN Blocks	44-30
Setting Timing Parameters	44-30
Parameter Tuning and Signal Logging	44-36
ADC-PWM Synchronization via ADC Interrupt	44-49

Run the model using CCSv3	44-51
Run the model using CCSv4	44-51
Run the model using CCSv5	44-52
Configuring Acquisition Window Width for ADC	
Blocks	44-54
What Is an Acquisition Window?	44-54
Configuring ADC Parameters for Acquisition Window Width	44-56
Real-Time Data Exchange via RTDX™	44-61
SPI-Based Control of PWM Duty Cycle	44-63
HIL Verification of IIR Filter via SCI	44-67
CAN-Based Control of PWM Duty Cycle	44-74
CAN Calibration Protocol and External Mode	44-77
Using the I2C Bus to Access a Connected EEPROM ...	44-85
Using the IQmath Library	44-90
About the IQmath Library	44-90
Fixed-Point Numbers	44-91
Building Models	44-96
Programming Flash Memory	44-99
Introduction	44-99
Installing TI Flash APIs	44-100
Configuring the DSP Board Bootloader	44-100
Configuring the Software for Automatic Flash Programming	44-101
Selectively Erase, Program, or Verify Specific Flash Sectors	44-101
Placing Additional Code or Data on Unused Flash Sectors	44-102
Configuring LIN Communications	44-105

Overview	44-105
Configuring Your Model	44-105
Tips and Limitations	44-108
Texas Instruments C28x DMC Blocks Require CRL	44-108

Working with Texas Instruments C6000 Processors

45

Getting Started	45-2
Feature Support for Code Composer Studio	45-2
Overview	45-2
Using This Guide	45-3
Configuration Information	45-4
Setting Up and Configuring	45-4
Targeting C6000 DSP Hardware	45-8
Introduction to Targeting	45-8
C6000 and Code Composer Studio IDE	45-9
Targeting — Single Rate Application	45-12
Schedulers and Timing	45-19
Model Reference and Embedded Coder Software	45-29
Targeting Supported Boards	45-33
Simulink Models and Targeting	45-38
Targeting — A More Complex Application	45-38
Targeting Your C6713 DSK and Other Hardware	45-44
Creating Code Composer Studio Projects Without Building	45-47
Targeting Custom Hardware	45-49
Using Embedded Coder Software	45-62
Targeting with DSP/BIOS Options	45-64
Introducing DSP/BIOS	45-64
DSP/BIOS and Targeting Your C6000 DSP	45-65
Code Generation with DSP/BIOS	45-68
Profiling Generated Code	45-72
Generating Code for C64x+ Processors or Boards	45-85

Using the C62x and C64x DSP Libraries	45-89
About the C62x and C64x DSP Libraries	45-89
Fixed-Point Numbers	45-91
Building Models	45-96
Configuring Timing Parameters for CAN Blocks	45-98
Setting Timing Parameters	45-98
Hardware Issues	45-102
Configuring the D.signT DSK-91C111 to Use TCP/IP and UDP	45-102
Requirements for the DM642 EVM	45-102
Installing and Configuring the Avnet Board Support Library	45-105
Continuing Issues with Embedded Coder Software	45-107

Working with Wind River VxWorks RTOS

46

Overview of Support for Wind River VxWorks	
Target	46-2
Building and Running Embedded Software on VxWorks	
Target	46-4
Install and Set Up the Wind River Development Environment	46-4
Setting VxWorks Environment Variables and Starting MATLAB	46-5
Setting Up XMakefile for VxWorks Target	46-6
Customizing XMakefile to Automatically Download and Build Your Software	46-7
Prepare Your Model for VxWorks Target and Makefiles ..	46-8
Build Your Embedded Software	46-8
Working with Other Processors	46-9
Schedulers	46-10
Running Target Applications on Multicore Processors	46-10

Install Support for Xilinx Zynq Platform	47-2
Open Block Library for Xilinx Zynq Platform	47-5
Build and Run Executable on Xilinx Zynq Platform ...	47-7
Set the model Configuration Parameters	47-7
Set up the XMakefile User Configuration	47-10
Build and Run the Executable	47-11
Troubleshooting a Connection Error	47-13
Stop or Restart Executable Running on Xilinx Zynq Platform	47-14
Tune and Monitor Executable Running on Xilinx Zynq Platform	47-15
Overview of Using External Mode	47-15
Configure Simulink Model for External Mode	47-16
Run Executable on Zynq Platform	47-18
Stop External Mode	47-20
Set up Xilinx Zynq Platform and Software	47-22
Get IP Address of Xilinx Zynq Platform	47-25
Open Serial Command-line Session with Xilinx Zynq Platform	47-27

Bug Reports

Check Bug Reports for Issues and Fixes

Software is inherently complex and is not free of errors. The output of a code generator might contain bugs, some of which are not detected by a compiler. MathWorks reports critical known bugs brought to its attention on its Bug Report system at <http://www.mathworks.com/support/bugreports/>. Use the **Saved Searches and Watched Bugs** tool with the search phrase “Incorrect Code Generation” to obtain a report of known bugs that produce code that might compile and execute, but still produce wrong answers. Enter the search phrase "Simulation And Code Generation Mismatch" to obtain a report of known bugs where the output of the simulation differs from the output of the generated code.

The bug reports are an integral part of the documentation for each release. Examine periodically all bug reports for a release, as such reports may identify inconsistencies between the actual behavior of a release you are using and the behavior described in this documentation.

In addition to reviewing bug reports, you should implement a verification and validation strategy to identify potential bugs in your design, code, and tools.

Model Architecture and Design

- Chapter 2, “Modeling Environment”
- Chapter 3, “Application Objectives”
- Chapter 4, “Guidelines and Standards”
- Chapter 5, “Patterns for C Code”
- Chapter 6, “Variant Systems”
- Chapter 7, “Scheduling Considerations”

Modeling Environment

Set Up Your Modeling Environment

When developing a system, use a combination of products to model each system component based on the domain to which it applies.

The following table guides you to information and examples that pertain to use of the Embedded Coder® product to meet goals for specific domains.

Goals	Related Product Information	Examples
Generate a software design description	“Code Generation” in the Simulink® Report Generator™ documentation	rtwdemo_codegenrpt
Trace model requirements to generated code	“Requirements Traceability” in the Simulink Verification and Validation™ documentation	rtwdemo_requirements
Implement application on fixed-point processors	“Data Types and Scaling” and “Fixed-Point Code Generation” in the Fixed-Point Designer™ documentation	rtwdemo_fixpt1 rtwdemo_fuelsys_fxp_publish rtwdemo_dspanc_fixpt
Use an integrated development environment (IDE) to integrate an application on a target processor automatically	“Program Building, Interaction, and Debugging” topics in the Embedded Coder documentation “Program Building, Interaction, and Debugging” and Desktop Targets topics in the	In rtw demos, select one of the following folders: Desktop IDEs , Desktop Targets , Embedded IDEs , or Embedded Targets

Goals	Related Product Information	Examples
	Simulink Coder™ documentation	

Application Objectives

The first step in applying Embedded Coder configuration options to the application development process is to consider how your application objectives, particularly with respect to efficiency, traceability, and safety, map to code generation options in a model configuration set.

Parameters that you set in the **Solver**, **Data Import/Export**, **Diagnostics**, and **Code Generation** panes of the Configuration Parameters dialog box affect the behavior of a model in simulation and the code generated for the model.

Consider questions such as the following:

- What settings might help you debug your application?
- What is the highest objective for your application — efficiency, traceability, extra safety precaution, debugging, or some other criteria?
- What is the second highest objective?
- Can the objective at the start of the project differ from the objective required for the end result? What tradeoffs can you make?

After you answer these questions:

- 1** Define your objectives in the configuration set. For more information, see “High-Level Code Generation Objectives” on page 14-3.
- 2** Use the Code Generation Advisor to identify parameter values that are not configured for the objectives that you selected. For more information, see “Determine Model Configuration for Specified Objectives” on page 14-5.

Guidelines and Standards

- “What Are the Standards and Guidelines?” on page 4-2
- “MAAB Guidelines” on page 4-4
- “MISRA C Guidelines” on page 4-5
- “IEC 61508 Standard” on page 4-7
- “ISO 26262 Standard” on page 4-9
- “DO-178C Standard” on page 4-11

What Are the Standards and Guidelines?

If your application has mission-critical development and certification goals, your models or subsystems and the code generated for them might need to comply with one or more of the standards and guidelines listed in the following table.

Standard or Guidelines	Organization	For More Information, See...
Guidelines: Use of MATLAB®, Simulink, and Stateflow® software for control algorithm modeling – MathWorks® Automotive Advisory Board (MAAB) Guidelines	MAAB	<ul style="list-style-type: none"> • Control Algorithm Modeling Guidelines Using MATLAB, Simulink, and Stateflow Software: PDF, Word • Develop Models and Code That Comply with “MAAB Guidelines” on page 4-4
Guidelines: Use of the C Language in Critical Systems (MISRA C® ¹)	Motor Industry Software Reliability Association (MISRA)	<ul style="list-style-type: none"> • MISRA C Web site • Technical Solution 1-1IFP0W on the MathWorks Web site • Develop Models and Code That Comply with “MISRA C Guidelines” on page 4-5
Standard: AUTomotive Open System ARchitecture (AUTOSAR)	AUTOSAR Development Partnership	<ul style="list-style-type: none"> • Publications and specifications available from the AUTOSAR Web site • Technical Solution 1-2WFS27 on the MathWorks Web site • “Overview of AUTOSAR Support” on page 17-2

1. MISRA® and MISRA C® are registered trademarks of MISRA® Ltd., held on behalf of the MISRA® Consortium.

Standard or Guidelines	Organization	For More Information, See...
Standard: IEC 61508, Functional safety of electrical/electronic/programmable electronic safety-related systems	International Electrotechnical Commission	<ul style="list-style-type: none"> • IEC functional safety zone Web site • Model-Based Design for IEC 61508 (Excerpts) — For the complete document, see Technical Solution 1-32COJP on the MathWorks Web site. • Develop Models and Code That Comply with “IEC 61508 Standard” on page 4-7
Standard: ISO 26262, Road Vehicles - Functional Safety	International Organization for Standardization	<ul style="list-style-type: none"> • ISO 26262 Support in MATLAB and Simulink • Develop Models and Code That Comply with “ISO 26262 Standard” on page 4-9
Standard: DO-178C, Software Considerations in Airborne Systems and Equipment Certification	Radio Technical Commission for Aeronautics (RTCA)	<ul style="list-style-type: none"> • Develop Models and Code That Comply with “DO-178C Standard” on page 4-11

For information on whether Simulink Coder technology is certified or qualified and whether safety-critical software has been developed with MathWorks tools, see Embedded Coder — Code Certification with MathWorks Tools.

MAAB Guidelines

The MathWorks Automotive Advisory Board (MAAB) involves major automotive OEMs and suppliers in the process of evolving MathWorks controls, simulation, and code generation products, including Simulink, Stateflow, and Simulink Coder. An important result of the MAAB has been the “MAAB Control Algorithm Modeling” guidelines..

If you have a Simulink Verification and Validation product license, you can check that your Simulink model or subsystem, and the code that you generate from it, complies with MAAB guidelines. To check your model or subsystem, open the Simulink Model Advisor. Navigate to **By Product > Simulink Verification and Validation > Modeling Standards > MathWorks Automotive Advisory Board Checks** and run the MathWorks Automotive Advisory Board checks.

For more information on using the Model Advisor, see “Consult the Model Advisor” in the Simulink documentation.

MISRA C Guidelines

The Motor Industry Software Reliability Association (MISRA²) has established “Guidelines for the Use of the C Language in Critical Systems” (MISRA C). For general information about MISRA C, see www.misra-c.com.

In 1998, MIRA Ltd. published MISRA C (MISRA C:1998) to provide a restricted subset of a standardized, structured language that met Safety Integrity Level (SIL) 2 and higher. A major update based on feedback was published in 2004 (MISRA C:2004), followed by a minor update in 2007 known as Technical Corrigendum (TC1). In 2007, MISRA also published the MISRA AC AGC standard, “MISRA AC AGC: Guidelines for the Application of MISRA-C:2004 in the Context of Automatic Code Generation.” MISRA AC AGC does not change MISRA C:2004 rules, rather it modifies the adherence recommendation. For more information about MISRA C, see www.misra-c.com.

Embedded Coder and Simulink offer capabilities to minimize the potential for MISRA C rule violations, especially rules deemed applicable by MISRA AC AGC.

To configure a model or subsystem so that the code generator is most likely to produce MISRA C:2004 compliant code, use the Code Generation Advisor. For more information, refer to:

- “High-Level Code Generation Objectives” on page 14-3
- “Determine Model Configuration for Specified Objectives” on page 14-5

The Model Advisor also checks that you developed your model or subsystem to increase the likelihood of generating MISRA C:2004 compliant code. To check your model or subsystem:

- 1** Open the Model Advisor.
- 2** Navigate to **By Product > Embedded Coder**.
- 3** Run the following checks:

2. MISRA® and MISRA C® are registered trademarks of MIRA Ltd., held on behalf of the MISRA® Consortium.

- “Check for blocks not recommended for MISRA-C:2004 compliance”
- “Check configuration parameters for MISRA-C:2004 compliance”

For more information about using the Model Advisor, see “Consult the Model Advisor” in the Simulink documentation.

For information about using Embedded Coder software within MISRA C guidelines, see Technical Solution 1-1IFP0W on the MathWorks Web site.

IEC 61508 Standard

In this section...

“Apply Simulink and Embedded Coder to the IEC 61508 Standard” on page 4-7

“Check for IEC 61508 Standard Compliance Using the Model Advisor” on page 4-7

“Validate Traceability” on page 4-12

Apply Simulink and Embedded Coder to the IEC 61508 Standard

Applying Model-Based Design to a safety-critical system requires extra consideration and rigor so that the system adheres to defined safety standards. IEC 61508, Functional safety of electrical/electronic/programmable electronic safety related systems, is such a standard. Because the standard was published when most software was coded by hand, the standard needs to be mapped to Model-Based Design technologies. Model-Based Design for IEC 61508 (Excerpts) provides a sampling of information available from a document that offers recommendations on how to apply Simulink, Simulink Coder, and third-party products for Model-Based Design to IEC 61508 measures and techniques. For the complete version of Model-Based Design for IEC 61508, see Technical Solution 1-32COJP on the MathWorks Web site.

MathWorks provides an IEC Certification Kit product that you can use to certify MathWorks code generation and verification tools for projects based on the IEC 61508 standard. For more information, see <http://www.mathworks.com/products/iec-61508/>.

Check for IEC 61508 Standard Compliance Using the Model Advisor

If you have a Simulink Verification and Validation product license, you can check that your Simulink model or subsystem and the code that you generate from it complies with selected aspects of the IEC 61508 standard by running the Simulink Model Advisor. Navigate to **By Product > Simulink Verification and Validation > Modeling Standards > IEC 61508** and

ISO 26262 Checks or By Task > Modeling Standards for IEC 61508 and run the “IEC 61508 and ISO 26262 Checks”.

For more information on using the Model Advisor, see “Consult the Model Advisor” in the Simulink documentation.

Validate Traceability

Typically, applications that require certification require some level of traceability between requirements, models, and corresponding code.

To...	Use...
Associate requirements documents with objects in Simulink models	The “Requirements Traceability” that is available if you have a Simulink Verification and Validation license.
Trace model blocks and subsystems to generated code	The Model-to-code traceability option when generating an HTML report during the code generation or build process.
Trace generated code to model blocks and subsystems	The Code-to-model traceability option when generating an HTML report during the code generation or build process.

ISO 26262 Standard

In this section...

“Apply Simulink and Embedded Coder to the ISO 26262 Standard” on page 4-9

“Check for ISO 26262 Standard Compliance Using the Model Advisor” on page 4-9

“Validate Traceability” on page 4-12

Apply Simulink and Embedded Coder to the ISO 26262 Standard

Applying Model-Based Design to a safety-critical system requires extra consideration and rigor so that the system adheres to defined functional safety standards. ISO 26262, Road Vehicles - Functional Safety, is such a standard. For further information about MathWorks support for ISO 26262, see ISO 26262 Support in MATLAB and Simulink.

MathWorks provides an IEC Certification Kit product that you can use to qualify MathWorks code generation and verification tools for projects based on the ISO 26262 standard. For more information, see <http://www.mathworks.com/products/iso-26262/>.

Check for ISO 26262 Standard Compliance Using the Model Advisor

If you have a Simulink Verification and Validation product license, you can check that your Simulink model or subsystem and the code that you generate from it complies with selected aspects of the ISO 26262 standard by running the Simulink Model Advisor. Navigate to **By Product > Simulink Verification and Validation > Modeling Standards > IEC 61508 and ISO 26262 Checks** or **By Task > Modeling Standards for ISO 26262** and run the “IEC 61508 and ISO 26262 Checks”.

For more information on using the Model Advisor, see “Consult the Model Advisor” in the Simulink documentation.

Validate Traceability

Typically, applications that require certification require some level of traceability between requirements, models, and corresponding code.

To...	Use...
Associate requirements documents with objects in Simulink models	The “Requirements Traceability” that is available if you have a Simulink Verification and Validation license.
Trace model blocks and subsystems to generated code	The Model-to-code traceability option when generating an HTML report during the code generation or build process.
Trace generated code to model blocks and subsystems	The Code-to-model traceability option when generating an HTML report during the code generation or build process.

DO-178C Standard

In this section...
“Apply Simulink and Embedded Coder to the DO-178C Standard” on page 4-11
“Check for Standard Compliance Using the Model Advisor” on page 4-11
“Validate Traceability” on page 4-12

Apply Simulink and Embedded Coder to the DO-178C Standard

Applying Model-Based Design to a high-integrity system requires extra consideration and rigor so that the system adheres to defined safety standards. DO-178C Software Considerations in Airborne Systems and Equipment Certification is such a standard. A supplement to DO-178C, DO-331, provides guidance on the use of Model-Based Design technologies. MathWorks provides a DO Qualification Kit product that you can use to qualify MathWorks verification tools for projects based on the DO-178C, DO-331, and related standards. For more information, see <http://www.mathworks.com/products/do-178/>.

For information about Model-Based Design and MathWorks support of aerospace and defense industry standards, see <http://www.mathworks.com/aerospace-defense/>.

Check for Standard Compliance Using the Model Advisor

If you have a Simulink Verification and Validation product license, you can check that your Simulink model or subsystem and the code that you generate from it complies with selected aspects of the DO-178C standard by running the Simulink Model Advisor. Navigate to **By Product > Simulink Verification and Validation > Modeling Standards > DO-178C/DO-331 Checks** or **By Task > Modeling Standards for DO-178C/DO-331** and run the DO-178C/DO-331 checks.

For more information on using the Model Advisor, see “Consult the Model Advisor” in the Simulink documentation.

Validate Traceability

Typically, applications that require certification require some level of traceability between requirements, models, and corresponding code.

To...	Use...
Associate requirements documents with objects in Simulink models	The “Requirements Traceability” that is available if you have a Simulink Verification and Validation license.
Trace model blocks and subsystems to generated code	The Model-to-code traceability option when generating an HTML report during the code generation or build process.
Trace generated code to model blocks and subsystems	The Code-to-model traceability option when generating an HTML report during the code generation or build process.

Patterns for C Code

- “About Modeling Patterns” on page 5-3
- “Prepare a Model for Code Generation” on page 5-4
- “Data Declaration” on page 5-9
- “Data Type Conversion” on page 5-13
- “Type Qualifiers” on page 5-17
- “Relational and Logical Operators” on page 5-20
- “Bitwise Operations” on page 5-24
- “If-Else” on page 5-28
- “Switch” on page 5-35
- “For Loop” on page 5-41
- “While Loop” on page 5-50
- “Do While Loop” on page 5-62
- “Function Call” on page 5-69
- “Function Prototyping” on page 5-71
- “External C Functions” on page 5-75
- “Macro Definitions (#define)” on page 5-82
- “Conditional Inclusions (#if / #endif)” on page 5-85
- “Typedef” on page 5-86
- “Structures for Parameters” on page 5-88
- “Structures for Signals” on page 5-91
- “Nested Structures” on page 5-95

- “Bitfields” on page 5-99
- “Arrays for Parameters” on page 5-101
- “Arrays for Signals” on page 5-103
- “Pointers for Signals” on page 5-105
- “Pointers Using Simulink Data Objects” on page 5-106

About Modeling Patterns

Several standard methods are available for setting up a model to generate specific C constructs in your code. For preparing your model for code generation, some of these methods include: configuring signals and ports, initializing states, and setting up configuration parameters for code generation. Depending on the components of your model, some of these methods are optional. Methods for configuring a model to generate specific C constructs are organized by category, for example, the Control Flow category includes constructs `if-else`, `switch`, `for`, and `while`. Refer to the name of a construct to see how you should configure blocks and parameters in your model. Different modeling methodologies are available, such as Simulink blocks, Stateflow charts, and MATLAB Function blocks, to implement a C construct.

Model examples have the following naming conventions:

Model Components	Naming Convention
Inputs	u1, u2, u3, and so on
Outputs	y1, y2, y3, and so on
Parameters	p1, p2, p3, and so on
States	x1, x2, x3, and so on

Input ports are named to reflect the signal names that they propagate.

Prepare a Model for Code Generation

In this section...

“Configure a Signal” on page 5-4

“Configure Input and Output Ports” on page 5-4

“Initialize States” on page 5-5

“Set Up Configuration Parameters for Code Generation” on page 5-5

“Set Up an Example Model With a Stateflow Chart” on page 5-6

“Set Up an Example Model With a MATLAB Function Block” on page 5-7

Configure a Signal

- 1 Create a model in Simulink. For more information, see “Modeling Basics”.
- 2 Right-click a signal line. Select **Properties**. For more information about the Signal Properties dialog box, see “Signal Properties”.
- 3 Enter a signal name for the **Signal name** parameter.
- 4 On the same Signal Properties dialog box, select the **Code Generation** tab. Use the drop down menu for the **Storage class** parameter to specify a storage class. Examples in this chapter use `Exported Global`.

Note Alternatively, on the Signal Properties dialog box, select **Signal name must resolve to Simulink signal object**. Then create a signal data object in the base workspace with the same name as the signal. See “Create Simulink and mpt Data Objects” on page 8-56 for more information on creating data objects in the base workspace. (Examples use `mpt.Signal` and specify the **Storage class** as `ExportedGlobal`.)

Configure Input and Output Ports

- 1 In your model,

Double-click an Inport or Outport block. A Block Parameters dialog box opens.

- 2 Select the **Signal Attributes** tab.
- 3 Specify the **Port dimensions** and **Data type**. Examples leave the default value for **Port dimensions** as 1 (for inherited) and **Data type** as Inherit: auto.

Initialize States

- 1 Double-click a block.
- 2 In the Block Parameters dialog box, select the **Main** tab.
- 3 Specify the **Initial conditions** and **Sample time**. For more information, see “Specify Sample Time”.
- 4 Select the **State Attributes** pane. Specify the state name. See “States”.
- 5 You can also use the Data Object Wizard for creating data objects. A part of this process initializes states. See “Create Data Objects with Data Object Wizard” on page 8-57.

Set Up Configuration Parameters for Code Generation

- 1 Open the Configuration Parameter dialog box by selecting **Simulation > Model Configuration parameters**. You can also use the keyboard shortcut Ctrl+E.
- 2 Open the **Solver** pane and select
 - **Solver type**: Fixed-Step
 - **Solver**: discrete (no continuous states)
- 3 Open the **Optimization > Signals and Parameters** pane, and select the **Inline parameters** parameter.
- 4 Open the **Code Generation** pane, and specify `ert.tlc` as the **System Target File**.

- 5** Clear **Generate makefile**.
- 6** Select **Generate code only**.
- 7** Enable the HTML report generation by opening the **Code Generation > Report** pane and selecting **Create code generation report, Launch report automatically**, and **Code-to-model**. Enabling the HTML report generation is optional.
- 8** Click **Apply** and then **OK** to exit.

Set Up an Example Model With a Stateflow Chart

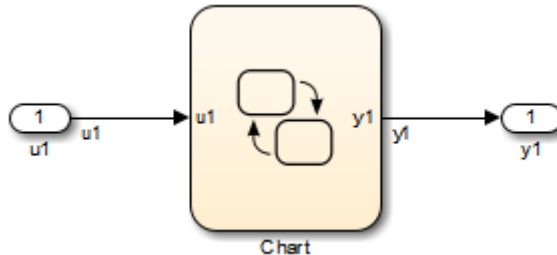

Follow this general procedure to create a simple model containing a Stateflow chart.

- 1** From the **Stateflow > Chart** library, add a Stateflow chart to your model .
- 2** Add Inport blocks and Outport blocks according to the example model.
- 3** Open the **Stateflow Editor** by performing one of the following:
 - Double-click the Stateflow chart.
 - Press **Ctrl+R**.
- 4** Select **Chart > Add Inputs & Outputs > Data Input from Simulink** to add the inputs to the chart. A Data dialog box opens for each input.
- 5** Specify the **Name** (u1, u2, ...) and the **Type** (Inherit: Same as Simulink) for each input, unless specified differently in the example. Click **OK**.

Click **Apply** and close each dialog box.

- 6** Select **Chart > Add Inputs & Outputs > Data Output from Simulink** to add the outputs to the chart. A Data dialog opens for each output.
- 7** Specify the **Name** (y1, y2, ...) and **Type** (Inherit: Same as Simulink) for each output, unless specified differently in the example. Click **OK**.
- 8** Click **Apply** and close each dialog box.
- 9** In the **Stateflow Editor**, create the Stateflow diagram specific to the example.
- 10** The inputs and outputs appear on the chart in your model.
- 11** Connect the Inport and Outport blocks to the Stateflow Chart.
- 12** Configure the input and output signals; see “Configure a Signal” on page 5-4.

Set Up an Example Model With a MATLAB Function Block

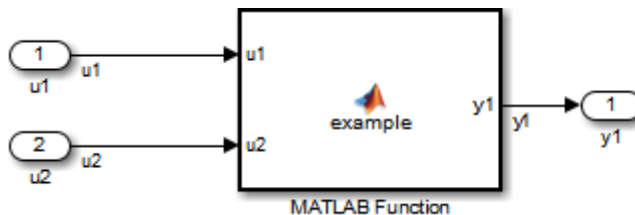

- 1** Add the number of Inport and Outport blocks according to a C construct example included in this chapter.
- 2** From the Simulink User-defined Functions library drag a MATLAB Function block into the model.
- 3** Double-click the block. The MATLAB Function Block Editor opens. Edit the function to implement your application.

- 4 Click **File > Save** and close the MATLAB Function Block Editor.
- 5 Connect the Inport and Outport blocks to the MATLAB Function block. See “Configure a Signal” on page 5-4.
- 6 Save your model.

Data Declaration

C Construct

```
int32 p1 = 3;
```

Declare a Variable for a Block Parameter Using a Data Object

You can specify certain block parameters as a variable. If you define the variable as a data object, the variable is global. Where the variable is declared in the generated code depends on the custom storage class that you choose (and whether you select **Inline Parameters** on the **Optimization > Signals and Parameters** pane). If you choose **Inline Parameters**, then the data object name is used in the generated code. If you did not choose **Inline Parameters**, the generated code creates a global structure that stores all of the parameters. For more information on how to create a data object, see “Apply User-Defined Data Types” on page 8-2.

Block	Parameter
Constant	Value
Gain	Value
For Iterator	Iteration Limit

There are several methods for configuring data objects:

- For a model with many parameters, use the Data Object Wizard, which analyzes your model and finds the unresolved data objects and data types. You can then create the data objects in the Data Object Wizard. The procedure for using the Data Object Wizard for a parameter is similar to the procedure for a signal. For an example, see “Declare a Variable for a Signal using a Data Object” on page 5-11.
- To add, delete, edit, and configure data objects, use the base workspace in the Model Explorer.
- To create and configure data objects, use the MATLAB command line.

The following example demonstrates how to create a data object using the Model Explorer. The declaration statement in the generated code is as follows:

```
int Kp = 3;
```

- 1** Create a model containing a Constant block and a Gain block.
- 2** Press **Ctrl+E** to open the Configuration Parameters dialog box.
- 3** On the **Optimization > Signals and Parameters** pane of the Configuration Parameter dialog box, select **Inline parameters**.
- 4** Click **Apply** and **OK**. The Configuration Parameter dialog box closes.
- 5** In your model, double-click the Constant block. The Block Parameters dialog box opens.
- 6** In the **Value** field, enter a variable name. In this example, the variable name is **p1**.
- 7** In your model, double-click the Gain block. The Block Parameters dialog box opens.
- 8** In the **Value** field, enter a variable name. In this example, the variable name is **p2**.
- 9** Press **Ctrl+H** to open the Model Explorer. On the Model Hierarchy pane, select the base workspace.
- 10** To add two MPT parameter objects, in the menu bar, select **Add > MPT Parameter** in the menu bar twice. On the **Contents of: Base Workspace** pane, you see the parameters.
- 11** Double-click each `mpt.Parameter` object and change their names to **p1** and **p2**.
- 12** Click the **p1** parameter. The data object parameters are displayed in the right pane of the Model Explorer.
- 13** In the **Value** field, enter **3** for **p1**. For the **Data type**, select **int32**. Because you chose an MPT parameter, the **Storage Class** is already set to **Global(Custom)**.

14 In the **Value** field, enter 5 for p2. For the **Data type**, select int32.

15 Press **Ctrl+B** to generate code.

In the *model.c* file you see:

```
int32 p1 = 3;  
int32 p2 = 5;
```

Note Depending on the storage class, the global variable is represented differently in the generated code. For more information, see “Parameter Objects”.

C Construct

```
int p1 = 3;
```

Declare a Variable for a Signal using a Data Object

- 1** Create a model and label the signals.
- 2** Open the **Data Object Wizard**. In the Simulink Editor, select **Code > Data Objects > Data Object Wizard**. If you are not familiar with creating Simulink Data Objects using the wizard, refer to “Data Object Wizard” .
- 3** Click **Find**. The list of unresolved parameters and objects populates the Data Object Wizard. You can do mass edits for identical data objects.
- 4** Select the signals individually or select all signals by clicking **Check All**.
- 5** From the parameter **Choose package for selected data objects** drop-down list, select the **mpt** package. Click **Apply Package**. When you open the Model Explorer the data objects appear in the base workspace.
- 6** In the base workspace, click the **p1** data object . The data object parameters appear in the right pane of the Model Explorer.
- 7** From the **Data type** drop-down list, select **int16**.

- 8 You can also specify the storage class. The data object is an `mpt.Parameter` object, therefore the Storage Class is automatically set to `Global (Custom)`.

Note The Storage class alters the data object implementation in the generated code. For more information, see “Signal Objects”.

Data Type Conversion

C Construct

```
y1 = (double)u1;
```

Modeling Patterns

- “Modeling Pattern for Data Type Conversion — Simulink Block” on page 5-13
- “Modeling Pattern for Data Type Conversion — Stateflow Chart” on page 5-14
- “Modeling Pattern for Data Type Conversion — MATLAB Function Block” on page 5-15

Modeling Pattern for Data Type Conversion — Simulink Block

One method to create a data type conversion is to use a Data Type Conversion block from the **Simulink > Commonly Used Blocks** library.

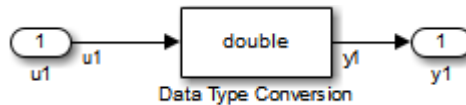

ex_data_type_SL

- 1 From the **Commonly Used Blocks** library, drag a Data Type Conversion block into your model and connect to the Inport and Output blocks.
- 2 Double-click on the Data Type Conversion block to open the Block Parameters dialog box.
- 3 Select the **Output data type** parameter as double.
- 4 Press **Ctrl+B** to build the model and generate code.

The generated code appears in `ex_data_type_SL.c`, as follows:

```
int32_T u1;
real_T y1;

void ex_data_type_SL_step(void)
{
    y1 = (real_T)u1;
}
```

The Embedded Coder type definition for double is `real_T`.

Modeling Pattern for Data Type Conversion – Stateflow Chart

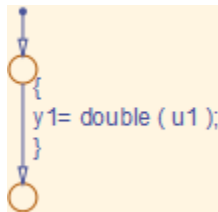

Stateflow Chart Type Conversion

Procedure

- 1 Follow the steps for “Set Up an Example Model With a Stateflow Chart” on page 5-6 . This example contains one Inport block and one Outport block.
- 2 Name the example model `ex_data_type_SF`.
- 3 Double-click the Inport block and select the **Signal Attributes** tab. Specify the **Data Type** as `int32` from the drop down menu.
- 4 Double-click the Outport block and select the **Signal Attributes** tab. Specify the **Data Type** as `Inherit: auto` from the drop down menu.
- 5 Press **Ctrl+B** to build the model and generate code.

Results

The generated code appears in `ex_data_type_SF.c`, as follows:

```
int32_T u1;
real_T y1;
void ex_data_type_SF_step(void)
{
    y1 = (real_T)u1;
}
```

Modeling Pattern for Data Type Conversion – MATLAB Function Block

Procedure

- 1 Follow the steps for “Set Up an Example Model With a MATLAB Function Block” on page 5-7 . This example model contains one Inport block and one Outport block.
- 2 Name the model `ex_data_type_ML_Func`.
- 3 In the MATLAB Function Block Editor enter the function, as follows:

```
function y1 = typeconv(u1)
y1 = double(u1);
end
```

- 4 Press **Ctrl+B** to build the model and generate code.

Results

The generated code appears in `ex_data_type_ML_func.c`, where `real32_T` is a float and `real_T` is a double. Type conversion occurs across assignments.

```
real32_T u1;
real_T y1;

void ex_data_type_ML_func_step(void)
{
    y1 = u1;
}
```

Other Type Conversions in Modeling

Type conversions can also occur on the output of blocks where the output variable is specified as a different data type. For example, in the Gain block, you can select the **Inherit via internal rule** parameter to control the output signal data type. Another example of type conversion can occur at the boundary of a Stateflow chart. You can specify the output variable as a different data type.

Type Qualifiers

Modeling Patterns for Type Qualifiers

- “Using a Tunable Parameter in the Base Workspace” on page 5-17
- “Use a Data Object of the Const Custom Storage Class” on page 5-18

Using a Tunable Parameter in the Base Workspace

A tunable parameter is a block parameter whose value can be changed at runtime. The storage class property of a parameter specifies how the parameter is declared in the generated code.



ex_type_qual

Procedure

- 1 Create a model containing a Constant block and an Outport block.
- 2 Double-click the Constant block. In the **Constant value** field, enter the parameter name p1 .
- 3 In the base workspace, create a MATLAB variable for p1 and specify its **Value** as 9.8 and its **Data type** as double.
- 4 Press **Ctrl+E** to open the Configuration Parameters dialog box and select the **Optimization > Signals and Parameters** pane.
- 5 Select the **Inline parameters** parameter, which activates the **Configure** button.
- 6 Click the **Configure** button to open the Model Parameter Configuration dialog box.
- 7 To declare a tunable parameter, from the **Source list**, select the variable p1.

- 8 Click the **Add to table** button to add p1 to the **Global (tunable) parameters** section.
- 9 Click the **Storage Class** and select Exported Global.
- 10 Click the **Storage Type Qualifier** arrow and select const.
- 11 Click **Apply** to save the changes.
- 12 Press **Ctrl+B** to build the model and generate code.

Results

The generated code appears in `ex_type_qual.c` as follows:

```
/* Exported block parameters */
const real_T p1 = 9.8;          /* Variable: p1
                               * Referenced by: '<Root>/Constant'
                               */
```

Use a Data Object of the Const Custom Storage Class

One way to create a type qualifier in the generated code is to create a data object and specify a custom storage class. Use the previous model, `ex_type_qual`, for this example. Specify p1 differently as follows:

Procedure

- 1 Press **Ctrl+H** to open the Model Explorer. On the Model Hierarchy pane, select the base workspace.
- 2 In the menu bar, select **Add > MPT Parameter** to add an MPT parameter object. The parameter is displayed in the **Contents of: Base Workspace** pane.
- 3 Double-click the `mpt.Parameter` object and change the **Name** to p1.
- 4 Click the p1 parameter which displays the data object parameters on the right pane of the Model Explorer.
- 5 In the **Value** field, enter 9.8 for p1. Specify the **Data type** as auto for 64-bit double.

- 6** You can use the different type qualifiers by selecting a custom storage class from the **Storage class** list. For this example, select **ConstVolatile (custom)**.
- 7** In the Configuration Parameters dialog box, on the **Optimization > Signals and Parameters** pane, select the **Inline parameters**.
- 8** Press **Ctrl+B** to build the model and generate code.

Results

The generated code produces the type qualifier in `ex_type_qual.c`:

```
const volatile real_T p1 = 9.8;
```

Relational and Logical Operators

Modeling Patterns for Relational and Logical Operators

- “Modeling Pattern for Relational or Logical Operators — Simulink Blocks” on page 5-20
- “Modeling Pattern for Relational and Logical Operators — Stateflow Chart” on page 5-21
- “Modeling Pattern for Relational and Logical Operators — MATLAB Function Block” on page 5-22

Modeling Pattern for Relational or Logical Operators — Simulink Blocks

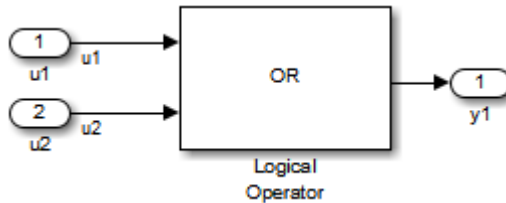

ex_logical_SL

Procedure

- 1 From the **Logic and Bit Operations** library, drag a Logical Operator block into your model.
- 2 Double-click the block to configure the logical operation. Set the **Operator** field to OR.
- 3 Name the blocks, as shown in the model `ex_logical_SL`.
- 4 Connect the blocks and name the signals, as shown in the model `ex_logical_SL`.
- 5 Press **Ctrl+B** to build the model and generate code.

Note You can use the above procedure to implement relational operators by replacing the Logical Operator block with a Relational Operator block.

Results

Code implementing the logical operator OR is in the `ex_logical_SL_step` function in `ex_logical_SL.c`:

```

/* Exported block signals */
boolean_T u1;                /* '<Root>/u1' */
boolean_T u2;                /* '<Root>/u2' */
boolean_T y1;                /* '<Root>/Logical Operator' */

/* Logic: '<Root>/Logical Operator' incorporates:
 * Inport: '<Root>/u1'
 * Inport: '<Root>/u2'
 */
y1 = (u1 || u2);

```

Modeling Pattern for Relational and Logical Operators – Stateflow Chart

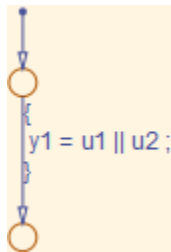

ex_logical_SF/Logical Operator Stateflow® Chart

Procedure

- 1 Follow the steps for “Set Up an Example Model With a Stateflow Chart” on page 5-6. This example model contains two Inport blocks and one Output block.

- 2** Name the example model `ex_logical_SF`.
- 3** In the **Stateflow Editor**, specify the **Data Type** for `y1` as `Boolean`.
- 4** In the **Stateflow Editor**, create the Stateflow diagram as shown. The relational or logical operation actions are on the transition from one junction to another. Relational statements specify conditions to conditionally allow a transition. In that case, the statement would be within square brackets.
- 5** Press **Ctrl+B** to build the model and generate code.

Results

Code implementing the logical operator OR is in the `ex_logical_SF_step` function in `ex_logical_SF.c`:

```
boolean_T u1;           /* '<Root>/u1' */
boolean_T u2;           /* '<Root>/u2' */
boolean_T y1;           /* '<Root>/Chart' */

void ex_logical_SF_step(void)
{
    y1 = (u1 || u2);
}
```

Modeling Pattern for Relational and Logical Operators – MATLAB Function Block

This example demonstrates the MATLAB Function block method for incorporating operators into the generated code using a relational operator.

Procedure

- 1** Follow the steps for “Set Up an Example Model With a MATLAB Function Block” on page 5-7 . This example model contains two Inport blocks and one Output block.
- 2** Name the example model `ex_rel_operator_ML`.
- 3** In the MATLAB Function Block Editor enter the function, as follows:

```
function y1 = fcn(u1, u2)
y1 = u1 > u2;
end
```

4 Press **Ctrl+B** to build the model and generate code.

Results

Code implementing the relational operator '>' is in the `ex_rel_operator_ML_step` function in `ex_rel_operator_ML.c`:

```
real_T u1;                                /* '<Root>/u1' */
real_T u2;                                /* '<Root>/u2' */
boolean_T y;                              /* '<Root>/MATLAB Function' */

void ex_rel_operator_ML_step(void)
{
    y = (u1 > u2);
}
```

Bitwise Operations

Simulink Bitwise-Operator Block

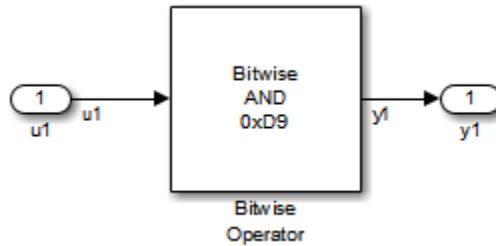

`ex_bit_logic_SL`

Procedure

- 1 Drag a Bitwise Operator block from the **Logic and Bit Operations** library into your model.
- 2 Double-click the block to open the Block Parameters dialog.
- 3 Select the type of **Operator**. In this example, select AND.
- 4 In order to perform Bitwise operations with a bit-mask, select **Use bit mask**.

Note If another input uses Bitwise operations, clear the **Use bit mask** parameter and enter the number of input ports.

- 5 In the **Bit Mask** field, enter a decimal number. Use `bin2dec` or `hex2dec` to convert from binary or hexadecimal. In this example, enter `hex2dec('D9')`.
- 6 Name the blocks, as shown in, model `ex_bit_logic_SL`.
- 7 Connect the blocks and name the signals, as shown in, model `ex_bit_logic_SL`.

8 Press **Ctrl+B** to build the model and generate code.

Results

Code implementing the logical operator OR is in the `ex_bit_logic_SL_step` function in `ex_bit_logic_SL.c`:

```
uint8_T u1;
uint8_T y1;

void ex_bit_logic_SL_step(void)
{
    y1 = (uint8_T)(u1 & 217);
}
```

Stateflow Chart

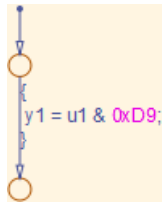

ex_bit_logic_SF/Bit_Logic Stateflow Chart

Procedure

- 1** Follow the steps for “Set Up an Example Model With a Stateflow Chart” on page 5-6. This example contains one Inport block and one Output block.
- 2** Name the example model `ex_bit_logic_SF`.
- 3** From the **Stateflow Editor**, select **Tools > Explore** to open the Model Explorer.
- 4** In the Model Explorer, on the right pane, select **Enable C-bit operations**.
- 5** In the **Stateflow Editor**, create the Stateflow diagram, `ex_bit_logic_SF/Bit_Logic`.

6 Press **Ctrl+B** to build the model and generate code.

Results

Code implementing the logical operator OR is in the `ex_bit_logic_SF_step` function in `ex_bit_logic_SF.c`:

```
uint8_T u1;
uint8_T y1;

void bit_logic_SF_step(void)
{
    y1 = (uint8_T)(u1 & 0xD9);
}
```

MATLAB Function Block

In this example, to demonstrate the MATLAB Function block method for implementing bitwise logic into the generated code, use the bitwise OR, '|'.

Procedure

- 1** Follow the steps for “Set Up an Example Model With a MATLAB Function Block” on page 5-7. This example model contains two Inport blocks and one Outport block.
- 2** Name your model `ex_bit_logic_ML`.
- 3** In the MATLAB Function Block Editor enter the function, as follows:

```
function y1 = fcn(u1, u2)

y1 = bitor(u1, u2);
end
```

- 4** Press **Ctrl+B** to build the model and generate code.

Results

Code implementing the bitwise operator OR is in the `ex_bit_logic_ML_step` function in `ex_bit_logic_ML.c`:

```
uint8_T u1;
uint8_T u2;
uint8_T y1;

void ex_bit_logic_ML_step(void)
{
    y1 = (uint8_T)(u1 | u2);
}
```

If-Else

C Construct

```
if (u1 > u2)
{
    y1 = u1;
}
else
{
    y1 = u2;
}
```

Modeling Patterns

- “Modeling Pattern for If-Else: Switch block” on page 5-29
- “Modeling Pattern for If-Else: Stateflow Chart” on page 5-31
- “Modeling Pattern for If-Else: MATLAB Function Block” on page 5-33

Modeling Pattern for If-Else: Switch block

One method to create an if-else statement is to use a Switch block from the **Simulink > Signal Routing** library.

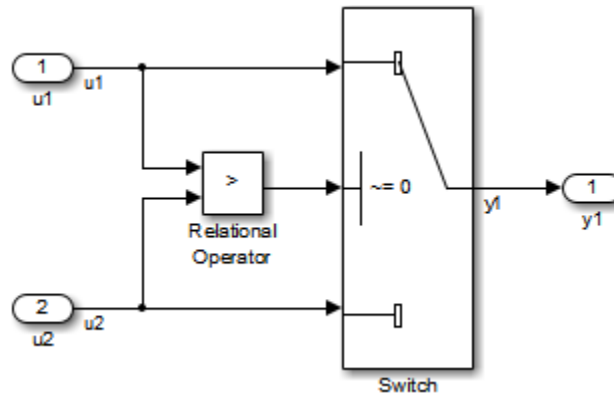

Model ex_if_else_SL

Procedure

- 1 Drag the Switch block from the **Simulink>Signal Routing** library into your model.
- 2 Connect the data inputs and outputs to the block.
- 3 Drag a Relational Operator block from the Logic & Bit Operations library into your model.
- 4 Connect the signals that are used in the if-expression to the Relational Operator block. The order of connection determines the placement of each signal in the if-expression.
- 5 Configure the Relational Operator block to be a greater than operator.
- 6 Connect the controlling input to the middle input port of the Switch block.
- 7 Double-click the Switch block and set **Criteria for passing first input** to $u2 \neq 0$. The software selects $u1$ if $u2$ is TRUE; otherwise $u2$ passes.

8 Enter Ctrl+B to build the model and generate code.

Results

The generated code includes the following `ex_if_else_SL_step` function in the file `ex_if_else_SL.c`:

```
/* External inputs (root inport signals with auto storage) */
ExternalInputs U;

/* External outputs (root outports fed by signals with auto storage) */
ExternalOutputs Y;

/* Model step function */
void ex_if_else_SL_step(void)
{
    /* Switch: '<Root>/Switch' incorporates:
     * Inport: '<Root>/u1'
     * Inport: '<Root>/u2'
     * Outport: '<Root>/y1'
     * RelationalOperator: '<Root>/Relational Operator'
     */
    if (U.u1 > U.u2) {
        Y.y1 = U.u1;
    } else {
        Y.y1 = U.u2;
    }
}
```

Modeling Pattern for If-Else: Stateflow Chart

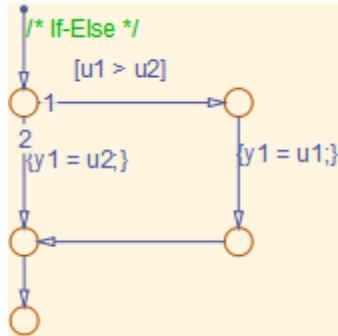

ex_if_else_SF/Chart

Procedure

- 1 Follow the steps for “Set Up an Example Model With a Stateflow Chart” on page 5-6. This example model contains two Inport blocks and one Outport block.
- 2 Name your model `ex_if_else_SF`.
- 3 When configuring your Stateflow chart, select **Chart > Add Patterns > Decision > If-Else**. The Stateflow Pattern dialog opens. Fill in the fields as follows:

Description	If-Else (optional)
If condition	<code>u1 > u2</code>
If action	<code>y1 = u1</code>
Else action	<code>y1 = u2</code>

- 4 Press **Ctrl+B** to build the model and generate code.

Results

The generated code includes the following `ex_if_else_SF_step` function in the file `If_Else_SF.c`:

```
/* External inputs (root inport signals with auto storage) */
ExternalInputs U;

/* External outputs (root outports fed by signals with auto storage) */
ExternalOutputs Y;

/* Model step function */
void ex_if_else_SF_step(void)
{
    /* Stateflow: '<Root>/Chart' incorporates:
     * Inport: '<Root>/u1'
     * Inport: '<Root>/u2'
     * Output: '<Root>/y1'
     */
    /* Gateway: Chart */
    /* During: Chart */
    /* Transition: '<S1>:14' */
    /* If-Else */
    if (U.u1 > U.u2) {
        /* Transition: '<S1>:13' */
        /* Transition: '<S1>:12' */
        Y.y1 = U.u1;

        /* Transition: '<S1>:11' */
    } else {
        /* Transition: '<S1>:10' */
        Y.y1 = U.u2;
    }

    /* Transition: '<S1>:9' */
}
```

Modeling Pattern for If-Else: MATLAB Function Block

Procedure

- 1 Follow the steps for “Set Up an Example Model With a MATLAB Function Block” on page 5-7. This example model contains two Inport blocks and one Output block.
- 2 Name your model `ex_if_else_ML`.
- 3 In the MATLAB Function Block Editor enter the function, as follows:

```
function y1 = fcn(u1, u2)
if u1 > u2;
    y1 = u1;
else y1 = u2;
end
```

- 4 Press **Ctrl+B** to build the model and generate code.

Results

The generated code includes the following `ex_if_else_ML_step` function in the file `ex_if_else_ML.c`:

```
/* External inputs (root inport signals with auto storage) */
ExternalInputs U;

/* External outputs (root outports fed by signals with auto storage) */
ExternalOutputs Y;

/* Model step function */
void ex_if_else_ML_step(void)
{
    /* MATLAB Function Block: '<Root>/MATLAB Function' incorporates:
     * Inport: '<Root>/u1'
     * Inport: '<Root>/u2'
     * Output: '<Root>/y1'
     */
    /* MATLAB Function 'MATLAB Function': '<S1>:1' */
```

```
if (U.u1 > U.u2) {
    /* '<S1>:1:4' */
    /* '<S1>:1:5' */
    Y.y1 = U.u1;
} else {
    /* '<S1>:1:6' */
    Y.y1 = U.u2;
}
}
```

Switch

C Construct

```
switch (u1)
{
  case 2:
    y1 = u2;
    break;
  case 3:
    y1 = u3;
    break;
  default:
    y1 = u4;
    break;
}
```

Modeling Patterns

- “Modeling Pattern for Switch: Switch Case block” on page 5-36
- “Modeling Pattern for Switch: MATLAB Function block” on page 5-39
- “Convert If-Elseif-Else to Switch statement” on page 5-40

Modeling Pattern for Switch: Switch Case block

One method for creating a switch statement is to use a Switch Case block from the **Simulink > Ports and Subsystems** library.

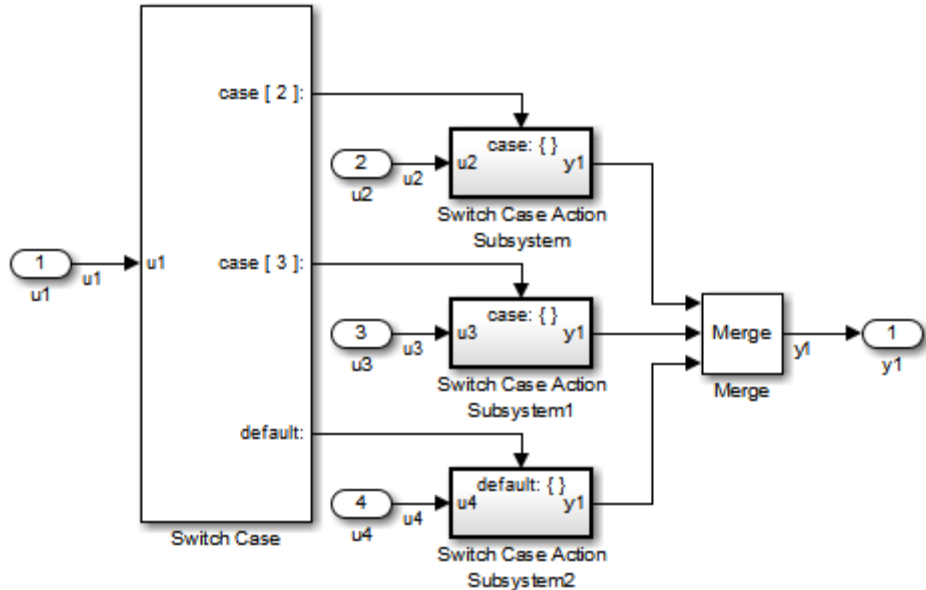

Model ex_switch_SL

Procedure

- 1 Drag a Switch Case block from the **Simulink > Ports and Subsystems** library into your model.
- 2 Double-click the block. In the Block Parameters dialog box, fill in the **Case Conditions** parameter. In this example, the two cases are: {2,3}.
- 3 Select the **Show default case** parameter. The default case is optional in a switch statement.
- 4 Connect the condition input u1 to the input port of the Switch block.
- 5 Drag Switch Case Action Subsystem blocks from the **Simulink>Ports and Subsystems** library to correspond with the number of cases.

- 6 Configure the Switch Case Action Subsystem subsystems.
- 7 Drag a Merge block from the **Simulink > Signal Routing** library to merge the outputs.
- 8 The Switch Case block takes an integer input, therefore, the input signal `u1` is type cast to an `int32`.
- 9 Enter `Ctrl+B` to build the model and generate code.

Results

The generated code includes the following `ex_switch_SL_step` function in the file `ex_switch_SL.c`:

```

/* Exported block signals */
int32_T u1;                                /* '<Root>/u1' */

/* External inputs (root inport signals with auto storage) */
ExternalInputs U;

/* External outputs (root outports fed by signals with auto storage) */
ExternalOutputs Y;

/* Model step function */
void ex_switch_SL_step(void)
{
    /* SwitchCase: '<Root>/Switch Case' incorporates:
    * ActionPort: '<S1>/Action Port'
    * ActionPort: '<S2>/Action Port'
    * ActionPort: '<S3>/Action Port'
    * Inport: '<Root>/u1'
    * SubSystem: '<Root>/Switch Case Action Subsystem'
    * SubSystem: '<Root>/Switch Case Action Subsystem1'
    * SubSystem: '<Root>/Switch Case Action Subsystem2'
    */
    switch (u1) {
        case 2:
            /* Inport: '<S1>/u2' incorporates:
            * Inport: '<Root>/u2'
            * Outport: '<Root>/y1'

```

```
    */
    Y.y1 = U.u2;
    break;

case 3:
    /* Inport: '<S2>/u3' incorporates:
     * Inport: '<Root>/u3'
     * Output: '<Root>/y1'
     */
    Y.y1 = U.u3;
    break;

default:
    /* Inport: '<S3>/u4' incorporates:
     * Inport: '<Root>/u4'
     * Output: '<Root>/y1'
     */
    Y.y1 = U.u4;
    break;
}
}
```

Modeling Pattern for Switch: MATLAB Function block

Procedure

- 1 Follow the steps for “Set Up an Example Model With a MATLAB Function Block” on page 5-7. This example model contains four Inport blocks and one Output block.
- 2 Name your model `ex_switch_ML`.
- 3 In the MATLAB Function Block Editor enter the function, as follows:

```
function y1 = fcn(u1, u2, u3, u4)

switch u1
    case 2
        y1 = u2;
    case 3
        y1 = u3;
    otherwise
        y1 = u4;
end
```

- 4 Press **Ctrl+B** to build the model and generate code.

Results

The generated code includes the following `ex_switch_ML_step` function in the file `ex_switch_ML.c`:

```
/* External inputs (root inport signals with auto storage) */
ExternalInputs U;

/* External outputs (root outports fed by signals with auto storage) */
ExternalOutputs Y;

/* Model step function */
void ex_switch_ML_step(void)
{
    /* MATLAB Function Block: '<Root>/MATLAB Function' incorporates:
```

```
* Inport: '<Root>/u1'
* Inport: '<Root>/u2'
* Inport: '<Root>/u3'
* Inport: '<Root>/u4'
* Outport: '<Root>/y1'
*/
/* MATLAB Function 'MATLAB Function': '<S1>:1' */
/* '<S1>:1:4' */
switch (U.u1) {
case 2:
/* '<S1>:1:6' */
Y.y1 = U.u2;
break;

case 3:
/* '<S1>:1:8' */
Y.y1 = U.u3;
break;

default:
/* '<S1>:1:10' */
Y.y1 = U.u4;
break;
}
}
```

Convert If-Elseif-Else to Switch statement

If a MATLAB Function block or a Stateflow chart uses `if-elseif-else` decision logic, you can convert it to a `switch` statement by using a configuration parameter. In the Configuration Parameters dialog box, on the **Code Generation > Code Style** pane, select the “Convert if-elseif-else patterns to switch-case statements” parameter. For more information, see “Converting If-Elseif-Else Code to Switch-Case Statements” in the Simulink documentation. For more information on this conversion using a Stateflow chart, see “Convert If-Elseif-Else Code to Switch-Case Statements” and “Example of Converting Code to Switch-Case Statements” in the Stateflow documentation.

For Loop

C Construct

```
y1 = 0;
for(inx = 0; inx <10; inx++)
{
    y1 = u1[inx] + y1;
}
```

Modeling Patterns:

- “Modeling Pattern for For Loop: For-Iterator Subsystem block” on page 5-42
- “Modeling Pattern for For Loop: Stateflow Chart” on page 5-45
- “Modeling Pattern for For Loop: MATLAB Function block” on page 5-48

Modeling Pattern for For Loop: For-Iterator Subsystem block

One method for creating a for loop is to use a For Iterator Subsystem block from the **Simulink > Ports and Subsystems** library.

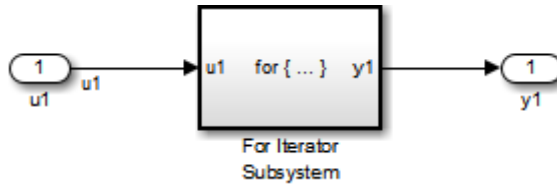

Model ex_for_loop_SL

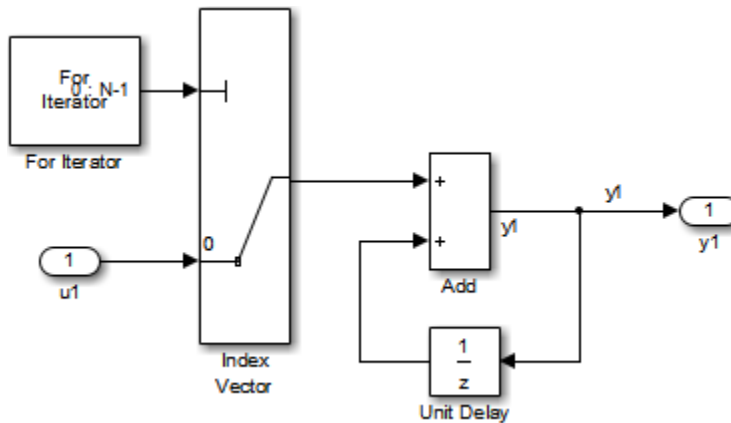

For Iterator Subsystem

Procedure

- 1 Drag a For Iterator Subsystem block from the **Simulink > Ports and Subsystems** library into your model.
- 2 Connect the data inputs and outputs to the For Iterator Subsystem block.
- 3 Open the Inport block.

- 4** In the Block Parameters dialog box, select the **Signal Attributes** pane and set the **Port dimensions** parameter to 10.
- 5** Double-click the For Iterator Subsystem block to open the subsystem.
- 6** Drag an Index Vector block from the Signal-Routing library into the subsystem.
- 7** Open the For Iterator block. In the Block Parameters dialog box set the **Index-mode** parameter to Zero-based and the **Iteration limit** parameter to 10.
- 8** Connect the controlling input to the topmost input port of the Index Vector block, and the other input to the second port.
- 9** Drag an Add block from the **Math Operations** library into the subsystem.
- 10** Drag a Unit Delay block from **Commonly Used Blocks** library into the subsystem.
- 11** Double-click the Unit Delay block and set the **Initial Conditions** parameter to 0. This parameter initializes the state to zero.
- 12** Connect the blocks as shown in the model diagram.
- 13** Save the subsystem and the model.
- 14** Enter Ctrl+B to build the model and generate code.

Results

The generated code includes the following `ex_for_loop_SL_step` function in the file `ex_for_loop_SL.c`:

```
/* External inputs (root inport signals with auto storage) */
ExternalInputs U;

/* External outputs (root outports fed by signals with auto storage) */
ExternalOutputs Y;

/* Model step function */
void ex_for_loop_SL_step(void)
```

```
{
  int32_T s1_iter;
  int32_T rtb_y1;

  /* Outputs for iterator SubSystem: '<Root>/For Iterator Subsystem' incorporates:
   * ForIterator: '<S1>/For Iterator'
   */
  /*
  for (s1_iter = 0; s1_iter < 10; s1_iter++) {
    /* Sum: '<S1>/Add' incorporates:
     * Inport: '<Root>/u1'
     * MultiPortSwitch: '<S1>/Index Vector'
     * UnitDelay: '<S1>/Unit Delay'
     */
    rtb_y1 = U.u1[s1_iter] + DWork.UnitDelay_DSTATE;

    /* Update for UnitDelay: '<S1>/Unit Delay' */
    DWork.UnitDelay_DSTATE = rtb_y1;
  }

  /* end of Outputs for SubSystem: '<Root>/For Iterator Subsystem' */

  /* Output: '<Root>/y1' */
  Y.y1 = rtb_y1;
}
```

Modeling Pattern for For Loop: Stateflow Chart

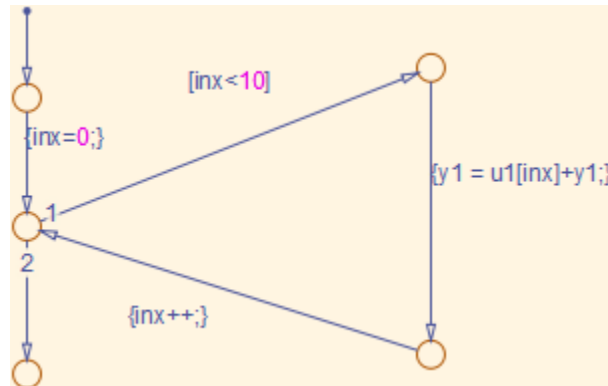

Procedure

- 1 Follow the steps for “Set Up an Example Model With a Stateflow Chart” on page 5-6. This example model contains one Inport block and one Output block.
- 2 Name the model ex_for_loop_SF.
- 3 Enter Ctrl+R to open the Model Explorer.
- 4 In the Model Explorer, select the output variable, u1, and in the right pane, select the **General** tab and set the **Initial Value** to 0.
- 5 In the **Stateflow Editor**, select **Chart > Add Patterns > Loop > For**. The Stateflow Pattern dialog opens.
- 6 Fill in the fields in the Stateflow Pattern dialog box as follows:

Description	For Loop (optional)
Initializer expression	inx = 0
Loop test expression	inx < 10

Counting expression `inx++`
For loop body `y1 = u1[inx] + y1`

The Stateflow diagram is shown.

7 Press **Ctrl+B** to build the model and generate code.

Results

The generated code includes the following `ex_for_loop_SF_step` function in the file `ex_for_loop_SF.c`:

```
/* Block signals (auto storage) */
BlockIO B;

/* External inputs (root inport signals with auto storage) */
ExternalInputs U;

/* External outputs (root outports fed by signals with auto storage) */
ExternalOutputs Y;

/* Model step function */
void ex_for_loop_SF_step(void)
{
    int32_T sf_inx;

    /* Stateflow: '<Root>/Chart' incorporates:
     * Inport: '<Root>/u1'
     */
    /* Gateway: Chart */
    /* During: Chart */
    /* Transition: '<S1>:24' */
    /* For Loop */
    /* Transition: '<S1>:25' */
    for (sf_inx = 0; sf_inx < 10; sf_inx++) {
        /* Transition: '<S1>:22' */
        /* Transition: '<S1>:23' */
        B.y1 = U.u1[sf_inx] + B.y1;

        /* Transition: '<S1>:21' */
    }
}
```

```
}  
  
/* Transition: '<S1>:20' */  
  
/* Output: '<Root>/y1' */  
Y.y1 = B.y1;  
}
```

Modeling Pattern for For Loop: MATLAB Function block

Procedure

- 1 Follow the directions for “Set Up an Example Model With a MATLAB Function Block” on page 5-7. This example model contains one Inport block and one Outport block.
- 2 Name your model `ex_for_loop_ML`.
- 3 In the MATLAB Function Block Editor enter the function, as follows:

```
function y1 = fcn(u1)

y1 = 0;

for inx=1:10
    y1 = u1(inx) + y1 ;
end
```

- 4 Press **Ctrl+B** to build the model and generate code.

Results

The generated code includes the following `ex_for_loop_ML_step` function in the file `ex_for_loop_ML.c`:

```
/* Exported block signals */
real_T u1[10];                /* '<Root>/u1' */
real_T y1;                    /* '<Root>/MATLAB Function' */

/* Model step function */
void ex_for_loop_ML_step(void)
{
    int32_T inx;

    /* MATLAB Function Block: '<Root>/MATLAB Function' incorporates:
     * Inport: '<Root>/u1'
     */
}
```

```
/* MATLAB Function 'MATLAB Function': '<S1>:1' */
/* '<S1>:1:3' */
y1 = 0.0;
for (inx = 0; inx < 10; inx++) {
    /* '<S1>:1:5' */
    /* '<S1>:1:6' */
    y1 = u1[inx] + y1;
}
}
```

While Loop

C Construct

```
while(flag && (num_iter <= 100)
{
    flag = func ();
    num_iter ++;
}
```

Modeling Patterns

- “Modeling Pattern for While Loop: While Iterator Subsystem block” on page 5-51
- “Modeling Pattern for While Loop: Stateflow Chart” on page 5-55
- “Modeling Pattern for While Loop: MATLAB Function Block” on page 5-58

Modeling Pattern for While Loop: While Iterator Subsystem block

One method for creating a while loop is to use a While Iterator Subsystem block from the **Simulink > Ports and Subsystems** library.

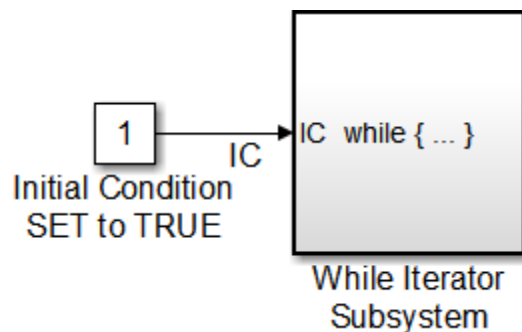

Model ex_while_loop_SL

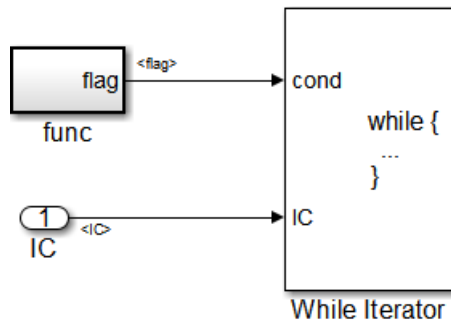

ex_while_loop_SL/While Iterator Subsystem

Procedure

- 1 Drag a While Iterator Subsystem block from the **Simulink > Ports and Subsystems** library into the model.
- 2 Drag a Constant block from the **Simulink > Commonly Used Blocks** library into the model. In this case, set the **Initial Condition** to 1 and the **Data Type** to **Boolean**. You do not have to set the initial condition to **FALSE**. The initial condition can be dependent on the input to the block.

- 3** Connect the Constant block to the While Iterator Subsystem block.
- 4** Double-click the While Iterator Subsystem block to open the subsystem.
- 5** Place a Subsystem block next to the While Iterator block.
- 6** Right-click the subsystem and select **Block Parameters (Subsystem)**. The Block Parameters dialog box opens.
- 7** Select the **Treat as atomic unit** parameter to configure the subsystem to generate a function. This enables parameters on the **Code Generation** tab.
- 8** Select the **Code Generation** tab. From the **Function packaging** list, select the option, Nonreusable function.
- 9** From the **Function name options** list, select the option, User specified. The **Function name** parameter is displayed.
- 10** Specify the name as `func`.
- 11** Click **Apply**.
- 12** Double-click the `func` subsystem block. In this example, function `func()` has an output `flag` set to 0 or 1 depending on the result of the algorithm in `func()`. Create the `func()` algorithm as shown in the following diagram:

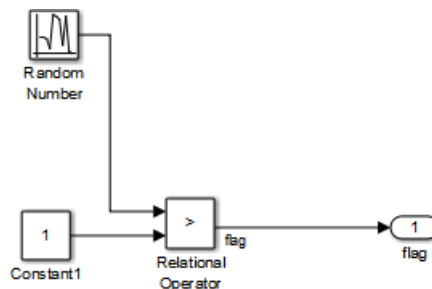
**func**

- 13** Double-click the While Iterator block to set the **Maximum number of iterations** to 100.

14 Connect blocks as shown in the model and subsystem diagrams.

Results

The generated code includes the following `ex_while_loop_SL_step` function in the file `ex_while_loop_SL.c`:

```

/* Exported block signals */
boolean_T IC;                /* '<Root>/Initial Condition SET to TRUE' */
boolean_T flag;             /* '<S2>/Relational Operator' */

/* Block states (auto storage) */
D_Work DWork;

/* Start for atomic system: '<S1>/func( ) Is a function that updates the flag' */
void func_Start(void)
{
    /* Start for RandomNumber: '<S2>/Random Number' */
    DWork.RandSeed = 1144108930U;
    DWork.NextOutput = rt_NormalRand(&DWork.RandSeed) * 1.7320508075688772E+000;
}

/* Output and update for atomic system:
 * '<S1>/func( ) Is a function that updates the flag' */
void func(void)
{
    /* RelationalOperator: '<S2>/Relational Operator' incorporates:
     * Constant: '<S2>/Constant1'
     * RandomNumber: '<S2>/Random Number'
     */
    flag = (DWork.NextOutput > 1.0);

    /* Update for RandomNumber: '<S2>/Random Number' */
    DWork.NextOutput = rt_NormalRand(&DWork.RandSeed) * 1.7320508075688772E+000;
}

/* Model step function */
void ex_while_loop_SL_step(void)
{
    int32_T s1_iter;

```

```
boolean_T loopCond;

/* Outputs for iterator SubSystem:
 *   '<Root>/While Iterator Subsystem' incorporates:
 *   WhileIterator: '<S1>/While Iterator'
 */
s1_iter = 1;
loopCond = IC;
while (loopCond && (s1_iter <= 100)) {
    /* Outputs for atomic SubSystem:
     * '<S1>/func( ) Is a function that updates the flag' */
    func();

    /* end of Outputs for SubSystem:
     * '<S1>/func( ) Is a function that updates the flag' */
    loopCond = flag;
    s1_iter++;
}

/* end of Outputs for SubSystem: '<Root>/While Iterator Subsystem' */
}
```

Modeling Pattern for While Loop: Stateflow Chart

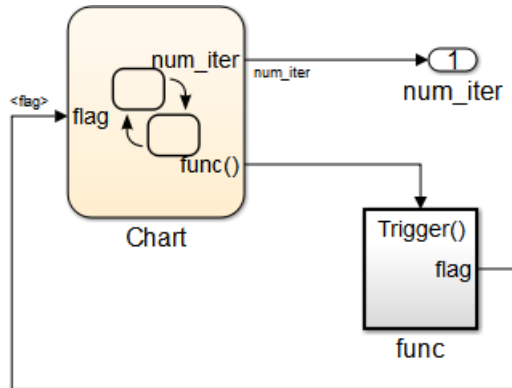

Model ex_while_loop_SF

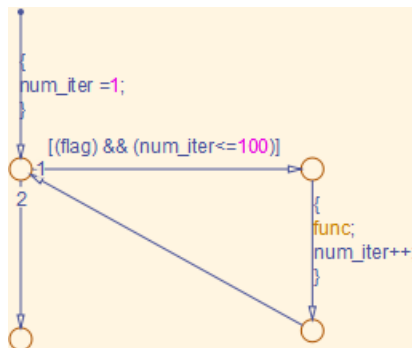

ex_while_loop_SF/Chart Executes the desired while-loop

Procedure

- 1 Add a Stateflow Chart to your model from the **Stateflow > Chart** library.
- 2 Double-click the chart.
- 3 Add the input, `flag`, and output, `func`, to the chart and specify their data type.

- 4** Connect the data input and output to the Stateflow chart as shown in the model diagram.
- 5** In the Model Explorer, select the output variable, then, in the right pane, select the **General** tab and set the **Initial Value** to 0.
- 6** Select **Chart > Add Patterns > Loop > While**. The Stateflow Pattern dialog opens.

- 7** Fill in the fields for the Stateflow Pattern dialog box as follows:

Description	While Loop (optional)
While condition	(flag) && (num_iter<=100)
Do action	func; num_iter++;

- 8** Place a Subsystem block in your model.
- 9** Right-click the subsystem and select **Block Parameters (Subsystem)**. The Block Parameters dialog box opens.
- 10** Select the **Treat as atomic unit** parameter to configure the subsystem to generate a function. This enables parameters on the **Code Generation** tab.
- 11** Select the **Code Generation** tab. From the **Function packaging** list, select the option, Nonreusable function.
- 12** From the **Function name options** list, select the option, User specified. The **Function name** parameter is displayed.
- 13** Specify the name as func.
- 14** Click **Apply** to apply the changes.
- 15** Double-click the func subsystem block. In this example, function func has an output flag set to 0 or 1 depending on the result of the algorithm in func(). The Trigger block parameter **Trigger type** is function-call. Create the func() algorithm, as shown in the following diagram:

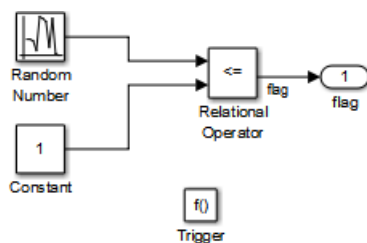

ex_while_loop_SF/func A function that updates the flag

- 16 Save and close the subsystem.
- 17 Connect blocks to the Stateflow chart as shown in the model diagram for ex_while_loop_SF.
- 18 Save your model.

Results

The generated code includes the following ex_while_loop_SF_step function in the file ex_while_loop_SF.c:

```

/* Exported block signals */
int32_T num_iter; /* '<Root>/Chart Executes the desired while-loop' */
boolean_T flag; /* '<S2>/Relational Operator' */

/* Block states (auto storage) */
D_Work DWork;

/* Model step function */
void ex_while_loop_SF_step(void)
{
  /* Stateflow: '<Root>/Chart Executes the desired
   * while-loop' incorporates:
   * SubSystem: '<Root>/func() A function that
   * updates the flag'
   */
  /* Gateway: Chart
   Executes the desired while-loop */
  /* During: Chart
   Executes the desired while-loop */
}

```

```

/* Transition: '<S1>:2' */
num_iter = 1;
while (flag && (num_iter <= 100)) {
    /* Transition: '<S1>:3' */
    /* Transition: '<S1>:4' */
    /* Event: '<S1>:12' */
    func();
    num_iter = num_iter + 1;

    /* Transition: '<S1>:5' */
}

/* Transition: '<S1>:1' */
}

```

Modeling Pattern for While Loop: MATLAB Function Block

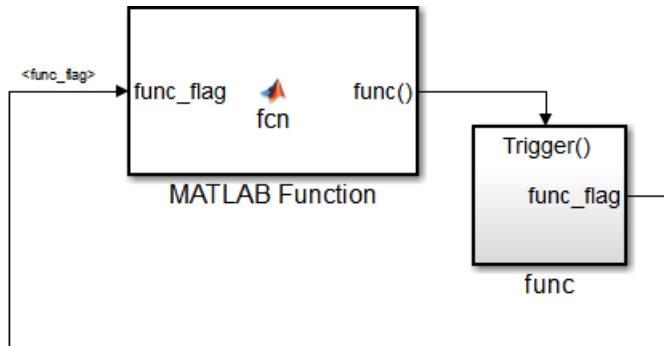

Model ex_while_loop_ML

Procedure

- 1 In the Simulink Library Browser, click **Simulink > User Defined Functions**, and drag a MATLAB Function block into your model.
- 2 Double-click the MATLAB Function block. The MATLAB Function Block Editor opens.

- 3 In the MATLAB Function Block Editor enter the function, as follows:

```
function fcn(func_flag)

flag = true;
num_iter = 1;

while(flag && (num_iter<=100))
    func;
    flag = func_flag;
    num_iter = num_iter + 1;
end
```

- 4 Click **Save** and close the MATLAB Function Block Editor.
- 5 Place a Subsystem block in your model, right-click the subsystem and select **Block Parameters (Subsystem)**. The Block Parameters dialog box opens.
- 6 Select the **Treat as atomic unit** parameter to configure the subsystem to generate a function. This enables parameters on the **Code Generation** tab.
- 7 Select the **Code Generation** tab. From the **Function packaging** list, select the option, **Nonreusable function**.
- 8 From the **Function name options** list, select the option, **User specified**. The **Function name** parameter is displayed.
- 9 Specify the name as **func**.
- 10 Click **Apply**.
- 11 Double-click the **func()** subsystem block. In this example, function **func()** has an output **flag** set to 0 or 1 depending on the result of the algorithm in **func()**. The Trigger block parameter **Trigger type** is **function-call**. Create the **func()** algorithm, as shown in the following diagram:

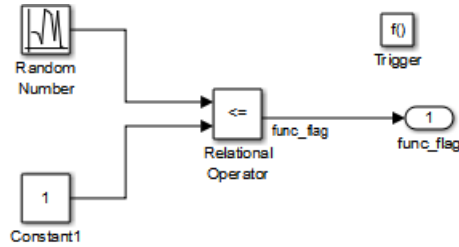

12 Save and close the subsystem.

13 Connect the MATLAB Function block to the func() subsystem.

14 Save your model.

Results

The generated code includes the following `while_loop_ML_step` function in the file `while_loop_EML.c`. In some cases an equivalent for loop might be generated instead of a while loop.

```

/* Exported block signals */
boolean_T func_flag;          /* '<S2>/Relational Operator' */

/* Block states (auto storage) */
D_Work DWork;

/* Model step function */
void while_loop_ML_step(void)
{
    boolean_T func_flag_0;
    boolean_T flag;
    int32_T num_iter;

    /* MATLAB Function Block: '<Root>/MATLAB Function Executes
     * the desired While-Loop' incorporates:
     * SubSystem: '<Root>/func()' updates the "flag"
     */
    func_flag_0 = func_flag;

    /* MATLAB Function 'MATLAB Function

```



```
    * Executes the desired While-Loop': '<S1>:1' */
/* '<S1>:1:3' */
flag = TRUE;

/* '<S1>:1:4' */
num_iter = 1;
while (flag && (num_iter <= 100);
    num_iter++) {
    /* '<S1>:1:6' */
    /* '<S1>:1:7' */
    func();

    /* '<S1>:1:8' */
    flag = func_flag_0;

    /* '<S1>:1:9' */
    num_iter++;
}
}
```

Do While Loop

C Construct

```
num_iter = 1;
do {
    flag = func();
    num_iter++;
}
while (flag && num_iter <= 100)
```

Modeling Patterns

- “Modeling Pattern for Do While Loop: While Iterator Subsystem block” on page 5-63
- “Modeling Pattern for Do While Loop: Stateflow Chart” on page 5-66

Modeling Pattern for Do While Loop: While Iterator Subsystem block

One method for creating a while loop is to use a While Iterator Subsystem block from the **Simulink > Ports and Subsystems** library.

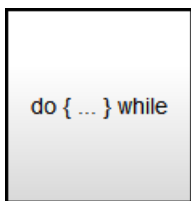

While Iterator
Subsystem

ex_do_while_loop_SL

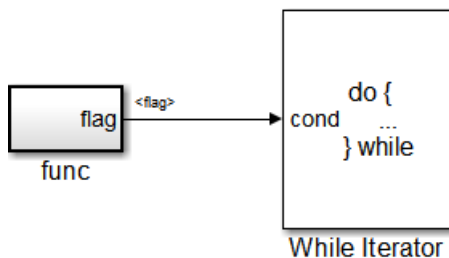

ex_do_while_loop_SL/While Iterator Subsystem

Procedure

- 1 Drag a While Iterator Subsystem block from the **Simulink > Ports and Subsystems** library into the model.
- 2 Double-click the While Iterator Subsystem block to open the subsystem.
- 3 Place a Subsystem block next to the While Iterator block.
- 4 Right-click the subsystem and select **Block Parameters (Subsystem)**. The Block Parameters dialog box opens.

- 5** Select the **Treat as atomic unit** parameter to configure the subsystem to generate a function. This enables parameters on the **Code Generation** tab.
- 6** Select the **Code Generation** tab. From the **Function packaging** list, select the option, Nonreusable function.
- 7** From the **Function name options** list, select the option, User specified. The **Function name** parameter is displayed.
- 8** Specify the name as func.
- 9** Click **Apply**.
- 10** Double-click the func subsystem block. In this example, function func has an output flag set to 0 or 1 depending on the result of the algorithm in func. Create the func algorithm as shown in the following diagram:

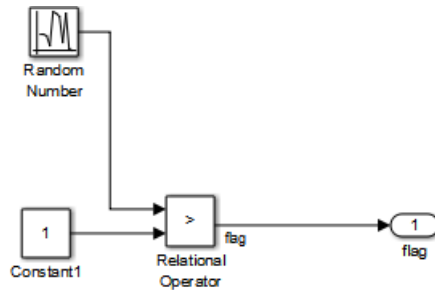

ex_do_while_loop_SL/While Iterator Subsystem/func

- 11** Double-click the While Iterator block. This opens the Block Parameters dialog.
- 12** Set the **Maximum number of iterations** to 100.
- 13** Specify the **While loop type** as do-while.
- 14** Connect blocks as shown in the model and subsystem diagrams.
- 15** Enter Ctrl+B to generate code.

Results

```
void func(void)
{
    flag = (DWork.NextOutput > (real_T)P.Constant1_Value);
    DWork.NextOutput =
        rt_NormalRand(&DWork.RandSeed) * P.RandomNumber_StdDev +
        P.RandomNumber_Mean;
}

void ex_do_while_loop_SL_step(void)
{
    int32_T s1_iter;

    s1_iter = 1;
    do {
        func();
        s1_iter++;
    } while (flag && (s1_iter <= 100));
}
```

Modeling Pattern for Do While Loop: Stateflow Chart

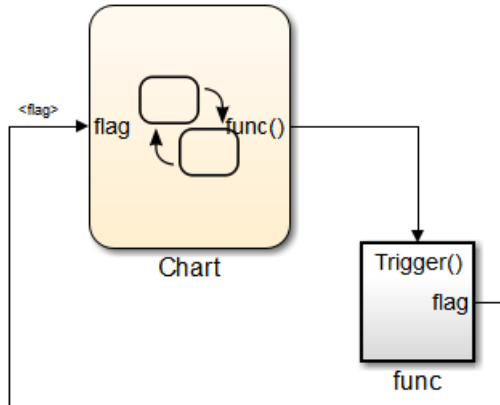

ex_do_while_loop_SF

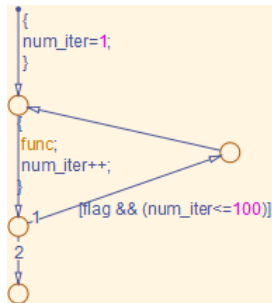

ex_do_while_loop_SF/Chart

- 1 Add a Stateflow Chart to your model from the **Stateflow > Chart** library.
- 2 Double-click the chart to open it.
- 3 Add the inputs and outputs to the chart and specify their data type.
- 4 Connect the data input and output to the Stateflow chart.
- 5 In the Model Explorer, select the output variable, then, in the right pane, select the **General** tab and set the **Initial Value** to 0.

6 Select **Chart > Add Patterns > Loop > While**. The Stateflow Pattern dialog opens.

7 Fill in the fields for the Stateflow Pattern dialog box as follows:

Description	While Loop (optional)
While condition	(flag) && (num_iter<=100)
Do action	func; num_iter++;

8 Place a Subsystem block in your model.

9 Right-click the subsystem and select **Block Parameters (Subsystem)**. The Block Parameters dialog box opens.

10 Select the **Treat as atomic unit** parameter to configure the subsystem to generate a function. This enables parameters on the **Code Generation** tab.

11 Select the **Code Generation** tab. From the **Function packaging** list, select the option, **Nonreusable function**.

12 From the **Function name options** list, select the option, **User specified**. The **Function name** parameter is displayed.

13 Specify the name as `func`.

14 Click **Apply** to apply the changes.

15 Double-click the `func` subsystem block. In this example, function `func` has an output `flag` set to 0 or 1 depending on the result of the algorithm in `func`. The Trigger block parameter **Trigger type** is **function-call**. Create the `func` algorithm, as shown in the following diagram:

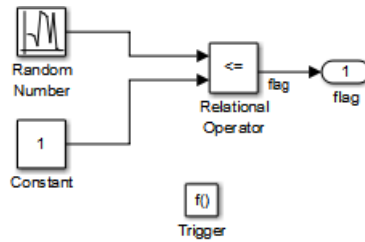

ex_do_while_loop_SF/func Updates the flag

- 16** Save and close the subsystem.
- 17** Connect blocks to the Stateflow chart as shown in the model diagram for ex_do_while_loop_SF.
- 18** Save your model.

Results

```
void ex_do_while_loop_SF_step(void)
{
    int32_T sf_num_iter;
    num_iter = 1;
    do {
        func();
        num_iter++;
    } while (flag && (sf_num_iter <= 100));
}
```

Function Call

To generate a function call, add a subsystem, which implements the operations that you want.

C Construct

```
void add_function(void)
{
    y1 = u1 + u2;
}
```

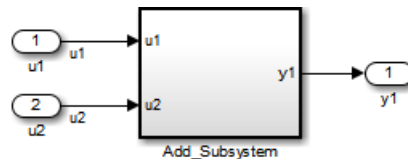

ex_function_call

Procedure

- 1 Create a model containing a subsystem. In this example, the subsystem has two inputs and returns one output.
- 2 Double-click the subsystem. Create `Add_Subsystem`, as shown.

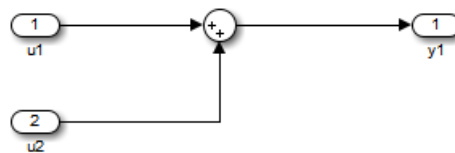

ex_function_call/Add_Subsystem

- 3 Right-click the subsystem and select **Block Parameters (Subsystem)** to open the Subsystem Parameters dialog box.
- 4 Select the **Treat as atomic unit** parameter. This enables parameters on the **Code Generation** tab.

Select the **Code Generation** tab. For the **Function packaging** parameter, from the drop-down list, select `Nonreusable function`.

5 For the **Function name options** parameter, from the drop-down list, select `User specified`.

6 In the **Function name** field, enter the subsystem name, `add_function`.

7 Click **Apply** and **OK**.

8 Press **Ctrl+B** to build and generate code.

Results

In `ex_function_call.c`, the function is called from `ex_function_call_step`:

```
void ex_function_call_step(void)
{
    add_function();
}
```

The function prototype is externed through the subsystem file, `add_function.h`.

```
extern void add_function(void);
```

The function definition is in the subsystem file `add_function.c`:

```
void add_function(void)
{
    function_call_Y.y1 = u1 + u2;
}
```

Function Prototyping

C Construct

```
double add_function(double u1, double u2)
{
    return u1 + u2;
}
```

Modeling Patterns

- “Function Call Using Graphical Functions” on page 5-71
- “Control Function Prototype of the *model_step* Function” on page 5-73

Function Call Using Graphical Functions

Procedure

- 1 Follow the steps for “Set Up an Example Model With a Stateflow Chart” on page 5-6. This example model contains two Inport blocks and one Outport block.
- 2 Name the example model `ex_func_SF`.
- 3

In the **Stateflow Editor**, create a graphical function by clicking the *fx* button and placing a graphical function into the Stateflow chart.
- 4 Edit the graphical function signature to: `output = add_function(u1, u2)`.
- 5 Add the transition action, as shown in the following diagram.

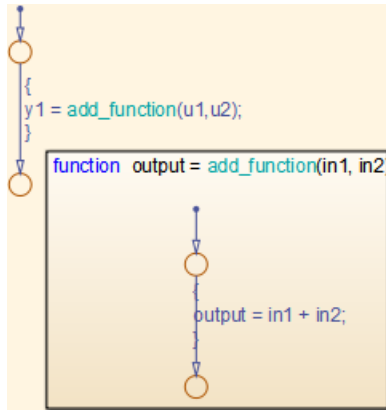

ex_func_SF/Chart

In the Stateflow chart is an example of a simple transition that calls `add_function`.

- 6 Open the Model Explorer. From the Model Hierarchy tree, select **ex_func_SF > Chart > f()add_function**. On the right pane, specify the **Function Inline Option** as **Function**.
- 7 From the Model Hierarchy tree, click **Chart** and on the right pane select the **Export Chart Level Functions (Make Global)** parameter. This makes the function available globally to the entire model.
- 8 Press **Ctrl+B** to build the model and generate code.

Results

`ex_func_SF.c` contains the generated code:

```
extern real_T add_function(real_T sf_in1, real_T sf_in2)
{
    return sf_in1 + sf_in2;
}
.
.
.
void ex_func_SF_step(void)
{
```

```

ex_func_SF_B.y1 = add_function(u1, u2);

ex_func_SF_Y.y1 = ex_func_SF_B.y1;
}

```

Control Function Prototype of the *model_step* Function

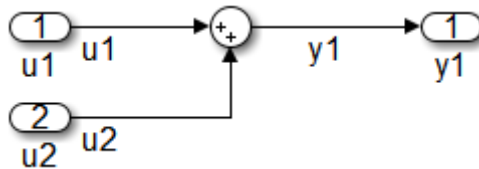

ex_control_step_function

Procedure

- 1** Create the model, `ex_control_step_function`. See “Configure a Signal” on page 5-4 and “Configure Input and Output Ports” on page 5-4, for more information.
- 2** Press **Ctrl+E** to open the Configuration Parameters dialog box.
- 3** On the **Code Generation > Interface** pane, click **Configure Model Functions** to open the Model Interface dialog box.
- 4** Specify the **Function specification** parameter as `Model specific C prototypes`.
- 5** Click **Get Default Configuration** to update the **Configure model initialize and step functions** section and list the input and output arguments.
- 6** To configure the function output argument to pass a pointer, in the **Step function arguments** table, specify the **Category** for the Output as a **Pointer**. In addition, you can specify the step function arguments order and type qualifiers.
- 7** To validate your changes, click **Validate**.

8 Press **Ctrl+B** to build the model and generate code.

Results

`ex_control_step_function.c` contains the generated code:

```
void ex_control_step_function_custom(real_T arg_u1, real_T arg_u2, ...
                                   real_T *arg_y1)
{
    (*arg_y1) = arg_u1 + arg_u2;
}
```

External C Functions

C Construct

```
extern double add(double, double);
```

```
#include "add.h"
double add(double u1, double u2)
{
    double y1;
    y1 = u1 + u2;
    return (y1);
}
```

Modeling Patterns

There are several methods for integrating legacy C functions into the generated code. These methods either create an S-function or make a call to an external C function. For more information on S-functions, see “Insert S-Function Code”.

- “Use the Legacy Code Tool to Create S-functions” on page 5-75
- “Use a Stateflow Chart to Make Calls to C Functions” on page 5-78
- “Using a MATLAB Function Block to Make Calls to C Functions” on page 5-79

Use the Legacy Code Tool to Create S-functions

This method uses the Legacy Code Tool to create an S-function and generate a TLC file. The code generation software uses the TLC file to generate code from this S-function. The advantage of using the Legacy Code Tool is that the generated code is fully inlined and does not need wrapper functions to access the custom code.

Procedure

- 1 Create a C header file named `add.h` that contains the function signature:

```
extern double add(double, double);
```

- 2 Create a C source file named `add.c` that contains the function body:

```
double add(double u1, double u2)
{
    double y1;
    y1 = u1 + u2;
    return (y1);
}
```

- 3 To build an S-function for use in both simulation and code generation, Run the following script or execute each of these commands at the MATLAB command line:

```
%% Initialize legacy code tool data structure
def = legacy_code('initialize');

%% Specify Source File
def.SourceFiles = {'add.c'};

%% Specify Header File
def.HeaderFiles = {'add.h'};

%% Specify the Name of the generated S-function
def.SFunctionName = 'add_function';

%% Create a c-mex file for S-function
legacy_code('sfcn_cmex_generate', def);

%% Define function signature and target the Output method
def.OutputFcnSpec = ['double y1 = add(double u1, double u2)'];

%% Compile/Mex and generate a block that can be used in simulation
legacy_code('generate_for_sim', def);

%% Create a TLC file for Code Generation
```



```
legacy_code('sfcn_tlc_generate', def);

%% Create a Masked S-function Block
legacy_code('slblock_generate', def);
```

The output of this script produces:

- A new model containing the S-function block
- A TLC file named `add_function.tlc`.
- A C source file named `add_function.c`.
- A mexw32 dll file named `add_function.mexw32`

- 4 Add inport blocks and an output block and make the connections, as shown in the model.

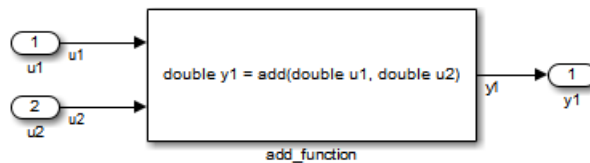

ex_function_call_lct

- 5 Name and save your model. In this example, the model is named `ex_function_call_lct`.
- 6 Press **Ctrl+B** to build the model and generate code.

Results

The following code is generated in `ex_function_call_lct.c`:

```
real_T u1;
real_T u2;
real_T y1;
void ex_function_call_lct_step(void)
{
    y1 = add(u1, u2);
}
```

The user-specified header file, `add.h`, is included in `ex_function_call_lct.h`:

```
#include "add.h"
```

Use a Stateflow Chart to Make Calls to C Functions

Procedure

- 1 Create a C header file named `add.h` that contains the example function signature.
- 2 Create a C source file named `add.c` that contains the function body.
- 3 Follow the steps for “Set Up an Example Model With a Stateflow Chart” on page 5-6. This example model contains two Inport blocks and one Outport block.
- 4 Name the example model `ex_exfunction_call_SF`.
- 5 Double-click the Stateflow chart and edit the chart as shown. Place the call to the `add` function within a transition action.

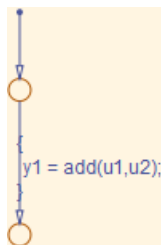

`ex_exfunction_call_SF/Chart`

- 6 On the **Stateflow Editor**, select **Simulation > Model Configuration Parameters**.
- 7 On the Configuration Parameters dialog box, select **Simulation Target > Custom Code**. In the **Include custom C code in generated** section, on the left pane, select **Header file** and in the **Header file** field, enter the `#include` statement:

```
#include "add.h"
```

8 In the **Include list of additional** section, select **Source files** and in the **Source files** field, enter `add.c`.

9 Press **Ctrl+B** to build the model and generate code.

Results

`ex_exfunction_call_SF.c` contains the following code in the step function:

```
real_T u1;
real_T u2;
real_T y1;

void exfunction_call_SF_step(void)
{
    y1 = (real_T)add(u1, u2);
}
```

`ex_exfunction_call_SF.h` contains the include statement for `add.h`:

```
#include "add.h"
```

Using a MATLAB Function Block to Make Calls to C Functions

Procedure

- 1** Create a C header file named `add.h` that contains the example function signature.
- 2** Create a C source file named `add.c` that contains the function body.
- 3** In the Simulink Library Browser, click **Simulink > User Defined Functions**, and drag a MATLAB Function block into your model.
- 4** Double-click the MATLAB Function block. The MATLAB Function Block Editor opens.
- 5** Edit the function to include the statement:

```
function y1 = add_function(u1, u2)
```

```
%Set the class and size of output
y1 = u1;

%Call external C function
y1 = coder.ceval('add',u1,u2);

end
```

6 Open the Configuration Parameters dialog box, and select **Simulation Target > Custom Code**.

7 In the **Include custom C code in generated** section, on the left pane, select **Header file** and in the **Header file** field, enter the statement, :

```
#include "add.h"
```

8 In the **Include list of additional** section, select **Source files** and in the **Source files** field, enter `add.c`.

9 Add two Inport blocks and one Outport block to the model and connect to the MATLAB Function block.

10 Configure the signals: `u1`, `u2`, and `y1`, as described in “Configure a Signal” on page 5-4.

11 Save the model as `ex_exfunction_call_ML`.

12 Press **Ctrl+B** to build the model and generate code.

Results

`ex_exfunction_call_ML.c` contains the following code:

```
real_T u1;
real_T u2;
real_T y1;

void ex_exfunction_call_ML_step(void)
{
    y1 = add(u1, u2);
}
```

`ex_exfunction_call_ML.h` contains the `#include` statement for `add.h`:

```
#include "add.h"
```

Macro Definitions (#define)

C Construct

```
#define p_1 9.8;
```

Modeling Patterns

“Use a ‘Define’ Custom Storage Class” on page 5-82

“Use a Custom Header File” on page 5-83

Use a ‘Define’ Custom Storage Class

Procedure

- 1 Create a model containing a Gain block.

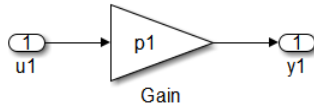

- 2 Press **Ctrl+E** to open the Configuration Parameters dialog box.
- 3 In the Configuration Parameter dialog box, on the **Optimization > Signals and Parameters** pane, select **Inline parameters**.
- 4 Click **Apply** and **OK**.
- 5 In your model, double-click the Gain block. The Block Parameters dialog box opens.
- 6 In the **Value** field, enter a variable name. In this example, the variable name is **p1**.
- 7 Press **Ctrl+H** to open the Model Explorer. On the Model Hierarchy pane, select the Base Workspace.

- 8** To add an MPT parameter object, in the menu bar, select **Add > MPT Parameter**. The parameter appears in the **Contents of: Base Workspace** pane.
- 9** Double-click the `mpt.Parameter` object and change its name to `p1`.
- 10** Click the `p1` parameter. The data object parameters are displayed in the right pane of the Model Explorer.
- 11** In the **Value** field, enter **9.8**. In the **Code generation options** section, click the **Storage Class** drop-down list and select **Define (Custom)**.
- 12** Press **Ctrl+B** to generate code.

Results

The generated code includes the inlined parameter, `p1`, in `ex_define_data_object.c`:

```
/* Model step function */
void ex_define_data_object_step(void)
{
    rtY.y1 = p1 * rtU.u1;
}

```

Use a Custom Header File

Procedure

- 1** Follow steps 1 through 10 of “Use a ‘Define’ Custom Storage Class” on page 5-82.
- 2** In the `Simulink.Parameter` dialog box for `p1`, in the **Value** field, enter **9.8**. In the **Code generation options** section, click the **Storage Class** drop-down list and select **ImportFromFile (Custom)**.
- 3** In the **Header file** parameter, enter the name of the header file, in this example, `external_params.h`.
- 4** Click **Apply** and **OK**.

- 5** Create the C header file, `external_params.h` that contains the `#define` statement:

```
#ifndef _EXTERNAL_PARAMS
#define _EXTERNAL_PARAMS

#define p1 9.8

#endif

/* EOF */
```

- 6** Press **Ctrl+B** to generate code.

Results

The generated code includes the inlined parameter, `p1`, in `ex_define_data_object.c`:

```
/* Model step function */
void ex_define_data_object_step(void)
{
    ex_define_data_object_Y.Out1 = p1 * ex_define_data_object_U.In1;
}
```

Conditional Inclusions (#if / #endif)

You can generate preprocessor conditional directives in your code by implementing variant blocks (Model Variants block or Variant Subsystem block) in your model. In the generated code, preprocessor conditional directives select a section of code to execute at compile time. To implement variants in your model, see “Working with Variant Systems”. To generate code for variants, see “Generate Preprocessor Conditionals for Variant Systems” on page 6-4.

Typedef

To generate a typedef definition, use a Simulink.AliasType data object.

C Construct

```
typedef double float_64;
```

Procedure

- 1 Create the ex_get_typedef model with a Gain block.

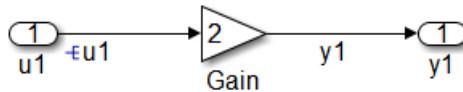

- 2 In the Gain block parameter dialog box, select the **Parameter Attributes** tab, and specify the **Parameter data type** as double.
- 3 Right-click the u1 signal and select **Properties**. In the Signal Properties dialog box, select **Signal name must resolve to Simulink signal object**.
- 4 Right-click the y1 signal and select **Properties**. In the Signal Properties dialog box, select the **Code Generation** tab, and specify the **Storage class** parameter as ExportedGlobal.
- 5 Create a new alias type by using a Simulink.AliasType data object. At the MATLAB command line, enter:

```
float_64 = Simulink.AliasType;
```
- 6 In the base workspace, double-click float_64. The Simulink.AliasType dialog box opens.
- 7 Specify the **Base type** parameter as double. Click **Apply** and **OK**.
- 8 Create a data object for the u1 signal. In the base workspace, select **Add > Simulink Signal**, and name it u1. Specify the **Data type** parameter as float_64 and the **Storage class** parameter as Global(custom).

Note You can also specify an output data type for Simulink blocks using the new alias type.

9 Click **Apply** and **OK**.

10 Press **Ctrl+B** to generate code.

Note An alternative method for defining a typedef is to import the alias type from a custom header file. If you want to import all of the typedefs from a C header file, using this alternative method is useful.

Results

The generated code includes the typedef definition, which is declared within #ifndef and #endif statements in the ex_get_typedef_types.h file.

```
#ifndef _DEFINED_TYPEDEF_FOR_float_64_
#define _DEFINED_TYPEDEF_FOR_float_64_

typedef real_T float_64;
typedef creal_T cfloat_64;

#endif
```

Note real_T is the Embedded Coder typedef for double .

The generated code also includes the declaration of the Simulink data objects of the alias type in ex_get_typedef.c.

```
float_64 y1;
float_64 u1;
```

Structures for Parameters

To generate a structure containing parameters, use a `mpt.Parameter` object with a `Struct (custom)` storage class.

C Construct

```
typedef struct {
    double p1;
    double p2;
    double p3;
} my_struct_type;

my_struct_type my_struct={1.0,2.0,3.0};
```

Procedure

- 1 Create the `ex_struct_param` model with three Constant blocks and three Output blocks.

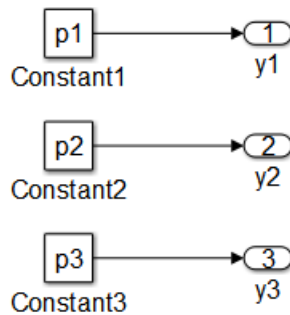

- 2 Create a data object for each parameter, `p1`, `p2`, and `p3`. At the MATLAB command line, enter:

```
p1 = mpt.Parameter;
p2 = mpt.Parameter;
p3 = mpt.Parameter;
```

- 3 In the base workspace, double-click one of the parameter data objects to open the `mpt.Parameter` dialog box.

- 4 Specify a **Value** parameter for each parameter object.
- 5 Specify the **Storage class** parameter as **Struct (Custom)** for each parameter object.
- 6 In the **Custom Attributes** section, specify the **Struct name** as `my_struct`. Click **Apply** and **OK**.
- 7 Press **Ctrl+E** to open the Configuration Parameters dialog box.
- 8 Open the **Optimization > Signals and Parameters** pane, and select the **Inline parameters** parameter.
- 9 Click **Apply** and **OK**.
- 10 Press **Ctrl+B** to generate code.

Results

The generated code includes the typedef definition for a structure, which is declared in the `ex_struct_param_types.h` file.

```
/* Type definition for custom storage class: Struct */
typedef struct my_struct_tag {
    real_T p1;
    real_T p2;
    real_T p3;
} my_struct_type;
```

The generated code also includes the declaration of `my_struct` in `ex_struct_param.c`.

```
/* Definition for custom storage class: Struct */
my_struct_type my_struct = {
    /* p1 */
    1.0,

    /* p2 */
    2.0,

    /* p3 */
    3.0
```

```
};
```

Structures for Signals

To generate a structure containing parameters, use a `mpt.Signal` object with a `Struct` (custom) storage class or a Simulink non-virtual bus object.

C Construct

```
typedef struct {
    double u1;
    double u2;
    double u3;
} my_signals;
```

Modeling Patterns

“Structure for Signals Using a ‘Struct’ Custom Storage Class” on page 5-91

“Structure for Signals Using a Simulink Non-Virtual Bus Object” on page 5-93

Structure for Signals Using a ‘Struct’ Custom Storage Class

Procedure

- 1 Create the `ex_signal_struct_csc` model using the blocks shown and follow the steps to configure the signals and model.

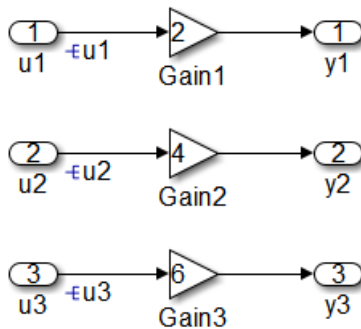

- 2** Double-click a Gain block to open the block parameter dialog box. Set the values of the Gain blocks as shown in the model diagram.
- 3** Right-click the u1 signal and select **Properties**. In the Signal Properties dialog box, select **Signal name must resolve to Simulink signal object**. Repeat for signals u2 and u3.
- 4** At the MATLAB command line, create a `mpt.Signal` data object for each input signal.

```
u1 = mpt.Signal;  
u2 = mpt.Signal;  
u3 = mpt.Signal;
```

Note You can also create a data object in the Model Explorer base workspace, by selecting **Add > MPT Signal**.

- 5** In the base workspace, configure each of the data objects, u1, u2, and u3. Double-click a data object, to open the `mpt.Signal` parameter dialog box.
- 6** Specify the **Data type** parameter as `auto` and the **Storage class** parameter as `Struct (custom)`.
- 7** Click **Apply** and **OK**.
- 8** Press **Ctrl+B** to generate code.

Results

The generated code includes the `typedef` definition for a structure, which is declared in the `ex_signal_struct_csc_types.h` file.

```
/* Type definition for custom storage class: Struct */  
typedef struct my_signal_struct_tag {  
    real_T u1;  
    real_T u2;  
    real_T u3;  
} my_signal_struct_type;
```



The generated code also includes the declaration of `my_signal_struct` in `ex_signal_struct_csc.c`.

```
/* Definition for custom storage class: Struct */
my_signal_struct_type my_signals;
```

Structure for Signals Using a Simulink Non-Virtual Bus Object

Procedure

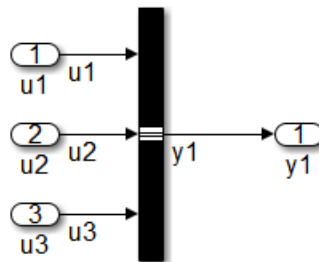
- 1 Create the `ex_signal_struct_bus` model using the blocks shown and follow the steps to configure the bus object and model.



This block creates a bus signal from its inputs.

- 2 Add the Inport blocks, an Output block, and a Bus Creator block to your diagram.
- 3 Double-click the Bus Creator block to open the block parameter dialog box.
- 4 Specify the **Number of inputs** parameter as 3. Click **Apply**.
- 5 In your model diagram, connect the three Inport blocks to the three inports of the Bus Creator block. Also, connect the output of the Bus Creator block to the Output block.
- 6 Label the signals as shown in the model diagram.
- 7 In the Bus Creator block parameter dialog box, **Signals in bus** now displays the signals connected to the Bus Creator block.

- 8 Create a bus object named `MySignals` that includes signals `u1`, `u2`, and `u3`. For more information on creating bus objects, see “Manage Bus Objects with the Bus Editor”. Once the bus object, `MySignals`, is created, it appears in the base workspace.
- 9 In the Bus Creator block parameter dialog box, select the **Output as nonvirtual bus** parameter, which specifies that bus signals must be grouped into a structure in the generated code.
- 10 Click **Apply** and **OK**.
- 11 Press **Ctrl+B** to generate code.

Results

The generated code includes the `typedef` definition for a structure, which is declared in the `signal_struct_bus_types.h` file.

```
typedef struct {  
    real_T u1;  
    real_T u2;  
    real_T u3;  
} MySignals;
```

Nested Structures

One way to create nested structures of signals in the generated code is by using multiple non-virtual bus objects. When nesting bus objects, all of the bus objects must either be non-virtual, or all of them must be virtual.

C Construct

```
typedef struct {  
    double u1;  
    double u2;  
    double u3;  
} my_signals123;
```

```
typedef struct {  
    double u4;  
    double u5;  
    double u6;  
} my_signals456;
```

```
typedef struct {  
    my_signals123 y1;  
    my_signals456 y2;  
} nested_signals;
```

Procedure

- 1 Create the `ex_nested_structure` model using the blocks shown and follow the steps to configure the bus objects and model.

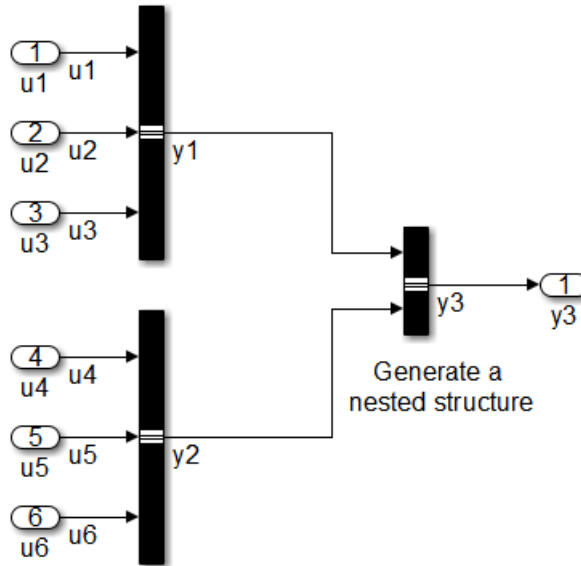

- 2 For each bus in the model, follow the instructions for “Structure for Signals Using a Simulink Non-Virtual Bus Object” on page 5-93, creating bus objects My_Signals_123 and My_Signals_456.
- 3 Drag a Bus Creator block into your model. Configure the Bus Creator block so that it takes in signals from different buses.
- 4 Double-click the Bus Creator block to open the block parameter dialog box.
- 5 Specify the **Number of inputs** parameter as 2. Click **Apply**.
- 6 In your model diagram, connect the two bus outputs to the inports of the new Bus Creator block.
- 7 Label the signals as shown in the model diagram.
- 8 In the Bus Creator block parameter dialog box, **Signals in bus** now displays the signals, y1 and y2, connected to the Bus Creator block.
- 9 Create a bus object named Nested_Signals that includes signals y1 and y2, where the **Data Type** for y1 is My_Signals_123 and the **Data Type** for y2 is My_Signals_456.

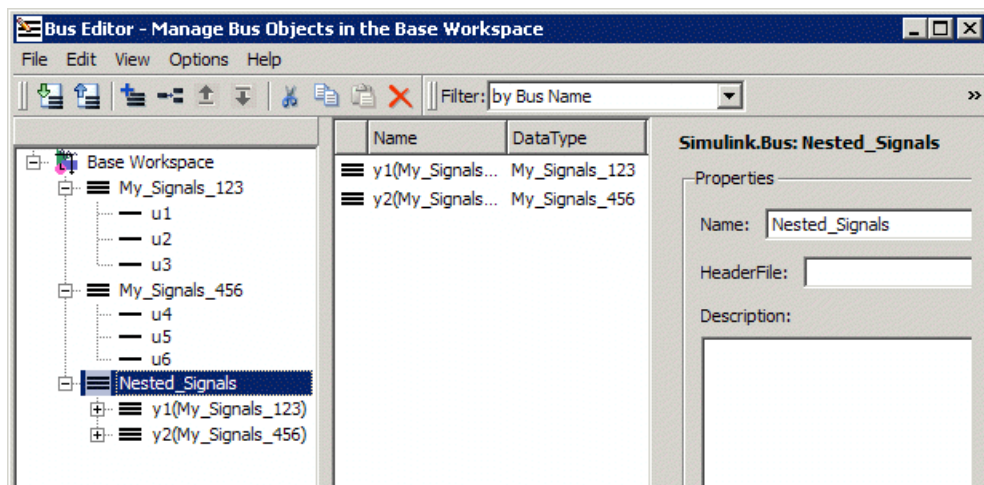

For more information on creating bus objects, see “Manage Bus Objects with the Bus Editor”. Once the bus object, `Nested_Signals`, is created, it appears in the base workspace.

10 In the Bus Creator block parameter dialog box, select the **Output as nonvirtual bus** parameter, which specifies that bus signals must be grouped into a structure in the generated code.

11 Click **Apply** and **OK**.

12 Press **Ctrl+B** to generate code.

Results

The generated code includes the `typedef` definitions for structures, which are declared in the `ex_nested_structure_types.h` file.

```
#ifndef _DEFINED_TYPEDEF_FOR_My_Signals_123_
#define _DEFINED_TYPEDEF_FOR_My_Signals_123_

typedef struct {
    real_T u1;
    real_T u2;
    real_T u3;
} My_Signals_123;
```

```
#endif

#ifndef _DEFINED_TYPEDEF_FOR_My_Signals_456_
#define _DEFINED_TYPEDEF_FOR_My_Signals_456_

typedef struct {
    real_T u4;
    real_T u5;
    real_T u6;
} My_Signals_456;

#endif

#ifndef _DEFINED_TYPEDEF_FOR_Nested_Signals_
#define _DEFINED_TYPEDEF_FOR_Nested_Signals_

typedef struct {
    My_Signals_123 y1;
    My_Signals_456 y2;
} Nested_Signals;

#endif
```

Bitfields

One way to create bitfields in the generated code is by using a `mpt.Parameter` object with `Bitfield (Custom)` storage class.

C Construct

```
typedef struct {  
    unsigned int p1 : 1;  
    unsigned int p2 : 2;  
    unsigned int p3 : 3;  
} my_struct_type
```

Procedure

- 1 Using the model, `ex_struct_param`, in “Structures for Parameters” on page 5-88, rename the model as `ex_struct_bitfield_CSC`.
- 2 Create a data object for each parameter, `p1`, `p2`, and `p3`. At the MATLAB command line, enter:

```
p1 = mpt.Parameter;  
p2 = mpt.Parameter;  
p3 = mpt.Parameter;
```
- 3 In the base workspace, double-click one of the parameter data objects to open the `mpt.Parameter` dialog box.
- 4 Specify the **Value** parameter for each parameter object.
- 5 Specify the **Storage class** parameter as `Bitfield (Custom)` for each parameter object.
- 6 In the **Custom Attributes** section, specify the **Struct name** as `my_struct`. Click **Apply** and **OK**.
- 7 Specify the data objects for each parameter.

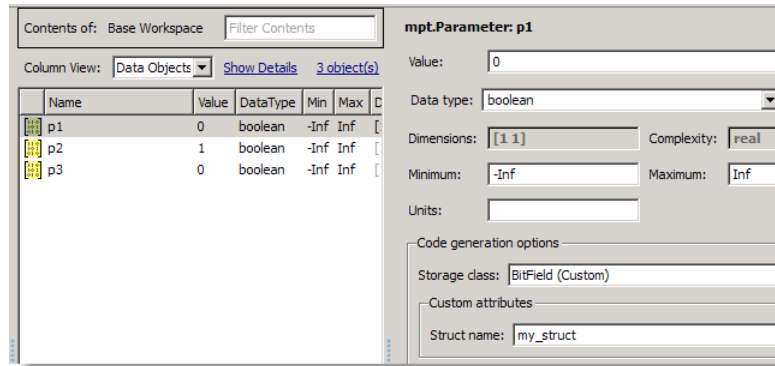

- 8** Press **Ctrl+E** to open the Configuration Parameters dialog box.
- 9** Open the **Optimization > Signals and Parameters** pane, and select the **Inline parameters** parameter.
- 10** Click **Apply** and **OK**.
- 11** Press **Ctrl+B** to generate code.

Results

The generated code of the model, `ex_struct_bitfield_CSC`, includes the `typedef` definition for a Bitfield, which is declared in the `ex_struct_bitfield_CSC_types.h` file.

```
/* Type definition for custom storage class: BitField */
typedef struct my_struct_tag {
    uint_T p1 : 1;
    uint_T p2 : 1;
    uint_T p3 : 1;
} my_struct_type;
```

Arrays for Parameters

To create an array in the generated code, you can use a constant parameter in the base workspace, or a `mpt.Parameter`.

C Construct

```
int params[5]= {1,2,3,4,5};
```

Procedure

- 1 Create a model, `ex_array_params`, containing the Constant blocks and Outport blocks and label the blocks as shown in the model diagram.

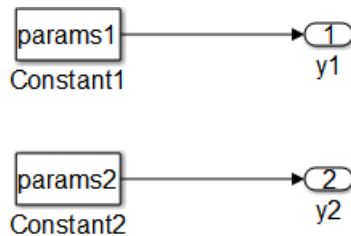

- 2 Double-click the Constant1 block and give the **Constant value** the name of a parameter, `params1`.
- 3 Double-click the Constant2 block and give the **Constant value** the name of a parameter, `params2`.
- 4 To create the parameters in the base workspace, at the MATLAB command line, enter:

```
params1 = [1,2,3,4,5];
params2 = mpt.Parameter;
```

- 5 In the base workspace, double-click `params2` to open the `mpt.Parameter` dialog box.
- 6 In the **Value** field, specify the array, `[1 2 3 4 5]`.
- 7 Press **Ctrl+E** to open the Configuration Parameters dialog box.

8 Open the **Optimization > Signals and Parameters** pane, and select the **Inline parameters** parameter.

9 Click **Apply** and **OK**.

10 Press **Ctrl+B** to generate code.

Results

The generated code includes the array, `params2`, in the `ex_array_params.c` file:

```
int16_T params2[5] = { 1, 2, 3, 4, 5 } ;
```

The data object, `params1`, is defined in the `array_params_data.c` file:

```
/* Constant parameters (auto storage) */
const ConstParam_array_params array_params_ConstP = {
    /* Computed Parameter: Constant1_Value
     * Referenced by: '/Constant1'
     */
    { 1, 2, 3, 4, 5 }
};
```

where `ConstParam_array_params` is a structure containing the array and defined in the `array_params.h` file.

```
typedef struct {
    /* Computed Parameter: Constant1_Value
     * Referenced by: '/Constant1'
     */
    int16_T Constant1_Value[5];
} ConstParam_array_params;
```

Arrays for Signals

To create an array in the generated code for signal data, you can specify a signal as `ExportedGlobal`, or use a `mpt.Signal` object.

C Construct

```
int u1[5];
int y1[5];
```

Procedure

- 1 Create the `ex_array_signals` model using the blocks shown and follow the steps to configure the signals and model.



- 2 Double-click the Inport block to open the Inport block parameter dialog box.
- 3 Select the **Signal Attributes** tab and specify the **Port dimensions** parameter as 5, for an array of length 5.
- 4 Click **OK**.
- 5 Right-click the `u1` signal line and select **Properties**.
- 6 Select the **Code Generation** tab and specify the **Storage Class** parameter as `ExportedGlobal`.
- 7 Repeat steps 5 and 6 for signal `y1`.
- 8 Press **Ctrl+B** to generate code.

Note Alternatively, you can use Simulink data objects (`mpt.Signal`) to specify the storage class and dimensions for the signals, `u1` and `y1`.

Results

The generated code includes arrays for `u1` and `y1` in the `ex_array_signals.c` file:

```
int16_T u1[5];  
int16_T y1[5];
```

In this case, a `for` loop is generated to carry out the gain operations on elements of the input signal.

```
int32_T i;  
for (i = 0; i < 5; i++) {  
    y1[i] = (int16_T)(5 * u1[i]);  
}
```

However, if the dimension of the array is less than a threshold value (typically 5), code generation might not include a `for` loop for array operations.

Pointers for Signals

To create a pointer in the generated code, you can configure a signal to use the `ImportedExternPointer` storage class or use an `mpt.Signal` (or `mpt.Parameter` for parameters) object with an `ImportedExternPointer` storage class.

C Construct

```
extern double *u1;
```

Procedure

This is a quick method to obtain pointers in the generated code. You cannot control the data type, which is decided by the model compilation process.

- 1 Create the `ex_pointer_signal` model using the blocks shown and follow the steps to configure the signals and model.

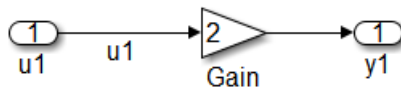

- 2 Label the signal to be imported as a pointer, in this example, `u1`.
- 3 Right-click the `u1` signal line and select **Properties**.
- 4 Select the **Code Generation** tab and specify the **Storage Class** parameter as `ImportedExternPointer`.
- 5 Click **OK**.
- 6 Press **Ctrl+B** to generate code.

Results

The generated code includes the `extern` declaration for the pointer in the `ex_pointer_signal_private.h` file.

```
extern real_T *u1;
```

Pointers Using Simulink Data Objects

You can control the data type of a signal or parameter by using a Simulink data object to generate a pointer.

C Construct

```
extern double *u1;
```

Procedure

You can use this procedure for either a signal or parameter. To create a pointer for a parameter, use an `mpt.Parameter` instead of an `mpt.Signal` data object described in step 3.

- 1 Create the `ex_pointer_signal_data_object` model using the blocks shown and follow the steps to configure the signals and model.

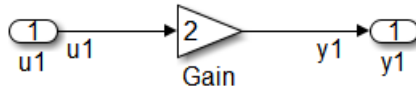

- 2 Label the signal to be imported as a pointer, in this example, `u1`.
- 3 At the MATLAB command line, create a data object for signal `u1`.

```
u1 = mpt.Signal;
```
- 4 In the base workspace, double-click `u1` to open the `mpt.Signal` dialog box.
- 5 Specify the **Storage class** parameter as `ImportedExternPointer`.
- 6 Click **Apply** and **OK**.
- 7 Press **Ctrl+B** to generate code.

Results

The generated code includes the `extern` declaration for the pointer in the `ex_pointer_signal_data_object_private.h` file.

```
extern real_T *u1;
```

The `ex_pointer_signal_data_object_private.h` file imports the pointer into the generated code. To compile the code, you must declare and define the pointer in the main program.

Variant Systems

- “About Variant Systems” on page 6-2
- “Why Generate Code for Variant Systems?” on page 6-3
- “Generate Preprocessor Conditionals for Variant Systems” on page 6-4
- “Review Code Variants in Code Generation Report” on page 6-7
- “Generate Code for Model Variants” on page 6-8
- “Generate Code for Variant Subsystems” on page 6-10
- “Restrictions on Variant Subsystem Code Generation” on page 6-14
- “Special Considerations for Generating Preprocessor Conditionals” on page 6-16
- “Limitations on Generating Code for Variants” on page 6-17
- “Generated Code Components Not Compiled Conditionally” on page 6-18

About Variant Systems

The Embedded Coder software generates code from a Simulink model containing one or more Model Variants blocks or Variant Subsystem blocks. To learn how to create a model containing variant blocks, see “Variant Systems”.

By default, the Simulink Coder software generates code for the active variant. The Embedded Coder software can generate code for different variant choices as well as the active variant. If you want to generate code for variants, you must set the following conditions:

- Select **Generate preprocessor conditionals**.
- Deselect **Override variant conditions and use the following variant**.
- Select **Model Configuration Parameters > Optimization > Signals and Parameters > Inline Parameters** .

Code generated for variants is surrounded by C preprocessor conditionals, `#if`, `#elif`, and `#endif`. Therefore, the active variant is selected at compile time and the preprocessor conditionals determine which sections of the code to execute.

To construct model reference variants and generate preprocessor directives in the generated code, see the example `rtwdemo_preprocessor_script`.

To construct variant subsystems and generate preprocessor directives in the generated code, see the example `rtwdemo_preprocessor_subsys_script`.

Why Generate Code for Variant Systems?

When you implement variants in the generated code, you can:

- Reuse generated code from a set of application models that share functionality with minor variations.
- Share generated code with a third party that activates one of the variants in the code.
- Validate the supported variants for a model and then choose to activate one variant for a particular application, without regenerating and re-validate the code.

Generate Preprocessor Conditionals for Variant Systems

Define Variant Controls

To learn about variant controls, see “How Variant Controls Work” in the Simulink documentation. Perform the following steps to define variant control for generating code.

- 1 Open the Model Explorer and click the **Base Workspace**.
- 2 A variant control can be a condition expression, a `Simulink.Variant` object specifying a condition expression or a `Simulink.Parameter` object. In the Model Explorer, select **Add** and choose **Simulink Parameter**. Specify a name for the new parameter.
- 3 On the `Simulink.Parameter` property dialog box, specify the **Value** and **Data type**.
- 4 Specify the **Storage class** parameter by choosing one of the following:
 - `ImportedDefine(Custom)` custom storage class.
 - `CompilerFlag(Custom)` custom storage class.
 - A user-defined storage class is created using the Custom Storage Class Designer. Your storage class must have the **Data initialization** parameter set to `Macro` and the **Data scope** parameter set to `Imported`. See “Use Custom Storage Class Designer” on page 10-8 for more information.
- 5 Specify the value of the variant control. If the storage class is either `ImportedDefine(Custom)` or a user-defined custom storage class, do the following:
 - a Specify the **Header File** parameter as an external header file in the Custom Attributes section of the `Simulink.Parameter` property dialog box.
 - b Supply the values of the variant controls in the external header file.

Note The generated code refers to a variant control as a user-defined macro. The generated code does not contain the value of the macro. The value of the variant control determines the active variant in the compiled code.

If the variant control is a `CompilerFlag` custom storage class the value of the variant control is set at compile time. On the **Code Generation > General** pane of the **Model Configuration Parameters** dialog box, add a makefile option to the “Make command” parameter. For example, for variant control, `VSSMODE`, enter `make_rtw OPTS=" -DVSSMODE=1 "` in the **Make command** field.

Note If you want to modify the value of the variant control after generating the makefile, use a makefile option when compiling your code. For example, at a command line outside of MATLAB, enter:

```
makecommand -f model.mk OPTS=" -DVSSMODE=1 "
```

- 6 Follow the instructions for to implement variant objects for code generation. Check that only one variant object is active in the generated code by implementing the condition expressions of the variant objects such that only one evaluates to `true`. The generated code includes a test of the variant objects to determine that there is only one active variant. If this test fails, your code will not compile.

Note You can define the variant controls using `Simulink.Parameter` object of enumerated type. This provides meaningful names and improves the readability of the conditions. The generated code includes preprocessor conditionals to check that the variant condition contains valid values of the enumerated type.

Configure Model for Generating Preprocessor Conditional Directives

In order to generate preprocessor conditional directives configure your model as follows:

- 1** On the **Code Generation** pane of the Configuration Parameter dialog box, set the **System target file** field as `ert.tlc`.
- 2** On the **Code Generation** pane of the Configuration Parameter dialog box, select the **Create code generation report** field.
- 3** On the **Optimization > Signals and Parameters** pane of the Configuration Parameters dialog box, select **Inline parameters**.
- 4** On the **Code Generation** pane of the Configuration Parameter dialog box, clear “Ignore custom storage classes”. In order to generate preprocessor conditionals, you must use custom storage classes.
- 5** On the **Interface** pane of the Configuration Parameter dialog box, select the **Use Local Settings** option of the **Generate preprocessor conditionals** parameter. This parameter is a global setting for the parent model. This setting enables the **Generate preprocessor conditionals** parameter located in the Model Variants block parameters dialog box or Variant Subsystem parameters dialog box. See “Generate preprocessor conditionals” for more information.
- 6** Open the Model Variants block parameters dialog box or the Variant Subsystem block parameter dialog box, depending on your application. Select the **Generate preprocessor conditionals** parameter. If the block parameters dialog box was already open, close and reopen the dialog box to see the enabled **Generate preprocessor conditionals** parameter.
- 7** Clear the parameter, **Override variant conditions and use following variant**.

Build Your Model

After configuring your model to generate code, build your model.

Review Code Variants in Code Generation Report

The Code Variants Report displays a list of the variant objects in alphabetical order and their condition. The report also lists the model blocks that have Variants, and the referenced models that use them. In the **Contents** section of the code generation report, click the link to the Code Variants Report:

Code Variants Report for rtwdemo_preprocessor

Table of Contents

- [Variant Control](#)
- [Model Reference Blocks that have Variants](#)
- [Subsystem Blocks that have Variants](#)

Variant Control [\[hide\]](#)

Variant	Condition	Used in Blocks
LINEAR	VSSMODE == 0	<Root>/Left Controller <Root>/Right Controller
NONLINEAR	VSSMODE == 1	<Root>/Left Controller <Root>/Right Controller

Model Reference Blocks that have Variants [\[hide\]](#)

Model Block	Variant	Model
<Root>/Left Controller	LINEAR	rtwdemo_linl
	NONLINEAR	rtwdemo_nlinl
<Root>/Right Controller	LINEAR	rtwdemo_linr
	NONLINEAR	rtwdemo_nlinr

Subsystem Blocks that have Variants [\[hide\]](#)

(No SubSystem blocks that have Variants)

Generate Code for Model Variants

To open a model for generating preprocessor conditionals, enter `rtwdemo_preprocessor`.

After building the model, look at the variants in the generated code. `rtwdemo_preprocessor_types.h` includes the following:

- Call to external header file, `rtwdemo_preprocessor_macros.h`, which contains the macro definition for the variant control variable, `VSSMODE`.

```
/* Includes for objects with custom storage classes. */
#include "rtwdemo_importedmacros.h"
```

- Preprocessor directives defining the variant objects, `LINEAR` and `NONLINEAR`. The values of these macros depend on the value of the variant control variable, `VSSMODE`. The condition expression associated with each macro, `LINEAR` and `NONLINEAR`, determine the active variant.

```
/* Model Code Variants */
#ifndef LINEAR
#define LINEAR (VSSMODE == 0)
#endif

#ifndef NONLINEAR
#define NONLINEAR (VSSMODE == 1)
#endif
```

- Check that exactly one variant is active at a time:

```
/* Exactly one variant for '<Root>/Left Controller' should be active */
#if (LINEAR) + (NONLINEAR) != 1
#error Exactly one variant for '<Root>/Left Controller' should be active
#endif
```

Calls to the step and initialization functions are conditionally compiled as shown in a portion of the step function, `rtwdemo_preprocessor_step`:

```
#if LINEAR

/* ModelReference: '<Root>/Left Controller' */
```



```
rtwdemo_linl(&rtb_Add, &rtb_LeftController_vmerge_1,
            &(rtwdemo_preprocessor_DWork.LeftController_1_DWORK1.rtdw));

#elif NONLINEAR

/* ModelReference: '<Root>/Left Controller' */
rtwdemo_nlinl(&rtb_Add, &rtb_LeftController_vmerge_1,
            &(rtwdemo_preprocessor_DWork.LeftController_2_DWORK1.rtdw));

#endif

and

#if LINEAR

/* ModelReference: '<Root>/Right Controller' */
rtwdemo_linr(&trb_Add, &rtb_RightController_vmerge,
            &(rtwdemo_preprocessor_DWork.RightController_1_DWORK1.rtdw));

#elif NONLINEAR

/* ModelReference: '<Root>/Right Controller' */
rtwdemo_nlinr(&rtb_Add, &rtb_RightController_vmerge_1,
            &(rtwdemo_preprocessor_DWork.RightController_2_DWORK1.rtdw));

#endif

/* LINEAR */
```

Generate Code for Variant Subsystems

Open the Example Model

Open model `AutoSSVar`, which contains a variant subsystem.

Define the Variant Controls

Variant Controls can be a condition expression or `Simulink.Variant` object specifying a condition expression or a `Simulink.Parameter` object. To recreate the variant controls specifically for code generation:

- 1 Open the Model Explorer and click the **Base Workspace**.
- 2 In the Model Explorer, remove the current variant control variables, `EMIS` and `FUEL`, and recreate them as `Simulink.Parameter` objects. Select **Add** and **Simulink Parameter** to create two variant control variables, `EMIS` and `FUEL`.
- 3 In the `Simulink.Parameter` property dialog box, specify the **Value** as 1 and the **Data type** as `int8` for both `EMIS` and `FUEL`.
- 4 Specify the **Storage class** parameter for both `EMIS` and `FUEL` as `ImportedDefine(Custom)`.
- 5 Specify the **Header File** parameter as an external header file, `AutoSSVar_variables.h`, in the **Custom Attributes** section of the `Simulink.Parameter` property dialog box. You must specify the header file since the storage class is `ImportedDefine(Custom)`.
- 6 Add the values of the variant control variables in the external header file `AutoSSVar_variables.h` as follows:

```
#define FUEL 1
#define EMIS 1
```

Note The generated code refers to a variant control variable as a user-defined macro. The generated code does not contain the value of the macro. The value of the variant control variable determines the active variant in the compiled code.

- 7 Check that only one variant is active in the generated code by implementing the condition expressions of the variant controls such that only one evaluates to `true`. The generated code includes a test of the variant controls to determine that there is only one active variant. If this test fails, your code does not compile.

Make Each Child Subsystem an Atomic Subsystem

- 1 Double-click the Variant Subsystem block, `Engine`, to display the child subsystems.
- 2 For each child subsystem, right-click the subsystem and select **Subsystem Parameters** from the list. The block parameters dialog box opens.
- 3 To specify each child subsystem as an atomic subsystem, in the block parameters dialog box, select the **Treat as atomic unit** parameter.

Configure Model for Generating Preprocessor Conditional Directives

In order to generate preprocessor conditional directives configure your model as follows:

- 1 On the **Code Generation** pane of the **Configuration Parameter** dialog box, specify the **System target file** parameter as `ert.tlc` and clear “Ignore custom storage classes”. In order to generate preprocessor conditionals, you must use custom storage classes.
- 2 On the **Optimization > Signals and Parameters**MATLAB pane of the **Configuration Parameters** dialog box, select **Inline parameters**.

- 3 On the **Code Generation > Interface** pane of the **Configuration Parameter** dialog box, select the **Enable All** option of the **Generate preprocessor conditionals** parameter. This parameter is a global setting for the parent model and enables generating preprocessor conditionals for variants in the model. For more information, see “Generate preprocessor conditionals”.
- 4 On the **Code Generation > Report** pane of the **Configuration Parameter** dialog box, select **Create code generation report**.

View the Generated Code

The generated code contains child subsystems of the Variant Subsystem block protected by C preprocessor conditionals. In this case, the selection of the active variant (subsystem) is deferred until the generated code is compiled. Only one variant object, which is encoded in C macros, must evaluate to true.

After building the model, look at the variants in the generated code. `AutoSSVar_types.h` includes the following:

- Call to external header file, `AutoSSVar_variables.h`, which contains the macro definitions for the variant control variables, `FUEL` and `EMIS`.

```
/* Includes for objects with custom storage classes. */  
#include "AutoSSVar_variables.h"
```

- Preprocessor directives defining the variant objects. The values of these macros depend on the value of the variant control variables, `FUEL` and `EMIS`. The condition expression associated with each macro determine the active variant.

```
/* Model Code Variants */  
#ifndef DE  
#define DE ((FUEL == 2) && (EMIS == 2))  
#endif  
  
#ifndef DU  
#define DU ((FUEL == 2) && (EMIS == 1))  
#endif  
  
#ifndef GE
```

```

#define GE                                ((FUEL == 1) && (EMIS == 2))
#endif

#ifndef GU
#define GU                                ((FUEL == 1) && (EMIS == 1))
#endif

```

- Check that exactly one variant is active at a time:

```

/* Exactly one variant for '<Root>/Engine' should be active */
#if (GU) + (GE) + (DU) + (DE) != 1
#error Exactly one variant for '<Root>/Engine' should be active
#endif

```

Calls to the step and initialization functions are conditionally compiled as shown in a portion of the step function, `AutoSSVar_step`, in `AutoSSVar.c`:

```

#if DE

    rtb_VariantMergeForOutportOut1 = 2.2 * AutoSSVar_U.In1;

#elif DU

    rtb_VariantMergeForOutportOut1 = 2.1 * AutoSSVar_U.In1;

#elif GE

    rtb_VariantMergeForOutportOut1 = 1.2 * AutoSSVar_U.In1;

#elif GU

    rtb_VariantMergeForOutportOut1 = 1.1 * AutoSSVar_U.In1;

#endif                                /* DE */

```

Restrictions on Variant Subsystem Code Generation

To generate preprocessor conditionals, the types of blocks that you can place within the child subsystems of a Variant Subsystem block are limited. Connections are not allowed in the Variant Subsystem block diagram. However, during the code generation process, one `VariantMerge` block is placed at the input of each `Outport` block within the Variant Subsystem block diagram. All of the child subsystems connect to each of the `VariantMerge` blocks.

In the figure below, the code generation process makes the following connections and adds `VariantMerge` blocks to the `sldemo_variant_subsystems` model.

When compared to a generic `Merge` block the `VariantMerge` block can have only one parameter which is the number of `Inputs`. The `VariantMerge` block is used for code generation in variant subsystems internally, and is not available externally to be used in models. The number of inputs for `VariantMerge` is determined and wired as shown in the figure below.

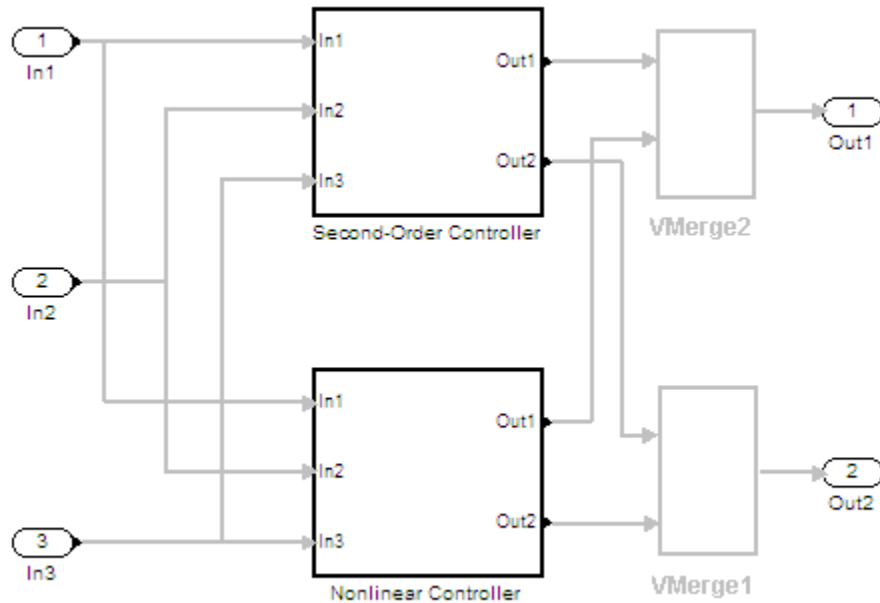

The child subsystems of the Variant Subsystem block must be atomic subsystems. Select **Treat as atomic unit** parameter in the Subsystem block parameters dialog, to make the subsystems atomic. The **VariantMerge** blocks are inserted at the output of the subsystems if more than one child subsystems are present. If the source block of a **VariantMerge** block input is non-virtual, an error message will be displayed during code generation. You must make the source block contiguous, by inserting Signal Conversion blocks inside the variant choices. The **VariantMerge** block does not support variable dimensions through it, so you cannot have child subsystems with different output signal dimensions.

Special Considerations for Generating Preprocessor Conditionals

When you select the **Generate preprocessor conditionals** parameter, consider the following:

- The code generation process checks that the inports and outports of a Variant Subsystem block or a Model Variants block must be identical (same port numbers and names) to the corresponding inports and outports of its variants. The build process for simulation does not make this check. Therefore, if your variant block contains mismatched inports or outports, the code generation process issues an error.
- The code generation process checks that there is at least one active variant by using the variant control values stored in the base workspace. If you are generating preprocessor conditionals and using an external header file for the values of the variant controls, the code generator issues an error if the values in the base workspace do not indicate an active variant.
- If you comment out child subsystems listed in the **Variant Choices** table in the Variant Subsystem block parameter dialog box, the code generator does not generate code for the commented out subsystems.

Limitations on Generating Code for Variants

When you are generating code for Model Variants blocks and Variant Subsystem blocks, the blocks cannot have:

- Continuous states or mass matrices
- Function call ports
- Outports with constant sample time
- The Model Variants block and its referenced models must have the same number of inports and outports.
- The Variant Subsystem block and its active child subsystems must have the same number of inports and outports.
- All of the port numbers and names for each active child subsystem in a Variant Subsystem block must also match.

Generated Code Components Not Compiled Conditionally

The following components in the generated code are not compiled conditionally. This is true even if they are referenced only by code for variant subsystems or models that are conditionally compiled.

- `rtModel` data structure fields
- `#include`'s of utility files
- Global non-constant parameter structure fields; when the configuration parameter **Optimization > Signals and Parameters > Parameter structure** is set to `NonHierarchical`
- Global constant parameter structure fields that are referenced by multiple subsystems activated by different variants
- Parameters that are configured to use an imported, exported, or custom code generation storage class, and are referenced by multiple subsystems that are activated by different variants
- Parameters that are configured to use an imported, exported, or custom code generation storage class, and are used by variant model blocks

Scheduling Considerations

- “Use Discrete and Continuous Time” on page 7-2
- “Optimize Multirate Multitasking Operation on RTOS Targets” on page 7-4

Use Discrete and Continuous Time

In this section...
“Support for Discrete and Continuous Time Blocks” on page 7-2
“Support for Continuous Solvers” on page 7-2
“Support for Stop Time” on page 7-3

Support for Discrete and Continuous Time Blocks

The ERT target supports code generation for discrete and continuous time blocks. If the **Support continuous time** option is selected, you can use these blocks in your models, without restriction.

Note that use of certain blocks is not recommended for production code generation for embedded systems. The Simulink Block Data Type Support table summarizes characteristics of blocks in the Simulink and Fixed-Point Designer block libraries, including whether or not they are recommended for use in production code generation. To view this table, execute the following command and see the “Code Generation Support” column of the table that appears:

```
showblockdatatypetable
```

Support for Continuous Solvers

The ERT target supports continuous solvers. In the **Solver** options dialog, you can select an available solver in the **Solver** menu. (Note that the solver **Type** must be **fixed-step** for use with the ERT target.)

Note Custom targets must be modified to support continuous time. The required modifications are described in “Custom Targets” in the Simulink Coder documentation.

Support for Stop Time

The ERT target supports the stop time for a model. When generating host-based executables, the stop time value is honored if one of the following is true:

- **Classic call interface** is selected on the **Interface** pane
- **External mode** is selected in the **Data exchange** subpane of the **Interface** pane
- **MAT-file logging** is selected on the **Interface** pane

Otherwise, the executable runs indefinitely.

Note The ERT target provides both generated and static examples of the `ert_main.c` file. The `ert_main.c` file controls the overall model code execution by calling the `model_step` function and optionally checking the `ErrorStatus/StopRequested` flags to terminate execution. For a custom target, if you provide your own custom static `main.c`, you should consider including support for checking these flags.

Optimize Multirate Multitasking Operation on RTOS Targets

In this section...
“Overview” on page 7-4
“Use rtmStepTask” on page 7-5
“Scheduling Code for Multirate Multitasking on VxWorks” on page 7-5
“Suppress Redundant Scheduling Calls” on page 7-6

Overview

Using the `rtmStepTask` macro, targets that employ the task management mechanisms of an RTOS can eliminate certain redundant scheduling calls during the execution of tasks in a multirate, multitasking model, thereby improving performance of the generated code.

To understand the optimization that is available for an RTOS target, consider how the ERT target schedules tasks for bareboard targets (where RTOS is not present). The ERT target maintains *scheduling counters* and *event flags* for each subrate task. The scheduling counters are implemented within the real-time model (rtM) data structure as arrays, indexed on task identifier (`tid`).

The scheduling counters are updated by the base-rate task. The counters are clock rate dividers that count up the sample period associated with each subrate task. When a given subrate counter reaches a value that indicates it has a hit, the sample period for that rate has elapsed and the counter is reset to zero. When this occurs, the subrate task must be scheduled for execution.

The event flags indicate whether or not a given task is scheduled for execution. For a multirate, multitasking model, the event flags are maintained by code in the main program for the model. For each task, the code maintains a task counter. When the counter reaches 0, indicating that the task's sample period has elapsed, the event flag for that task is set.

On each time step, the counters and event flags are updated and the base-rate task executes. Then, the scheduling flags are checked in `tid` order, and tasks

whose event flag is set is executed. Therefore, tasks are executed in order of priority.

For bareboard targets that cannot rely on an external RTOS, the event flags are mandatory to allow overlapping task preemption. However, an RTOS target uses the operating system itself to manage overlapping task preemption, making the maintenance of the event flags redundant.

Use `rtmStepTask`

The `rtmStepTask` macro is defined in `model.h` and its syntax is as follows:

```
boolean task_ready = rtmStepTask(rtm, idx);
```

The arguments are:

- `rtm`: pointer to the real-time model structure (`rtM`)
- `idx`: task identifier (`tid`) of the task whose scheduling counter is to be tested

`rtmStepTask` returns `TRUE` if the task's scheduling counter equals zero, indicating that the task should be scheduled for execution on the current time step. Otherwise, it returns `FALSE`.

If your target supports the **Generate an example main program** parameter, you can generate calls to `rtmStepTask` using the TLC function `RTMTaskRunsThisBaseStep`.

Scheduling Code for Multirate Multitasking on VxWorks

The following task scheduling code, from `ertmainlib.tlc`, is designed for multirate multitasking operation on a Wind River® Systems VxWorks® target. The example uses the TLC function `RTMTaskRunsThisBaseStep` to generate calls to the `rtmStepTask` macro. A loop iterates over each subrate task, and `rtmStepTask` is called for each task. If `rtmStepTask` returns `TRUE`, the VxWorks `semGive` function is called, and the VxWorks RTOS schedules the task to run.

```
%assign ifarg = RTMTaskRunsThisBaseStep("i")
```

```
for (i = 1; i < %<FcnNumST>; i++) {
    if (%<ifarg>) {
        semGive(taskSemList[i]);
        if (semTake(taskSemList[i],NO_WAIT) != ERROR) {
            logMsg("Rate for SubRate task %d is too fast.\n",i,0,0,0,0,0);
            semGive(taskSemList[i]);
        }
    }
}
```

Suppress Redundant Scheduling Calls

Redundant scheduling calls are still generated by default for backward compatibility. To change this setting and suppress them, add the following TLC variable definition to your system target file before the `%include "codegenentry.tlc"` statement:

```
%assign SuppressSetEventsForThisBaseRateFcn = 1
```

Data, Function, and File Definition

- Chapter 8, “Data Types”
- Chapter 9, “Module Packaging Tool (MPT) Data Objects”
- Chapter 10, “Custom Storage Classes”
- Chapter 11, “User Package Registration”
- Chapter 12, “Function and Class Interfaces”
- Chapter 13, “Memory Sections”

Data Types

- “Apply User-Defined Data Types” on page 8-2
- “Specify Persistence Level for Signals and Parameters” on page 8-7
- “Buses” on page 8-11
- “Rename Built-In Data Types” on page 8-30
- “Generate Code Including User-Defined Data Types” on page 8-32
- “Data Type Replacement” on page 8-44
- “Data Definition and Declaration Management” on page 8-55

Apply User-Defined Data Types

In this section...
“Define User Data Types” on page 8-2
“Select User-Defined Data Types” on page 8-4

Define User Data Types

You can use user-defined data types for Simulink signals and parameters and their corresponding identifiers in generated code. This is true whether or not a signal or parameter has a Simulink data object associated with it.

Before you can select a user-defined data type for a signal or parameter, you must:

- 1 Create a user data type (alias), as explained in the description of `Simulink.AliasType` in the Simulink documentation. For the example in “Select User-Defined Data Types” on page 8-4 that shows how to select user data types for signals and parameters, create the alias data type `f32`.
- 2 Register the user data type so that it is associated with the corresponding MathWorks C/C++ data type, as explained in “Create Data Types for mpt Data Objects” on page 8-35.

Note Dialog boxes that contain the data type field display user-defined data types for both `mpt` as well as Simulink data objects. Modifications you make to `sl_customization.m` in order to display user-defined data types are still supported.

For the example, register the data type `f32` so that it is associated with type `real32_T`. The call to function `addUserDataTypes` in the `sl_customization.m` file you use for the registration must specify:

- `f32` as the user data type
- `real32_T` as the built-in data type

- `<userdata_types.h>` as the user header file that is to include the user data type definition

For example,

```
function sl_customization(cm)
hObj = cm.slDataObjectCustomizer;
addUserDataTypes(hObj, 'f32', 'real32_T', '<userdata_types.h>');
end
```

- 3 If you have not already done so, add the directory containing the `sl_customization.m` file that you created or modified in step 1 to the MATLAB search path.
- 4 Open a model. The example uses the following model.

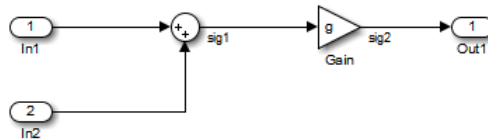

- 5 Create a data dictionary for the model, as explained in “Create Simulink and mpt Data Objects” on page 8-56, to associate signals and parameters with data objects. For the example, the Model Explorer display must appear as shown below. The three data objects that appear, `sig1`, `sig2`, and `g`, and the registered user data type, `f32`, appear in the middle pane. The “**T**” indicates that `f32` is an alias data type.

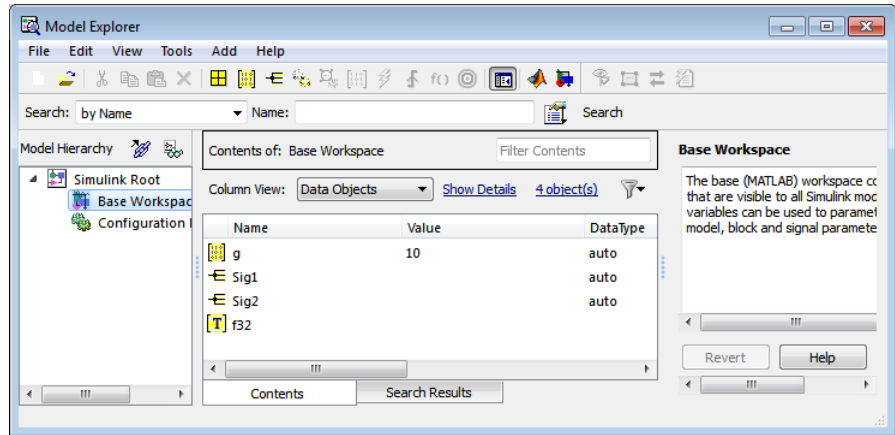

For the selection procedure and to continue with the example, continue to “Select User-Defined Data Types” on page 8-4.

Select User-Defined Data Types

After completing the preparation explained in “Define User Data Types” on page 8-2, you can use the user-defined data types for Simulink signals and parameters and for their corresponding identifiers in the generated code. You can use user-defined data types with signals and parameters whether or not they have Simulink objects associated with them.

- 1 For an **mpt** object that is associated with a signal or parameter in your model, in the **Data type** field, select the user data type that you want. For example, select **f32**, for **sig1**.

This selects **f32** for the **sig1** data object in the data dictionary, but does not select **f32** for the corresponding labeled signal in the model. Therefore, the two may be in conflict. If you try to update the model, you could get an error message.

To continue with the example, type **f32** into the **Data type** field for **sig1**.

- 2 Select the model and double-click the signal or parameter source block. (The source block of a model signal or parameter controls the signal’s or parameter’s data type.) For example, in the example model the Sum block

is the source block for `sig1`. Double-click the Sum block. The Function Block Parameters dialog box opens.

- 3 Select the **Signal Attributes** tab.
- 4 In the **Output data type** or **Parameter data type** field, type the name of the user data type that you specified for the data object in step 1, and click **Apply**. The user data type of the signal in the model and that of the signal object are now the same.

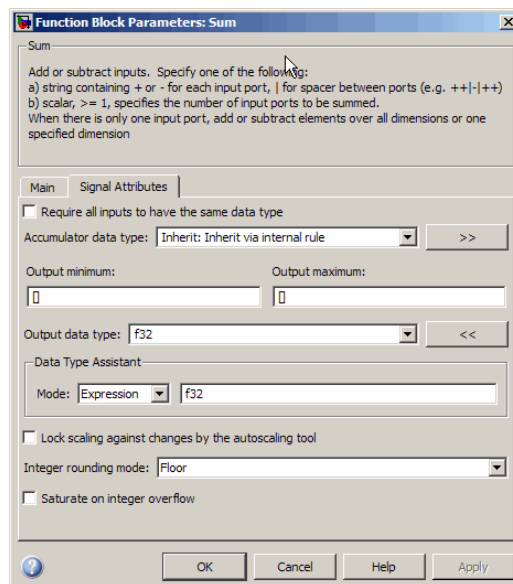

Alternatively, you can use dictionary-driven data typing. In the **Output data type** field, specify `object.DataType`, where `object` is the case-sensitive object name. For example, you can specify `sig1.DataType` instead of `f32`.

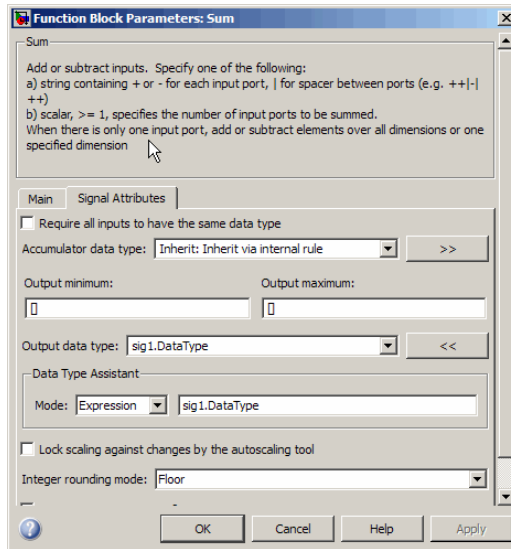

The advantage of using the alternative is that subsequent user data type changes for the object in the dictionary automatically change the user data type of the corresponding model signal or parameter.

- 5 Repeat steps 1 through 4 for each remaining model signal and parameter that has a corresponding signal object for which you selected a user data type.
- 6 Save the model and corresponding data objects in the MATLAB base workspace in a `.mat` file for reuse later. Generated code for `sig1` in the example model (with default MPF settings) would appear as follows:

```
In sampleUserDT.c           f32 sig1;
In sampleUserDT_types.h    #include <userdata_types.h>
```

Specify Persistence Level for Signals and Parameters

With this procedure, you can control the persistence level of signal and parameter objects associated with a model. Persistence level allows you to make intermediate variables or parameters global during initial development. At the later stages of development, you can use this procedure to remove these signals and parameters for efficiency. Notice the **Persistence Level** field on the Model Explorer, as illustrated in the figure below. For descriptions of the properties on the Model Explorer, see Parameter and Signal Property Values on page 9-3.

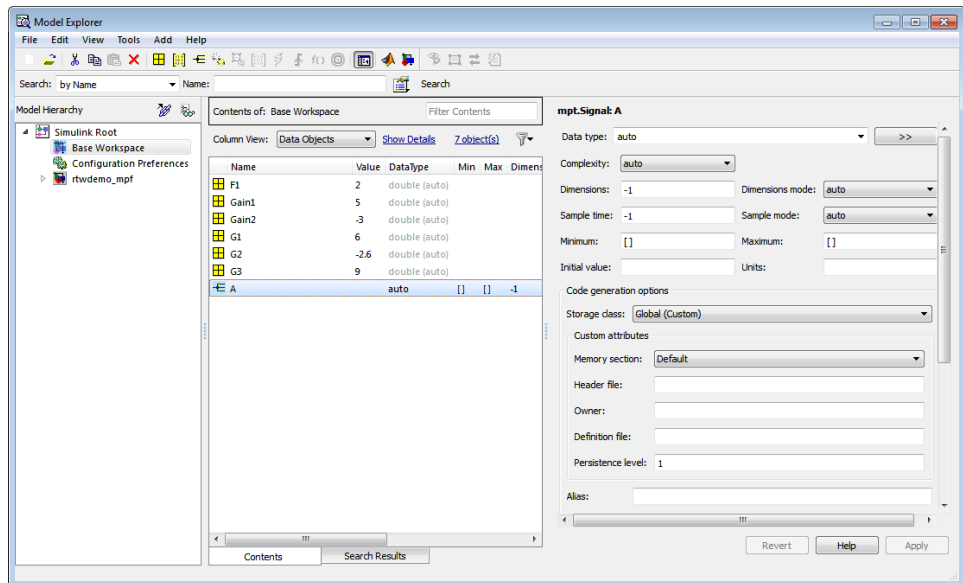

Notice also the **Signal display level** and **Parameter tune level** fields on the **Code Placement** pane of the Configuration Parameters dialog box, as illustrated in the next figure.

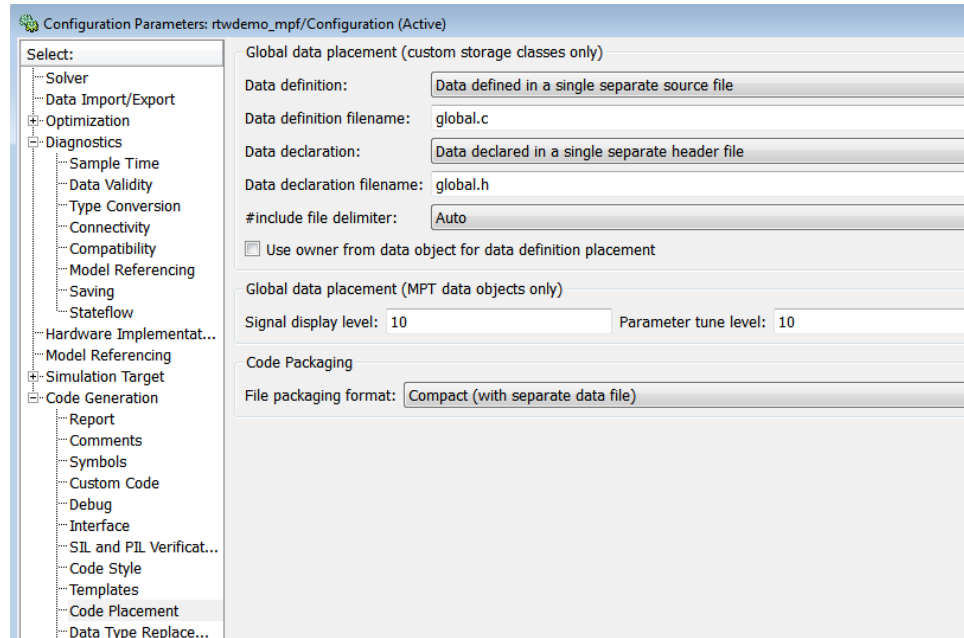

The **Signal display level** field allows you to specify whether or not the code generator defines a signal data object as global data in the generated code. The number you specify in this field is relative to the number you specify in the **Persistence level** field. The **Signal display level** number is for mpt (module packaging tool) signal data objects in the model. The **Persistence level** number is for a *particular* mpt signal data object. If the data object's **Persistence level** is equal to or less than the **Signal display level**, the signal appears in the generated code as global data with the properties (custom attributes) specified in “Create mpt Data Objects with Data Object Wizard” on page 8-63. For example, this would occur if **Persistence level** is 2 and **Signal display level** is 5.

Otherwise, the code generator automatically determines how the particular signal data object appears in the generated code. Depending on the settings on the **Optimization** pane of the Configuration Parameters dialog box, the signal data object could appear in the code as local data without the custom attributes you specified for that data object. Or, based on expression folding, the code generator could remove the data object so that it does not appear in the code. For more information, see “Code Optimization Basics”.

The **Parameter tune level** field allows you to specify whether or not the code generator declares a parameter data object as tunable global data in the generated code.

The number you specify in this field is relative to the number you specify in the **Persistence level** field. The **Parameter tune level** number is for mpt parameter data objects in the model. The **Persistence level** number is for a *particular* mpt parameter data object. If the data object's **Persistence level** is equal to or less than the **Parameter tune level**, the parameter appears in the generated code with the properties (custom attributes) specified in “Create mpt Data Objects with Data Object Wizard” on page 8-63, and thus is tunable. For example, this would occur if **Persistence level** is 2 and **Parameter tune level** is 5.

Otherwise, the parameter is inlined in the generated code, and the code generation settings determine its exact form.

Note that, in the initial stages of development, you might be more concerned about debugging than code size. Or, you might want one or more particular data objects to appear in the code so that you can analyze intermediate calculations of an equation. In this case, you might want to specify the **Parameter tune level (Signal display level for signals)** to be higher than **Persistence level** for some mpt parameter (or signal) data objects. This results in larger code size, because the code generator defines the parameter (or signal) data objects as global data, which have the custom properties you specified. As you approach production code generation, however, you might have more concern about reducing the size of the code and less need for debugging or intermediate analyses. In this stage of the tradeoff, you could make the **Parameter tune level (Signal display level for signals)** greater than **Persistence level** for one or more data objects, generate code and observe the results. Repeat until satisfied.

- 1** With the model open, in the Configuration Parameters dialog box, click **Code Generation > Code Placement**.
- 2** Type the desired number in the **Signal display level** or **Parameter tune level** field, and click **Apply**.
- 3** In the Model Explorer, type the desired number in the **Persistence** field for the selected signal or parameter, and click **Apply**.

4 Save the model and generate code.

Buses

In this section...

“About Buses and Code Generation” on page 8-11

“Set Bus Diagnostics” on page 8-12

“Optimize Virtual and Nonvirtual Buses” on page 8-12

“Use Single-Rate and Multi-Rate Buses” on page 8-15

“Set Bus Signal Initial Values” on page 8-20

“Use Buses with Atomic Subsystems” on page 8-25

About Buses and Code Generation

When you use buses in a model for which you intend to generate code:

- Setting diagnostic configuration parameters can add to the ease of development.
- The bus implementation techniques used can influence the speed, size, and clarity of that code.
- Some bus implementation techniques that can be useful are not immediately obvious.

This chapter contains guidelines that you can use to improve the results when you work with buses. The guidelines describe techniques for:

- Simplifying the layout of the model
- Increasing the efficiency of generated code
- Defining data structures for function/subsystem interfaces
- Defining data structures that match existing data structures in external C code

Some trade-offs inevitably exist among speed, size, and clarity. For example, the code for nonvirtual buses is easier to read because the buses appear in the code as structures, but the code for virtual buses is faster because virtual

buses do not require copying signal data. The applicability of some guidelines can therefore depend on where you are in the application development process.

This chapter focuses on optimizations that are useful for final production code. Before you read this chapter, read “Composite Signals”. This topic assumes that you understand the concepts and procedures described in that one, including the blocks used for creating and manipulating buses.

Set Bus Diagnostics

Simulink provides diagnostics that you can use to optimize bus usage. Set the following values on the **Configuration Parameters** > **Diagnostics** > **Connectivity** pane:

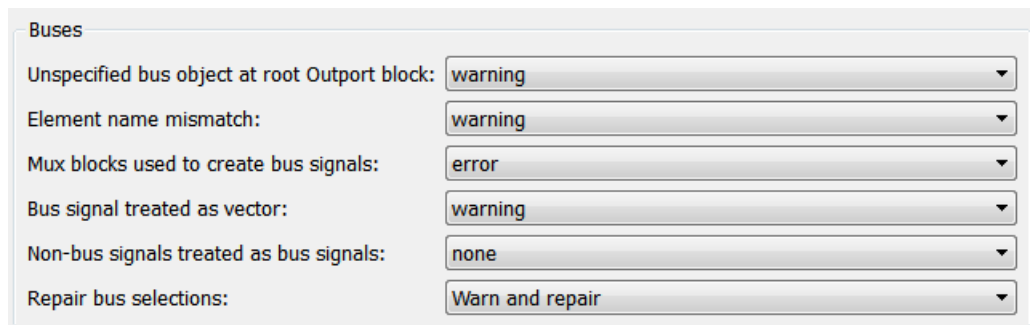

Buses	
Unspecified bus object at root Output block:	warning
Element name mismatch:	warning
Mux blocks used to create bus signals:	error
Bus signal treated as vector:	warning
Non-bus signals treated as bus signals:	none
Repair bus selections:	Warn and repair

Bus signal treated as vector is enabled only when **Mux blocks used to create bus signals** is set to error. Setting **Mux blocks used to create bus signals** to **None** disables both diagnostics. Temporarily disabling the two mux and bus diagnostics allows you to debug other bus problems before addressing mux and bus mixtures. You can then enable the last two diagnostics and use them to eliminate such mixtures. When you build existing models, the diagnostic settings should be as shown. See “Avoid Mux/Bus Mixtures” for more information.

Optimize Virtual and Nonvirtual Buses

- “Use Virtual Buses Wherever Possible” on page 8-13
- “Avoid Nonlocal Nested Buses in Nonvirtual Buses” on page 8-14

Use Virtual Buses Wherever Possible

Virtual buses are graphical conveniences that do not affect generated code. As a result, the code generation engine is able to fully optimize the signals in the bus. You should therefore use virtual rather than nonvirtual buses wherever possible. You can convert between virtual and nonvirtual buses using Signal Conversion blocks. In many cases, Simulink automatically converts a virtual bus to a nonvirtual bus when required. For example, a virtual bus input to a Model block becomes a nonvirtual bus without the need for explicit conversion. See for more information.

When are Virtual and Nonvirtual Buses Required? In some cases, Simulink requires the use of nonvirtual buses:

- For non-auto storage classes
- Inports and Outports of Model blocks
- To generate a specific structure from the bus
- Root level Inport or Outport blocks when the bus has mixed data types

In one case, Simulink requires the use of virtual buses:

- Only virtual buses can be used for bundling function call signals.

Avoid Nonlocal Nested Buses in Nonvirtual Buses

Buses can contain subordinate buses. The storage class of a subordinate bus should be `auto`, which results in a local signal. Setting a subordinate bus to a non-`auto` storage class has two undesirable results:

- Allocation of redundant memory (memory for the subordinate bus object and memory for the final bus object)
- Additional copy operations (first copying to the subordinate bus and then copying from the subordinate bus to the final bus)

In the following example, the final bus is created from local scoped subordinate elements. The resulting assignment operations are relatively efficient:

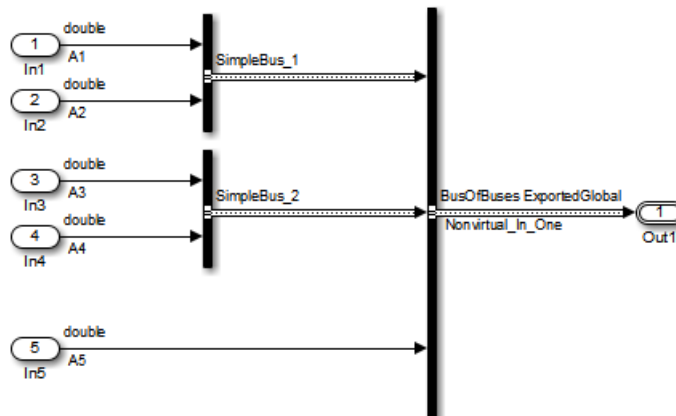

```

34 void bus_in_steps_a_step(void)
35 {
36     Nonvirtual_In_One.Simp_1.enableFlag = A1;
37     Nonvirtual_In_One.Simp_1.calValues[0] = A2[0];
38     Nonvirtual_In_One.Simp_1.calValues[1] = A2[1];
39     Nonvirtual_In_One.Simp_2.Entry_1 = A3;
40     Nonvirtual_In_One.Simp_2.Entry_2_Array[0] = A4[0];
41     Nonvirtual_In_One.Simp_2.Entry_2_Array[1] = A4[1];
42     Nonvirtual_In_One.A_Vector[0] = A5[0];
43     Nonvirtual_In_One.A_Vector[1] = A5[1];
44     Nonvirtual_In_One.A_Vector[2] = A5[2];
45 }

```

By contrast in the next example the subordinate elements Sub_Bus_1 and Sub_Bus_2 are global in scope. First the assignment to the subordinate bus occurs (lines 54 – 59) then the copy of the subordinate bus to the main bus (lines 60 – 61). In most cases, this is not an efficient implementation:

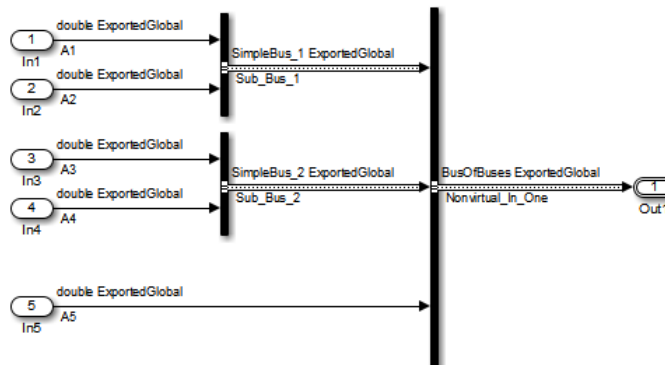

```

52 void bus_in_steps_b_step(void)
53 {
54     Sub_bus_1.enableFlag = A1;
55     Sub_bus_2.Entry_1 = A3;
56     Sub_bus_1.calValues[0] = A2[0];
57     Sub_bus_2.Entry_2_Array[0] = A4[0];
58     Sub_bus_1.calValues[1] = A2[1];
59     Sub_bus_2.Entry_2_Array[1] = A4[1];
60     Nonvirtual_In_Steps.Simp_1 = Sub_bus_1;
61     Nonvirtual_In_Steps.Simp_2 = Sub_bus_2;
62     Nonvirtual_In_Steps.A_Vector[0] = A5[0];
63     Nonvirtual_In_Steps.A_Vector[1] = A5[1];
64     Nonvirtual_In_Steps.A_Vector[2] = A5[2];
65 }

```

Use Single-Rate and Multi-Rate Buses

- “Introduction” on page 8-16
- “Techniques for Combining Multiple Rates” on page 8-16
- “Larger Buses and Multiple Rates” on page 8-18

- “Specify Sample Time Rates” on page 8-20

Introduction

Nonvirtual buses do not support multiple rates. Virtual buses support multiple rates as long as the bus does not cross a root level inport or outport. The best techniques for optimizing a bus that contains signals that initially have different rates can depend on the type of the bus and the number of signals.

Techniques for Combining Multiple Rates

The simplest bus contains only two signals. The next figure shows two examples of two-element buses. The first example shows a virtual bus created from two signals that have different rates. The second example shows a nonvirtual bus created from the same two signals. The Sample Time Legend shows the different signal rates:

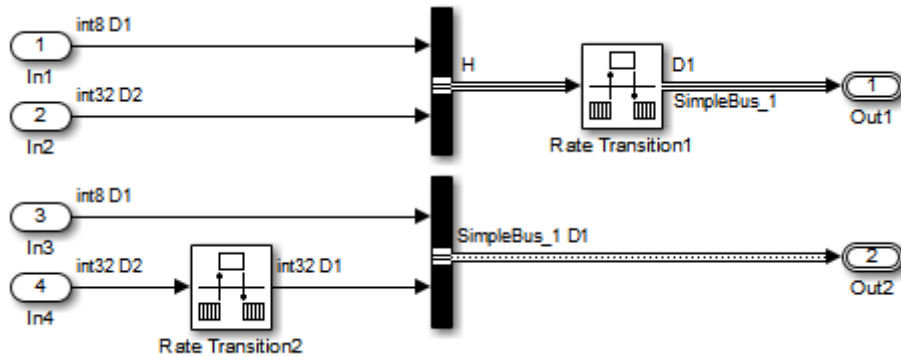

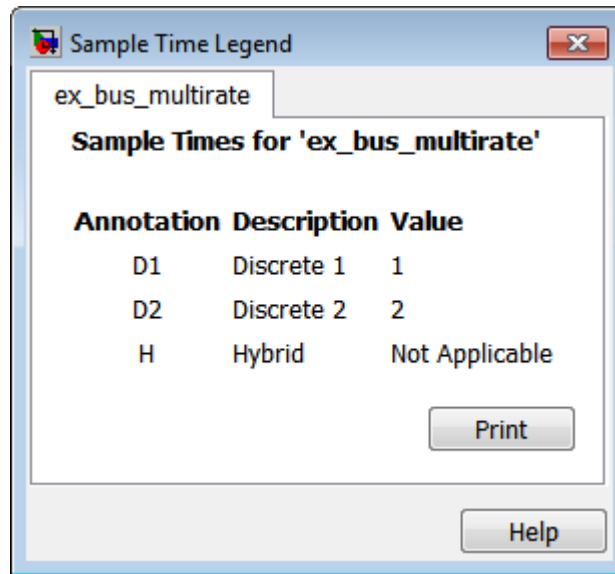

The signals with different rates in the first example can be combined into a virtual bus, because virtual buses support multiple rates. However, a multirate virtual bus cannot connect to a root-level output port. The bus therefore passes through a Rate Transition block that converts it to a single-rate bus, then connects to the Outputport. This technique is preferable only for virtual buses that contain one or two signals. See “Larger Buses and Multiple Rates” on page 8-18.

The signals with different rates in the second example cannot initially be combined into a nonvirtual bus, because nonvirtual buses do not support multiple rates. One of the signals therefore passes through a Rate Transition block, which converts it to have the same rate as the other signal, then connects to the Bus Creator block. The signals can then combine into a single-rate nonvirtual bus, which can connect to the root-level outputport without further conversion.

Larger Buses and Multiple Rates

When you create a multirate virtual bus that contains more than two signals, you can convert the bus to single-rate by applying a Rate Transition block to the output of the Bus Creator block. Use a Rate Transition block on each input signal to give full control over the output rate. As the next figure shows, when a single Rate Transition block is used, the block sets the signals to the fastest rate (D1):

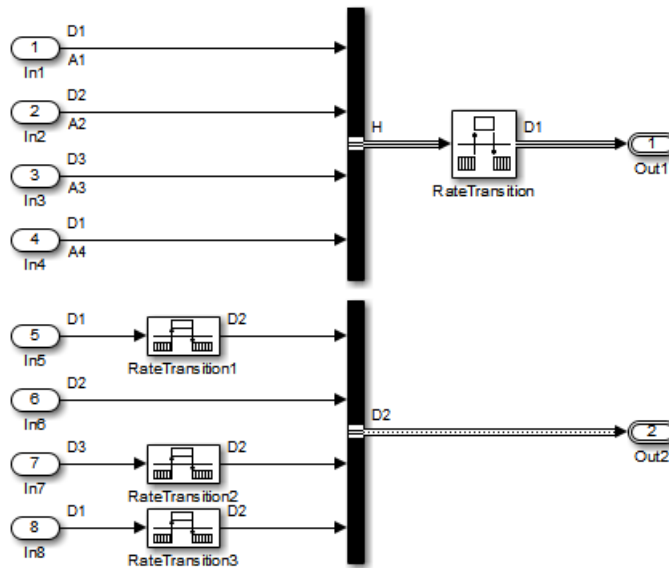

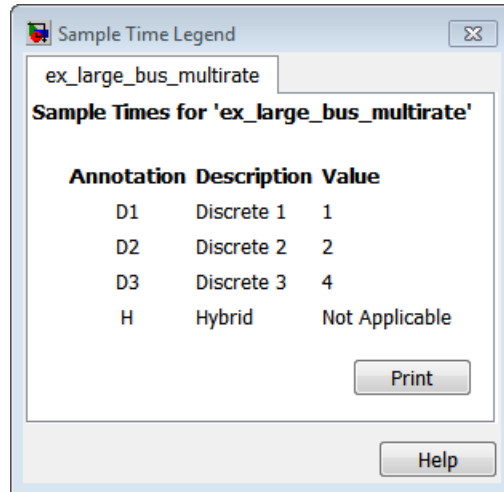

Note that the preferred techniques for a virtual bus with more than two signals, and the required technique for a nonvirtual bus with one or more signals, are the same. Note also that, in the preceding figure, the blocks that perform rate transition are not actual Rate Transition blocks, but other blocks that can change the signal rate as part of some other operation. The identity of the blocks that perform rate transition is not as significant; what matters is that the signal rates match when required.

Specify Sample Time Rates

The sample time for buses should be specified through the signals that define the bus. If the sample times do not match, use Rate Transition (or equivalent) blocks to create a uniform rate, as shown in the previous figures. The signal rates should *not* be set by specifying **Sample Time** values in a Bus Creator block's bus object. Instead, set the sample time for each signal before inputting it to the Bus Creator, and set each **Sample Time** in the corresponding bus object to -1, which indicates the value is inherited.

Set Bus Signal Initial Values

- “Introduction” on page 8-20
- “Initialize Bus Signals in Simulink” on page 8-20
- “Bus Initialization in Stateflow” on page 8-21
- “Create a Bus of Constants” on page 8-24

Introduction

Unlike scalar and vector signals, buses do not provide a direct way to initialize signals. This section describes techniques for initializing bus signals using Simulink, Stateflow, and MATLAB functions.

Initialize Bus Signals in Simulink

In Simulink, you can set initial values on a bus by using a set of conditionally executed subsystems, such as Function-Call subsystems, and a Merge block, as shown in this example:

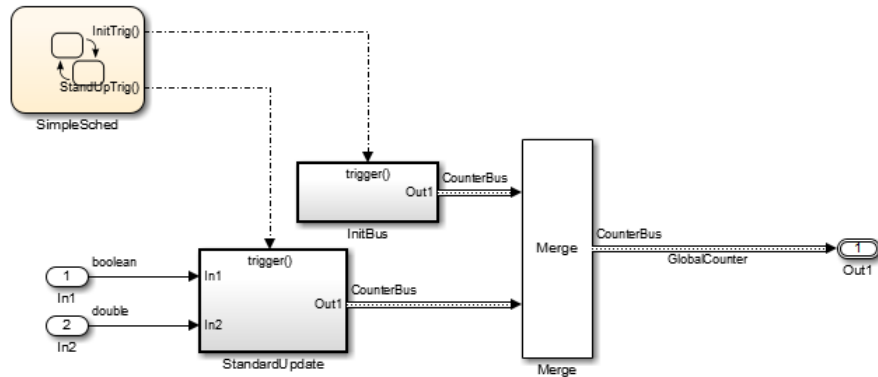

Both subsystems (`InitBus` and `StandardUpdate`) create a bus signal of type `CounterBus`. However, the assignment to the variable `GlobalCounter` is controlled by the `Merge` block. See “Function-Call Subsystems” for more information.

This technique is limited because the `StandardUpdate` subsystem does not use the initial values from the `InitBus` subsystem. If the calculations depend on past information from the bus, consider using `Stateflow` or `MATLAB` functions to initialize bus signals.

Bus Initialization in Stateflow

`Stateflow` and `MATLAB` functions allow for conditional execution internally. In the following example, the `init` and `update` code are Functions in the `Stateflow` diagram. This technique simplifies the presentation in the generated code:

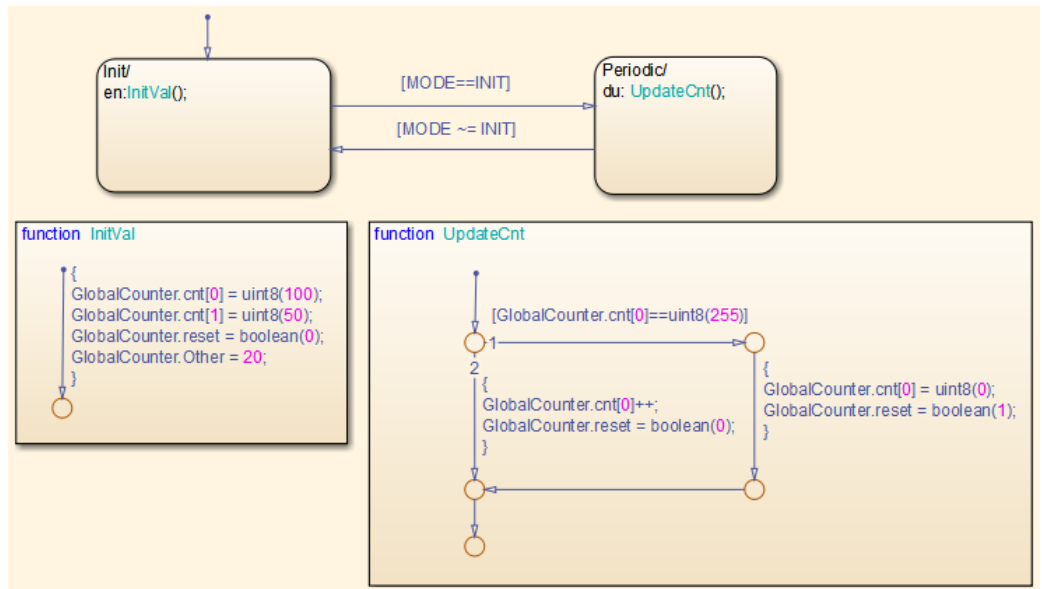

In the generated code, you can see that the `UpdateCnt` function uses the past value of `GlobalCounter.cnt`:



```

static void initBus_4_Stateflow_Arr_initVal(void)
{
    GlobalCounter.cnt[0] = 100U;
    GlobalCounter.cnt[1] = 50U;
    GlobalCounter.reset = false;
    GlobalCounter.Other = 20.0;
}

static void initBus_4_Stateflow_A_UpdateCnt(void)
{
    if (GlobalCounter.cnt[0] == 255) {
        GlobalCounter.cnt[0] = 0U;
        GlobalCounter.reset = true;
    } else {
        GlobalCounter.cnt[0] = (uint8_T)(GlobalCounter.cnt[0] + 1);
        GlobalCounter.reset = false;
    }
}

```

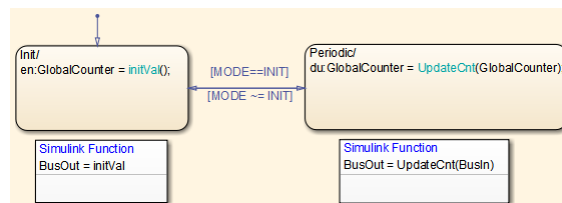
The previous example used Stateflow Graphical functions to initialize and update the buses. Alternatively, you can use MATLAB functions or Simulink subsystems embedded in a Stateflow diagram. The next figure illustrates this technique:



The Simulink subsystems are the same as those used in the earlier Simulink-only example.

Create a Bus of Constants

The code for specifying a bus of constant values will appear in either the `Init` or the `Step` function of the model. The code location depends on the configuration of the bus. In most cases the code appears in the `Step` function. However if the following conditions hold the code will be placed in the `Init` function:

- The bus is a virtual bus
- The signals in the bus have the same data type
- The signals in the bus are constants

In the next figure, only the bus named `Bus_2` meets the requirements:

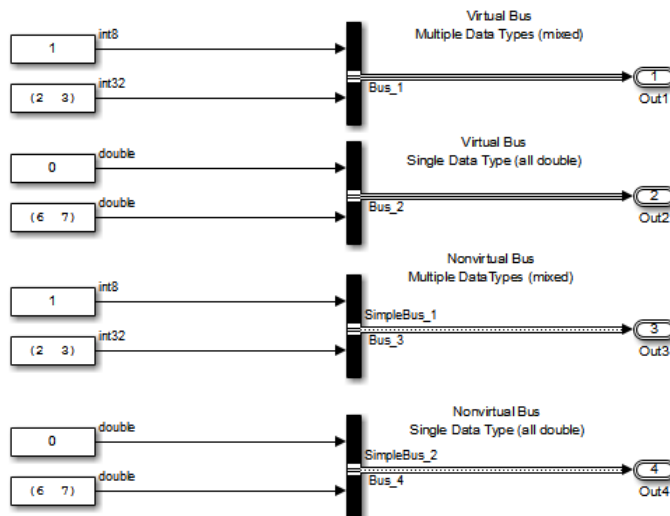

The code for `Bus_2` therefore appears in the `Init` function. The code for the other buses appears in the `Step` function:

```

SimpleBus_2 Bus_4;
SimpleBus_1 Bus_3;
ExternalOutputs_busOfConstants_busOfConstants_A_Y;
RT_MODEL_busOfConstants_A_busOfConstants_A_M;
RT_MODEL_busOfConstants_A *busOfConstants_A_M = &busOfConstants_A_M;
void busOfConstants_A_step(void)
{
    busOfConstants_A_Y.Out_1.enableFlag = 1;
    Bus_3.enableFlag = 1;
    Bus_4.Entry_1 = 0.0;
    busOfConstants_A_Y.Out_1.calValues[0] = 2;
    Bus_3.calValues[0] = 2;
    Bus_4.Entry_2_Array[0] = 6.0;
    busOfConstants_A_Y.Out_1.calValues[1] = 3;
    Bus_3.calValues[1] = 3;
    Bus_4.Entry_2_Array[1] = 7.0;
}

void busOfConstants_A_initialize(void)
{
    busOfConstants_A_Y.Out_2[0] = 0.0;
    busOfConstants_A_Y.Out_2[1] = 6.0;
    busOfConstants_A_Y.Out_2[2] = 7.0;
}

```

To avoid repeatedly updating a bus of constants, place the bus code into a function-call subsystem, as described in “Initialize Bus Signals in Simulink” on page 8-20. When you use this technique, make sure the function-call subsystem is called at the start of execution. See “Function-Call Subsystems” for more information.

Use Buses with Atomic Subsystems

- “Extract Nonvirtual Bus Signals from Atomic Subsystems” on page 8-26
- “Virtual Bus Signals Crossing Atomic Boundaries” on page 8-27
- “Atomic Subsystems and Buses of Constants” on page 8-29

Extract Nonvirtual Bus Signals from Atomic Subsystems

Selecting signals from a nonvirtual bus can result in unnecessary data copies when those signals cross an atomic boundary. In the following example the same code, a simple multiplication of two elements in a vector, is executed three times:

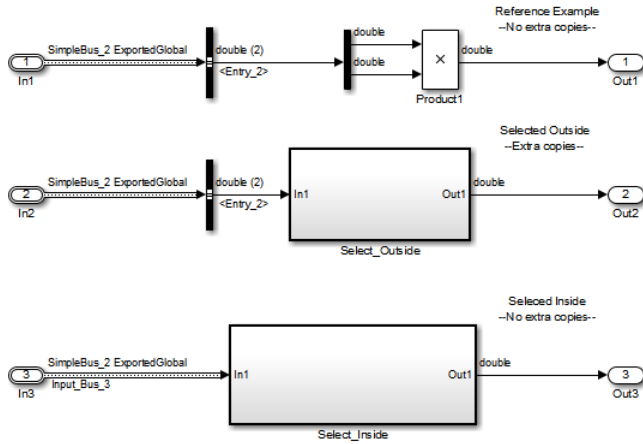

In the second instance when the bus signals are selected outside of the atomic subsystem an unnecessary copy of the bus data is created.

Although this example shows only signals with global scope, both global and local signals show the same behavior: the selection of the signals outside of the model results in an unnecessary copy, while the internal selection does not.

Virtual Bus Signals Crossing Atomic Boundaries

Virtual buses that cross atomic boundaries can result in the creation of unnecessary data copies. The following example shows the data copy that occurs when a virtual bus crosses an atomic boundary:

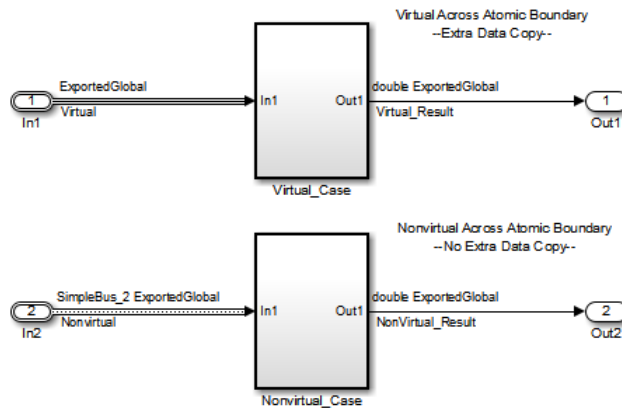

```
12 void virtualAcrossBo_Nonvirtual_Case(void)
13 {
14     Nonvirtual_Result = Nonvirtual.Entry_2_Array[0] * Nonvirtual.Entry_2_Array[1];
15 }
16
17 void virtualAcrossBound_Virtual_Case(void)
18 {
19     Virtual_Result = virtualAcrossBoundary_B.Entry_2_Array[0] *
20     virtualAcrossBoundary_B.Entry_2_Array[1];
21 }
22
23 void virtualAcrossBoundary_step(void)
24 {
25     virtualAcrossBoundary_B.Entry_2_Array[0] = Virtual.Entry_2_Array[0];
26     virtualAcrossBoundary_B.Entry_2_Array[1] = Virtual.Entry_2_Array[1];
27     virtualAcrossBound_Virtual_Case();
28     virtualAcrossBo_Nonvirtual_Case();
29 }
```

Lines 25–26 show the signals being selected out of the bus before they are used in the function on lines 19–20. By comparison the nonvirtual bus does not require the use of temporary variables.

Atomic Subsystems and Buses of Constants

If the bus passed into an atomic subsystem consists exclusively of constants, using a virtual bus is more efficient, because Simulink is able to inline the constant values into the code:

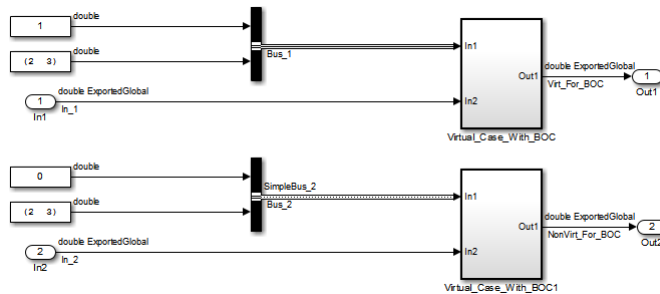

```
void virtualAc_Virtual_Case_With_BOC(void)
{
    Virt_For_BOC = 6.0 * In_1;
}
```

```
void virtualA_Virtual_Case_With_BOC1(void)
{
    NonVirt_For_BOC = virtualAcrossBoundaryBOC_B.Bus_2.Entry_2_Array[0] *
        virtualAcrossBoundaryBOC_B.Bus_2.Entry_2_Array[1] * In_2;
}
```

```
void virtualAcrossBoundaryBOC_step(void)
{
    virtualAc_Virtual_Case_With_BOC();
    virtualAcrossBoundaryBOC_B.Bus_2.Entry_1 = 1.0;
    virtualAcrossBoundaryBOC_B.Bus_2.Entry_2_Array[0] = 2.0;
    virtualAcrossBoundaryBOC_B.Bus_2.Entry_2_Array[1] = 3.0;
    virtualA_Virtual_Case_With_BOC1();
}
```

Rename Built-In Data Types

You can replace built-in data type names with user-defined replacement data type names in the generated code for a model.

To configure replacement data types,

- 1 In the Model Editor, set the simulation mode of the open model. From the **Simulation** menu, select **Normal**, **Software-in-the-loop (SIL)**, or **Processor-in-the-loop (PIL)**.
- 2 In the Configuration Parameters dialog box, click **Code Generation > Data Type Replacement > Replace data type names in the generated code**. A **Data type names** table appears. The table lists each Simulink built-in data type name with its corresponding code generation data type name.

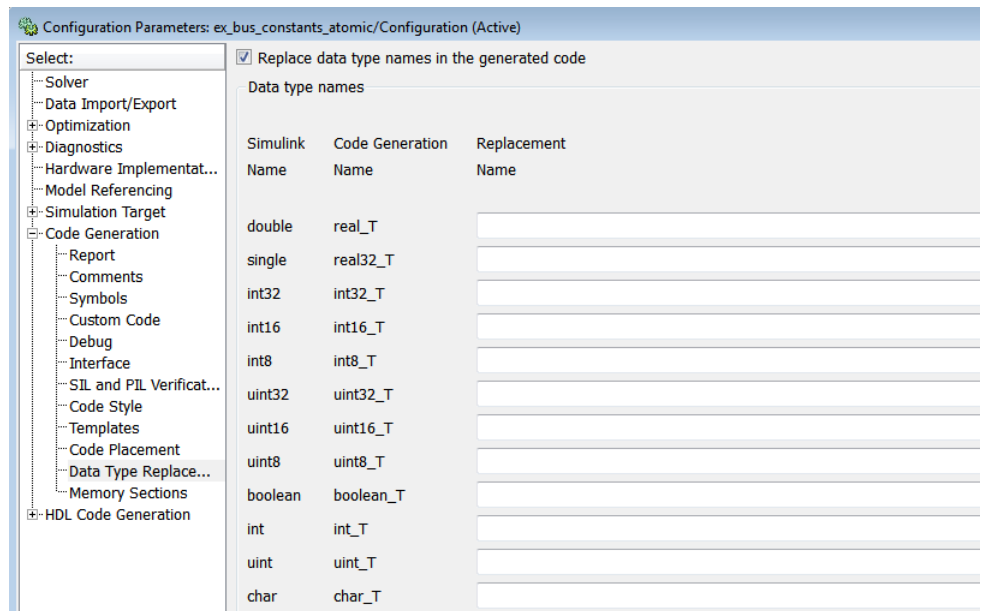

- 3 Fill in fields in the third column with your replacement data types. Each replacement data type should be the name of a `Simulink.AliasType` object

that exists in the base workspace. Replacements may be specified or not for each individual built-in type.

For each replacement data type you enter, the `BaseType` property of the associated `Simulink.AliasType` object must be consistent with the built-in data type it replaces.

- For `double`, `single`, `int32`, `int16`, `int8`, `uint32`, `uint16`, and `uint8`, the replacement data type's `BaseType` must match the built-in data type.
- For `boolean`, the replacement data type's `BaseType` must be either an 8-bit integer or an integer of the size displayed for **Number of bits: int** on the **Hardware Implementation** pane of the Configuration Parameters dialog box.
- For `int`, `uint`, and `char`, the replacement data type's size must match the size displayed for **Number of bits: int** or **Number of bits: char** on the **Hardware Implementation** pane of the Configuration Parameters dialog box.

An error occurs, if

- A replacement data type specification is inconsistent.
- The `Simulink.AliasType` object has the **Data scope** parameter set to `Exported`.

Generate Code Including User-Defined Data Types

In this section...

“About User-Defined Data Types” on page 8-32

“Specify Location of User-Defined Type Definitions” on page 8-33

“Apply User-Defined Data Types” on page 8-34

“Create Data Types for mpt Data Objects” on page 8-35

“Register mpt User Object Types” on page 8-39

About User-Defined Data Types

The Embedded Coder software supports use of user-defined data type objects in code generation. These include objects of the following classes:

- `Simulink.AliasType`
- `Simulink.Bus`
- `Simulink.NumericType`

For information on the properties and usage of these data object classes, see `Simulink.AliasType`, `Simulink.Bus`, and `Simulink.NumericType`. For general information on creating and using data objects, see the “Data Objects” section of the Simulink documentation

In code generation, you can use user-defined data objects to

- Map your own data type definitions to Simulink built-in data types, and specify that your data types are to be used in generated code.
- Optionally, generate `#include` directives specifying your own header files, containing your data type definitions. This technique lets you use legacy data types in generated code.

In general, code generated from user-defined data objects conforms to the properties and attributes of the objects as defined for use in simulation. When generating code from user-defined data objects, the name of the object is the name of the data type that is used in the generated code. Exception:

for `Simulink.NumericType` objects whose `IsAlias` property is false, the name of the functionally equivalent built-in or fixed-point Simulink data type is used instead.

Note The names of data types defined using `Simulink.AliasType` objects are preserved in the generated code only for installations with a Embedded Coder license.

Specify Location of User-Defined Type Definitions

When a model uses `Simulink.DataType` and `Simulink.Bus` objects, the generated code includes corresponding `typedef` definitions. Both `Simulink.DataType` and `Simulink.Bus` objects have a `HeaderFile` property that controls the location of the object's `typedef`. Setting a `HeaderFile` is optional and specific to code generation only.

Omit a HeaderFile Value

If the `HeaderFile` property for a `Simulink.DataType` or `Simulink.Bus` object is left empty, a generated `typedef` for the object appears in the generated file `model_types.h`.

Example. For a `Simulink.NumericType` object named `myfloat` with a `Category` of `double` and without `HeaderFile` property specified, `model_types.h` in the generated code contains:

```
typedef real_T myfloat;
```

Specify a HeaderFile Value

If the `HeaderFile` property for a `Simulink.DataType` or `Simulink.Bus` object is set to a string value,

- The string must be the name of a header file that contains a `typedef` for the object.
- The generated file `model_types.h` contains a `#include` that gives the header file name.

You can use this technique to include legacy or other externally created typedefs in generated code. When the generated code compiles, the specified header file must be accessible on the build process include path.

HeaderFile Property Syntax. The HeaderFile property should include the desired preprocessor delimiter (" " or '<>'), as in the following examples.

This example:

```
myfloat.HeaderFile = '<legacy_types.h>'
```

generates the directive:

```
#include <legacy_types.h>
```

This example:

```
myfloat.HeaderFile = '"legacy_types.h>"'
```

generates the directive:

```
#include "legacy_types.h"
```

Apply User-Defined Data Types

To specify and use user-defined data types for code generation:

- 1** Create a user-defined data object and configure its properties, as described in the “Data Objects” section of the Simulink documentation.
- 2** If you specified the HeaderFile property, copy the header file to the specified directory.
- 3** Set the output data type of selected blocks in your model to the user-defined data object. To do this, set the **Data type** parameter of the block to Specify with dialog. Then, enter the object name in the **Output data type** parameter.
- 4** The specified output data type propagates through the model and variables of the user-defined type are declared as required in the generated code.

Create Data Types for mpt Data Objects

- “User Data Types for mpt Data Objects” on page 8-35
- “Register User Data Types Using `sl_customization.m`” on page 8-36
- “User Data Type Customization Using `sl_customization.m`” on page 8-38

Note The capabilities described in this section apply only to mpt data objects.

User Data Types for mpt Data Objects

By default, MathWorks data types (such as `real32_T` and `uint8_T`) are used to define data in the generated code. If you prefer using your company-standard data types (such as `DBL` and `U8`), you can define user data types. To use this feature, you must register and create your data types so that the code generator can associate them with the corresponding MathWorks C/C++ data types. Then, the code generator will use your user data types in the generated code instead of the MathWorks C/C++ data types.

Code generation software automatically associates the MathWorks C/C++ data types with the equivalent ANSI³ C/C++ data types. If you want to use only the default MathWorks C/C++ data types, you do not need to register and create your own data types.

To register user data types, use the Simulink customization file `sl_customization.m`. This file is a mechanism that allows you to use MATLAB code to perform customizations of the standard Simulink user interface. The Simulink software reads the `sl_customization.m` file, if present on the MATLAB path, when it starts and the customizations specified in the file are applied to the Simulink session. For more information on the `sl_customization.m` customization file, see “Registering Customizations”.

Once you have registered your user data types using `sl_customization.m`, you must create the `Simulink.AliasType` objects corresponding to your user data types. If your model references a user data type either directly (for example, in the output data type of a block) or indirectly (for example,

3. ANSI[®] is a registered trademark of the American National Standards Institute, Inc.

a `Simulink.Signal` object data type is set to the user data type), you must create the corresponding `Simulink.AliasType` object before updating the model, running a simulation, or generating code. To create the `Simulink.AliasType` objects, you can:

- Invoke the MATLAB function `ec_create_type_obj` to programmatically create the required `Simulink.AliasType` objects
- Create `Simulink.AliasType` objects one at a time by selecting **Add > Simulink.AliasType** in the Model Explorer
- Create `Simulink.AliasType` objects one at a time by entering the MATLAB command `userdatatype = Simulink.AliasType`, where `userdatatype` is a user data type registered in `sl_customization.m`

Register User Data Types Using `sl_customization.m`

To register user data type customizations, you create an instance of `sl_customization.m` and include it on the MATLAB path of the Simulink installation that you want to customize. The `sl_customization` function accepts one argument: a handle to a customization manager object. For example,

```
function sl_customization(cm)
```

As a starting point for your customizations, the `sl_customization` function must first get the default (factory) customizations, using the following assignment statement:

```
hObj = cm.slDataObjectCustomizer;
```

You then invoke methods to register your customizations. The customization manager object includes the following methods for registering Simulink user data type customizations:

- `addUserDataTypes(hObj, userName, builtinName, userHeader)`
`addUserDataTypes(hObj, userName, builtinName)`
`addUserDataTypes(hObj, userName, aliasTypeObj)`
`addUserDataTypes(hObj, userName, numericTypeObj)`
`addUserDataTypes(hObj, userName, fixdtString)`

Registers the specified user-defined data type and adds it to the top of the data type list, as displayed in the **Data type** pull-down list in the Model Explorer.

- `userName` — Name of the user data type
- `builtinName` — MathWorks C/C++ data type to which `userName` is mapped
- `userHeader` — Name of the user header file that includes the definition of the user data type
- `aliasTypeObj`, `numericTypeObj`, or `fixdtString` — `Simulink.AliasType`, `Simulink.NumericType`, or `fixdt` to which `userName` is mapped

Note If a `Simulink.AliasType` or `Simulink.NumericType` object of the same name as your registered user data type is already defined in the base workspace, the definitions of the existing object and the registered user data type must be consistent or a consistency warning will be displayed.

- `moveUserDataToTop(hObj, userName)`

Moves the specified user-defined data type to the top of the data type list, as displayed in the **Data type** pull-down list in the Model Explorer.

- `moveUserDataToEnd(hObj, userName)`

Moves the specified user-defined data type to the end of the data type list, as displayed in the **Data type** pull-down list in the Model Explorer.

- `removeUserData(hObj, userName)`

Removes the specified user-defined data type from the data type list.

Your instance of the `sl_customization` function should use these methods to register user data types for your Simulink installation.

The Simulink software reads the `sl_customization.m` file when it starts. If you subsequently change the file, to use the changes you must restart your Simulink session or enter the following command at the MATLAB command line:

```
sl_refresh_customizations
```

User Data Type Customization Using `sl_customization.m`

The `sl_customization.m` file shown in `sl_customization.m` for User Data Type Customizations on page 8-38 uses the following methods:

- `addUserDataTypes` to register the user-defined data types `MyInt16`, `MyInt32`, `MyBool`, and `fixdt(1,8)`
- `moveUserDataTypesToTop` to move `MyBool` to the top of the data type list, as displayed in the **Data type** pull-down list in the Model Explorer
- `removeUserDataTypes` to remove the built-in data types `boolean` and `double` from the data type list

`sl_customization.m` for User Data Type Customizations

```
function sl_customization(cm)
% Register user customizations

% Get default (factory) customizations
hObj = cm.slDataObjectCustomizer;

% Add custom types
hObj.addUserDataTypes('MyInt16', 'int16_T', '<mytypes.h>');
hObj.addUserDataTypes('MyInt32', 'int32_T', '<mytypes.h>');
hObj.addUserDataTypes('MyBool', 'boolean_T');
hObj.addUserDataTypes('fixdt(1,8)');

% Make MyBool first in the list
hObj.moveUserDataTypesToTop('MyBool');

% Remove built-in boolean and double from the list
hObj.removeUserDataTypes('boolean');
hObj.removeUserDataTypes('double');

end
```

If you include the above file on the MATLAB path of the Simulink installation that you want to customize, the specified customizations will appear in Model Explorer. For example, you could view the customizations as follows:

- 1 Start a MATLAB session.
- 2 Open Model Explorer, for example, by entering the MATLAB command `daexplr`.
- 3 Select **Base Workspace**.
- 4 Add an mpt signal, for example, by selecting **Add > MPT Signal**.
- 5 In the right-hand pane display for the added mpt signal, examine the **Data type** drop-down list, noting the impact of the changes specified in `sl_customization.m` for User Data Type Customizations on page 8-38.

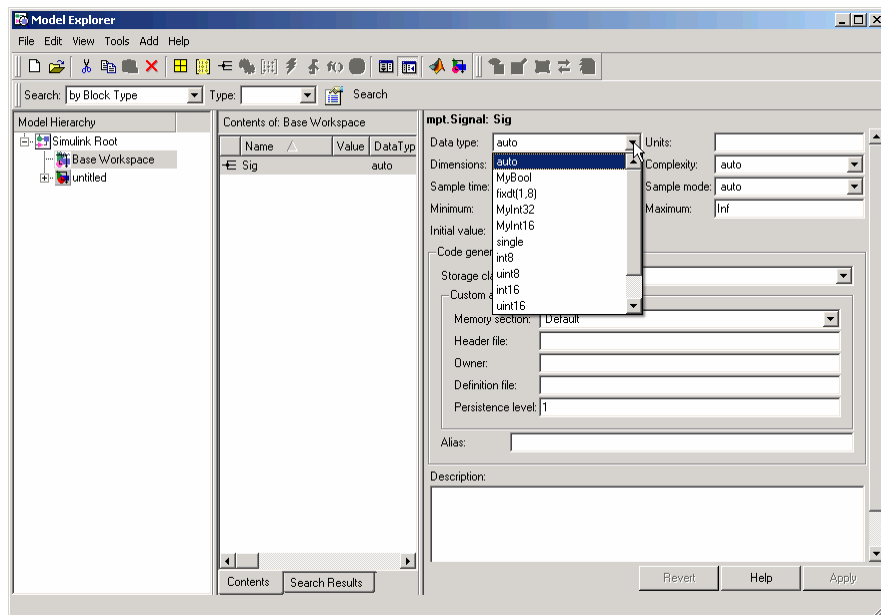

Register mpt User Object Types

- “Introduction” on page 8-40
- “Register mpt User Object Types Using `sl_customization.m`” on page 8-40

- “mpt User Object Type Customization Using `sl_customization.m`” on page 8-42

Introduction

Embedded Coder software allows you to create custom mpt object types and specify properties and property values to be associated with them (see “Create mpt Data Objects with Data Object Wizard” on page 8-63). Once created, a user object type can be applied to data objects displayed in Model Explorer. When you apply a user object type to a data object, by selecting a type name in the **User object type** pull-down list in Model Explorer, the data object is automatically populated with the properties and property values that you specified for the user object type.

To register mpt user object type customizations, use the Simulink customization file `sl_customization.m`. This file is a mechanism that allows you to use MATLAB code to perform customizations of the standard Simulink user interface. The Simulink software reads the `sl_customization.m` file, if present on the MATLAB path, when it starts and the customizations specified in the file are applied to the Simulink session. For more information on the `sl_customization.m` customization file, see “Registering Customizations”.

Register mpt User Object Types Using `sl_customization.m`

To register mpt user object type customizations, you create an instance of `sl_customization.m` and include it on the MATLAB path of the Simulink installation that you want to customize. The `sl_customization` function accepts one argument: a handle to a customization manager object. For example,

```
function sl_customization(cm)
```

As a starting point for your customizations, the `sl_customization` function must first get the default (factory) customizations, using the following assignment statement:

```
hObj = cm.slDataObjectCustomizer;
```

You then invoke methods to register your customizations. The customization manager object includes the following methods for registering mpt user object type customizations:

- `addMPTObjectType(hObj, objectTypeName, classtype, propName1, propValue1, propName2, propValue2, ...)`

`addMPTObjectType(hObj, objectTypeName, classtype, {propName1, propName2, ...}, {propValue1, propValue2, ...})`

Registers the specified user object type, along with specified values for object properties, and adds the object type to the top of the user object type list, as displayed in the **User object type** pull-down list in the Model Explorer.

- `objectTypeName` — Name of the user object type
 - `classType` — Class to which the user object type applies: 'Signal', 'Parameter', or 'Both'
 - `propName` — Name of a property of an mpt or mpt-derived data object to be populated with a corresponding `propValue` when the registered user object type is selected
 - `propValue` — Specifies the value for a corresponding `propName`
- `moveMPTObjectTypeToTop(hObj, objectTypeName)`
- Moves the specified user object type to the top of the user object type list, as displayed in the **User object type** pull-down list in the Model Explorer.
- `moveMPTObjectTypeToEnd(hObj, objectTypeName)`
- Moves the specified user object type to the end of the user object type list, as displayed in the **User object type** pull-down list in the Model Explorer.
- `removeMPTObjectType(hObj, objectTypeName)`
- Removes the specified user object type from the user object type list.

Your instance of the `s1_customization` function should use these methods to register mpt object type customizations for your Simulink installation.

The Simulink software reads the `s1_customization.m` file when it starts. If you subsequently change the file, to use the changes, you must restart your MATLAB session.

mpt User Object Type Customization Using `sl_customization.m`

The `sl_customization.m` file shown in `sl_customization.m` for mpt Object Type Customizations on page 8-42 uses the `addMPTObjectType` method to register the user signal types `EngineType` and `FuelType` for mpt objects.

`sl_customization.m` for mpt Object Type Customizations

```
function sl_customization(cm)
% Register user customizations

% Get default (factory) customizations
hObj = cm.slDataObjectCustomizer;

% Add commonly used signal types
hObj.addMPTObjectType(...
    'EngineType', 'Signal',...
    'DataType', 'uint8',...
    'Min', 0,...
    'Max', 255,...
    'DocUnits', 'm/sec');

hObj.addMPTObjectType(...
    'FuelType', 'Signal',...
    'DataType', 'int16',...
    'Min', -12,...
    'Max', 3000,...
    'DocUnits', 'mg/hr');

end
```

If you include the above file on the MATLAB path of the Simulink installation that you want to customize, the specified customizations will appear in Model Explorer. For example, you could view the customizations as follows:

- 1 Start a MATLAB session.
- 2 Open Model Explorer, for example, by entering the MATLAB command `daexplr`.
- 3 Select **Base Workspace**.

- 4** Add an mpt signal, for example, by selecting **Add > MPT Signal**.
- 5** In the right-hand pane display for the added mpt signal, examine the **User object type** drop-down list, noting the impact of the changes specified in `sl_customization.m` for mpt Object Type Customizations on page 8-42.
- 6** From the **User object type** drop-down list, select one of the registered user signal types, for example, `FuelType`, and verify that the displayed settings are consistent with the arguments specified to the `addMPTObjectType` method in `sl_customization.m`.

Data Type Replacement

In this section...
“Replace Data Types” on page 8-44
“Replace Built-In Data Type Names” on page 8-46
“Programmatically Replace Built-In Data Type Names” on page 8-51
“Replace boolean with an Integer Data Type” on page 8-52
“Data Type Replacement Limitations” on page 8-54

Replace Data Types

You can replace built-in data type names with user-defined replacement data type names in the generated code for a model.

To configure replacement data types,

- 1** In the Model Editor, set the simulation mode of the open model. From the **Simulation** menu, select Normal, Software-in-the-loop (SIL), or Processor-in-the-loop (PIL).
- 2** In the Configuration Parameters dialog box, click **Code Generation > Data Type Replacement > Replace data type names in the generated code**. A **Data type names** table appears. The table lists each Simulink built-in data type name with its corresponding code generation data type name.

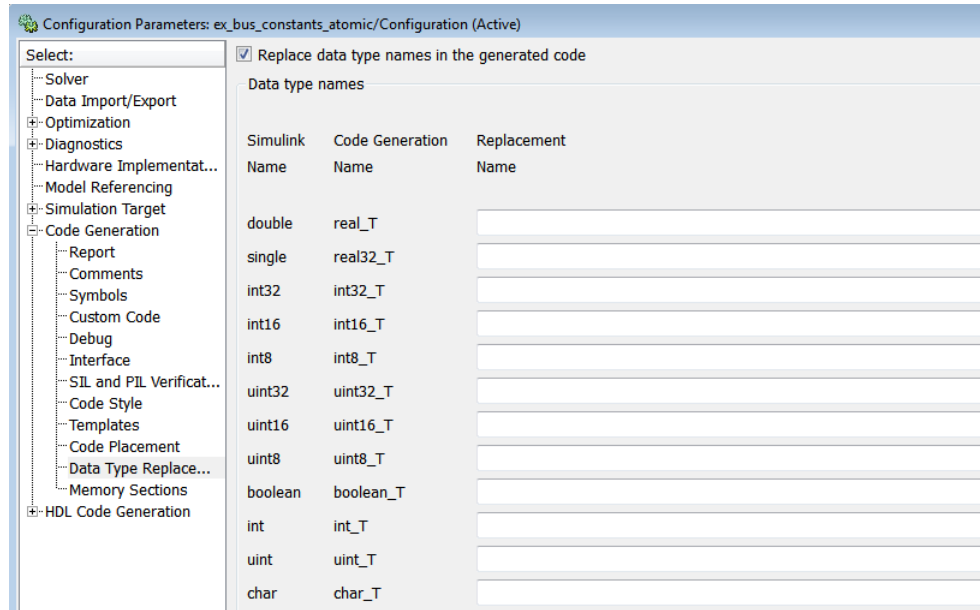

- Fill in fields in the third column with your replacement data types. Each replacement data type should be the name of a `Simulink.AliasType` object that exists in the base workspace. Replacements may be specified or not for each individual built-in type.

For each replacement data type you enter, the `BaseType` property of the associated `Simulink.AliasType` object must be consistent with the built-in data type it replaces.

- For `double`, `single`, `int32`, `int16`, `int8`, `uint32`, `uint16`, and `uint8`, the replacement data type's `BaseType` must match the built-in data type.
- For `boolean`, the replacement data type's `BaseType` must be either an 8-bit integer or an integer of the size displayed for **Number of bits: int** on the **Hardware Implementation** pane of the Configuration Parameters dialog box.
- For `int`, `uint`, and `char`, the replacement data type's size must match the size displayed for **Number of bits: int** or **Number of bits: char** on the **Hardware Implementation** pane of the Configuration Parameters dialog box.

An error occurs, if

- A replacement data type specification is inconsistent.
- The `Simulink.AliasType` object has the **Data scope** parameter set to `Exported`.

Replace Built-In Data Type Names

If your application requires you to replace built-in data type names with user-defined replacement data type names in the generated code, you can do so from the **Code Generation > Data Type Replacement** pane of the Configuration Parameters dialog box.

This pane is available for ERT target based Simulink models. In addition to providing a mechanism for mapping built-in data types to user-defined replacement data types, this feature:

- Performs consistency checks so that your specified data type replacements are consistent with your model's data types.
- Allows many-to-one data type replacement, the ability to map multiple built-in data types to one replacement data type in generated code. For example, built-in data types `uint8` and `boolean` could both be replaced in your generated code by a data type `U8` that you have previously defined.

Note For limitations that apply, see “Data Type Replacement Limitations” on page 8-54.

If you select **Replace data type names in the generated code**, the **Data type names** table is displayed.

The table **Data type names** lists each Simulink built-in data type name along with its code generation data type name. Selectively fill in fields in the third column with your replacement data types. Each replacement data type should be the name of a `Simulink.AliasType` object that exists in the base workspace. Replacements may be specified or not for each individual built-in type. For each replacement data type entered, the `BaseType` property of the associated `Simulink.AliasType` object must be consistent with the built-in data type it replaces.

- For `double`, `single`, `int32`, `int16`, `int8`, `uint32`, `uint16`, `uint8`, the replacement data type's `BaseType` must match the built-in data type.
- For `boolean`, the replacement data type's `BaseType` must be either an 8-bit integer or an integer of the size displayed for **Number of bits: int** on the **Hardware Implementation** pane of the Configuration Parameters dialog box.
- For `int`, `uint`, and `char`, the replacement data type's size must match the size displayed for **Number of bits: int** or **Number of bits: char** on the **Hardware Implementation** pane of the Configuration Parameters dialog box.

An error occurs if a replacement data type specification is inconsistent.

Note It is not recommended to use data type replacement to work around data type checking. You should not intentionally replace a data type with a type that has inconsistent characteristics, such as replacing `real_T` with a type name that maps to a single-precision data type (inconsistent size). Remapping to inconsistent types might introduce significant numerical differences, relative to simulation results, and erroneous behavior. Examples of inconsistencies include:

- Floating-point precision differences, due to the floating-point number representation and arithmetic unit on the target processor using a smaller number of bits.
- Literal values and tolerances, calculated and used during simulation and incorporated into generated code, being inconsistent with the actual data types used on the target system.
- Algorithm convergence and run-time library behavior observed during simulation not being representative of the target system.

For example, suppose that you have previously defined the following replacement data types, which exist as `Simulink.AliasType` objects in the base workspace:

User-Defined Name	Description
FLOAT64	64-bit floating point
FLOAT32	32-bit floating point
S32	32-bit integer
S16	16-bit integer
S8	8-bit integer
U32	Unsigned 32-bit integer
U16	Unsigned 16-bit integer
U8	Unsigned 8-bit integer
CHAR	Character data

You can fill in the **Data Type Replacement** pane with a one-to-one replacement mapping, as follows:

Code Generation

SIL and PIL Verification | Code Style | Templates | Code Placement | **Data Type Replacement**

Replace data type names in the generated code

Data type names

Simulink Name	Code Generation Name	Replacement Name
double	real_T	FLOAT64
single	real32_T	FLOAT32
int32	int32_T	S32
int16	int16_T	S16
int8	int8_T	S8
uint32	uint32_T	U32
uint16	uint16_T	U16
uint8	uint8_T	U8
boolean	boolean_T	
int	int_T	
uint	uint_T	
char	char_T	CHAR

You can also apply a many-to-one data type replacement mapping. For example, in the following display:

- `int32` and `int` are replaced with user type `S32`
- `uint32` and `uint` are replaced with user type `U32`
- `uint8` and `boolean` are replaced with user type `U8`

Note Many-to-one data type replacement does not support the `char` (`char_T`) built-in data type. Use `char` only in one-to-one data type replacements.

Code Generation

SIL and PIL Verification | Code Style | Templates | Code Placement | **Data Type Replacement**

Replace data type names in the generated code

Data type names

Simulink Name	Code Generation Name	Replacement Name
double	real_T	
single	real32_T	
int32	int32_T	S32
int16	int16_T	
int8	int8_T	
uint32	uint32_T	U32
uint16	uint16_T	
uint8	uint8_T	U8
boolean	boolean_T	U8
int	int_T	S32
uint	uint_T	U32
char	char_T	

The user-defined replacement types you specify will appear in your model's generated code in place of the corresponding built-in data types. For example, if you specify user-defined data type `FLOAT64` to replace built-in data type `real_T` (`double`), then the original generated code shown in Generated Code with `real_T` Built-In Data Type on page 8-51 will become the modified

generated code shown in Generated Code with FLOAT64 Replacement Data Type on page 8-51.

Generated Code with `real_T` Built-In Data Type

```

...
/* Model initialize function */
void sinwave_initialize(void)
{
...
    {real_T *dwork_ptr = (real_T *) &sinwave_DWork.lastSin;
...
}
...

```

Generated Code with `FLOAT64` Replacement Data Type

```

...
/* Model initialize function */
void sinwave_initialize(void)
{
...
    {FLOAT64 *dwork_ptr = (FLOAT64 *) &sinwave_DWork.lastSin;
...
}
...

```

Programmatically Replace Built-In Data Type Names

To replace the built-in data type names for your model, modify the `ReplacementTypes` property, which is managed as a structure. The following lines of example code show how you can modify the `ReplacementTypes` property to replace the built-in data type names `int8`, `uint8`, and `boolean` with user-defined data type names `my_T_S8`, `my_T_U8`, and `my_T_BOOL`, respectively.

```

model = bdroot;
cs = getActiveConfigSet(model);
set_param(cs, 'EnableUserReplacementTypes', 'on');

struc = get_param(cs, 'ReplacementTypes');
struc.int8 = 'my_T_S8';
struc.uint8 = 'my_T_U8';
struc.boolean = 'my_T_BOOL';

```

```
set_param(cs, 'ReplacementTypes', struc);
```

Replace `boolean` with an Integer Data Type

Using data type replacement, you can replace the `boolean` built-in data type with an integer type in the generated code. The integer type might improve the performance of the generated code on your production hardware:

- `int8`
- `uint8`
- `intn`

where n is 8, 16, or 32, matching the integer word size for the production hardware (for example, `int32` for 32-bit hardware).

For example, to map `boolean` to the `int32` data type, perform the following steps.

- 1** Define a `Simulink.AliasType` object with a base type of `int32`:

```
mybool = Simulink.AliasType;  
mybool.BaseType = 'int32';
```

- 2** Open an ERT-based model. In the **Data Type Replacement** pane of the Configuration Parameters dialog box, map `boolean` (`boolean_T`) to the replacement data type `mybool`.

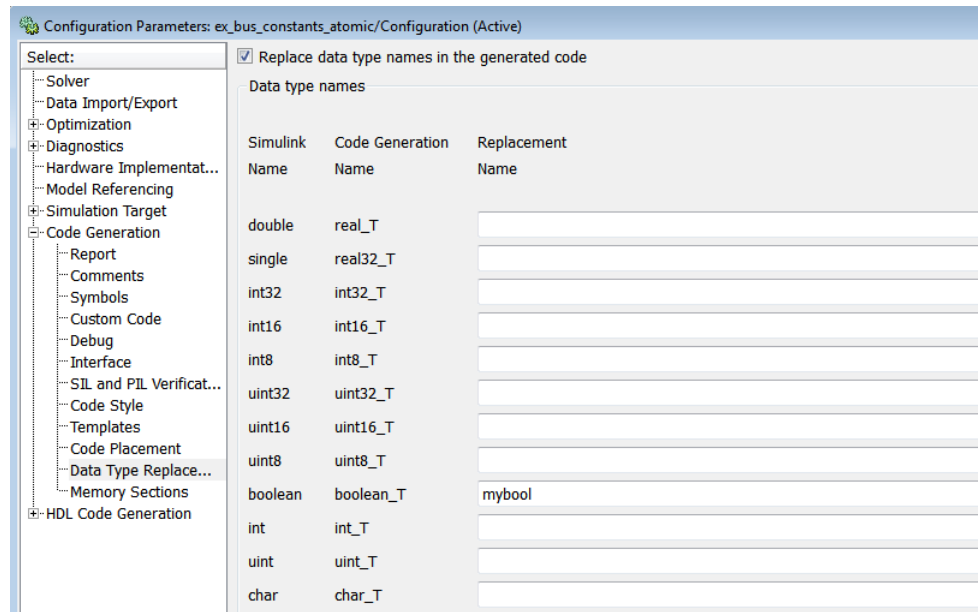

In the resulting generated code, `boolean` is replaced with `mybool`. For example, `rtwtypes.h` contains:

```
/* Generic type definitions ... */
...
typedef int boolean_T;
...
/* Define RTW replacement data types. */
typedef boolean_T mybool; /* User defined replacement datatype for boolean_T */
```

Boolean data in the generated code is declared with `mybool`. For example, given a model with a Boolean output `Out1`, an `Out1` declaration such as

```
boolean_T Out1; /* '<Root>/Out1' */
```

instead is generated in `model.h` as

```
mybool Out1; /* '<Root>/Out1' */
```

Data Type Replacement Limitations

- Data type replacements are ignored during code generation for a model unless the simulation mode of the model is set to **Normal**, **Software-in-the-Loop (SIL)**, or **Processor-in-the-Loop (PIL)**. Set the simulation mode from the **Simulation** menu in the Model Editor.
- Data type replacement does not support multiple levels of mapping. Each replacement data type name maps directly to one or more built-in data types.
- Data type replacement is not supported for simulation target code generation for referenced models.
- Data type replacement is not supported if the **Classic call interface** option is selected for your model.
- Data type replacement occurs during code generation for `.c`, `.cpp`, and `.h` files generated in build directories (including top and referenced model build directories) and in the `_sharedutils` directory. *Exceptions* are as follows:

```
rtwtypes.h
model_sf.c or .cpp (ERT S-function wrapper)
model_dt.h (C header file supporting external mode)
model_capi.c or .cpp
model_capi.h
```

- Data type replacement is not supported for complex data types.
- Many-to-one data type replacement is not supported for the `char` built-in data type. Attempting to use `char` as part of a many-to-one mapping to a user-defined data type introduces a violation of the MISRA C specification. Specifically, if `char` (`char_T`) and either `int8` (`int8_T`) or `uint8` (`uint8_T`) are mapped to the same user replacement type, the result is a MISRA C violation. Additionally, if you try to generate C++ code, invalid implicit type casts are made and compile-time errors may result. Use `char` only in one-to-one data type replacements.
- For ERT S-functions, you can replace the `boolean` built-in data type with only an 8-bit integer, `int8` or `uint8`.

Data Definition and Declaration Management

In this section...

“Overview of Data Dictionary” on page 8-55

“Create Simulink and mpt Data Objects” on page 8-56

“Create a Data Dictionary for a Model” on page 8-70

“Define Global Data Objects in Separate File” on page 8-77

“Define Global Data Objects in Separate Files” on page 8-79

“Save and Load Data Objects” on page 8-79

“Apply Naming Rules to Identifiers Globally” on page 8-79

Overview of Data Dictionary

A data dictionary contains the parameters and signals that the source code uses, and a description of their properties. The data dictionary that is created for Simulink and Stateflow models is called the code generation data dictionary. (You can use the data dictionary for simulation. This does not require that you have a Embedded Coder license.) The dictionary is the total number of data objects that appear in the middle pane of the Model Explorer. These data objects also appear in the MATLAB workspace. The procedure described in this chapter allows you to create or edit the dictionary. The procedure allows you to control property values for each data object. This, in turn, determines how each parameter and signal is defined and declared in the automatically generated code.

The values of data object properties are used to determine where the code generator places a parameter or signal in the generated file. This is because some property values are associated with different template symbols. The location of a symbol in a template determines where the associated parameter or signal is located in the generated file. For details about templates and symbols, see “Customize Code Organization and Format” on page 15-28.

It is helpful to define terms you will see when managing the dictionary, especially when you view them using the Model Explorer. The Simulink software uses a hierarchy of terms that are drawn from object-oriented

programming. For details, see “Data Objects” in the Simulink documentation. The sketch below summarizes this hierarchy.

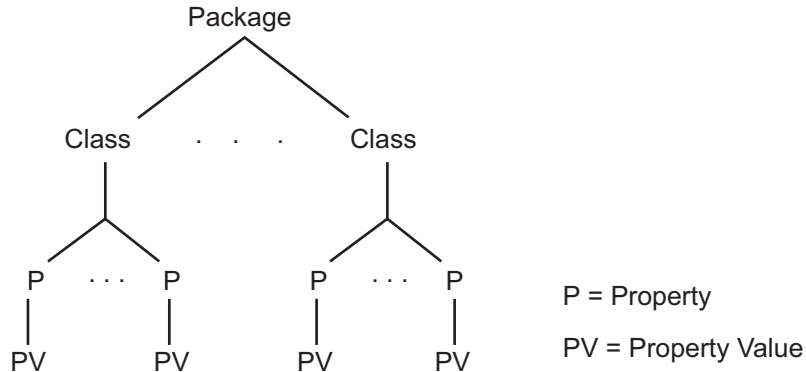

Simulink or `mpt` is the package. Parameter and Signal are two classes in each of these packages. Each class has a number of properties associated with it. Sometimes properties are called *attributes*. Data objects (the parameters and signals) are the instances of a `package.class` that make up the data dictionary. Parameter data objects have a set of properties. Signal data objects have a different set of properties than that for parameters. For each data object, each property in the set has its own property *value* that must be specified in the dictionary.

Create Simulink and `mpt` Data Objects

- “Ways to Create Data Objects” on page 8-56
- “Create Data Objects with Data Object Wizard” on page 8-57
- “Create `mpt` Data Objects with Data Object Wizard” on page 8-63
- “Simulink and `mpt` Data Object Comparison” on page 8-64
- “Create Data Objects from External Data Dictionary” on page 8-68

Ways to Create Data Objects

The Embedded Coder software provides the `mpt` (module packaging tool) data object, which contains the properties of Simulink data objects plus properties

that provide additional control over module packaging. For a comparison of the properties of Simulink and `mpt` data objects, see “Simulink and `mpt` Data Object Comparison” on page 8-64.

There are different ways of creating Simulink and `mpt` data objects for a data dictionary.

- One-by-one, either using the MATLAB command line or using the Model Explorer **Add** menu and selecting **Simulink Parameter**, **Simulink Signal**, **MPT Parameter**, or **MPT Signal**. For more information, see “Data Objects” in the Simulink documentation.
- Together, invoking Data Object Wizard for an existing model. For more information and examples, see “Data Object Wizard” in the Simulink documentation and “Create `mpt` Data Objects with Data Object Wizard” on page 8-63.
- Creating data objects based on an external data dictionary. You can do this manually item by item, or together using a script. For more information, see “Create Data Objects from External Data Dictionary” on page 8-68.

The following sections illustrate how to create Simulink and `mpt` data objects and compares their properties as data types.

Create Data Objects with Data Object Wizard

You can use Data Object Wizard to create data objects for your model (see “Data Object Wizard” in the Simulink documentation).

Data Object Wizard is especially useful for creating multiple data objects for

- Existing models that do not currently use data objects.
- Existing models to which you have added signals or parameters and therefore you need to create more data objects.

Create Data Objects. This procedure creates Simulink data objects using Data Object Wizard.

- 1 Open the model whose data objects you want to be in the data dictionary. For example, open `rtwdemo_mpf` (which is located in `toolbox/rtw/rtwdemos`).

- 2 Open Data Object Wizard by entering `dataobjectwizard` at the MATLAB command line or by selecting **Data Object Wizard** from the **Tools** menu of your model. The Data Object Wizard dialog box appears:

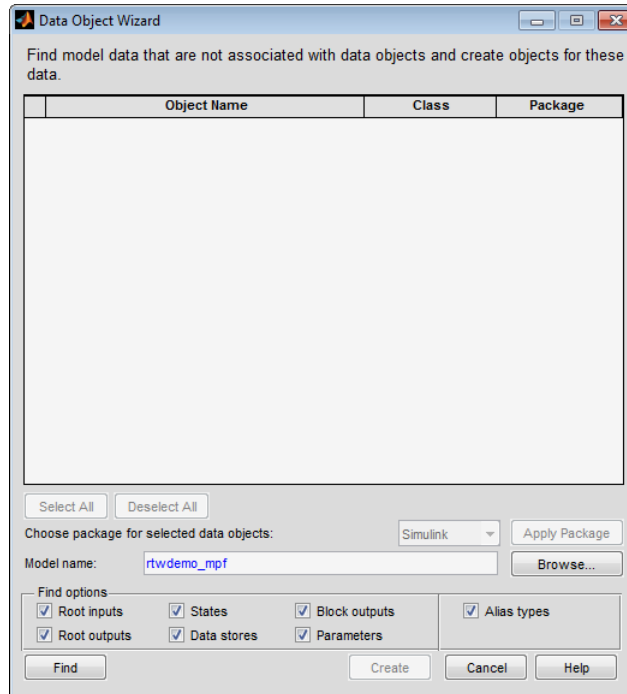

The **Model name** field displays the name of the model. You could specify a different model by editing the field or by selecting the model using the adjacent **Browse** button. When the **Model name** field is nonempty, the **Find** button is enabled.

- 3 In the **Find options** pane, select the desired check boxes. For descriptions of each check box, see “Data Object Wizard” in the Simulink documentation. Be sure to check the **Alias types** option. This finds user-registered data types in the `sl_customization.m` file plus data type replacements specified for the model in the **Data Type Replacement** pane of the Configuration Parameters dialog box. The Data Object Wizard can create `Simulink.AliasType` objects from these.

4 Click the **Find** button. The model's potential data objects appear that are not yet in the code generation data dictionary, as shown below. This includes the model's signals (root inputs, root outputs, and block outputs), discrete states, data stores, and parameters, depending on:

- The check boxes you selected in the previous step
- The constraint mentioned in the note above

Data Object Wizard finds only those signals, parameters, data stores, and states whose storage class is set to Auto. The Wizard lists each data store and discrete state that it finds as a signal class.

5 Click **Select All**. Notice in the **Choose package for selected data objects** field that Simulink, the default, is selected. Therefore, the data objects are associated with the Simulink package, as shown below.

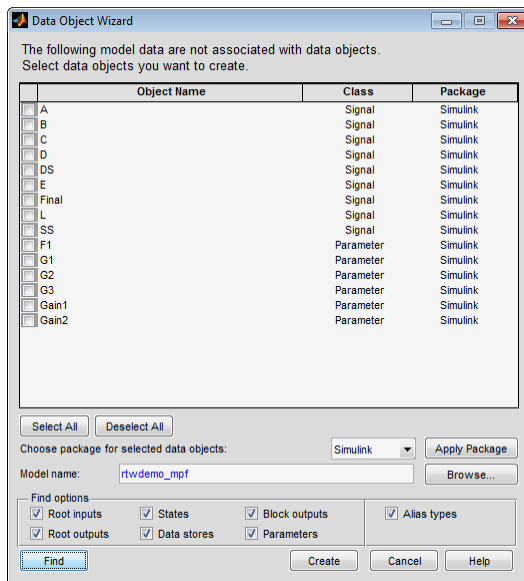

6 Click **Create**. The data objects are added to the MATLAB workspace, and they disappear from Data Object Wizard.

7 Click **Cancel**. The Data Object Wizard dialog box disappears.

Now you can set property values for the data objects.

Set Property Values for Data Objects. Most of the property values of data objects are supplied by defaults. A few are from the model. Note that for Simulink data objects, the default storage class is Auto.

- 1 Type `daexplr` on the MATLAB command line, and press **Enter**. The Model Explorer appears.
- 2 In the Model Hierarchy (left) pane, select **Base Workspace**. The Simulink data objects in the code generation data dictionary appear in the **Contents** (middle) pane, as shown below.

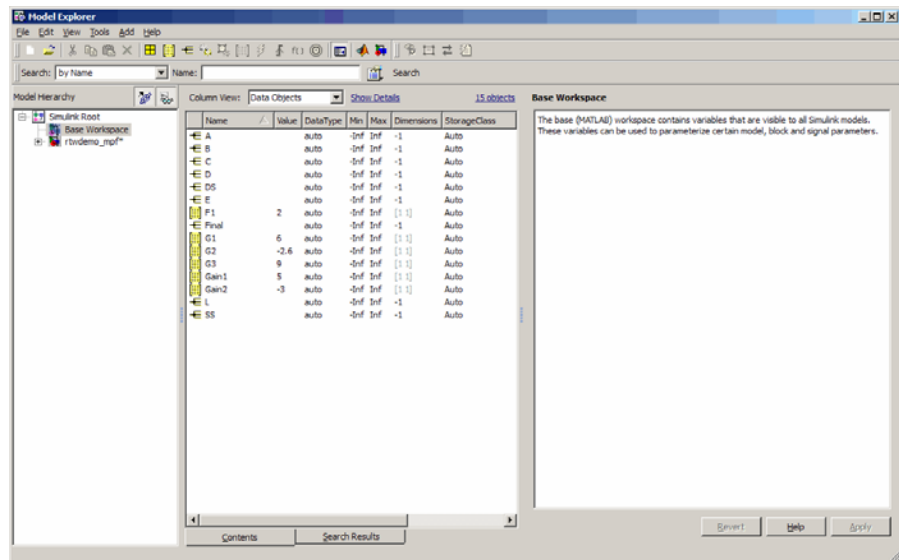

If the objects that you see do not appear in the order shown, click the **Name** column header in the middle pane to sort the objects in ascending order by name.

- 3** To see the properties of a Simulink data object, select a data object in the middle pane. The right pane displays the property names for that object. These property names also appear as column headings in the middle pane. For example, if you select signal data object A in the middle pane, the Model Explorer looks like this:

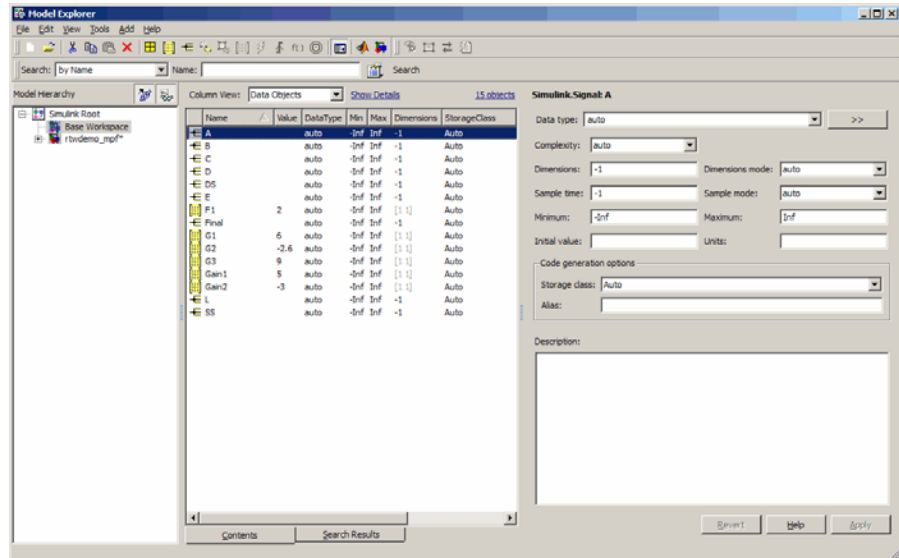

- 4 You can change the values specified for the properties of the selected object. For example, with A selected, change its **StorageClass** property from Auto to Default (Custom), then click **Apply**. The property changes as shown below:

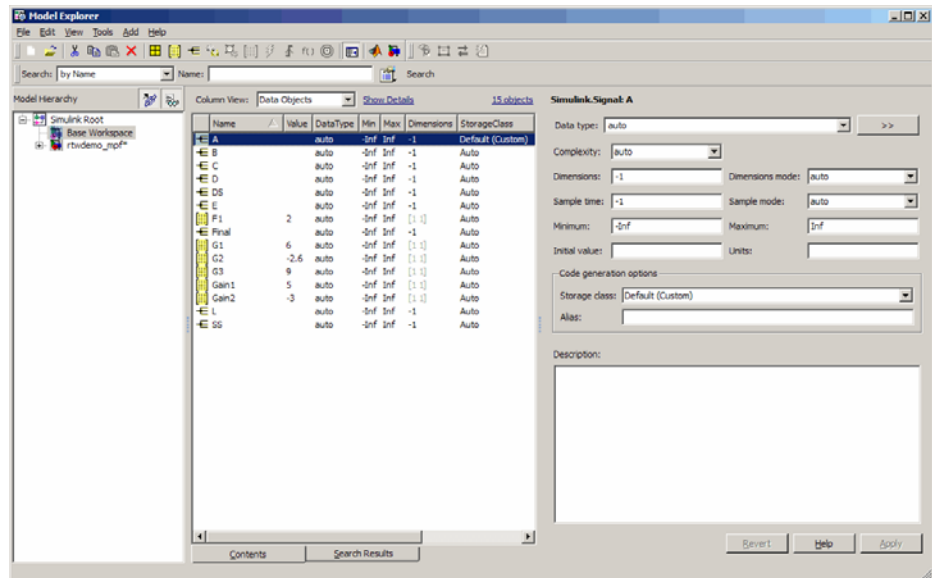

You can use Control-Right-Click to select multiple objects in the center pane, then edit a property value. The wizard applies the new value to the selected objects. For descriptions of object properties and their values, see Parameter and Signal Property Values on page 9-3.

Generate and Inspect Code. Data objects for the model are in the code generation data dictionary. You have specified property values for each data object's properties. Now you generate and inspect the source code, to see if it needs correction or modification. If it does, you can change property values and regenerate the code until it is what you want.

- 1 In the Configuration Parameters dialog box, click **Code Generation** in the left pane.
- 2 In the **Report** pane, select the **Create code generation report** check box.

Note When you select the **Create code generation report** check box, the code generation software automatically selects two check boxes on the pane: **Launch report automatically** and **Code-to-model**. For large models, you may find that HTML report generation (step 4 below) takes longer than you want. In this case, consider clearing the **Code-to-model** check box (and the **Model-to-code** check box if selected). The report will be generated faster.

- 3** In the **Code Generation** pane, select the **Generate code only** check box. The **Build** button changes to **Generate code**.

Note The generate code process generates the `.c` / `.cpp` and `.h` files. The build process adds compiling and linking to generate the executable. For details on build, see “How Executable Programs Are Built From Models” in the Simulink Coder documentation.

- 4** Click the **Generate code** button. After a moment, the HTML code generation report appears, listing the generated files on the left pane.
- 5** Select and review files in the HTML code generation report. See “Traceability in Code Generation Report” on page 18-4 for more information.

Create mpt Data Objects with Data Object Wizard

Create mpt data objects using Data Object Wizard the same way you did for Simulink data objects, as explained in “Create Data Objects with Data Object Wizard” on page 8-57, except select mpt as the package instead of Simulink.

Set the property values for the mpt data objects the same way you set them for Simulink data objects, as explained in “Set Property Values for Data Objects” on page 8-60, with the following exceptions:

- Accept the default custom storage class for mpt data objects, `Global(Custom)`
- For data objects A and F1, type `mydefinitionfile` in the **Definition file** field on the Model Explorer.

Then generate and inspect the code.

Note The **Alias** field is related to “Apply Naming Rules to Identifiers Globally” on page 8-79.

Simulink and mpt Data Object Comparison

The mpt data object contains the properties of Simulink data objects plus properties that provide additional control over module packaging. The differences between Simulink and mpt data objects can be illustrated by comparing

- “Signal and Parameter Properties” on page 8-65
- “Configuration Parameters” on page 8-66
- “Generated Code” on page 8-67

Key differences include the following:

- Different custom storage classes displayed in the Model Explorer for mpt data objects provide more control over the appearance of the generated code.
- Additional custom attributes (owner, definition file, persistence level, memory section) for mpt data objects provide more control over data packaging in the generated code.
- On the **Comments** pane of the Configuration Parameters dialog box, the **Custom comments (MPT objects only)** option allows you to add a comment just above a signal or parameter’s identifier in the generated code.
- On the **Code Placement** pane of the Configuration Parameters dialog box, in the **Global data placement (MPT data objects only)** subpane:
 - The **Signal display level** parameter allows you to specify whether or not the code generator declares a signal data object as global data
 - The **Parameter tune level** parameter allows you to specify whether or not the code generator declares a parameter data object as tunable global data

Signal and Parameter Properties. The properties that appear in Model Explorer when `mpt` is the package include the properties that appear when `Simulink` is the package plus additional properties. Notice this by comparing the next two figures. (For descriptions of properties in Model Explorer, see Parameter and Signal Property Values on page 9-3.)

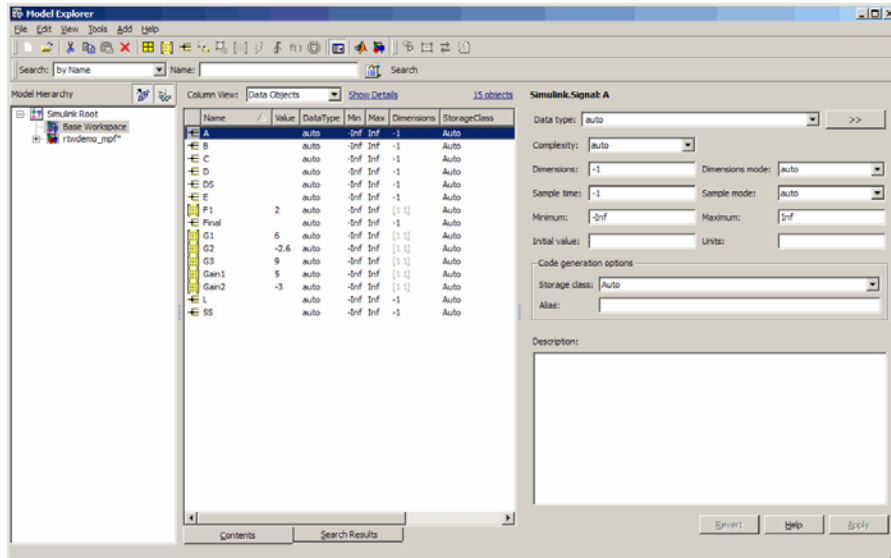

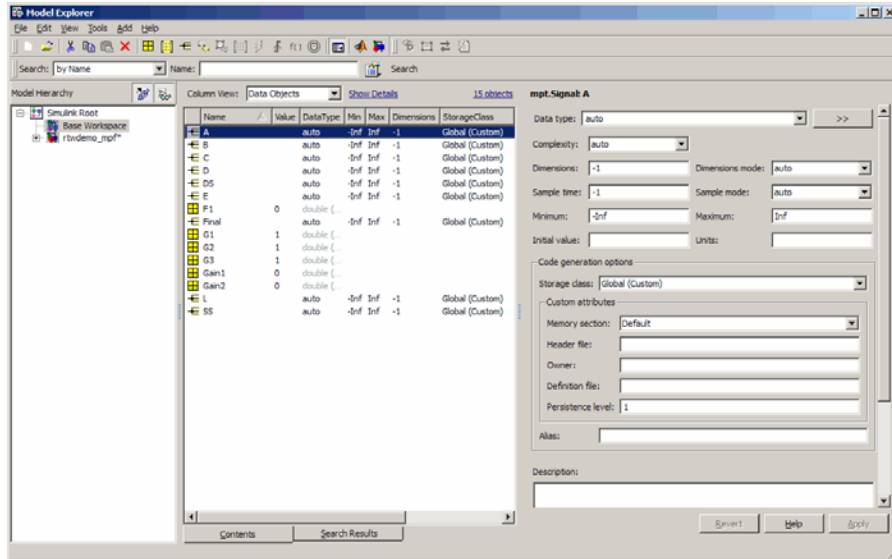

Configuration Parameters. The following configuration parameters relate to module packaging features. These parameters are available in the Configuration Parameters dialog box and Model Explorer when the system target file selected for a Simulink model is `ert.tlc` (or a system target file derived from an `ert.tlc`):

- **Custom comments (MPT objects only)** option on the **Code Generation > Comments** pane
- In the **Global data placement (MPT data objects only)** subpane on the **Code Generation > Code Placement** pane:
 - **Signal display level** parameter
 - **Parameter tune level** parameter

Generated Code. In the example used in “Set Property Values for Data Objects” on page 8-60, you selected **Default (Custom)** in the **Storage class** field for signal A and parameter F1. You selected the default **Auto** in the **Storage class** field for the remaining data objects. But for the mpt data objects you used the default **Global (Custom)** in the **Storage class** field. When you generated code, these selections resulted in the definitions and declarations shown in the table below.

Simulink Data Object with Auto Storage Class	Simulink Data Object with Default (Custom) Storage Class	mpt Data Object with Global (Custom) Storage Class and Definition File Named mydefinitionfile
<pre>In rtwdemo_mpf.c: /* For signal A */ ExternalInputs rtU; /* For parameter F1 */ if(rtU.A * 2.0 > 10.0) {... In rtwdemo_mpf.h: /* For signal A */ typedef struct { real_T A; } ExternalInputs; extern ExternalInputs rtU;</pre>	<pre>In global.c: real_T A; real_T F1 = 2.0; In global.h: extern real_T A; extern real_T F1;</pre>	<pre>In mydefinitionfile.c: real_T A; real_T F1 = 2.0; In global.h: extern real_T A; extern real_T F1;</pre>

The results shown in the second and third columns of the preceding table require the following configuration parameter adjustments on the **Code Generation > Code Placement** pane:

- Set **Data definition** to Data defined in single separate source file.
- Set **Data definition filename** to `global.c`
- Set **Data declaration** to Data declared in single separate source file.

- Set **Data definition filename** to `global.h`

See the left column of the table, which shows generated code for Simulink signal and parameter data objects, whose **Storage class** field is `Auto`. The input `A` is defined as part of the structure `rtU` as shown above. In the case of the Simulink parameter data object `F1`, since the **StorageClass** was set to `auto`, the code generator chose to include the literal value of `F1` in the generated code. `F1` is a constant in the Stateflow diagram whose value is initialized as `2.0`:

```
if(rtU.A * 2.0 > 10.0) { ...
```

For more details, see “Introduction to Custom Storage Classes” on page 10-2 and “Summary of Signal Storage Class Options” in the Simulink Coder documentation.

See the middle column of the table. The Simulink data objects whose **Storage class** is not `Auto` are defined in a definition statement in the global source file (`global.c`) and declared in a declaration statement in the global header file (`global.h`).

In the right column, Simulink data objects whose **Storage class** is not `Auto` are defined in `mydefinitionfile`, as you specified. The declarations for those objects are in the global header file.

Create Data Objects from External Data Dictionary

This procedure creates data objects based on an external data dictionary (such as a Microsoft® Excel® file). You can do this manually or automatically.

Create Data Objects Manually. You can create data objects (and their properties) one-by-one, based on an external data dictionary, as follows:

- 1** Open the external file that contains the data (such as a spreadsheet or database file).
- 2** Determine the data in this file that correspond to the parameters and signals in the model. In the code generation data dictionary, parameters in the external file belong to the Simulink parameter class and signals belong to the Simulink signal class.
- 3** On the MATLAB command line, type `daexplr` and press **Enter**. The Model Explorer appears.
- 4** On the **Model Hierarchy** (left) pane, expand **Simulink Root**, and select **Base Workspace**.
- 5** On the **Add** menu, select **MPT Parameter** or **Simulink Parameter**. The default name `Param` appears in the **Contents of** (middle) pane.
- 6** Double-click `Param` and rename this data object as desired.
- 7** Repeat steps 5 and 6 for each additional data item in the external file that belongs to the `mpt.Parameter` class or `Simulink.Parameter` class.

Now you will add data items in the external file that belong to the `mpt.Signal` class or `Simulink.Signal` class.

- 8** On the **Add** menu, select **MPT Signal** or **Simulink Signal**. The default name `Sig` appears in the **Contents of** pane.
- 9** Double-click `Sig` and rename the data object as desired.
- 10** Repeat steps 8 and 9 for each additional data item in the external file that belongs to the `mpt.Signal` class or `Simulink.Signal` class.

External data items for the `mpt.Parameter` or `Simulink.Parameter` class, and the `mpt.Signal` or `Simulink.Signal` class now appear in the **Contents of** pane and in the MATLAB workspace. Therefore, they have been created in the code generation data dictionary.

Note The property *values* for these data objects are supplied by default.

Create Data Objects Automatically. You can create data objects (and their properties) based on an external data dictionary by creating and running a .m file. This file contains the same MATLAB commands you could use for creating data objects one-by-one on the command line, as explained in “Data Objects” in the Simulink documentation. But instead of using the command line, you place the MATLAB commands in the .m file for the desired data in the external file:

- 1 Create a new .m file.
- 2 Place information in the file that describes the data in the external file that you want to be data objects. For example, the following information creates two mpt data objects with the indicated properties. The first is for a parameter and the second is for a signal:

```
% Parameters
mptParCon = mpt.Parameter;
mptParCon.CoderInfo.CustomStorageClass = 'Const';
mptParCon.value = 3;
% Signals
mptSigGlb = mpt.Signal;
mptSigGlb.DataType = 'int8';
```

- 3 Run the .m file. The data objects appear in the MATLAB workspace.

Note If you want to import data from an external data dictionary, you can write functions that read the information, convert these to data objects, and load them into the MATLAB workspace. Among available MATLAB functions that you can use for this process are `xmlread`, `xmlwrite`, `xlsread`, `xlswrite`, `csvread`, `csvwrite`, `dlmread`, and `dlmwrite`.

Create a Data Dictionary for a Model

In this procedure, you create a data dictionary for a model using Data Object Wizard, inspect the data dictionary, and generate code. Definitions

for the data objects in the dictionary are generated into the model source file (`model.c`).

Use Data Object Wizard

- 1 Open the model `rtwdemo_mpf` by clicking the link or by typing `rtwdemo_mpf` in the MATLAB Command Window.

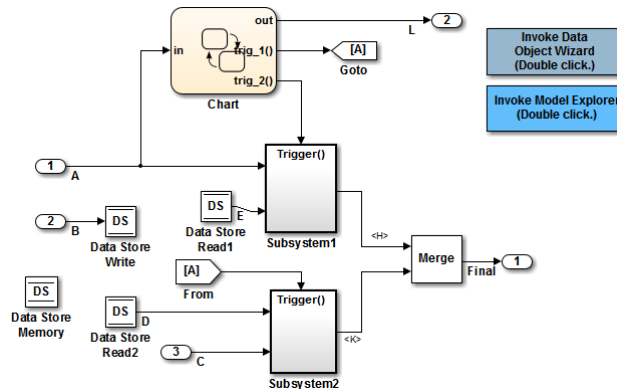

In this model,

- A, B, and C are input signals, and L and Final are output signals.
- Subsystem1 receives inputs A and E and contains constants G1 and G2. Signal E is an output from Data Store Read1.
- Subsystem2 receives inputs C and D. Signal D is an output from Data Store Read2. There is a constant in Subsystem2 named G3. Also, this subsystem has a Unit Delay block whose state name is SS.

- 2 Double-click the Stateflow chart and notice it has constants F1, Gain1, and Gain2, as shown below:

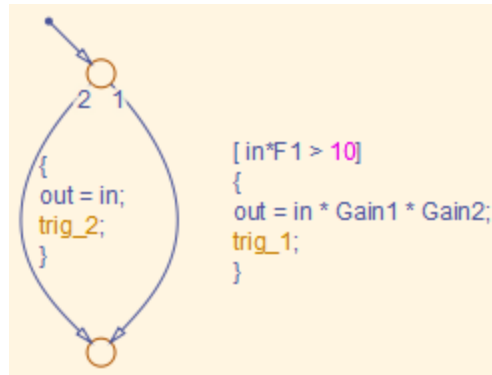

- 3 Change to a work folder that is not on an installation path and save the model in that work folder. The code generation software does not allow you to generate code from an installation folder.
- 4 Double-click the **Invoke Data Object Wizard** button on the model. Or, type `dataobjectwizard('rtwdemo_mpf')` in the MATLAB Command Window. Data Object Wizard opens and `rtwdemo_mpf` appears in the **Model name** field, as shown below.

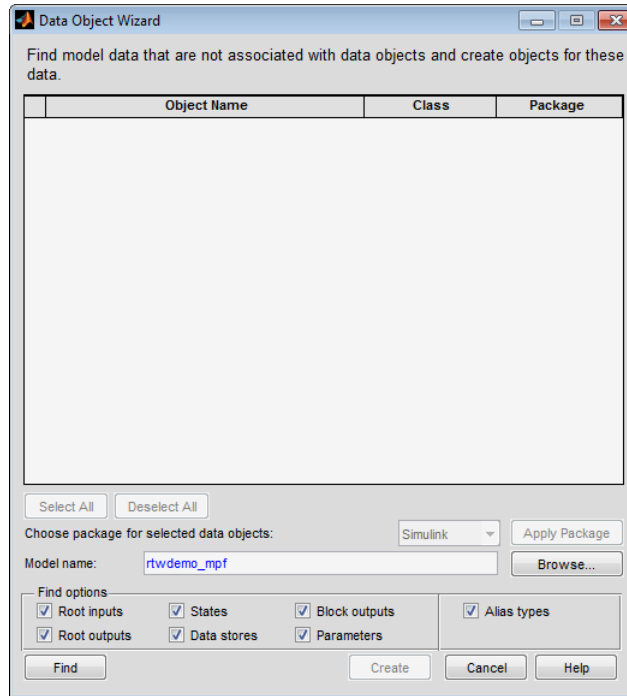

- 5 Click **Find** on Data Object Wizard. After a moment, the model's parameters and signals appear in Data Object Wizard. These "data objects" make up the data dictionary.
- 6 Click **Select All**.
- 7 In the **Choose package for selected objects** field, select `mpt`. For an explanation of "package," see "Overview of Data Dictionary" on page 8-55.

- 8 Click **Apply Package**. Data Object Wizard associates the selected data objects with the mpt package, as shown below.

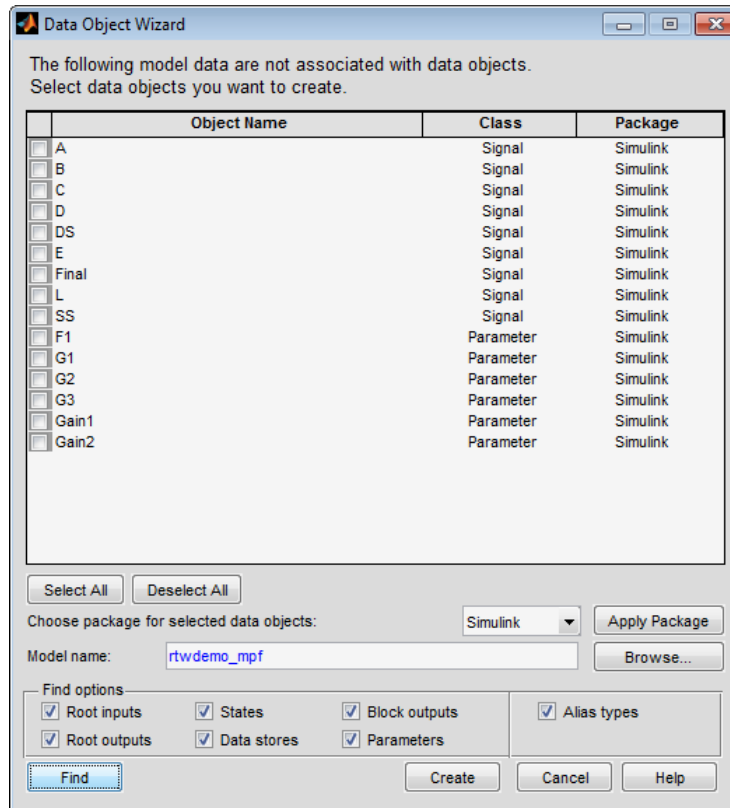

- 9** Click **Create**. Data Object Wizard creates a data dictionary, consisting of data objects for the selected parameters and signals. Data Object Wizard removes the objects from its object view. Also, the objects are added to the MATLAB workspace, as shown below.

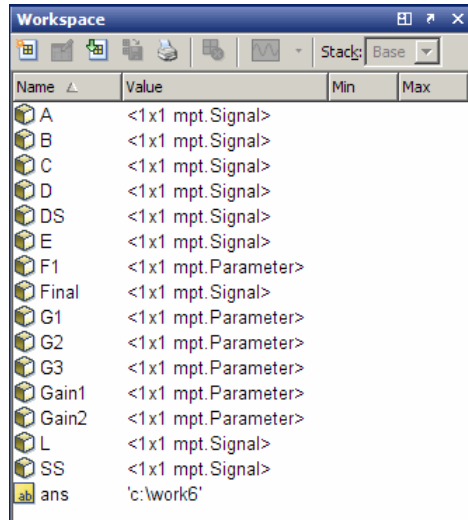

- 10** Close Data Object Wizard.

Inspect the Data Dictionary

You can verify that each data object you selected in Data Object Wizard is in the data dictionary, using the Model Explorer:

- 1** If you have not already done so, complete the steps in “Use Data Object Wizard” on page 8-71 .
- 2** Open the Model Explorer.
- 3** In the left pane, select **Base Workspace**. Notice that data objects that you placed in the data dictionary appear in the middle pane.

- 4 In the middle pane, select data objects one at a time, and notice their property values in the right pane. The figure below shows this for signal A. The data objects have default property values. Note that for an mpt data object, the default in the **Storage class** field is **Global (Custom)**. For descriptions of the properties on the Model Explorer, see “Set Property Values for Data Objects” on page 8-60.

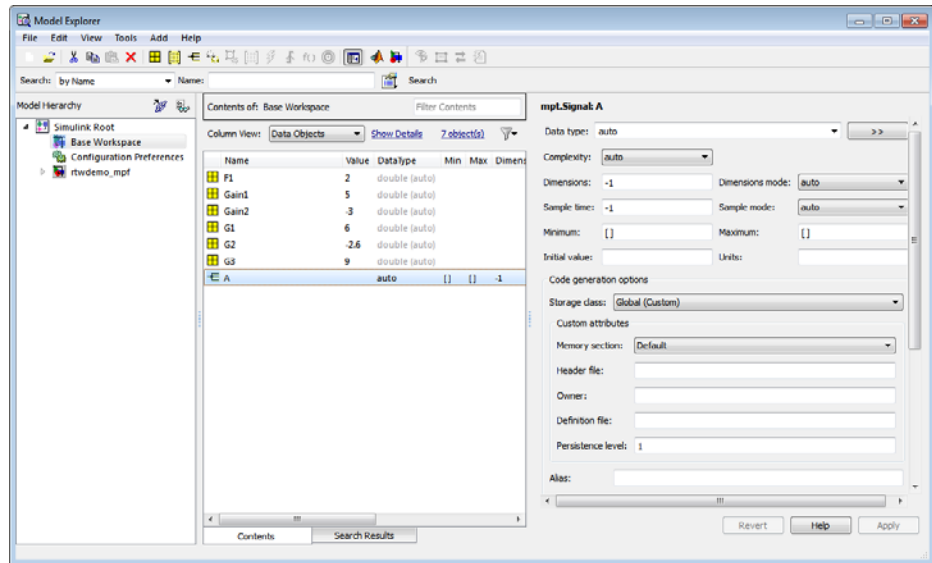

Generate and Inspect Code

- 1 If you have not already done so, complete the steps in “Use Data Object Wizard” on page 8-71 and “Inspect the Data Dictionary” on page 8-75.
- 2 In the left pane of the Model Explorer, expand the **rtwdemo_mpf** node.
- 3 In the left pane, click **Configuration (Active)**.
- 4 In the center pane, click **Code Generation**. The active configuration parameters appear in the right pane.
- 5 In the **Report** tab, select **Create code generation report**

- 6 Select the **General** tab. Select **Generate code only**, and then click **Generate code**. After a few moments, the names of the generated files are listed on the Code Generation Report on the left pane.

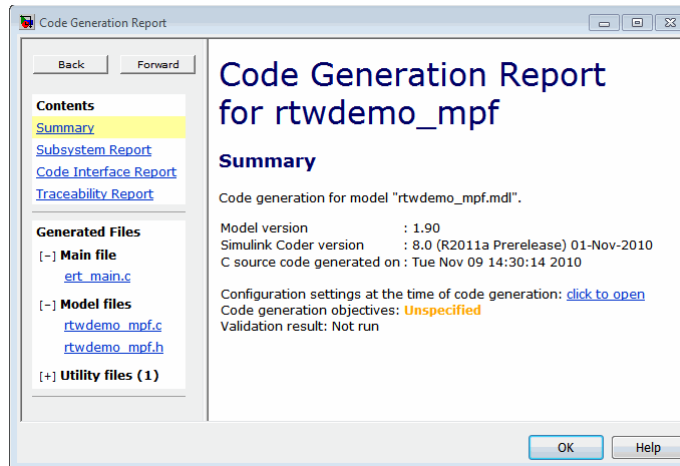

- 7 Open and inspect the content of the model source file `rtwdemo_mpf.c`. The following data objects in the data dictionary are initialized in this file.

```
real_T F1 = 2.0;
real_T G1 = 6.0;
real_T G2 = -2.6;
real_T G3 = 9.0;
real_T Gain1 = 5.0;
real_T Gain2 = -3.0;
```

Define Global Data Objects in Separate File

The previous procedure placed the model's data objects in the model source file. Now you place global data objects in a file separate from the model source file:

- 1 Configure the model's generated code to include Simulink data objects (signal and parameter) in a separate definition file. Set **Diagnostics > Data Validity > Signal resolution** to **Explicit** and **implicit**.

- 2 Specify that data be defined in a separate file. Set **Code Generation > Code Placement > Data definition** to **Data defined in single separate source file**. Accept the default for **Data definition filename**, `global.c`

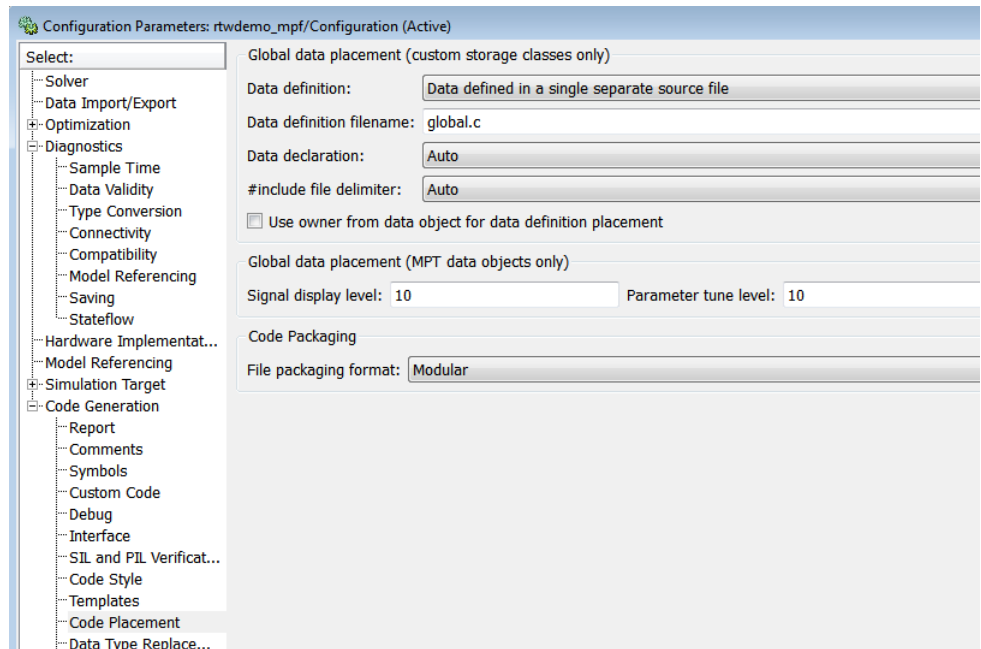

- 3 Specify that data be declared in a separate file. Set **Data declaration** to **Data declared in a single separate header file** and accept the default for **Data declaration filename**, `global.h`. Then, click **Apply**.
- 4 Click **Generate code**. Notice that the code generation report lists `global.c` and `global.h` files.
- 5 Inspect the code generation report. Notice that
 - The data objects formerly initialized in `rtwdemo_mpf.c` now are initialized in `global.c`.
 - The file `rtwdemo_mpf.c` includes `rtwdemo_mpf.h`.
 - The file `rtwdemo_mpf.h` includes `global.h`.

Define Global Data Objects in Separate Files

The previous procedure placed global data objects in a separate definition file. You named that file `global.c`. (You named the corresponding declaration file `global.h`.) MPF allows you to override this and place a specific data object in its own definition file. In the following procedure, you move the `Final` signal to a file called `finalsig.c`, and keep the other data objects defined in `global.c`:

- 1** In the Model Explorer, display the base workspace and select the `Final` signal object. The **mpt.Signal** properties appear in the right pane.
- 2** In the **Code generation options** section, type `finalsig.h` in the **Header file** text box, type `finalsig.c` in the **Definition file** text box, and click **Apply**.
- 3** On the **Code Generation > General** pane, click **Generate code**. The code generation report still lists `global.c` and `global.h`, but adds `finalsig.c` and `finalsig.h`.
- 4** Open the files to inspect them. Notice that the `Final` signal is defined in `finalsig.c`. Other data objects in the dictionary are defined in `global.c`.

Save and Load Data Objects

In a `.mat` file, you can save the set of data objects (and their properties) that you have created and load this information for later use or exchange it with another user. You can save data objects in the workspace.

Apply Naming Rules to Identifiers Globally

- “Overview” on page 8-80
- “Change Names of Identifiers” on page 8-81
- “Specify Data Object Naming Rules” on page 8-84
- “Define Rules That Change Signal Names” on page 8-85
- “Define Rules That Change Parameter Names” on page 8-85
- “Define Rules That Change `#defines`” on page 8-86

Note The capabilities described in this section apply only to mpt data objects.

Overview

Signal and parameter names appear on a Simulink model. The same names appear as data objects on the Model Explorer. By default, these names are replicated exactly in the generated code. For example, "Speed" on the model (and workspace) appears as the identifier "Speed" in the code, by default. But you can change how they appear in the code. For example, if desired, you can change "Speed" to SPEED or speed. Or, you can choose to use a different name altogether in the generated code, like MPH. The only restriction is that you follow ANSI C⁴/C++ rules for naming identifiers.

There are two ways of changing how a signal name or parameter name is represented in the generated code. You can do this *globally*, by following the procedure in this section. This procedure makes selections on the Configuration Parameters dialog box to change the names when code generation occurs, according to the same rule. Or, you can change the names *individually* by following the steps described in "Set Property Values for Data Objects" on page 8-60. The relevant field in that procedure is **Alias** on the Model Explorer.

If the **Alias** field is empty, the naming rule that you select on the Configuration Parameters dialog box applies across data objects. But if you do specify a name in the **Alias** field, this overrides the naming rule for that data object. The table below illustrates these cases. The table assumes that you selected Force lower case as the naming rule. But with the information provided, you can determine how the naming rules work for an mpt data object or a Simulink data object (Force upper case, Force lower case, or Custom M-function).

4. ANSI[®] is a registered trademark of the American National Standards Institute, Inc.

Naming Rules and Alias Override (Global Change of Force Lower Case Rule)

Name of Data Object in Model	Name in Alias Field	Package	Result in Generated Code
A		Simulink or mpt	a
A	D	Simulink or mpt	D

Change Names of Identifiers

This procedure changes the names of signal identifiers so that they are spelled with lowercase letters. A in the definition statement located in `global.c` is changed to `a`. The one exception is the `Final` signal in the `finalsig.c` file. You change this identifier name to `Final_Signal`. The names of the rest of the identifiers in the generated files remain the same:

- 1 Open the **Code Generation > Symbols** pane of the Configuration Parameters dialog.
- 2 In the **Simulink data object naming rules** section, set **Signal naming** to **Force lower case**, and click **Apply**.

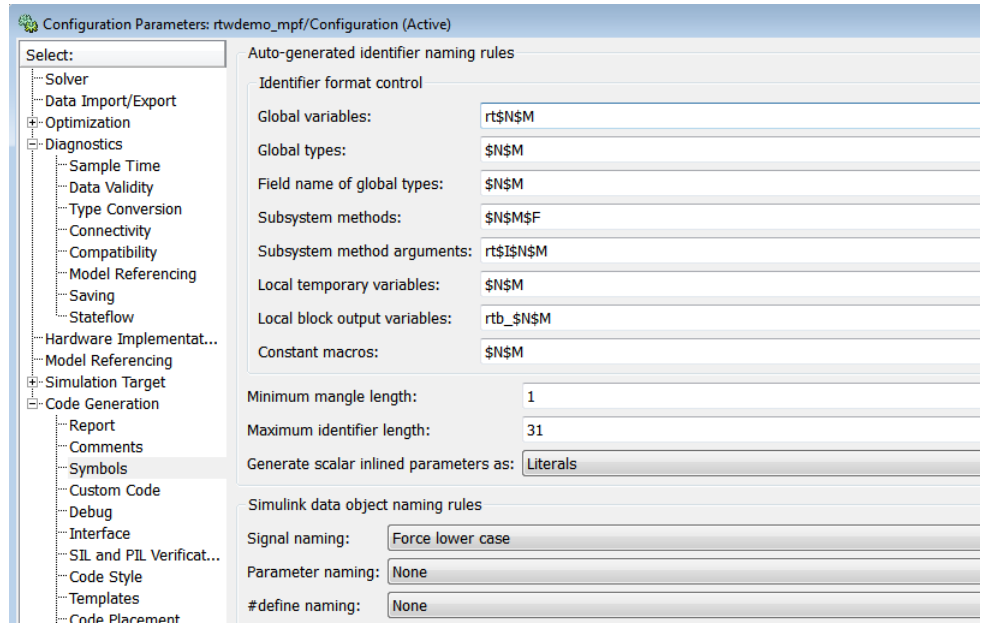

3 Display the base workspace and select Final.

4 In the right pane, type Final_Signal in the **Alias** text box, then click **Apply**.

5

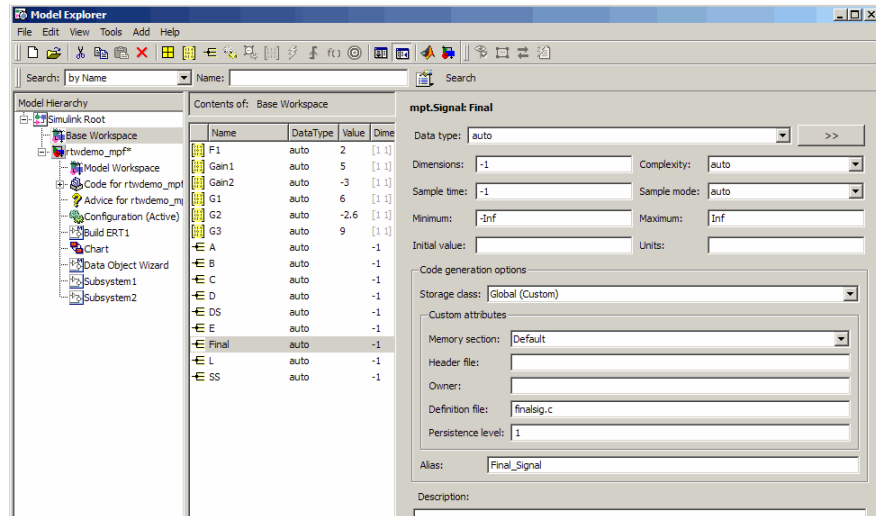

- 6** On the **Code Generation > General** pane, click **Generate code**. Now, the signal identifiers in `global.c` and `global.h` appear with lowercase letters.

```

real_T F1 = 0.0;
real_T G1 = 1.0;
real_T G2 = 1.0;
real_T G3 = 1.0;
real_T Gain1 = 0.0;
real_T Gain2 = 0.0;
real_T a;
real_T b;
real_T c;
real_T d;
real_T ds;
real_T e;
real_T l;
real_T ss;

```

The statement defining the `Final` signal in `finalsig.c` looks like this:

```
real T Final_Signal;
```

The statement declaring this identifier in `finalsig.h` looks like this:

```
extern real_T Final_Signal;
```

Specify Data Object Naming Rules

You specify Simulink data object naming rules on the **Code Generation > Symbols** pane of the Configuration Parameters dialog box. To access that pane,

- 1 Open an ERT-based model.
- 2 Open the Configuration Parameters dialog box from the **Simulation** menu or Model Explorer.
- 3 Open the **Code Generation > Symbols** pane. See the subpane **Simulink data object naming rules**.

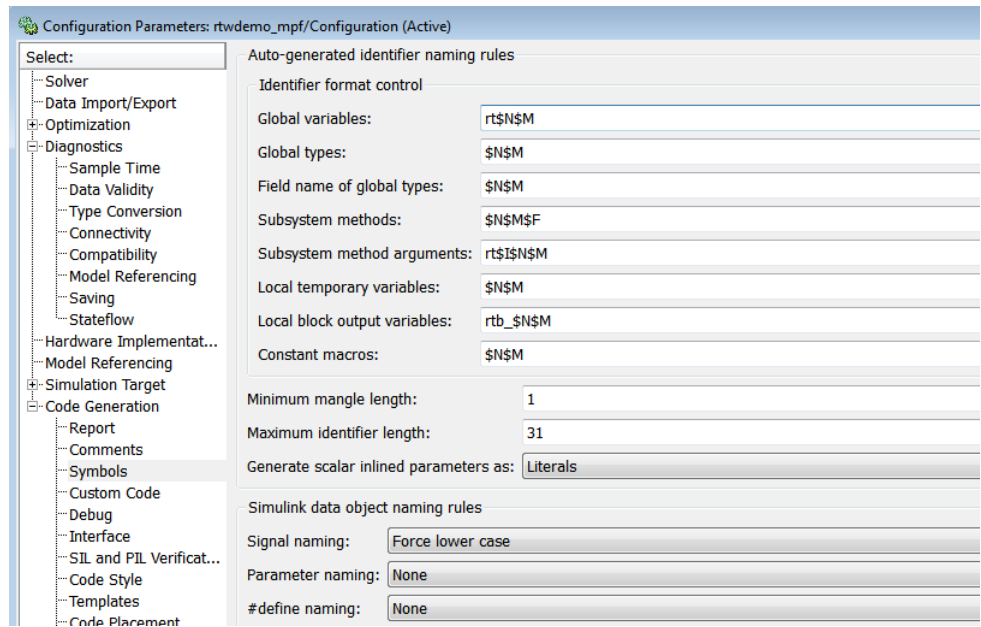

Notice the preconfigured settings on this pane. Proceed to “Create Data Types for mpt Data Objects” on page 8-35. Otherwise, follow the procedures below, as desired, to change signal names, parameter names, or parameter names that you want to use in a `#define` preprocessor directive. “Code Generation

Pane: Symbols” in the Simulink Coder documentation describes the fields on this pane and their possible settings for these procedures.

- “Define Rules That Change Signal Names” on page 8-85
- “Define Rules That Change Parameter Names” on page 8-85
- “Define Rules That Change #defines” on page 8-86

Define Rules That Change Signal Names

This procedure allows you to change a model’s signal names, using the same rule. The new names will appear as identifiers in the generated code:

- 1** In the **Signal naming** menu, click the desired selection. (“Signal naming” explains the possible selections.) The default is **None**. If you selected **Custom M-function**, go to the next step. Otherwise, click **Apply** and then generate and inspect code.
- 2** Write a MATLAB function that changes occurrences of signal names in the model to appear the way you want as identifiers in the generated code. (An example is shown in “Define Rules That Change Parameter Names” on page 8-85.)
- 3** Save the function as a `.m` file in a folder on the MATLAB path.
- 4** In the **M-function** field under **Signal naming**, type the name of the file you saved in the previous step.
- 5** Click **Apply** and then generate and inspect code.

Define Rules That Change Parameter Names

This procedure allows you to change a model’s parameter names, using the same rule. The new names will appear as identifiers in the generated code:

- 1** In the **Parameter naming** field, click the desired selection. (“Parameter naming” explains the possible selections.) The default is **None**. If you selected **Custom M-function**, go to the next step. Otherwise, click **Apply**, and proceed to “Define Rules That Change Signal Names” on page 8-85.

- 2 Write a MATLAB function that changes occurrences of parameter names in the model to appear the way you want as identifiers in the generated code. For example, the code below changes parameter names to make their first letter uppercase, and their remaining letters lowercase.

```
function
revisedName = initial_caps_only(name, object)
% INITIAL_CAPS_ONLY: User-defined naming rule causing each
% identifier in the generated code to have initial cap(s).
%
% name: name as spelled in model.
% object: the object of name; includes name's properties.
%
% revisedName: manipulated name returned to MPT for the
code.
%
%
:
revisedName = [upper(name(1)),lower(name(2:end))];
:
```

- 3 Save the function as a `.m` file in a folder on the MATLAB path.
- 4 In the **M-function** field under **Parameter naming**, type the name of the file you saved in the previous step.
- 5 Click **Apply** and then define rules applicable to signal names.

Define Rules That Change #defines

This procedure allows you to change a model's parameter names whose storage class you selected as **Define** in "Create mpt Data Objects with Data Object Wizard" on page 8-63, using the same rule. The new names will appear as identifiers in the generated code:

- 1 In **#define naming**, click the desired selection. ("#define naming" explains the possible selections.) The default is **None**. If you select **Custom M-function**, go to the next step. Otherwise, click **Apply** and proceed to "Define Rules That Change Parameter Names" on page 8-85.

- 2** Write a MATLAB function that changes occurrences of the parameter name whose storage class you specified as `Define` in “Create mpt Data Objects with Data Object Wizard” on page 8-63 so that it appears the way you want as an identifier in the generated code. (An example is shown below.)
- 3** Save the function as a `.m` file in a folder on the MATLAB path.
- 4** In the **M-function** field under **#define naming**, type the name of the file you saved in the previous step.
- 5** Click **Apply** and then define rules that change parameter names.

Module Packaging Tool (MPT) Data Objects

MPT Data Object Properties

The following table describes the properties and property values for `mpt.Parameter` and `mpt.Signal` data objects that appear in the Model Explorer.

Note You can create `mpt.Signal` and `mpt.Parameter` objects in the base MATLAB or model workspace. However, if you create the object in a model workspace, the object's storage class must be set to `auto`.

The figure below shows an example of the Model Explorer. When you select an `mpt.Parameter` or `mpt.Signal` data object in the middle pane, its properties and property values display in the rightmost pane.

In the Properties column, the table lists the properties in the order in which they appear on the Model Explorer.

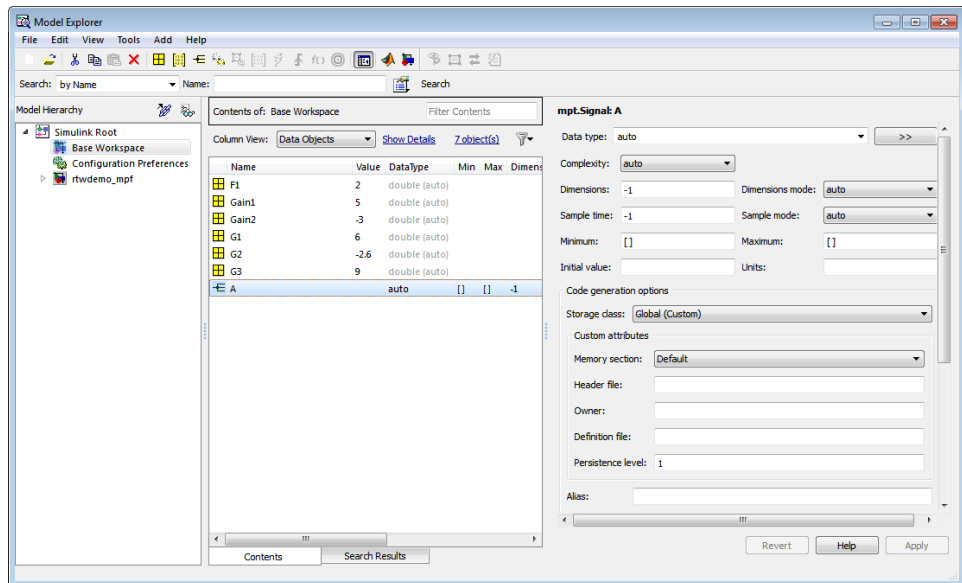

Parameter and Signal Property Values

Class: Parameter, Signal, or Both	Property	Available Property Values (* Indicates Default)	Description
Both	User object type	*auto	<p>Prenamed and predefined property sets that are registered in the <code>sl_customization.m</code> file. (See “Register mpt User Object Types” on page 8-39.) This field is active when a user object type is registered.</p> <p>Select auto if this field is available but you do not want to apply the properties of a user object type to a selected data object. The fields on the Model Explorer are populated with default values.</p>
		Listed user object type name	Select a user object type name to apply the properties and values that you associated with this name in the <code>sl_customization.m</code> file. The fields on the Model Explorer are automatically populated with those values.
Parameter	Value	*0	The data type and numeric value of the data object. For example, <code>int8(5)</code> . The numeric value is used as an initial parameter value in the generated code.
Both	Data type		Used to specify the data type for an <code>mpt.Signal</code> data object, but not for an <code>mpt.Parameter</code> data object. The data type for an <code>mpt.Parameter</code> data object is specified in the Value field above. See “Data Types” in the Simulink documentation.
Both	Units	*null	Units of measurement of the signal or parameter. (Enter text in this field.)

Parameter and Signal Property Values (Continued)

Class: Parameter, Signal, or Both	Property	Available Property Values (* Indicates Default)	Description
Both	Dimensions	* -1	The dimension of the signal or parameter. For a parameter, the dimension is derived from its value.
Both	Complexity	*auto real complex	Complexity specifies whether the signal or parameter is a real or complex number. Select auto for the code generator to decide. For a parameter, the complexity is derived from its value.
Signal	Sample time	* -1	Model or block execution rate.
Signal	Sample mode	*auto	Determines how the signal propagates through the model. Select auto for the code generator to decide.
		Sample based	The signal propagates through the model one sample at a time.
		Frame based	The signal propagates through the model in batches of samples.
Both	Minimum	*0.0	The minimum value to which the parameter or signal is expected to be bound.
		Number within the minimum range of the parameter or signal. (Based on the data type and resolution of the parameter or signal.)	

Parameter and Signal Property Values (Continued)

Class: Parameter, Signal, or Both	Property	Available Property Values (* Indicates Default)	Description
Both	Maximum	*0.0	Maximum value to which the parameter or signal is expected to be bound. (Enter information using a dialog box.)
	Code generation options		
	Storage class		Note that an auto selection for a storage class tells the build process to decide how to declare and store the selected parameter or signal.
Both	Default (Custom)		Code generation decides how to declare the data object.
Both	Global (Custom)	Global (Custom) is the default storage class for mpt data objects.	Specifies that a code generator not place a qualifier in the data object's declaration.
Both	Memory section	*Default	Memory section allows you to specify storage directives for the data object. Default specifies that the code generator not place a type qualifier and pragma statement with the data object's declaration.
Parameter		MemConst	Places the const type qualifier in the declaration.
Both		MemVolatile	Places the volatile type qualifier in the declaration.
Parameter		MemConstVolatile	Places the const volatile type qualifier in the declaration.

Parameter and Signal Property Values (Continued)

Class: Parameter, Signal, or Both	Property	Available Property Values (* Indicates Default)	Description
Both	Header file		<p>Name of the file used to import or export the data object. This file contains the declaration (<code>extern</code>) to the data object.</p> <p>Also, you can specify this header filename between the double-quotation or angle-bracket delimiter. You can specify the delimiter with or without the <code>.h</code> extension. For example, specify <code>"object.h"</code> or <code>"object"</code>. For the selected data object, this overrides the general delimiter selection in the #include file delimiter field on the Configuration Parameters dialog box.</p>
Both	Owner	*Blank	<p>The name of the module that owns this signal or parameter. This is used to help determine the ownership of a definition. For details, see “Ownership Settings” on page 15-81 and the table “Ownership Settings” on page 15-91.</p>
Both	Definition file	*Blank	<p>Name of the file that defines the data object.</p>
		Valid string	

Parameter and Signal Property Values (Continued)

Class: Parameter, Signal, or Both	Property	Available Property Values (* Indicates Default)	Description
Both	Persistence level		The number you specify is relative to Signal display level or Parameter tune level on the Code Placement pane of the Configuration Parameters dialog box. For a signal, allows you to specify whether or not the code generator declares the data object as global data. For a parameter, allows you to specify whether or not the code generator declares the data object as tunable global data. See Signal display level and Parameter tune level in “Code Generation Pane: Code Placement”.
Both	Bitfield (Custom)		Embeds Boolean data in a named bit field.
	Struct name		Name of the struct into which the object’s data will be packed.
Parameter	Const (Custom)		Places the const type qualifier in the declaration.
Parameter	Header file		See above.
Parameter	Owner		See above.
Parameter	Definition file		See above.
Parameter	Persistence level		See above.
Both	Volatile (Custom)		Places the volatile type qualifier in the declaration.
Both	Header file		See above.

Parameter and Signal Property Values (Continued)

Class: Parameter, Signal, or Both	Property	Available Property Values (* Indicates Default)	Description
Both	Owner		See above.
Both	Definition file		See above.
Both	Persistence level		See above.
Parameter	ConstVolatile (Custom)		Places the <code>const volatile</code> type qualifier in declaration.
Parameter	Header file		See above.
Parameter	Owner		See above.
Parameter	Definition file		See above.
Parameter	Persistence level		See above.
Parameter	Define (Custom)		Represents parameters with a <code>#define</code> macro.
Parameter	Header file		See above.
Both	ExportToFile (Custom)		Generates global variable definition, and generates a user-specified header (.h) file that contains the declaration (<code>extern</code>) to that variable.
Both	Memory section		See above.
Both	Header file		See above.
Both	Definition file		See above.

Parameter and Signal Property Values (Continued)

Class: Parameter, Signal, or Both	Property	Available Property Values (* Indicates Default)	Description
Both	ImportFromFile (Custom)		Includes predefined header files containing global variable declarations, and places the #include in a corresponding file. Assumes external code defines (allocates memory) for the global variable.
Both	Data access	*Direct	Allows you to specify whether the identifier that corresponds to the selected data object stores data of a data type (Direct) or stores the address of the data (a pointer).
Both		Pointer	If you select Pointer, the code generator places * before the identifier in the generated code.
	Header file		See above.
Both	Struct (Custom)		Embeds data in a named struct to encapsulate sets of data.
Both	Struct name		See above.
Signal	GetSet (Custom)		Reads (gets) and writes (sets) data using functions.
Signal	Header file		See above.
Signal	Get function		Specify the Get function.
Signal	Set function		Specify the Set function.

Parameter and Signal Property Values (Continued)

Class: Parameter, Signal, or Both	Property	Available Property Values (* Indicates Default)	Description
Both	Alias	*null	As explained in detail in “Apply Naming Rules to Identifiers Globally” on page 8-79, for a Simulink or mpt data object (identifier), specifying a name in the Alias field overrides the global naming rule selection you make on the Configuration Parameters dialog box.
		Valid ANSI ⁵ C/C++ variable name	
Both	Description	*null	Text description of the parameter or signal. Appears as a comment beside the signal or parameter’s identifier in the generated code.
		String	

5. ANSI[®] is a registered trademark of the American National Standards Institute, Inc.

Examples of Property Value Changes on Generated Code

What I noticed when inspecting the .c/.cpp file	Change I made to property value settings	What I noticed after regenerating and reinspecting the file
<p>Example 1: Parameter data objects can be declared or defined as constants. I know that the data object GAIN is a parameter. I want this to be declared or defined in the .c file as a variable. But I notice that GAIN is declared as a constant by the statement <code>const real_T GAIN = 5.0;</code>. Also, this statement is in the constant section of the file.</p>	<p>In the Model Explorer, I clicked the data object GAIN. I noticed that the property value for its Memory section property is set at MemConst. I changed this to Default.</p>	<p>I notice two differences. One is that now GAIN is declared as a variable with the statement <code>real_T GAIN = 5.0;</code>. The second difference is that the declaration now is located in the MemConst memory section in the .c or .cpp file.</p>
<p>Example 2: I notice again the declaration of GAIN in the .c file mentioned in Example 1. It appears as <code>real_T GAIN = 5.0;</code>. But I have changed my mind. I want data object GAIN to be <code>#define</code>.</p>	<p>I changed the Storage class selection to Define (Custom).</p>	<p>GAIN is not declared in the .c file as a MemConst parameter. Rather, it is defined as a <code>#define</code> macro by the code <code>#define GAIN 5.0</code>, and this is located near the top of the .c file with the other preprocessor directives.</p>

Examples of Property Value Changes on Generated Code (Continued)

What I noticed when inspecting the .c/.cpp file	Change I made to property value settings	What I noticed after regenerating and reinspecting the file
<p>Example 3: I changed my mind again after doing Example 2. I do want GAIN defined using the <code>#define</code> preprocessor directive. But I do not want to include the <code>#define</code> in this file. I know it exists in another file and I want to reference that file.</p>	<p>On the Model Explorer, I notice that the property value for the Header file property is blank. I changed this to <code>filename.h</code>. (I chose the ANSI C/C++ double quote mechanism for the <code>#include</code>, but could have chosen the angle bracket mechanism.) Also, I must make the user-defined <code>filename.h</code> available to the compiler, placing it either in the system path or local directory.</p>	<p><code>#define GAIN 5.0</code> is not present in this <code>.c</code> file. Instead, the <code>#include filename.h</code> code appears as a preprocessor directive at the top of the file.</p>
<p>Example 4: I have one more change I want to make. Let us say that we have declared the data object <code>data_in</code>, and that its declaration statement in the <code>.c</code> file reads <code>real_T data_in = 0.0;</code>. I want to replace this statement with an alias in the <code>.c</code> file.</p>	<p>In the Model Explorer, I selected the data object <code>data_in</code>. I noticed that the Alias field is blank. I changed this to <code>data_in_alias</code>, which I know is a valid ANSI C/C++ variable name.</p>	<p>The identifier <code>data_in_alias</code> now appears in the <code>.c</code> file everywhere <code>data_in</code> appeared.</p>

Custom Storage Classes

- “Introduction to Custom Storage Classes” on page 10-2
- “Resources for Defining Custom Storage Classes” on page 10-5
- “Simulink Package Custom Storage Classes” on page 10-6
- “Design Custom Storage Classes and Memory Sections” on page 10-8
- “Apply Custom Storage Classes” on page 10-34
- “Generate Code with Custom Storage Classes” on page 10-53
- “Define Advanced Custom Storage Classes Types” on page 10-57
- “GetSet Custom Storage Classes” on page 10-61
- “Custom Storage Class Implementation” on page 10-65
- “Custom Storage Class Limitations” on page 10-67

Introduction to Custom Storage Classes

In this section...
“Custom Storage Class Memory Sections” on page 10-3
“Register Custom Storage Classes” on page 10-3
“Custom Storage Class Examples” on page 10-4

During the build process, the *storage class* specification of a signal, tunable parameter, block state, or data object specifies how that entity is declared, stored, and represented in generated code. Note that in the context of the build process, the term “storage class” is not synonymous with the term “storage class specifier”, as used in the C language.

The Simulink Coder software defines four built-in storage classes for use with targets: `Auto`, `ExportedGlobal`, `ImportedExtern`, and `ImportedExternPointer`. These storage classes provide limited control over the form of the code generated for references to the data. For example, data of storage class `Auto` is typically declared and accessed as an element of a structure, while data of storage class `ExportedGlobal` is declared and accessed as unstructured global variables. For information about built-in storage classes, see “Signals” in the Simulink Coder documentation.

If the built-in storage classes do not provide data representation required by your application, you can define *custom storage classes* (CSCs). Embedded Coder (CSCs) extend the built-in storage classes provided by the Simulink Coder software. CSCs can provide application-specific control over the constructs required to represent data in an embedded algorithm. For example, you can use CSCs to:

- Define structures for storage of parameter or signal data.
- Conserve memory by storing Boolean data in bit fields.
- Integrate generated code with legacy software whose interfaces cannot be modified.
- Generate data structures and definitions that comply with your organization’s software engineering guidelines for safety-critical code.

Custom storage classes affect only code generated for ERT targets. When **Configuration Parameters > Code Generation > Target Selection > System target file** specifies a GRT target, the names of custom storage classes sometimes appear in dialog boxes, but selecting a CSC is functionally the same as selecting Auto. See “Targets and Code Formats” for information about ERT and GRT targets.

Custom Storage Class Memory Sections

Every custom storage class has an associated *memory section* definition. A memory section is a named collection of properties related to placement of an object in memory; for example, in RAM, ROM, or flash memory. Memory section properties let you specify storage directives for data objects. For example, you can specify `const` declarations, or compiler-specific `#pragma` statements for allocation of storage in ROM or flash memory sections.

See “Create and Edit Memory Section Definitions” on page 10-28 for details about using the Custom Storage Class designer to define memory sections. While memory sections are often used with data in custom storage classes, they can also be used with various other constructs. See “Memory Sections” for more information about using memory sections with custom storage classes, and complete information about using memory sections with other constructs.

Register Custom Storage Classes

CSCs are associated with Simulink data class packages (such as the `Simulink` package) and with classes within packages (such as the `Simulink.Parameter` and `Simulink.Signal` classes). The custom storage classes associated with a package are defined by a *CSC registration file*. For example, a CSC registration file exists for the `Simulink` package. This registration file provides predefined CSCs for use with the `Simulink.Signal` and `Simulink.Parameter` classes, and with subclasses derived from these classes. The predefined CSCs are used for a wide variety of applications.

If you use only predefined CSCs, you do not need to be concerned with CSC registration files. You cannot add or change CSCs associated with built-in packages and classes, but you can create your own packages and subclasses, then associate CSCs with those. See “Custom Storage Class Implementation” on page 10-65 for more information.

Custom Storage Class Examples

Three examples show Custom Storage Class capabilities:

`rtwdemo_cscpredef` — Shows predefined custom storage classes and embedded signal objects

`rtwdemo_importstruct` — Shows custom storage classes used to access imported data efficiently

`rtwdemo_advsc` — Shows how custom storage classes can support data dictionary driven modeling

Click the links above, or type the name in the MATLAB Command Window.

Resources for Defining Custom Storage Classes

The resources for working with custom storage class definitions are:

- Use MATLAB class syntax to create a data class in a package. You can assign properties to the data class and add initialization code to enable custom storage class definition. For complete instructions, see “Define Data Classes” in Simulink documentation.
- A set of ready-to-use CSCs. These CSCs are designed to be useful in code generation for embedded systems development. CSC functionality is integrated into the `Simulink.Signal` and `Simulink.Parameter` classes; you do not need to use special object classes to generate code with CSCs.
- The Custom Storage Class Designer (`cscdesigner`) tool, which is described in this chapter. This tool lets you define CSCs that are tailored to your code generation requirements. The Custom Storage Class Designer provides a graphical user interface that you can use to implement CSCs. You can use your CSCs in code generation immediately, without a Target Language Compiler (TLC) or other programming. See “Design Custom Storage Classes and Memory Sections” on page 10-8 for details.

Simulink Package Custom Storage Classes

The Simulink package includes a set of built-in custom storage classes. These are categorized as custom storage classes, even though they are built-in, because they:

- Extend the storage classes provided by the Simulink Coder software
- Are functionally the same as if you had defined them yourself using the CSC Designer

You cannot change the CSCs built into the Simulink package, but you can subclass the package and add CSCs to the subclass, following the steps in “Resources for Defining Custom Storage Classes” on page 10-5.

Some CSCs in the Simulink package are valid for parameter objects but not signal objects and vice versa. For example, you can assign the storage class `Const` to a parameter but not to a signal, because signal data is not constant. The next table defines the CSCs built into the Simulink package and shows where each of the CSCs can be used.

CSC Name	Purpose	Signals?	Parameters?
BitField	Generate a struct declaration that embeds Boolean data in named bit fields.	Y	Y
CompilerFlag	Supports preprocessor conditionals defined via compiler flag. See “Generate Preprocessor Conditionals for Variant Systems” on page 6-4.	N	Y
Const	Generate a constant declaration with the <code>const</code> type qualifier.	N	Y
ConstVolatile	Generate declaration of volatile constant with the <code>const volatile</code> type qualifier.	N	Y

CSC Name	Purpose	Signals?	Parameters?
Default	Default is a placeholder CSC that the code generator assigns to the <code>CoderInfo.CustomStorageClass</code> property of signal and parameter objects when they are created. You cannot edit the Default CSC definition.	Y	Y
Define	Generate <code>#define</code> directive.	N	Y
ExportToFile	Generate header (.h) file, with user-specified name, containing global variable declarations.	Y	Y
FileScope	Generate a static qualifier suffix for a variable declaration so that the scope of the variable is limited to the current file.	Y	Y
GetSet	Supports specialized function calls to read and write the memory associated with a Data Store Memory block. See “GetSet Custom Storage Classes” on page 10-61.	Y	Y
ImportedDefine	Supports preprocessor conditionals defined via legacy header file. See “Generate Preprocessor Conditionals for Variant Systems” on page 6-4.	N	Y
ImportFromFile	Generate directives to include predefined header files containing global variable declarations.	Y	Y
Struct	Generate a struct declaration encapsulating parameter or signal object data.	Y	Y
Volatile	Use volatile type qualifier in declaration.	Y	Y

Design Custom Storage Classes and Memory Sections

In this section...

“Create Packages for Custom Storage Class Definitions” on page 10-8

“Use Custom Storage Class Designer” on page 10-8

“Edit Custom Storage Class Properties” on page 10-16

“Use Custom Storage Class References” on page 10-23

“Create and Edit Memory Section Definitions” on page 10-28

“Use Memory Section References” on page 10-31

Create Packages for Custom Storage Class Definitions

Use MATLAB class syntax to create a data class in a package. You can assign properties to the data class and add initialization code to enable custom storage class definition. For complete instructions, see “Define Data Classes” in the Simulink documentation.

Use Custom Storage Class Designer

The Custom Storage Class Designer (`cscdesigner`) is a tool for creating and managing custom storage classes and memory sections. You can use the Custom Storage Class Designer to:

- Load existing custom storage classes and memory sections and view and edit their properties
- Create new custom storage classes and memory sections
- Create references to custom storage classes and memory sections defined in other packages
- Copy and modify existing custom storage class and memory section definitions
- Check a custom storage class and memory section definitions
- Preview pseudocode generated from custom storage class and memory section definitions

- Save custom storage class and memory section definitions

To open the Custom Storage Class Designer for a particular package, type the following command at the MATLAB prompt:

```
cscdesigner ('mypkg')
```

When first opened, the Custom Storage Class Designer scans data class packages on the MATLAB path to detect packages that have a CSC registration file. A message is displayed while scanning proceeds. When the scan is complete, the Custom Storage Class Designer window appears:

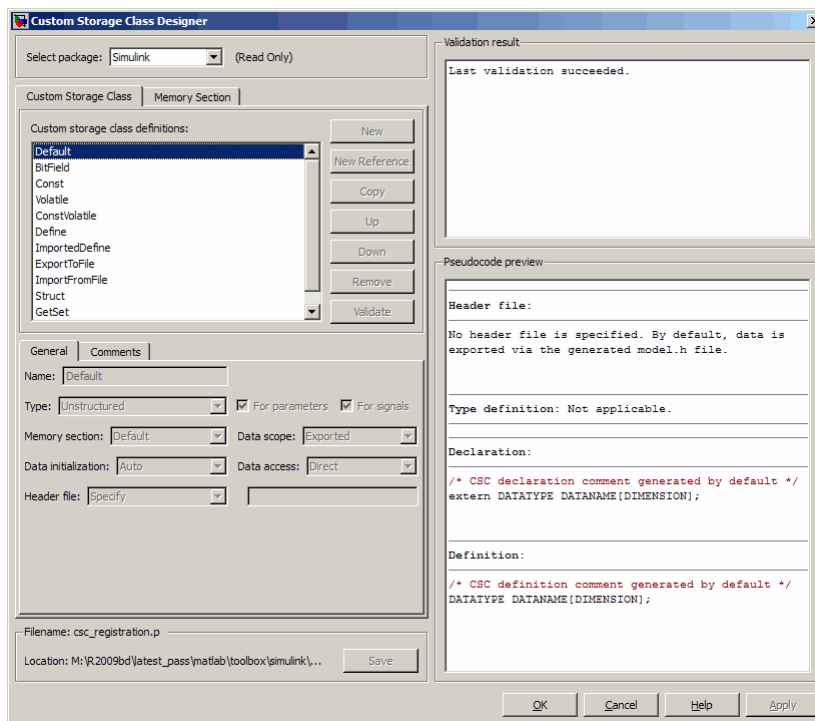

The Custom Storage Class Designer window is divided into several panels:

- **Select package:** Lets you select from a menu of data class packages that have CSC definitions associated with them. See “Select Data Class Package” on page 10-10 for details.

- **Custom Storage Class / Memory Section** properties: Lets you select, view, edit, copy, verify, and perform other operations on CSC definitions or memory section definitions. The common controls in the **Custom Storage Class / Memory Section** properties panel are described in “Manipulate Custom Storage Classes and Memory Sections” on page 10-11.
 - When the **Custom Storage Class** tab is selected, you can select a CSC definition or reference from a list and edit its properties. See “Edit Custom Storage Class Properties” on page 10-16 for details.
 - When the **Memory Section** tab is selected, you can select a memory section definition or reference from a list and edit its properties. See “Create and Edit Memory Section Definitions” on page 10-28 for details.
- **Filename:** Displays the filename and location of the current CSC registration file, and lets you save your CSC definition to that file. See “Save Definitions” on page 10-15 for details.
- **Pseudocode preview:** Displays a preview of code that is generated from objects of the given class. The preview is pseudocode, since the actual symbolic representation of data objects is not available until code generation time. See “Preview Generated Code” on page 10-30 for details.
- **Validation result:** Displays errors encountered when the currently selected CSC definition is validated. See “Validate Definitions Category” on page 10-23 for details.

Select Data Class Package

A CSC or memory section definition or reference is uniquely associated with a Simulink data class package. The link between the definition/reference and the package is formed when a CSC registration file (`csc_registration.m`) is located in the package directory.

You need not search for or edit a CSC registration file directly: the Custom Storage Class Designer locates available CSC registration files. The **Select package** menu contains names of data class packages that have a CSC registration file on the MATLAB search path.

When you select a package, the CSCs and memory section definitions belonging to the package are loaded into memory and their names are displayed in the scrolling list in the **Custom storage class** panel. The name

and location of the CSC registration file for the package is displayed in the **Filename** panel.

If you select a user-defined package, by default you can use the Custom Storage Class Designer to edit its custom storage classes and memory sections. If you select a built-in package, you cannot edit its custom storage classes or memory sections. See “Custom Storage Class Implementation” on page 10-65 for more information.

Manipulate Custom Storage Classes and Memory Sections

The **Custom Storage Class / Memory Section** panel lets you select, view, and (if the CSC is writable) edit CSC and memory section definitions and references. In the next figure and the subsequent examples, the selected package is `mypkg`. Instructions for creating a user-defined package like `mypkg` appear in “Design Custom Storage Classes and Memory Sections” on page 10-8.

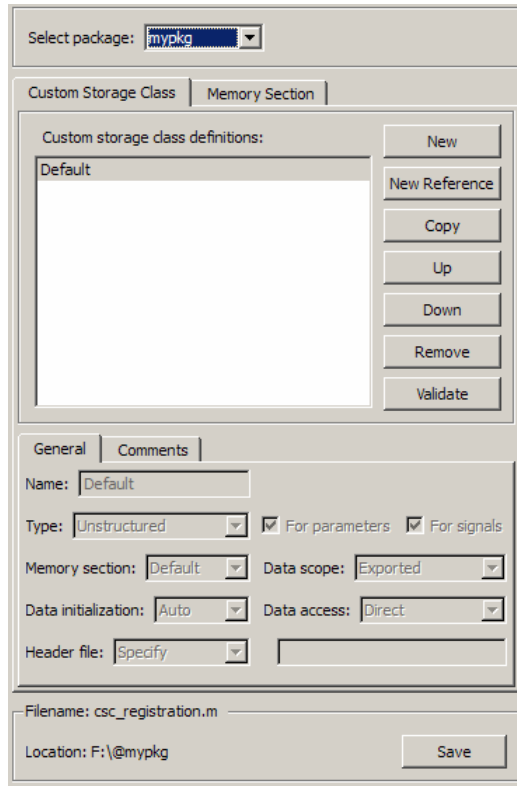

The list at the top of the panel displays the definitions/references for the currently selected package. To select a definition/reference for viewing and editing, click on the desired list entry. The properties of the selected definition/reference appear in the area below the list. The number and type of properties vary for different types of CSC and memory section definitions. See:

- “Edit Custom Storage Class Properties” on page 10-16 for information about the properties of the predefined CSCs.
- “Create and Edit Memory Section Definitions” on page 10-28 for information about the properties of the predefined memory section definitions.

The buttons to the right of the list perform these functions, which are common to both custom storage classes and memory definitions:

- **New:** Creates a new CSC or memory section with default values.
- **New Reference:** Creates a reference to a CSC or memory section definition in another package. The default initially has a default name and properties. See “Use Custom Storage Class References” on page 10-23 and “Use Memory Section References” on page 10-31.
- **Copy:** Creates a copy of the selected definition / reference. The copy initially has a default name using the convention:

`definition_name_n`

where `definition_name` is the name of the original definition, and `n` is an integer indicating successive copy numbers (for example: `BitField_1`, `BitField_2`, ...)

- **Up:** Moves the selected definition one position up in the list.
- **Down:** Moves the selected definition one position down in the list
- **Remove:** Removes the selected definition from the list.
- **Validate:** Performs a consistency check on the currently selected definition. Errors are reported in the **Validation result** panel.

For example, if you click **New**, a new custom storage class is created with a default name:

Select package: mypkg

Custom Storage Class | Memory Section

Custom storage class definitions:

Default	New
NewCSC_1	New Reference

Copy
Up
Down
Remove
Validate

General | Comments

Name: NewCSC_1

Type: Unstructured For parameters For signals

Memory section: Default Data scope: Auto

Data initialization: Auto Data access: Direct

Header file: Specify

You can now rename the new class by typing the desired name into the **Name** field, and specify other fields.

Note The class name must be a valid MATLAB variable name. See “Variable Names”

Click **Apply** or **OK**. For example, you could set values for the new custom storage class as follows:

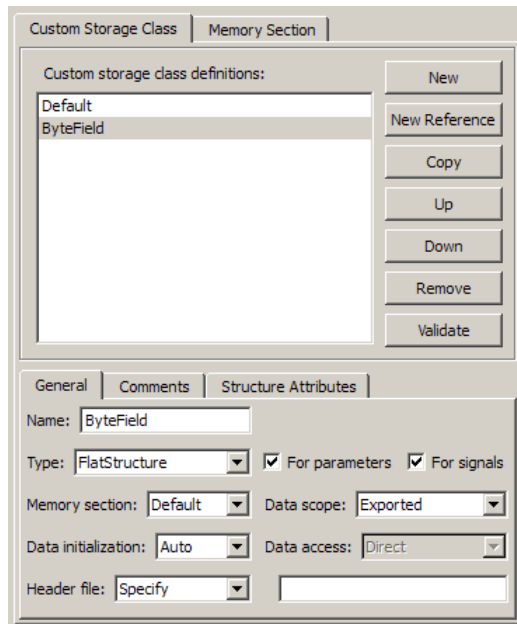

Save Definitions

After you have created or edited a CSC or memory section definition or reference, you must save the changes to the CSC registration file. To do this, click **Save** in the **Filename** panel. When you click **Save**, the current CSC and memory section definitions that are in memory are validated, and the definitions are written out.

If errors occur, they are reported in the **Validation result** panel. The definitions are saved whether or not errors exist. However, you should resolve validation errors and resave your definitions. Trying to use definitions that were saved with validation errors can cause additional errors. Such problems can occur even if you do not try to use the specific parts of the definition that contain the validation errors, making the problems difficult to diagnose.

Restart MATLAB After Changing Definitions

If you add, change, or delete custom storage class or memory section definitions for a user-defined class, and objects of that class already exist, you must restart MATLAB to use the changed definitions and to eliminate

obsolete objects. When you save the changed definitions, a message appears indicating that you must restart MATLAB.

Edit Custom Storage Class Properties

To view and edit the properties of a CSC, click the **Custom Storage Class** tab in the **Custom Storage Class / Memory Section** panel. Then, select a CSC name from the **Custom storage class definitions** list.

The CSC properties are divided into several categories, selected by tabs. Selecting a class, and setting property values for that class, can change the available tabs, properties, and values. As you change property values, the changes in the generated code is immediately displayed in the **Pseudocode preview** panel. In most cases, you can define your CSCs quickly and easily by selecting the **Pseudocode preview** panel and using the **Validate** button frequently.

The property categories and corresponding tabs are as follows:

General Category

Properties in the **General** category are common to CSCs. In the next figure and the subsequent examples, the selected custom storage class is `ByteField`. Instructions for creating a user-defined custom storage class like `ByteField` appear in “Manipulate Custom Storage Classes and Memory Sections” on page 10-11.

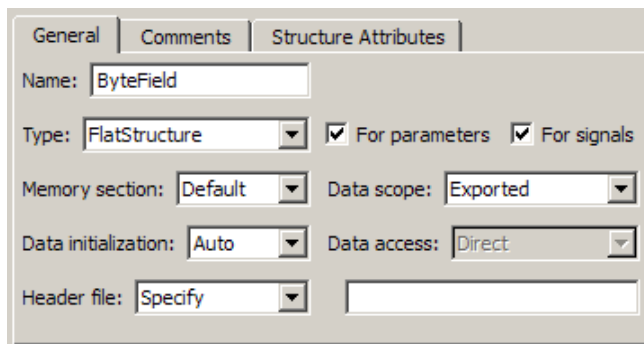

The screenshot shows the 'General' tab of the Custom Storage Class Properties dialog box. The 'Name' field is set to 'ByteField'. The 'Type' is 'FlatStructure'. The 'For parameters' and 'For signals' checkboxes are checked. The 'Memory section' is 'Default', 'Data scope' is 'Exported', 'Data initialization' is 'Auto', and 'Data access' is 'Direct'. The 'Header file' is set to 'Specify'.

Property	Value
Name	ByteField
Type	FlatStructure
For parameters	<input checked="" type="checkbox"/>
For signals	<input checked="" type="checkbox"/>
Memory section	Default
Data scope	Exported
Data initialization	Auto
Data access	Direct
Header file	Specify

Properties in the **General** category, and the possible values for each property, are as follows:

- **Name:** The CSC name, selected from the **Custom storage class definitions** list. The name cannot be a TLC keyword. Violating this rule causes an error.
- **Type:** Specifies how objects of this class are stored. Values:
 - **Unstructured:** Objects of this class generate unstructured storage declarations (for example, scalar or array variables), for example:

```
datatype dataname[dimension];
```
 - **FlatStructure:** Objects of this class are stored as members of a struct. A **Structure Attributes** tab is also displayed, allowing you to specify additional properties such as the struct name. See “Structure Attributes Category” on page 10-21.
 - **Other:** Used for certain data layouts, such as nested structures, that cannot be generated using the standard **Unstructured** and **FlatStructure** custom storage class types. If you want to generate other types of data, you can create a new custom storage class from scratch by writing TLC code. See “Define Advanced Custom Storage Classes Types” on page 10-57 for more information.
- **For parameters** and **For signals:** These options let you enable a CSC for use with only certain classes of data objects. For example, it does not make sense to assign storage class **Const** to a **Simulink.Signal** object. Accordingly, the **For signals** option for the **Const** class is deselected, while the **For parameters** is selected.
- **Memory section:** Selects one of the memory sections defined in the **Memory Section** panel. See “Create and Edit Memory Section Definitions” on page 10-28.
- **Data scope:** Controls the scope of symbols generated for data objects of this class. Values:
 - **Auto:** Symbol scope is determined internally by code generation. If possible, symbols have **File** scope. Otherwise, they have **Exported** scope.

- **Exported:** Symbols are exported to external code in the header file specified by the **Header File** field. If a **Header File** is not specified, symbols are exported to external code in *model.h*.
- **Imported:** Symbols are imported from external code in the header file specified by the **Header File** field. If you do not specify a header file, an `extern` directive is generated in *model_private.h*. For imported data, if the **Data initialization** value is `Macro`, a header file *must* be specified.
- **File:** The scope of each symbol is the file that defines it. File scope requires each symbol to be used in a single file. If the same symbol is referenced in multiple files, an error occurs at code generation time.
- **Instance specific:** Symbol scope is defined by the **Data scope** field of the `CoderInfo.CustomAttributes` property of each data object.
- **Data initialization:** Controls how storage is initialized in generated code. Values:
 - **Auto:** Storage initialization is determined internally by the code generation. Parameters have `Static` initialization, and signals have `Dynamic` initialization.
 - **None:** Initialization code is not generated.
 - **Static:** A static initializer of the following form is generated:

```
datatype dataname[dimension] = {...};
```
 - **Dynamic:** Variable storage is initialized at runtime, in the *model_initialize* function.
 - **Macro:** A macro definition of the following form is generated:

```
#define data numeric_value
```

The `Macro` initialization option is available only for use with unstructured parameters. It is not available when the class is configured for generation of structured data, or for signals. If the **Data scope** value is `Imported`, a header file *must* be specified.
- **Instance specific:** Initialization is defined by the **Data initialization** property of each data object.

Note The code generator might include dynamic initialization code for signals and states even if the CSC has **Data initialization** set to None or Static, if the initialization is required.

- **Data access:** Controls whether imported symbols are declared as variables or pointers. This field is enabled only when **Data scope** is set to Imported or Instance-specific. Values:
 - Direct: Symbols are declared as simple variables, such as

```
extern myType myVariable;
```
 - Pointer: Symbols are declared as pointer variables, such as

```
extern myType *myVariable;
```
 - Instance specific: Data access is defined by the **Data access** property of each data object.
- **Header file:** Defines the name of a header file that contains exported or imported variable declarations for objects of this class. Values:
 - Specify: An edit field is displayed to the right of the property. This lets you specify a header file for exported or imported storage declarations. Specify the full filename, including the filename extension (such as `.h`). Use quotes or brackets as in C code to specify the location of the header file. Leave the edit field empty to not specify a header file.
 - Instance specific: The header file for each data object is defined by the **Header file** property of the object. Leave the property undefined to not specify a header file for that object.

If the **Data scope** is Exported, specifying a header file is optional. If you specify a header file name, the custom storage class generates a header file containing the storage declarations to be exported. Otherwise, the storage declarations are exported in `model.h`.

If the **Data scope** of the class is Imported, and **Data initialization** is Macro, you *must* specify a header file name. A `#include` directive for the header file is generated.

Comments Category

Comments. The **Comments** panel lets you specify comments to be generated with definitions and declarations.

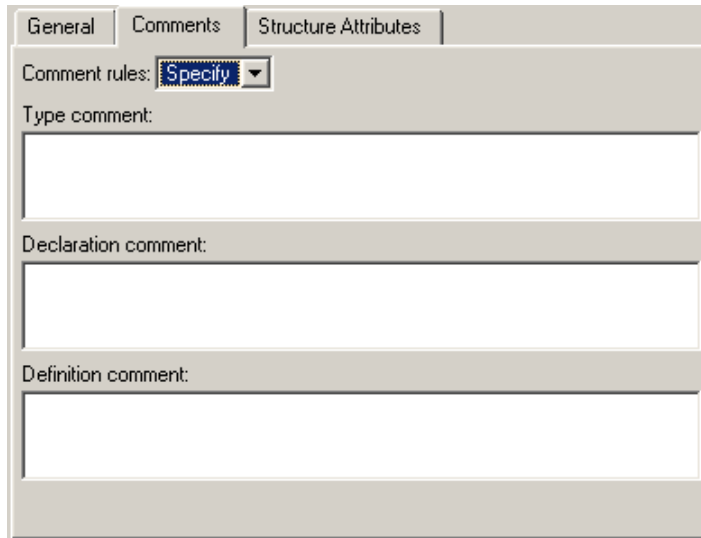

The screenshot shows a dialog box with three tabs: "General", "Comments", and "Structure Attributes". The "Comments" tab is active. It contains a "Comment rules:" dropdown menu with "Specify" selected. Below this are three text input fields labeled "Type comment:", "Declaration comment:", and "Definition comment:".

Comments must conform to the ANSI C standard (`/*...*/`). Use `\n` to specify a new line.

Properties in the **Comments** tab are as follows:

- **Comment rules:** If **Specify** is selected, edit fields are displayed for entering comments. If **Default** is selected, comments are generated under control of the code generation software.
- **Type comment:** The comment entered in this field precedes the `typedef` or `struct` definition for structured data.
- **Declaration comment:** Comment that precedes the storage declaration.
- **Definition comment:** Comment that precedes the storage definition.

Structure Attributes Category

The **Structure Attributes** panel gives you detailed control over code generation for structs (including bitfields). The **Structure Attributes** tab is displayed for CSCs whose **Type** parameter is set to `FlatStructure`. The following figure shows the **Structure Attributes** panel.

Structure Attributes Panel

The **Structure Attributes** properties are as follows:

- **Struct name:** If you select `Instance specific`, specify the struct name when configuring each instance of the class.

If you select `Specify`, an edit field appears for entry of the name of the structure to be used in the struct definition. Edit fields **Type tag**, **Type token**, and **Type name** are also displayed.

- **Is typedef:** When this option is selected a typedef is generated for the struct definition, for example:

```
typedef struct {
    ...
} SignalDataStruct;
```

Otherwise, a simple struct definition is generated.

- **Bit-pack booleans:** When this option is selected, signals and/or parameters that have Boolean data type are packed into bit fields in the generated struct.
- **Type tag:** Specifies a tag to be generated after the `struct` keyword in the struct definition.

- **Type token:** Some compilers support an additional token (which is simply another string) after the type tag. To generate such a token, enter the string in this field.
- **Type name:** Specifies the string to be used in typedef definitions. This field is visible if **Is typedef** is selected.

The following listing is the pseudocode preview corresponding to the **Structure Attributes** properties displayed in.

Header file:

No header file is specified. By default, data is exported with the generated model.h file.

Type definition:

```
/* CSC type comment generated by default */  
  
typedef struct aToken myTag {  
    :  
} myType;
```

Declaration:

```
/* CSC declaration comment generated by default */  
  
extern myType MyStruct;
```

Definition:

```
/* CSC definition comment generated by default */  
  
myType MyStruct = {...};
```

Validate Definitions Category

To validate a CSC definition, select the definition on the **Custom Storage Class** panel and click **Validate**. The Custom Storage Class Designer then checks the definition for consistency. The **Validation result** panel displays a errors encountered when the selected CSC definition is validated. The next figure shows the **Validation result** panel with a typical error message:

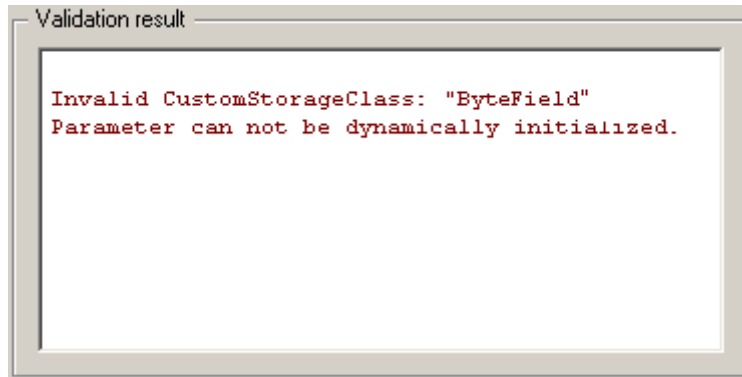

Validation is also performed whenever CSC definitions are saved. In this case, all CSC definitions are validated. (See “Save Definitions” on page 10-15.)

Use Custom Storage Class References

Packages can access and use custom storage classes that are defined in other packages, including both user-defined packages and predefined packages such as Simulink and mpt. Only one copy of the storage class exists, in the package that first defined it. Other packages refer to it by pointing to it in its original location. Changes to the class, including changes to a predefined class in later MathWorks product releases, are immediately available in every referencing package.

To configure a package to use a custom storage class that is defined in another package:

- 1 Type `cscdesigner` to launch the Custom Storage Class Designer. The relevant part of the designer window initially looks like this:

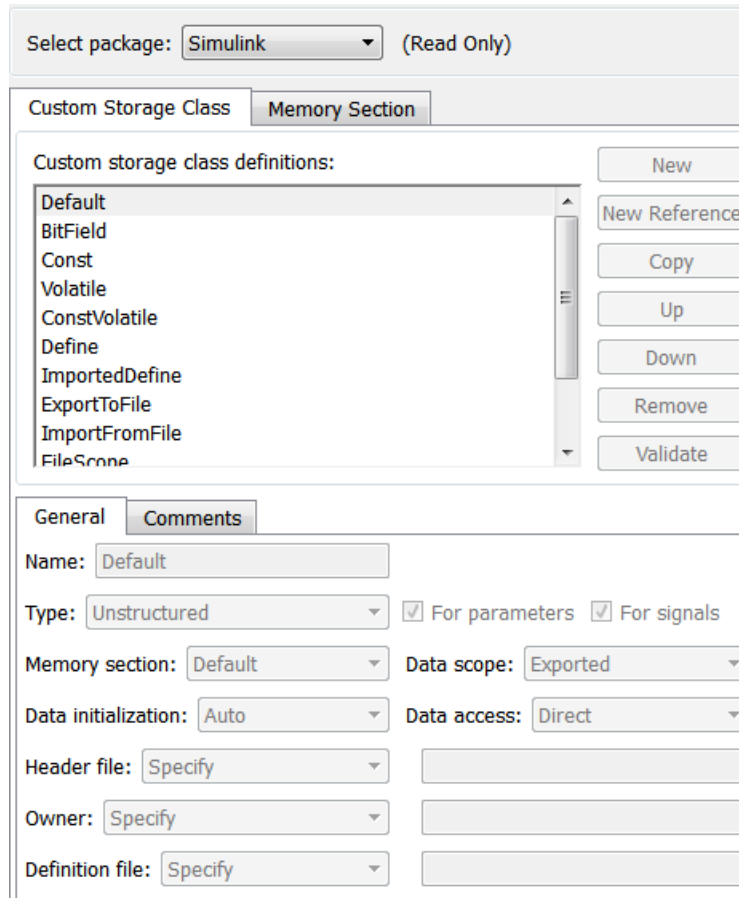

- 2 Select the **Custom Storage Class** tab.
- 3 Use **Select Package** to select the package in which you want to reference a class or section defined in some other package. The selected package must be writable.
- 4 In the **Custom storage class definitions** pane, select the existing definition below which you want to insert the reference. For example:

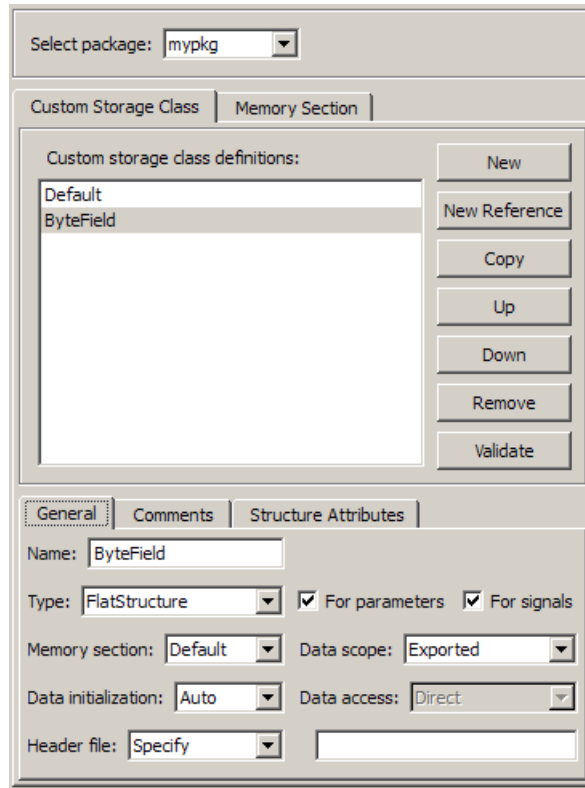

5 Click New Reference.

A new reference with a default name and properties appears below the previously selected definition. The new reference is selected, and a **Reference** tab appears that shows the reference's initial properties. A typical appearance is:

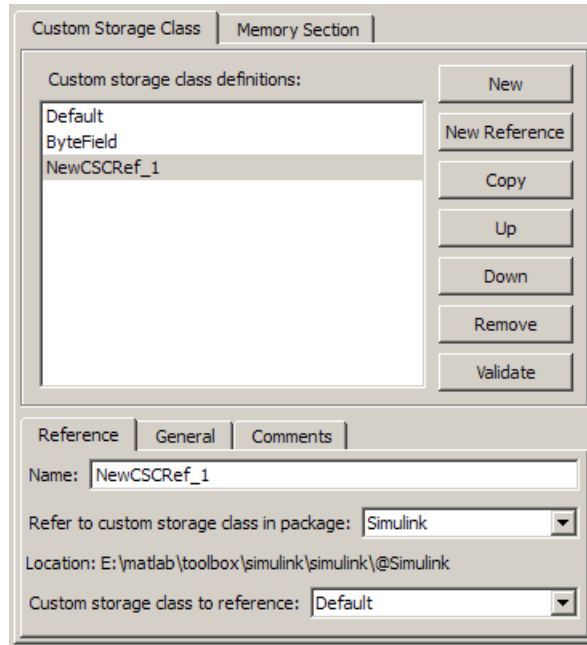

- 6** Use the **Name** field to enter a name for the new reference. The name must be unique in the importing package, but can duplicate the name in the source package. The name cannot be a TLC keyword. Violating this rule causes an error.
- 7** Set **Refer to custom storage class in package** to specify the package that contains the custom storage class you want to reference.
- 8** Set **Custom storage class to reference** to specify the custom storage class to be referenced. Trying to create a circular reference generates an error and leaves the package unchanged.
- 9** Click **OK** or **Apply** to save the changes to memory. See “Save Definitions” on page 10-15 for information about saving changes permanently.

For example, the next figure shows the custom storage class `ConstVolatile` imported from the `Simulink` package into `mypkg`, and given the same name that it has in the source package. Other names could have been used without affecting the properties of the storage class.

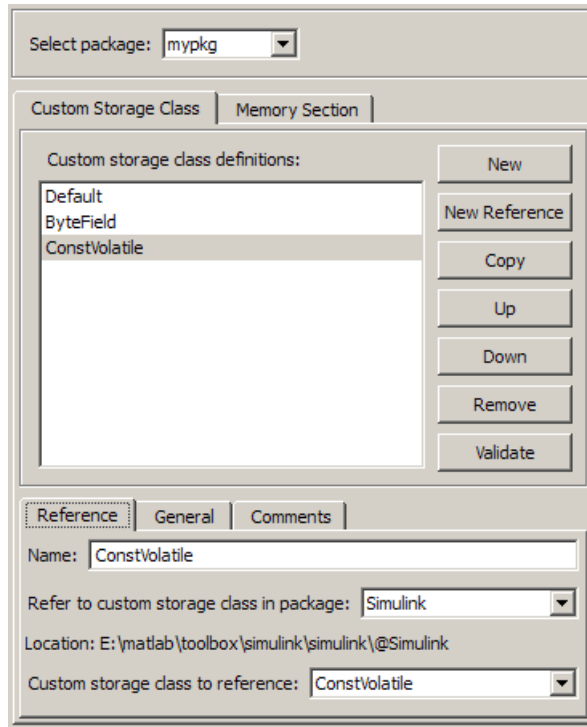

You can use Custom Storage Class Designer capabilities to copy, reorder, validate, and otherwise manage classes that have been added to a class by reference. However, you cannot change the underlying definitions. You can change a custom storage class only in the package where it was originally defined.

Change Existing Custom Storage Class References

To change an existing CSC reference, select it in the **Custom storage class definitions** pane. The **Reference** tab appears, showing the current properties of the reference. Make changes, then click **OK** or **Apply** to save the changes to memory. See “Save Definitions” on page 10-15 for information about saving changes permanently.

Create and Edit Memory Section Definitions

Memory section definitions add comments, qualifiers, and #pragma directives to generated symbol declarations. The **Memory Section** tab lets you create, view, edit, and verify memory section definitions. The steps for creating a memory section definition are essentially the same as for creating a custom storage class definition:

- 1** Select a writable package in the **Select package** field.
- 2** Select the **Memory Section** tab. In a new package, only a Default memory section initially appears.
- 3** Select the existing memory section below which you want to create a new memory section.
- 4** Click **New**.

A new memory section definition with a default name appears below the selected memory section.

- 5** Set the name and other properties of the memory section.
- 6** Click **OK** or **Apply**.

The next figure shows mypkg with a memory section called MyMemSect:

The image shows a software configuration window with two main panels. The top panel, titled "Custom Storage Class", has a "Memory Section" sub-panel selected. It features a "Select package:" dropdown menu set to "mypkg". Below this is a list of "Memory section definitions" containing "Default" and "MyMemSect". To the right of the list are buttons for "New", "New Reference", "Copy", "Up", "Down", "Remove", and "Validate". The bottom panel, titled "Memory Section", is for editing the selected "MyMemSect" definition. It includes a "Name:" field with "MyMemSect", checkboxes for "Is const" and "Is volatile" (both checked), a "Qualifier:" field, a "Comment:" text area, a "Pragma surrounds:" dropdown menu set to "All variabl", and two empty text areas for "Pre-memory-section pragma:" and "Post-memory-section pragma:".

The **Memory section definitions** list lets you select a memory section definition to view or edit. The available memory section definitions also appear in the **Memory section name** menu in the **Custom Storage Class** panel. The properties of a memory section definition are as follows:

- **Memory section name:** Name of the memory section (displayed in **Memory section definitions** list).

- **Is const:** If selected, a `const` qualifier is added to the symbol declarations.
- **Is volatile:** If selected, a `volatile` qualifier is added to the symbol declarations.
- **Qualifier:** The string entered into this field is added to the symbol declarations as a further qualifier. Note that verification is not performed on this qualifier.
- **Memory section comment:** Comment inserted before declarations belonging to this memory section. Comments must conform to the ANSI C standard (`/*...*/`). Use `\n` to specify a new line.
- **Pragma surrounds:** Specifies whether the pragma should surround `All variables` or `Each variable`. When **Pragma surrounds** is set to `Each variable`, the `%<identifier>` token is allowed in pragmas and will be replaced by the variable or function name.
- **Pre-memory section pragma:** pragma directive that precedes the storage definition of data belonging to this memory section. The directive must begin with `#pragma`.
- **Post-memory section pragma:** pragma directive that follows the storage definition of data belonging to this memory section. The directive must begin with `#pragma`.

Preview Generated Code

If you click **Validate** on the **Memory Section** panel, the **Pseudocode preview** panel displays a preview of code that is generated from objects of the given class. The panel also displays messages (in blue) to highlight changes as they are made. The code preview changes dynamically as you edit the class properties. The next figure shows a code preview for the `MemConstVolatile` memory section.

```

Pseudocode preview
-----
Header file: Not applicable.
-----
Type definition: Not applicable.
-----
Declaration:
extern const volatile DATATYPE DATANAME;
-----
Definition:
/* ConstVolatile memory section */
const volatile DATATYPE DATANAME;

```

Use Memory Section References

Packages can access and use memory sections that are defined in other packages, including both user-defined packages and predefined packages such as Simulink and mpt. Only one copy of the section exists, in the package that first defined it; other packages refer to it by pointing to it in its original location. Changes to the section, including changes to a predefined section in later MathWorks product releases, are immediately available in every referencing package.

To configure a package to use a memory section that is defined in another package:

- 1** Type `cscdesigner` to launch the Custom Storage Class Designer.
- 2** Select the **Memory Section** tab.
- 3** Use **Select Package** to select the package in which you want to reference a class or section defined in some other package.
- 4** In the **Memory section definitions** pane, select the existing definition below which you want to insert the reference.
- 5** Click **New Reference**.

A new reference with a default name and properties appears below the previously selected definition. The new reference is selected, and a **Reference** tab appears that shows the reference's initial properties.

- 6** Use the **Name** field to enter a name for the new reference. The name must be unique in the importing package, but can duplicate the name in the source package.
- 7** Set **Refer to memory section in package** to specify the package that contains the memory section you want to reference.
- 8** Set **Memory section to reference** to specify the memory section to be referenced. Trying to create a circular reference generates an error and leaves the package unchanged.
- 9** Click **OK** or **Apply** to save the changes to memory. See “Save Definitions” on page 10-15 for information about saving changes permanently.

For example, the next figure shows the memory section `MemConstVolatile` imported from the `Simulink` package into `mypkg`, and given the same name that it has in the source package. Other names could have been used without affecting the properties of the memory section.

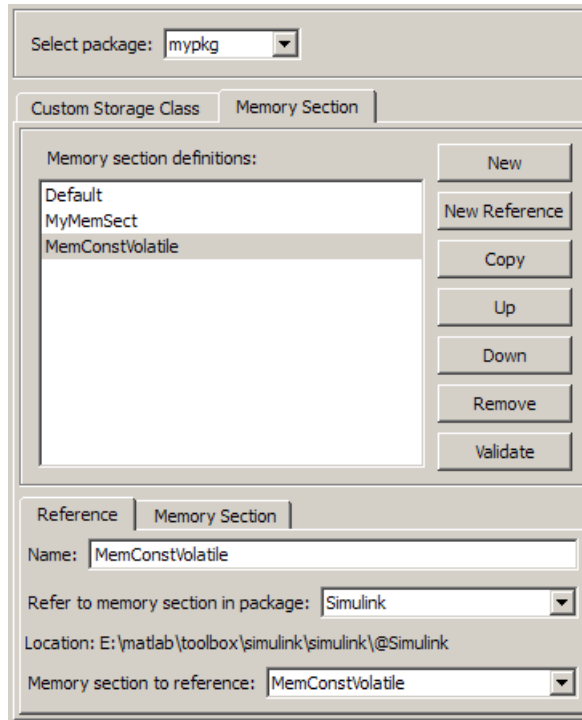

You can use Custom Storage Class Designer capabilities to copy, reorder, validate, and otherwise manage memory sections that have been added to a class by reference. However, you cannot change the underlying definitions. You can change a memory section only in the package where it was originally defined.

Change Existing Memory Section References

To change an existing memory section reference, select it in the **Memory section definitions** pane. The **Reference** tab appears, showing the current properties of the reference. Make changes, then click **OK** or **Apply** to save the changes to memory. See “Save Definitions” on page 10-15 for information about saving changes permanently.

Apply Custom Storage Classes

In this section...

“About Applying Custom Storage Classes” on page 10-34

“Apply Custom Storage Classes to Parameters” on page 10-35

“Apply Custom Storage Classes to Signals” on page 10-36

“Custom Storage Classes Using Signal Objects” on page 10-37

“Custom Storage Classes Using Embedded Signal Objects” on page 10-39

“Specify Custom Storage Classes Using GUI” on page 10-46

“Specify Custom Storages Classes Using API” on page 10-48

About Applying Custom Storage Classes

You can apply a custom storage class to a parameter or a signal using the GUI or the API.

- To apply a custom storage class to a parameter, you specify the storage class in the `Simulink.Parameter` object that defines the parameter in the base workspace.
- To apply a custom storage class to a signal, you specify the storage class in a `Simulink.Signal` object that is bound to the signal. You can provide this object in two ways:
 - Create the object in the base workspace, then bind it to the signal as described in “Symbol Resolution”. When you save the model, you must save the object in a separate file, as with base workspace objects.
 - Use the Signal Properties dialog box to embed the object in the model on the port where the signal originates. When you save the model, Simulink automatically saves the embedded signal object as part of the model file.

Most of the GUI techniques, and most of the API techniques, are the same for parameter and signal objects, and for base workspace and embedded signal objects. Only the initial steps differ, after which you apply the same GUI or API instructions within the context that you established in the initial steps.

The following instructions assume that you have already created packages, custom storage classes, and memory sections, as described in “Design Custom Storage Classes and Memory Sections” on page 10-8.

Apply Custom Storage Classes to Parameters

To apply a custom storage class to a parameter, you specify the storage class in the `Simulink.Parameter` object that defines the parameter in the base workspace. The instructions that begin in this section show you how to create that object using the GUI or API. Later instructions show you how to specify a custom storage class and custom attributes.

For information about using parameter objects to specify block parameter values, see “Use Parameter Objects to Specify Parameter Values”. For information about parameter storage in generated code, see “Parameters”.

Create Parameter Objects Using GUI

- 1 In the Model window, choose **View > Model Explorer**.
- 2 In the **Model Hierarchy** pane, select the Base Workspace.
- 3 Click the **Add Parameter** tool  or choose **Add > Simulink Parameter**.

Simulink creates a `Simulink.Parameter` object in the base workspace with the default name, `Param`.

- 4 Change the parameter name by editing it in the **Contents** pane. Example: `MyParam`.
- 5 Set parameter attributes other than **Code generation options** in the **Dialog** pane.
- 6 Follow the instructions in “Specify Custom Storage Classes Using GUI” on page 10-46.

Create Parameter Objects Using API

- 1 In the MATLAB Command Window, enter:

```
ParamName=ParamClass
```

where *ParamClass* is `Simulink.Parameter` or a subclass of it that you have defined.

- 2 Simulink creates a *ParamClass* object with the specified name:

```
MyParam =  
  
Simulink.Parameter (handle)  
    Value: []  
    CoderInfo: [1x1 Simulink.ParamCoderInfo]  
    Description: ''  
    DataType: 'auto'  
    Min: []  
    Max: []  
    DocUnits: ''  
    Complexity: 'real'  
    Dimensions: [0 0]
```

- 3 Set parameter attributes other than `CoderInfo`, which controls custom storage classes.
- 4 Follow the instructions in “Specify Custom Storage Classes Using API” on page 10-48.

Apply Custom Storage Classes to Signals

To apply a custom storage class to a signal, you specify the storage class in a `Simulink.Signal` object. This object can exist in either of two locations:

- In the MATLAB base workspace
- On the port where the signal originates

The object itself is the same in either case; only its location and some of the techniques for managing it differ. The instructions that begin in this section show you how to create a signal object in either location using the GUI or API. Later instructions show you how to specify the custom storage class and custom attributes.

A given signal can be associated with at most one signal object. The signal can refer to the object more than once, but every reference must resolve to exactly the same object. A different signal object that has exactly the same properties will not meet the requirement for uniqueness. A compile-time error occurs if a model associates more than one signal object with a signal.

Assigning a signal to a non-Auto storage class automatically makes the signal a test point, overriding the setting of **Signal Properties > Logging and accessibility > Test point**. See “Test Points” for more information.

For information about using signal objects to specify signal attributes, see “Using Signal Objects to Initialize Signals and Discrete States”. For information about signal storage in generated code, see “Signals”.

Custom Storage Classes Using Signal Objects

The first step is to create the signal object in the base workspace, after which you specify signal attributes and the custom storage class and attributes.

Create Signal Objects in Base Workspace Using GUI

- 1 In the Simulink Editor, select **View > Model Explorer**.
- 2 In the **Model Hierarchy** pane, select the Base Workspace.
- 3 Click the **Add Signal** tool  or choose **Add > Simulink Signal**.

Simulink creates a `Simulink.Signal` object in the base workspace, with a default name, `Sig`.

- 4 Change the signal name by editing it in the **Contents** pane. Example: `MySig`.
- 5 Set signal attributes other than **Code generation options** in the **Dialog** pane.
- 6 Give the signal the same name as the signal object, as described in “Signal Names”.

- 7 Arrange for the signal to resolve to the object, as described in “Symbol Resolution”.
- 8 Follow the instructions in “Specify Custom Storage Classes Using GUI” on page 10-46.

Create Signal Objects in Base Workspace Using API

- 1 In the MATLAB Command Window, enter:

```
SignalName=SignalClass
```

where *SignalClass* is `Simulink.Signal` or a subclass of it that you have defined.

- 2 Simulink creates a *SignalClass* object with the specified name:

```
MySig =
```

```
Simulink.Signal (handle)  
  CoderInfo: [1x1 Simulink.SignalCoderInfo]  
  Description: ''  
  DataType: 'auto'  
  Min: []  
  Max: []  
  DocUnits: ''  
  Dimensions: -1  
  Complexity: 'auto'  
  SampleTime: -1  
  SamplingMode: 'auto'  
  InitialValue: ''
```

- 3 Set parameter attributes other than `CoderInfo`, which controls custom storage classes.
- 4 Give the signal the same name as the signal object, as described in “Signal Names”.
- 5 Arrange for the signal to resolve to the object, as described in “Symbol Resolution”.

- 6 Follow the instructions in “Specify Custom Storage Classes Using API” on page 10-48.

Custom Storage Classes Using Embedded Signal Objects

You can use the GUI or the API to apply a CSC using an embedded signal object.

- If you use the GUI, you use the Signal Properties dialog box to specify the attributes you want. The software then creates a `Simulink.Signal` object and assigns it to the output port where the signal originates.
- If you use the API, you instantiate `Simulink.Signal` or a subclass of it, set the attribute values that you want, and assign the object to the output port where the signal originates.

In either case, the generated code is the same as if you had created a base workspace signal object that specified the same name, CSC, and custom attributes as the embedded signal object. For more information, see “Custom Storage Classes Using Signal Objects” on page 10-37.

The advantages of using embedded signal objects are that they do not clutter the base workspace, and they do not need to be saved separately from the model, as base workspace objects do. When you save a model, Simulink saves embedded signal objects in the model file, and reloads the objects when you later reload the model.

The disadvantage of embedded signal objects is that you can use such an object *only* to specify a custom storage class, custom attributes, and an alias; you must accept the default values for other signal attributes. You cannot work around this restriction by providing additional information in a base workspace signal object on the same signal, because a signal object can have at most one associated signal object, as described in “Multiple Signal Objects”.

Create Embedded Signal Objects Using GUI

- 1 Give the signal a name, which must be a valid ANSI C identifier. Example: `MySig`.

- 2 Right-click the signal and choose **Properties** from the context menu.

The Signal Properties dialog box opens:

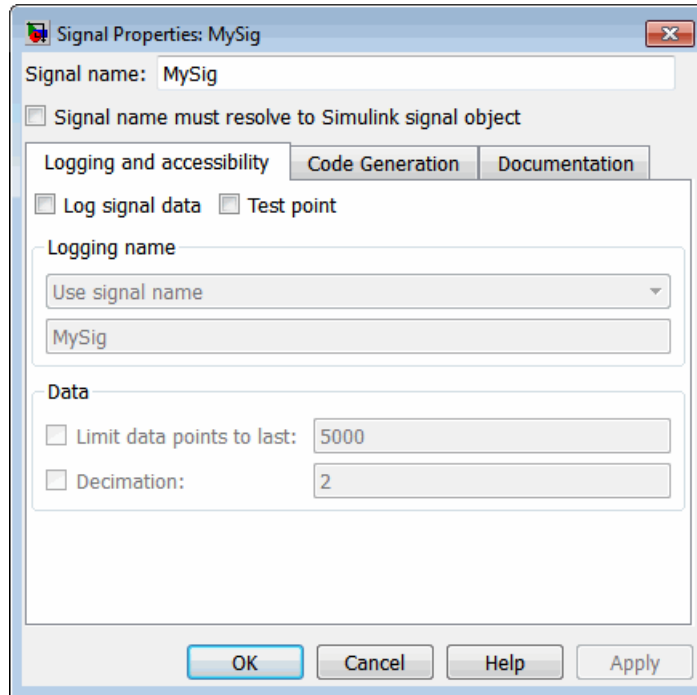

- 3 *Do not* select **Signal name must resolve to Simulink signal object**. Selecting it would require a base workspace signal object, which would conflict with the embedded signal object.
- 4 Click the **Code Generation** tab.
- 5 The **Package** is initially ---None---. When a package is not specified, only the non-custom built-in storage classes defined for both GRT and ERT targets are available:

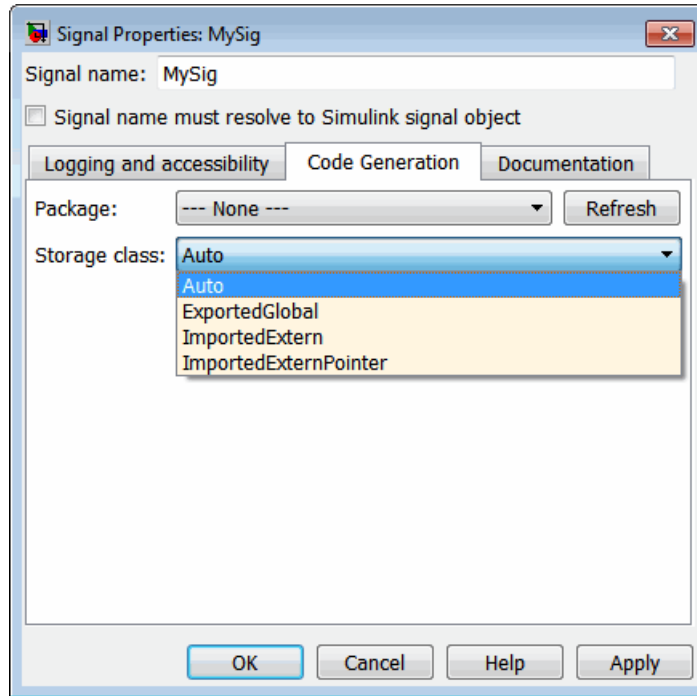

Applying a storage class when the package is ---None--- sets internal storage class attributes rather than creating an embedded signal object. For information about built-in storage classes, see “Signals” in the Simulink Coder documentation.

- 6 To apply a custom storage class, you must first specify the package where it is defined. Initially, viewing the **Package** menu displays only the built-in Simulink and mpt packages:

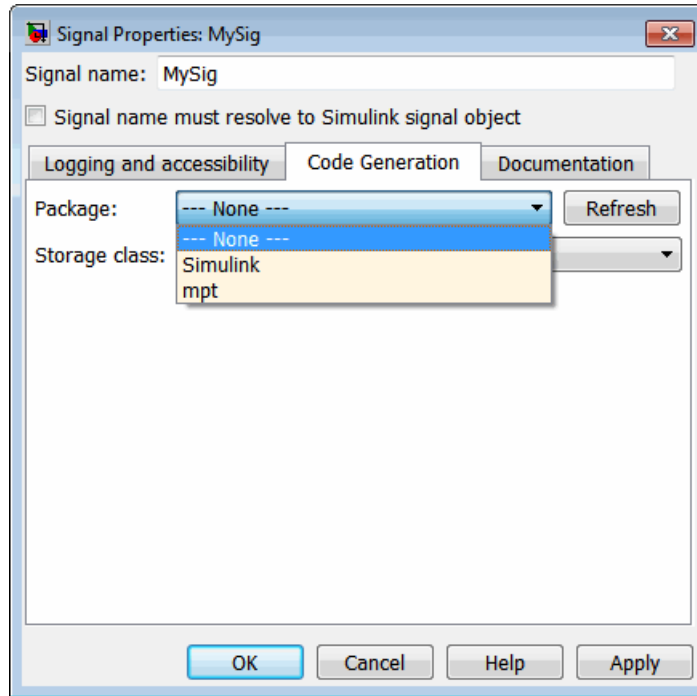

- 7 Click **Refresh** to load other available packages, including user-defined packages, available on the MATLAB path. After a brief delay, a timer box tracks the progress of the package search. After the search completes, viewing the **Package** menu displays available packages:

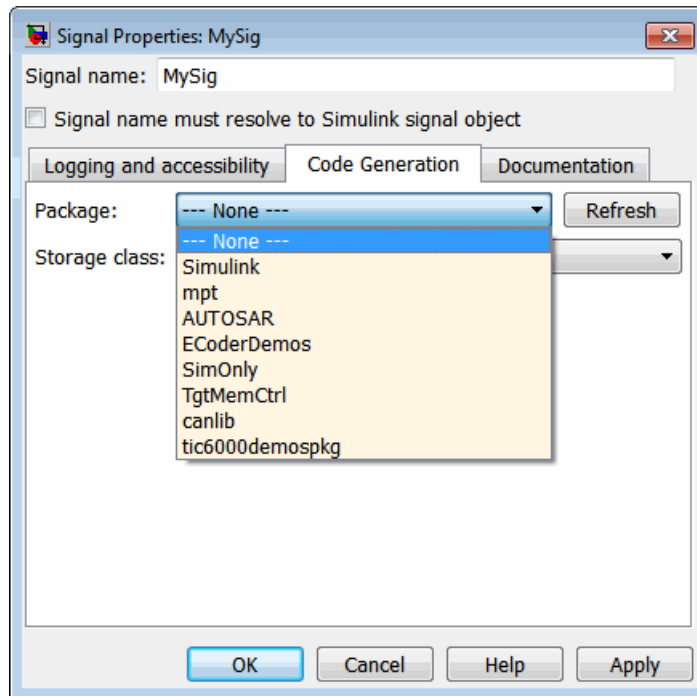

Once you have used **Refresh** in the Signal Properties dialog, Simulink saves the information for later use, so you do not have to click **Refresh** again during the current MATLAB session.

- 8 Select the package that contains the custom storage class you want to apply, e.g. Simulink:

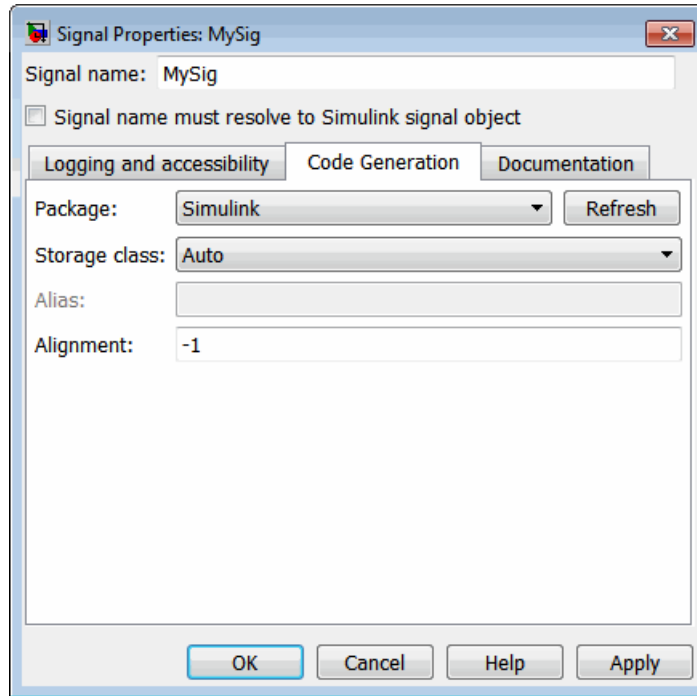

- 9 Follow the instructions in “Specify Custom Storage Classes Using GUI” on page 10-46.

Delete Embedded Signal Objects Using GUI

To delete an embedded signal object with the Model Explorer, delete the name of the signal to which the object applies, by editing the name in the graphical model or in the Signal Properties dialog box. Simulink automatically deletes the embedded signal object as soon as its signal does not have a name.

Create Embedded Signal Objects Using API

To provide an embedded signal object using the API, you create the object, set its custom storage class and custom attributes, then assign the object to the output port on which it will be embedded.

- 1 Name the signal if it does not already have a name. The name must be a valid ANSI C identifier.

- 2** In the MATLAB Command Window, enter:

```
SignalName=SignalClass
```

where *SignalClass* is `Simulink.Signal` or a subclass of it that you have defined. The name of the signal object does not need to match the name of the signal to which the object will be applied.

- 3** Simulink creates a *SignalClass* object with the specified name. Example:

```
MySig =
```

```
Simulink.Signal (handle)
    CoderInfo: [1x1 Simulink.SignalCoderInfo]
    Description: ''
    DataType: 'auto'
    Min: []
    Max: []
    DocUnits: ''
    Dimensions: -1
    Complexity: 'auto'
    SampleTime: -1
    SamplingMode: 'auto'
    InitialValue: ''
```

- 4** *Do not* set attributes. An embedded signal object can specify *only* custom storage class information.
- 5** Follow the instructions in “Specify Custom Storage Classes Using API” on page 10-48. After specifying the custom storage class, be sure to assign the signal object to its output port, as described under “Assign Embedded Signal Objects to Output Ports” on page 10-51.

Change Embedded Signal Objects Using API

To change an embedded signal object using the API, you obtain a copy of the object from the output port on which it is embedded, change the object, then assign the changed object back to the port.

- 1** Obtain a copy of the signal object using a handle to the output port.
Example:

```
hps=get_param(gcb, 'PortHandles')
hp=hps.Outport(1)
MySig=get_param(hp, 'SignalObject')
```

- 2 Change the signal object using the techniques described in “Specify Custom Storage Classes Using API” on page 10-48. After making the changes, be sure to copy the signal object to its output port, as described in “Assign Embedded Signal Objects to Output Ports” on page 10-51.

Delete Embedded Signal Objects Using API

To delete an embedded signal object with the API, obtain a handle to the output port where the signal object is embedded, then set the port’s `SignalObject` parameter to []:

```
hps=get_param(gcb, 'PortHandles')
hp=hps.Outport(1)
set_param(hp, 'SignalObject', [])
```

Resolve Signal Names to Simulink Signal Objects Using API

To set the name of a signal to resolve to a Simulink signal object using the API, obtain the handle to the output port and then set the port’s `MustResolveToSignalObject` property to on:

```
hps=get_param(gcb, 'PortHandles')
hp=hps.Outport(1)
set_param(hp, 'MustResolveToSignalObject', 'on')
```

Specify Custom Storage Classes Using GUI

The initial steps for applying a CSC with the GUI differ depending on whether you are applying the CSC to a parameter using a base workspace object, to a signal using a base workspace object, or to a signal using an embedded object. The initial steps for each of these three cases appear in:

- “Create Parameter Objects Using GUI” on page 10-35
- “Create Signal Objects in Base Workspace Using GUI” on page 10-37
- “Create Embedded Signal Objects Using GUI” on page 10-39

After the initial steps, applying a CSC with the GUI is the same for the three cases. The following instructions show you how to finish applying a CSC with the GUI. The instructions assume that you have completed one of the previous sets of instructions, and that the dialog you used to execute those instructions is still open.

The available custom storage classes and custom attributes depend on the package that you select. The examples in this section assume that you are using the Simulink package.

The dialog that you used to begin the process of applying a CSC with the GUI by providing an object contains two fields: one for specifying a custom storage class and one for optionally specifying an alias.

Storage class is **Auto** because that is the default storage class in the Simulink package. Other packages may have different defaults. You can specify an **Alias** whenever the **Storage class** is not **Auto**. If **Storage class** is **Auto**, Simulink deletes aliases you try to specify, leaving the field blank. If you specify an alias, it appears in generated code instead of the name of the object.

To specify a custom storage class and its custom attributes:

- 1 View the **Storage Class** menu, which looks like this for the Simulink package:

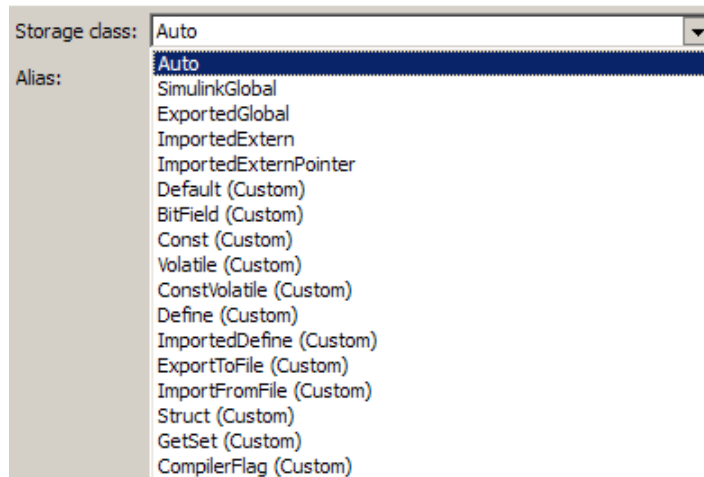

Each custom storage class has (custom) suffixed to its name. The storage classes `SimulinkGlobal`, `ExportedGlobal`, `ImportedExtern`, and `ImportedExternPointer` are the built-in non-custom storage classes described in “Signals” in the Simulink Coder documentation.

- 2 Choose the desired custom storage class from **Storage class**, for example, `Struct`.
- 3 Provide values for custom attributes. `Struct` has only one, **Struct name**. For example, set **Struct name** to `MyStruct`:

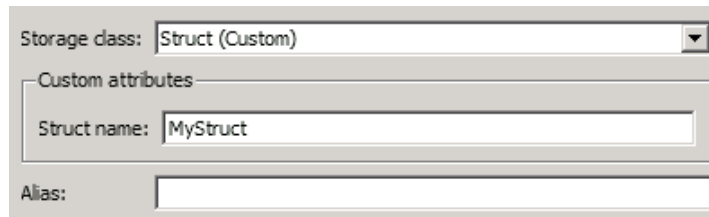

The image shows a configuration dialog for a custom storage class. At the top, there is a dropdown menu labeled 'Storage class:' with 'Struct (Custom)' selected. Below this is a section titled 'Custom attributes' which contains a text input field labeled 'Struct name:' with the value 'MyStruct' entered. At the bottom of the dialog, there is an 'Alias:' label followed by an empty text input field.

- 4 Click **Apply**.

In generated code, data whose storage is controlled by this custom storage class specification will appear in a structure named `MyStruct`. See “Generate Code with Custom Storage Classes” on page 10-53 for an example.

Specify Custom Storage Classes Using API

The initial steps for applying a CSC with the API differ depending on whether you are applying the CSC to a parameter using a base workspace object, to a signal using a base workspace object, or to a signal using an embedded object. The initial steps for each of these three cases appear in:

- “Create Parameter Objects Using API” on page 10-35
- “Create Signal Objects in Base Workspace Using API” on page 10-38
- “Create Embedded Signal Objects Using API” on page 10-44

After the initial steps, applying a CSC with the API is the same for the three cases, except for the case of an assignment for an embedded signal object. The following instructions show you how to finish applying a CSC with the API.

The instructions assume that you have completed one of the previous sets of instructions, and that the resulting objects and attributes are unchanged.

The available custom storage classes and custom attributes depend on the package that you select. The examples in this section assume that you are using the Simulink package. The examples also assume that the object for which you want to specify a custom storage class is named `MyObj`, which is a parameter or signal object that exists in the base workspace, or a signal object that will be assigned to an output port.

The rest of this section provides information that is specific to custom storage classes in Embedded Coder. See “Simulink Package Custom Storage Classes” on page 10-6 for a list of the custom storage classes that are built into the Simulink package for use by Embedded Coder software.

CoderInfo Properties

Each Simulink parameter object or signal object defines properties called `CoderInfo` properties. Code generation software uses these properties to control storage class assignment in the generated code. The `CoderInfo` properties and their default values are as follows:

```
StorageClass: 'Auto'
Alias: ''
CustomStorageClass: 'Default'
CustomAttributes: [1x1 SimulinkCSC.AttribClass_Simulink_Default]
```

For more information about `CoderInfo` properties, see “Signals” in the Simulink Coder documentation.

Specify a Custom Storage Class

To specify a custom storage class using `CoderInfo` properties:

- 1 Set `StorageClass` to `'Custom'`.
- 2 Set `CustomStorageClass` to the name of the storage class.

For example, to specify the Struct custom storage class:

```
MyObj.CoderInfo.StorageClass='Custom'
```

```
MyObj.CoderInfo.CustomStorageClass='Struct'
```

Whenever you have specified a custom storage class other than `Auto`, you can specify an alias by setting the `Alias` attribute. If you specify an alias, it appears in generated code instead of the name of the object.

Specify Instance-Specific Attributes

A custom storage class can have properties that define attributes that are specific to that CSC. Such properties are called **instance-specific attributes**. For example, if you specify the `Struct` custom storage class, you must specify the name of the C language structure that will store the data. That name is an instance-specific attribute of the `Struct` CSC.

Instance-specific attributes are stored in the `CoderInfo.CustomAttributes` property. This property is initially defined as follows:

```
SimulinkCSC.AttribClass_Simulink_Default  
1x1 struct array with no fields
```

When you specify a custom storage class, Simulink automatically populates `CoderInfo.CustomAttributes` with fields to represent instance-specific attributes of that CSC. For example, if you set the `MySig` CSC to `Struct`, as described in “Specify a Custom Storage Class” on page 10-49, then enter:

```
MyObj.CoderInfo.CustomAttributes
```

MATLAB displays:

```
SimulinkCSC.AttribClass_Simulink_Struct  
  StructName: ''
```

To specify that `StructName` is `MyStruct`, enter:

```
MyObj.CoderInfo.CustomAttributes.StructName='MyStruct'
```

MATLAB displays:

```
SimulinkCSC.AttribClass_Simulink_Struct  
  StructName: 'MyStruct'
```

Class Name	Instance-Specific Property	Purpose
BitField	CustomAttributes.StructName	Name of the bitfield struct into which the code generator packs the object's Boolean data.
ExportToFile	CustomAttributes.HeaderFile	Name of header (.h) file that contains exported variable declarations and export directives for the object.
GetSet	CustomAttributes.HeaderFile	Name of header (.h) file to #include in the generated code. See "GetSet Custom Storage Classes" on page 10-61.
	CustomAttributes.GetFunction	String that specifies the name of a function call to read data.
	CustomAttributes.SetFunction	String that specifies the name of a function call to write data.
ImportedDefine	CustomAttributes.HeaderFile	The header file that defines the values of code variant preprocessor conditionals. See "Generate Preprocessor Conditionals for Variant Systems" on page 6-4.
ImportFromFile	CustomAttributes.HeaderFile	Name of header (.h) file containing global variable declarations the code generator imports for the object.
Struct	CustomAttributes.StructName	Name of the struct into which the code generator packs the object's data.

Assign Embedded Signal Objects to Output Ports

If you are operating on an embedded signal object with the API, you must copy the object to the port after providing or changing its `CoderInfo` properties. For example, if `MyObj` is a signal object that you want to copy to the output port, enter:

```
hps=get_param(gcb, 'PortHandles')
hp=hps.Outputport(1)
set_param(hp, 'SignalObject', 'MyObj')
```

Subsequent changes to the source object in the base workspace have no effect on the output port copy, and you can delete the source object:

```
clear ('MyObj')
```

Generate Code with Custom Storage Classes

In this section...

“Code Generation Prerequisites” on page 10-53

“Code Generation With Custom Storage Classes” on page 10-53

Code Generation Prerequisites

Before you generate code for a model that uses custom storage classes, set model options as follows:

- If your model assigns custom storage classes to parameters, select **Configuration Parameters > Optimization > Signals and Parameters > Inline parameters**. Otherwise, the code generator ignores CSC specifications for parameters. This requirement also applies to models that assign built-in storage classes to parameters.
- Clear **Configuration Parameters > Code Generation > Data specification override > Ignore custom storage classes**.

Otherwise, the code generator ignores CSC specifications and treats data objects as if their **Storage class** were Auto.

Code Generation With Custom Storage Classes

This section presents an example of code generation with CSCs, based on this model:

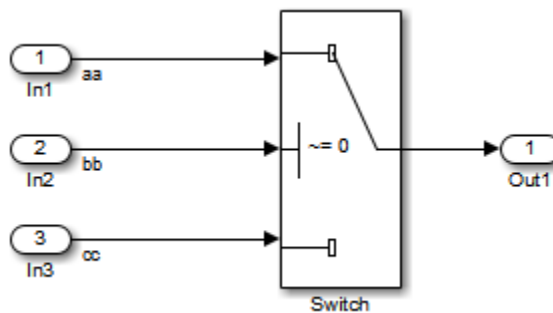

The model contains three named signals: `aa`, `bb`, and `cc`. Using the predefined `Struct` custom storage class, the example generates code that packs these signals into a `struct` named `mySignals`. The `struct` declaration is then exported to externally written code.

To specify the `struct`, you provide `Simulink.Signal` objects that specify the `Struct` custom storage class, and associate the objects with the signals as described in “Apply Custom Storage Classes” on page 10-34. The three objects have the same properties. This figure shows the signal object properties for `aa`:

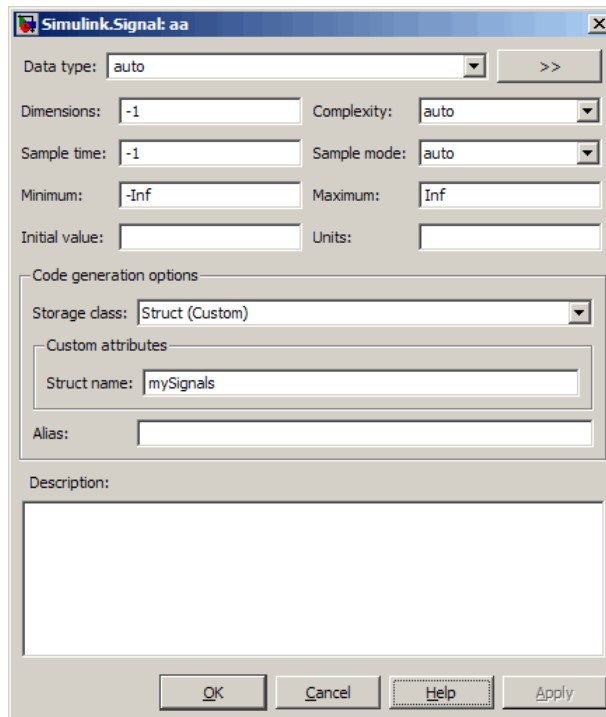

The association between identically named model signals and signal objects is formed as described in “Symbol Resolution”. In this example, the symbols `aa`, `bb`, and `cc` resolve to the signal objects `aa`, `bb`, and `cc`, which have custom storage class `Struct`. In the generated code, storage for the three signals will be allocated within a `struct` named `mySignals`.

You can display the storage class of the signals in the block diagram by selecting **Port/Signal Display > Storage Class** from the Simulink model editor **Format** menu. The figure below shows the block diagram with signal data types and signal storage classes displayed.

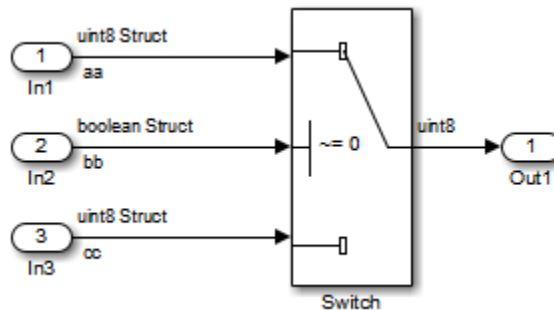

With the model configured as described in “Code Generation Prerequisites” on page 10-53, and the signal objects defined and associated with the signals, you can generate code that uses the custom storage classes to generate the desired data structure for the signals. After code generation, the relevant definitions and declarations are located in three files:

- *model_types.h* defines the following struct type for storage of the three signals:

```
typedef struct MySignals_tag {
    boolean_T cc;
    uint8_T bb;
    uint8_T aa;
} mySignals_type;
```

- *model.c* (or *.cpp*) defines the variable `mySignals`, as specified in the object’s instance-specific `StructName` attribute. The variable is referenced in the code generated for the Switch block:

```
/* Definition for Custom Storage Class: Struct */

mySignals_type mySignals = {
    /* cc */
    FALSE,
```

```
/* bb */
0,
/* aa */
0
};
...
/* Switch: '<Root>/Switch1' */
if(mySignals.cc) {
    rtb_Switch1 = mySignals.aa;
} else {
    rtb_Switch1 = mySignals.bb;
}
```

- `model.h` exports the `mySignals` Struct variable:

```
/* Declaration for Custom Storage Class: Struct */

extern mySignals_type mySignals;
```

Grouped Custom Storage Classes

A custom storage class that results in multiple data objects being referenced with a single variable in the generated code, in the previous example, is called a *grouped custom storage class*. In the Simulink package, `Bitfield` and `Struct` (shown in the preceding example) are grouped CSCs. Data grouped by a CSC is referred to as *grouped data*.

Note If you use a grouped custom storage class, you cannot specify its properties on an instance-specific basis. This is because a grouped custom storage class combines multiple pieces of data into a single data structure. Data in this structure must have the same properties such as **Header file**, **Data scope**, and **Data initialization**.

Define Advanced Custom Storage Classes Types

In this section...

“Introduction” on page 10-57

“Create Your Own Parameter and Signal Classes” on page 10-57

“Create Custom Attributes Classes for Custom Storage Classes” on page 10-57

“Write TLC Code for Custom Storage Classes” on page 10-58

“Register Custom Storage Class Definitions” on page 10-58

Introduction

Certain data layouts, such as nested structures, cannot be generated using the standard `Unstructured` and `FlatStructure` custom storage class types. You can define an *advanced custom storage class* if you want to generate other types of data. Creating advanced CSCs requires understanding TLC programming and using a special advanced mode of the Custom Storage Class Designer. This sections explain how to define advanced CSC types.

Create Your Own Parameter and Signal Classes

The first step is to create your own package containing classes derived from `Simulink.Parameter` or `Simulink.Signal`. This procedure is described in “Define Data Classes” in the Simulink documentation.

Create Custom Attributes Classes for Custom Storage Classes

If you have instance-specific properties that are relevant only to your CSC, you should create a *custom attributes class* for the package. A custom attributes class is a subclass of `Simulink.CustomStorageClassAttributes`. The name, type, and default value properties you set for the custom attributes class define the user view of instance-specific properties. For instructions, see “Define Data Classes” in the Simulink documentation.

For example, the `ExportToFile` custom storage class requires that you set the `CoderInfo.CustomAttributes.HeaderFile` property to specify a `.h` file

used for exporting each piece of data. See “Simulink Package Custom Storage Classes” on page 10-6 for further information on instance-specific properties.

Note If you rename or remove custom attributes, you may need to manually edit the `csc_registration` file for the associated package to remove references to the custom attributes that you renamed or removed.

Write TLC Code for Custom Storage Classes

The next step is to write TLC code that implements code generation for data of your new custom storage class. A template TLC file is provided for this purpose. To create your TLC code, follow these steps:

- 1 Create a `tlc` directory inside your package’s `+directory` (if it does not already exist). The naming convention to follow is

`+PackageName/tlc`

- 2 Copy `TEMPLATE_v1.tlc` (or another CSC template) from `matlabroot/toolbox/rtw/targets/ecoder/csc_templates` into your `tlc` directory to use as a starting point for defining your custom storage class.
- 3 Write your TLC code, following the comments in the CSC template file. Comments describe how to specify code generation for data of your custom storage class (for example, how data structures are to be declared, defined, and whether they are accessed by value or by reference).

Alternatively, you can copy a custom storage class TLC file from another existing package as a starting point for defining your custom storage class.

Register Custom Storage Class Definitions

After you have created a package for your new custom storage class and written its associated TLC code, you must register your class definitions with the Custom Storage Class Designer, using its advanced mode.

The advanced mode supports selection of an additional storage class **Type**, designated **Other**. The **Other** type is designed to support special CSC types that cannot be accommodated by the standard **Unstructured** and

FlatStructure custom storage class types. The **Other** type cannot be assigned to a CSC except when the Custom Storage Class Designer is in advanced mode.

To register your class definitions:

- 1 Launch the Custom Storage Class Designer in advanced mode by typing the following command at the MATLAB prompt:

```
cscdesigner -advanced
```

- 2 Select your package and create a new custom storage class.
- 3 Set the **Type** of the custom storage class to **Other**. Note that when you do this, the **Other Attributes** pane is displayed. This pane is visible only for CSCs whose **Type** is set to **Other**.

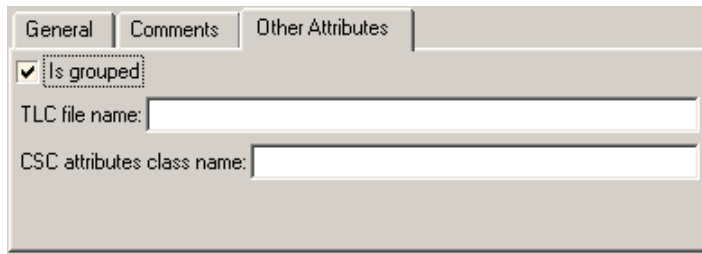

If you specify a customized package, additional options, as defined by the package, also appear on the **Other Attributes** pane.

- 4 Set the properties shown on the **Other Attributes** pane. The properties are:
 - **Is grouped:** Select this option if you intend to combine multiple data objects of this CSC into a single variable in the generated code. (for example, a struct).
 - **TLC file name:** Enter the name of the TLC file corresponding to this custom storage class. The location of the file is assumed to be in the `/t1c` subdirectory for the package, so you should not enter the path to the file.
 - **CSC attributes class name:** (optional) If you created a custom attributes class corresponding to this custom storage class, enter the full

name of the custom attributes class. (see “Create Custom Attributes Classes for Custom Storage Classes” on page 10-57).

- 5 Set the remaining properties on the **General** and **Comments** panes based on the layout of the data that you wish to generate (as defined in your TLC file).

GetSet Custom Storage Classes

In this section...

“About GetSet Custom Storage Class” on page 10-61

“GetSet Custom Storage Class Properties” on page 10-61

“Apply the GetSet Custom Storage” on page 10-62

“GetSet Custom Storage Class Restrictions” on page 10-62

“Increase Code Efficiency With GetSet CSC” on page 10-63

About GetSet Custom Storage Class

GetSet is a built-in advanced custom storage class that generates specialized function calls to read from (get) and write to (set) the memory associated with a Data Store Memory block that is read and written many times in a single model. See “Data Stores” for information about data stores and the Data Store Memory block, and for information about advanced CSCs.

The GetSet custom storage class is designed primarily for use with the state of the Data Store Memory block. However, GetSet is capable of handling signals other than data stores, and is supported for the outputs of most built-in blocks provided by MathWorks. For more about the definition of the GetSet storage class, look at its associated TLC code in the file:

```
matlabroot\toolbox\simulink\simulink\@Simulink\tlc\GetSet.tlc
```

GetSet Custom Storage Class Properties

The next table summarizes the instance-specific properties of the GetSet storage class:

Property	Description
GetFunction	String that specifies the name of a function call to read data.
SetFunction	String that specifies the name of a function call to write data.
HeaderFile (optional)	String that specifies the name of a header (.h) file to add as an <code>#include</code> in the generated code.

For example, if the `GetFunction` of signal `X` is specified as `'get_X'` then the generated code calls `get_X()` wherever the value of `X` is used. Similarly, if the `SetFunction` of signal `X` is specified as `'set_X'` then the generated code calls `set_X(value)` wherever the value of `X` is assigned.

Apply the GetSet Custom Storage

The `GetSet` storage class cannot be represented by the standard `Unstructured` or `FlatStructure` custom storage class types, so it is an advanced CSC, as described in “Define Advanced Custom Storage Classes Types” on page 10-57. To access the CSC definition for `GetSet`, you must launch Custom Storage Class designer in advanced mode:

```
cscdesigner -advanced
```

If you omit the `HeaderFile` property for a `GetSet` data object, you must specify a header file by an alternative means, such as the **Header file** field of the **Code Generation > Custom Code** pane of the Configuration Parameters dialog box. Otherwise, the generated code might not compile or might function improperly.

For wide signals, an additional index argument is passed, so the calls to the get and set functions are `get_X(idx)` and `set_X(idx, value)` respectively.

GetSet Custom Storage Class Restrictions

- The `GetSet` supports only signals of noncomplex data types.
- Some built-in blocks do not directly support `GetSet`.
- User-written S-functions do not directly support `GetSet`.

To use GetSet with a nonsupporting built-in block or a user-written S-function:

- 1 Insert a Signal Conversion block at the output of the block or function.
- 2 Select the Signal Conversion Block's **Exclude this block from 'Block reduction' optimization** property.
- 3 Assign the GetSet storage class to the output of the Signal Conversion block.

Increase Code Efficiency With GetSet CSC

The model below contains a Data Store Memory block that resolves to the Simulink signal object X:



The following specifications configure the signal object X to use the GetSet custom storage class:

```
X = Simulink.Signal;
X.CoderInfo.StorageClass           = 'Custom';
X.CoderInfo.CustomStorageClass    = 'GetSet';
X.CoderInfo.CustomAttributes.GetFunction = 'get_X';
X.CoderInfo.CustomAttributes.SetFunction = 'set_X';
X.CoderInfo.CustomAttributes.HeaderFile  = 'user_file.h';
```

The GetSet CSC appears as follows in the code generated for the model:

```
/* Includes for objects with custom storage classes. */
#include "user_file.h"

void getset_csc_step(void)
{
    /* local block i/o variables */
    real_T rtb_DSRead_o;
```

```
/* DataStoreWrite: '<Root>/DSWrite' incorporates:  
 *   Inport: '<Root>/In1'  
 */  
set_X(getset_csc_U.In1);  
  
/* DataStoreRead: '<Root>/DSRead' */  
rtb_DSRead_o = get_X();  
  
/* Outport: '<Root>/Out1' */  
getset_csc_Y.Out1 = rtb_DSRead_o;  
}
```

Note that the code uses a local variable `rtb_DSRead_o` rather than multiple calls to the `get_X` function. This technique increases code efficiency and prevents changes to the value within a simulation step.

Custom Storage Class Implementation

You can skip this section unless you want to ship custom storage class definitions in an uneditable format, or you intend to bypass the Custom Storage Class designer and work directly with files that contain custom storage class definitions.

The file that defines a package's custom storage classes is called a *CSC registration file*. The file is named `csc_registration` and resides in the `+package` directory that defines the package. A CSC registration file can be a P-file (`csc_registration.p`) or a MATLAB file (`csc_registration.m`). A built-in package defines custom storage classes in both a P-file and a functionally equivalent MATLAB file. A user-defined package initially defines custom storage classes only in a MATLAB file.

P-files take precedence over MATLAB files, so when MATLAB looks for a package's CSC registration file and finds both a P-file and a MATLAB file, MATLAB loads the P-file and ignores the MATLAB file. The capabilities and tools, including the Custom Storage Class Designer, then use the CSC definitions stored in the P-file. P-files cannot be edited, so CSC Designer editing capabilities are disabled for CSCs stored in a P-file. If a P-file does not exist, MATLAB loads CSC definitions from the MATLAB file. MATLAB files are editable, so CSC Designer editing capabilities are enabled for CSCs stored in a MATLAB file.

Because CSC definitions for a built-in package exist in both a P-file and a MATLAB file, they are uneditable. You can make the definitions editable by deleting the P-file, but it is not recommended to modify built-in CSC registration files or other files under `matlabroot`. The preferred technique is to create packages, data classes, and custom storage classes, as described in "Define Data Classes" in the Simulink documentation.

The CSC Designer saves CSC definitions for user-defined packages in a MATLAB file, so the definitions are editable. You can make the definitions uneditable by using the `pcode` function to create an equivalent P-file, which will then shadow the MATLAB file. However, you should preserve the MATLAB file if you may need to make further changes, because you cannot modify CSC definitions that exist only in a P-file.

You can also use tools or techniques other than the Custom Storage Class Designer to create and edit MATLAB files that define CSCs. However, that practice is vulnerable to syntax errors and can give unexpected results. When MATLAB finds an older P-file that shadows a newer MATLAB file, it displays a warning in the MATLAB Command Window.

Custom Storage Class Limitations

- Data objects cannot have a CSC and a multi-word data type.
- The Fcn block does not support parameters with custom storage class in code generation.
- For CSCs in models that use referenced models:
 - If data is assigned a grouped CSC, such as `Struct` or `Bitfield`, the CSC's **Data scope** property must be `Imported` and the data declaration must be provided in a user-supplied header file. See “Grouped Custom Storage Classes” on page 10-56 for more information about grouped CSCs.
 - If data is assigned an ungrouped CSC, such as `Const`, and the data's **Data scope** property is `Exported`, its **Header file** property must be unspecified. This results in the data being exported with the standard header file, `model.h`. Note that for ungrouped data, the **Data scope** and **Header file** properties are either specified by the selected CSC, or as one of the data object's instance-specific properties.

User Package Registration

- “About Data Object Wizard and User Packages” on page 11-2
- “Register User Packages Using sl_customization.m” on page 11-3
- “User Package Customization Using sl_customization.m” on page 11-5

About Data Object Wizard and User Packages

Data Object Wizard (DOW) can be run in connection with a Simulink model to quickly determine which model data are not associated with data objects and to create and associate data objects with the data. (For more information about Data Object Wizard, see “Data Object Wizard” in the Simulink documentation and “Create Data Objects with Data Object Wizard” on page 8-57.) If you want the wizard to use data object classes from a package other than the standard Simulink class package to create the data objects, you select the package from the wizard’s **Choose package for selected data objects** list. You can customize the package list by adding and removing packages and modifying the list order.

Note User-defined packages that you add to the list must contain a `Simulink.Signal` subclass named `Signal` and a `Simulink.Parameter` subclass named `Parameter`.

To register Data Object Wizard user package customizations, use the Simulink customization file `sl_customization.m`. This file is a mechanism that allows you to use MATLAB code to perform customizations of the standard Simulink user interface. The Simulink software reads the `sl_customization.m` file, if present on the MATLAB path, when it starts and the customizations specified in the file are applied to the Simulink session. For more information on the `sl_customization.m` customization file, see “Registering Customizations”.

Register User Packages Using sl_customization.m

To register Data Object Wizard user package customizations, you create an instance of `sl_customization.m` and include it on the MATLAB path of the Simulink installation that you want to customize. The `sl_customization` function accepts one argument: a handle to a customization manager object. For example,

```
function sl_customization(cm)
```

As a starting point for your customizations, the `sl_customization` function must first get the default (factory) customizations, using the following assignment statement:

```
hObj = cm.slDataObjectCustomizer;
```

You then invoke methods to register your customizations. The customization manager object includes the following methods for registering DOW user package customizations:

- `addUserPackage(hObj, packageName)`
`addUserPackage(hObj, cellArrayOfStrings)`
Adds the specified user package(s) to the top of the package list, as displayed in the **Choose package for selected data objects** pull-down list in Data Object Wizard.
- `moveUserPackageToTop(hObj, packageName)`
Moves the specified user package to the top of the package list, as displayed in the **Choose package for selected data objects** pull-down list in Data Object Wizard.
- `moveUserPackageToEnd(hObj, packageName)`
Moves the specified user package to the end of the package list, as displayed in the **Choose package for selected data objects** pull-down list in Data Object Wizard.
- `removeUserPackage(hObj, packageName)`
Removes the specified user package from the package list.
- `setUserPackages(hObj, cellArrayOfStrings)`

Replaces the entire package list with a specified list of user packages.

Your instance of the `sl_customization` function should use these methods to register DOW user package customizations for your Simulink installation.

The Simulink software reads the `sl_customization.m` file when it starts. If you subsequently change the file, in order to use your changes, you must restart your Simulink session or enter the following command at the MATLAB command line:

```
sl_refresh_customizations
```

User Package Customization Using sl_customization.m

The sl_customization.m file shown in sl_customization.m for User Package Customizations on page 11-5 uses the following methods:

- addUserPackage to add the user packages ECoderDemos and SimulinkDemos (present by default in the MATLAB path) to the top of the package list, as displayed in the **Choose package for selected data objects** pull-down list in Data Object Wizard

Note Packages ECoderDemos and SimulinkDemos must contain a Simulink.Signal subclass named Signal and a Simulink.Parameter subclass named Parameter.

- moveUserPackageToEnd to move SimulinkDemos to the end of the package list

sl_customization.m for User Package Customizations

```
function sl_customization(cm)
% Register user customizations

% Get default (factory) customizations
hObj = cm.slDataObjectCustomizer;

% Add user packages
hObj.addUserPackage({'ECoderDemos', 'SimulinkDemos'});

% Move SimulinkDemos to end of list
hObj.moveUserPackageToEnd('SimulinkDemos');

end
```

If you include the above file on the MATLAB path of the Simulink installation that you want to customize, the specified customizations will appear in Data Object Wizard. For example, you could view the customizations as follows:

- 1 Start a MATLAB session.
- 2 Launch a model, such as `rtwdemo_udt`.
- 3 Open Data Object Wizard, for example, by selecting **Code > Data Objects > Data Object Wizard** in the Simulink window.
- 4 In the Data Object Wizard dialog box, click the **Find** button to generate a list of one or more data objects.
- 5 Examine the **Choose package for selected data objects** drop-down list, noting the impact of the changes specified in `sl_customization.m` for User Package Customizations on page 11-5.

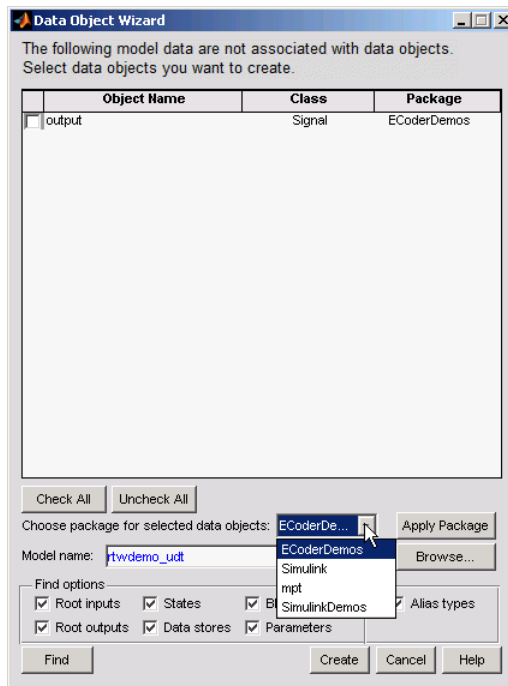

To replace the entire Data Object Wizard package list with a specified list of user packages, you can use a method invocation similar to the following:

```
hObj.setUserPackages({'myPackage1', 'ECoderDemos', 'mpt'});
```

Function and Class Interfaces

- “Function Prototype Control” on page 12-2
- “C++ Encapsulation Interface Control” on page 12-24
- “Atomic Subsystem Code” on page 12-49

Function Prototype Control

In this section...

“About Function Prototype Control” on page 12-2

“Configure Function Prototypes Using Graphical Interfaces” on page 12-3

“Sample Procedure for Configuring Function Prototypes” on page 12-11

“Configure Function Prototypes Programmatically” on page 12-16

“Sample Script for Configuring Function Prototypes” on page 12-20

“Verify Generated Code for Customized Functions” on page 12-21

“Function Prototype Control Limitations” on page 12-21

About Function Prototype Control

The Embedded Coder software provides a **Configure Model Functions** button, located on the **Code Generation > Interface** pane of the Configuration Parameters dialog box, that allows you to control the model function prototypes that are generated for ERT-based Simulink models.

By default, the function prototype of an ERT-based model’s generated *model_step* function resembles the following:

```
void model_step(void);
```

The function prototype of an ERT-based model’s generated *model_initialize* function resembles the following:

```
void model_initialize(void);
```

(For more detailed information about the default calling interface for the *model_step* function, see the *model_step* reference page.)

The **Configure Model Functions** button on the **Interface** pane provides you flexible control over the model function prototypes that are generated for your model. Clicking **Configure Model Functions** launches a Model Interface dialog box (see “Configure Function Prototypes Using Graphical Interfaces” on page 12-3). Based on the **Function specification** value you specify for your model function (supported values include `Default model initialize` and

step functions and Model specific C prototypes), you can preview and modify the function prototypes. Once you validate and apply your changes, you can generate code based on your function prototype modifications.

For more information about using the **Configure Model Functions** button and the Model Interface dialog box, see “Sample Procedure for Configuring Function Prototypes” on page 12-11 and the model `rtwdemo_fcncnprotoctrl`, which is preconfigured to demonstrate function prototype control.

Alternatively, you can use function prototype control functions to programmatically control model function prototypes. For more information, see “Configure Function Prototypes Programmatically” on page 12-16.

You can also control model function prototypes for nonvirtual subsystems, if you generate subsystem code using right-click build. To launch the **Model Interface for subsystem** dialog box, use the `RTW.configSubsystemBuild` function.

Right-click building the subsystem generates the step and initialization functions according to the customizations you make. For more information, see “Configure Function Prototypes for Nonvirtual Subsystems” on page 12-8.

For limitations that apply, see “Function Prototype Control Limitations” on page 12-21.

Configure Function Prototypes Using Graphical Interfaces

- “Launch the Model Interface Dialog Boxes” on page 12-3
- “Default Model Initialize and Step Functions View” on page 12-4
- “Model Specific C Prototypes View” on page 12-5
- “Configure Function Prototypes for Nonvirtual Subsystems” on page 12-8

Launch the Model Interface Dialog Boxes

Clicking the **Configure Model Functions** button on the **Interface** pane of the Configuration Parameters dialog box launches the Model Interface dialog box. This dialog box is the starting point for configuring the model function

prototypes that are generated during code generation for ERT-based Simulink models. Based on the **Function specification** value you select for your model function (supported values include Default model initialize and step functions and Model specific C prototypes), you can preview and modify the function prototype. Once you validate and apply your changes, you can generate code based on your function prototype modifications.

To configure function prototypes for a right-click build of a nonvirtual subsystem, invoke the `RTW.configSubsystemBuild` function, which launches the Model Interface for subsystem dialog box. For more information, see “Configure Function Prototypes for Nonvirtual Subsystems” on page 12-8

Default Model Initialize and Step Functions View

The figure below shows the Model Interface dialog box in the Default model initialize and step functions view.

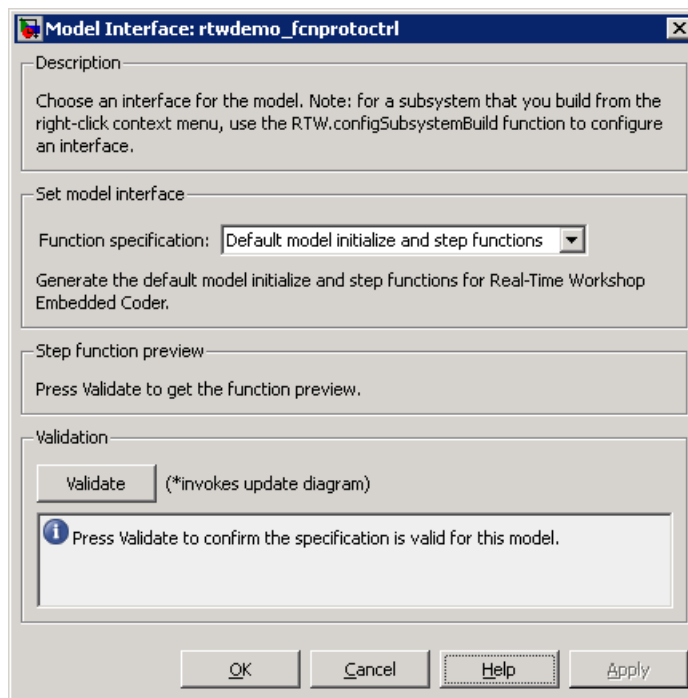

The **Default model initialize and step functions** view allows you to validate and preview the predicted default model step and initialization function prototypes. To validate the default function prototype configuration against your model, click the **Validate** button. If the validation succeeds, the predicted step function prototype appears in the **Step function preview** subpane.

Note You cannot use the **Default model initialize and step functions** view to modify the function prototype configuration.

Model Specific C Prototypes View

Selecting **Model specific C** prototypes for the **Function specification** parameter displays the **Model specific C** prototypes view of your model function prototypes. This view provides controls that you can use to customize the function names, the order of arguments, and argument attributes including name, passing mechanism, and type qualifier for each of the model's root-level I/O ports.

To begin configuring your function control prototype configuration, click the **Get Default Configuration** button. This activates and initializes the function names and properties in the **Configure model initialize and step functions** subpane, as shown below. If you click **Get Default Configuration** again later, only the properties of the step function arguments are reset to default values.

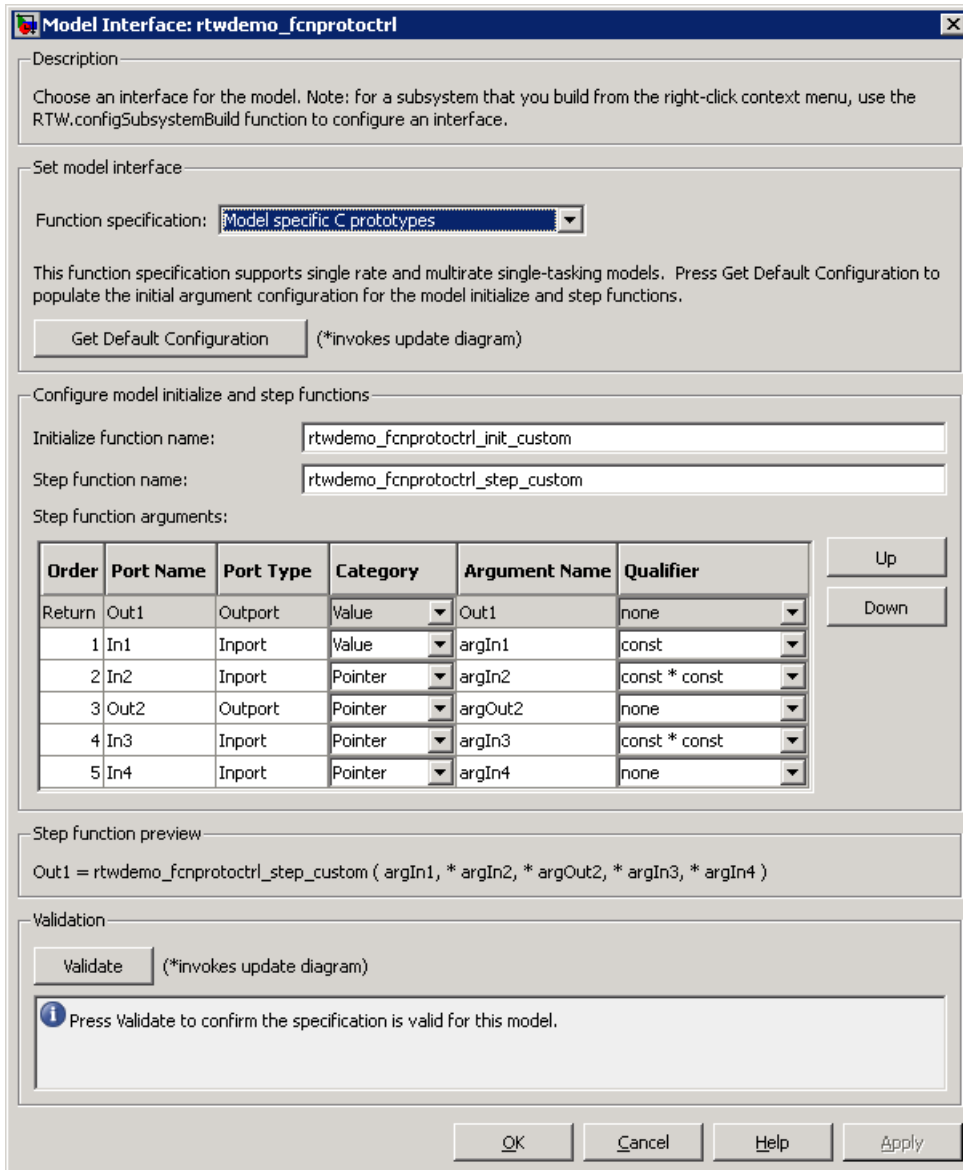

In the **Configure model initialize and step functions** subpane:

Parameter	Description
Step function name	Name of the <i>model_step</i> function.
Initialize function name	Name of the <i>model_initialize</i> function.
Order	Order of the argument. A return argument is listed as Return .
Port Name	Name of the port.
Port Type	Type of the port.
Category	Specifies how an argument is passed in or out from the customized step function, either by copying a value (Value) or by a pointer to a memory space (Pointer).
Argument Name	Name of the argument.
Qualifier (optional)	<p>Specifies a const type qualifier for a function argument. The available values are dependent on the Category specified. When you change the Category, if the specified type is not available, the Qualifier changes to none. The possible values are:</p> <ul style="list-style-type: none"> • none • const (value) • const* (value referenced by the pointer) • const*const (value referenced by the pointer and the pointer itself)

Parameter	Description
	<p>Tip When a model includes a referenced model, the <code>const</code> type qualifier for the root input argument of the referenced model's specified step function interface is set to <code>none</code>, and the qualifier for the source signal in the referenced model's parent is set to a value other than <code>none</code>, code generation honors the referenced model's interface specification by generating a type cast that discards the <code>const</code> type qualifier from the source signal. To override this behavior, add a <code>const</code> type qualifier to the referenced model.</p>

The **Step function preview** subpane provides a preview of how your step function prototype is interpreted in generated code. The preview is updated dynamically as you make modifications.

An argument `foo` whose **Category** is `Pointer` is previewed as `* foo`. If its **Category** is `Value`, it is previewed as `foo`. Notice that argument types and qualifiers are not represented in the **Step function preview** subpane.

Configure Function Prototypes for Nonvirtual Subsystems

You can control step and initialization function prototypes for nonvirtual subsystems in ERT-based Simulink models, if you generate subsystem code using right-click build. Function prototype control is supported for the following types of nonvirtual blocks:

- Triggered subsystems
- Enabled subsystems
- Enabled trigger subsystems
- While subsystems
- For subsystems
- Stateflow blocks

- MATLAB function block

To launch the Model Interface for Subsystem dialog box, open the model containing the subsystem and invoke the `RTW.configSubsystemBuild` function.

The Model Interface dialog box for modifying the model-specific C prototypes for the `rtwdemo_counter/Amplifier` subsystem appears as follows:

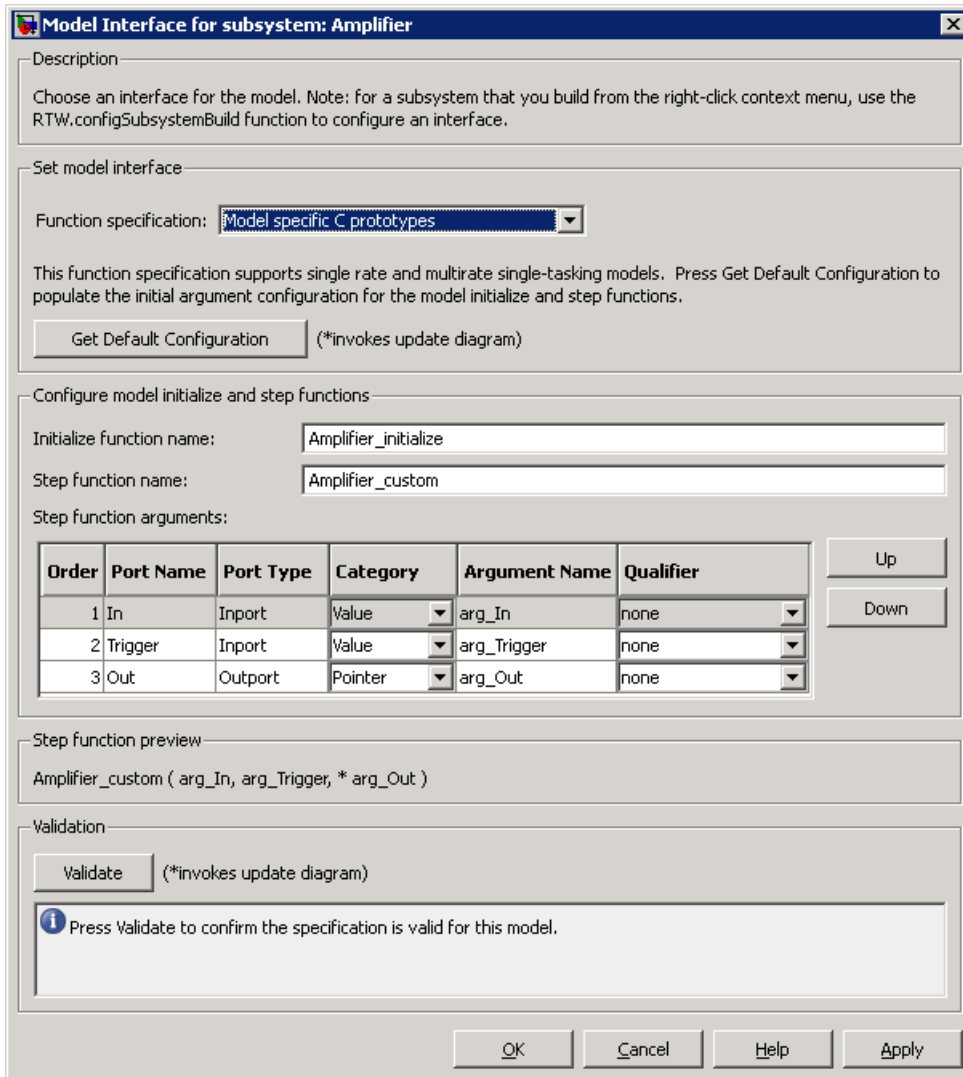

Right-click building the subsystem generates the step and initialization functions according to the customizations you make.

Sample Procedure for Configuring Function Prototypes

The following procedure shows how to use the **Configure Model Functions** button on the **Code Generation > Interface** pane of the Configuration Parameters dialog box to control the model function prototypes when generating code for your Simulink model.

- 1 Open a MATLAB session and launch the `rtwdemo_counter` model.
- 2 In the `rtwdemo_counter` Model Editor, double-click the **Generate Code Using Embedded Coder (double-click)** button to generate code for an ERT-based version of `rtwdemo_counter`. The code generation report for `rtwdemo_counter` appears.
- 3 In the code generation report, click the link for `rtwdemo_counter.c`.
- 4 In the `rtwdemo_counter.c` code display, locate and examine the generated code for the `rtwdemo_counter_step` and the `rtwdemo_counter_initialize` functions:

```
/* Model step function */
void rtwdemo_counter_step(void)
{
    ...
}

/* Model initialize function */
void rtwdemo_counter_initialize(void)
{
    ...
}
```

You can close the report window after you have examined the generated code. Optionally, you can save `rtwdemo_counter.c` and other generated files to a different location for later comparison.

- 5 From the `rtwdemo_counter` model, open the Configuration Parameters dialog box.

- 6 Navigate to the **Code Generation > Interface** pane and click the **Configure Model Functions** button. The Model Interface dialog box appears.
- 7 In the initial (Default model initialize and step functions) view of the Model Interface dialog box, click the **Validate** button to validate and preview the default function prototype for the `rtwdemo_counter_step` function. The function prototype arguments under **Step function preview** should correspond to the default prototype in step 4.

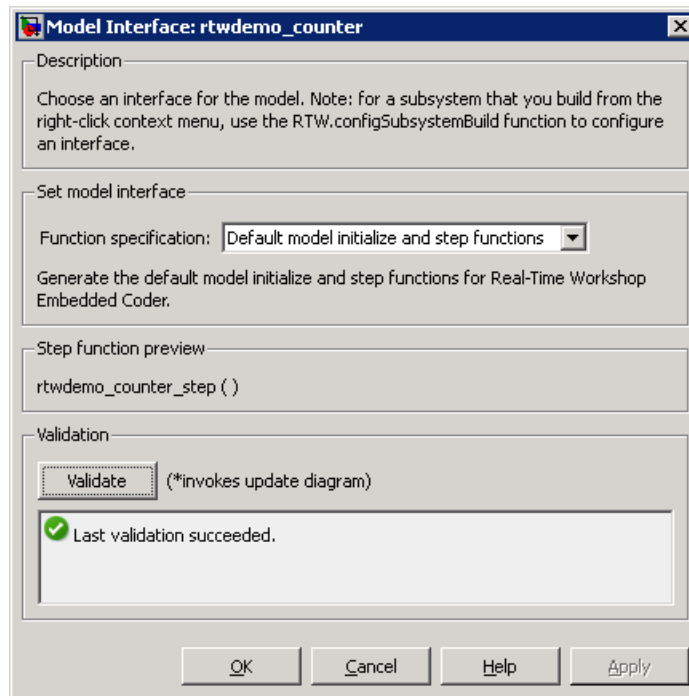

- 8 In the Model Interface dialog box, set **Function specification** field to Model specific C prototypes. Making this selection switches the dialog box from the Default model initialize and step functions view to the Model specific C prototypes view.

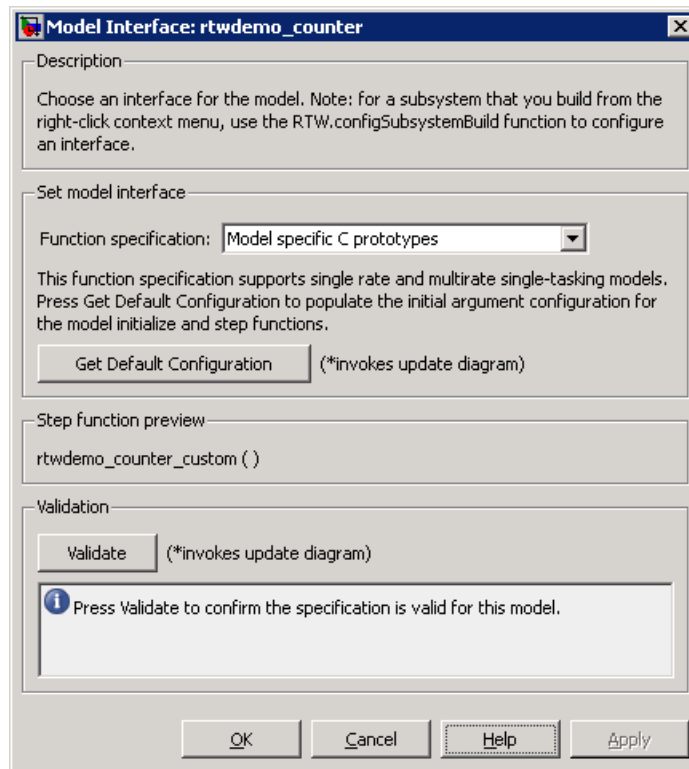

- 9 In the Model specific C prototypes view, click the **Get Default Configuration** button to activate the **Configure model initialize and step functions** subpane.

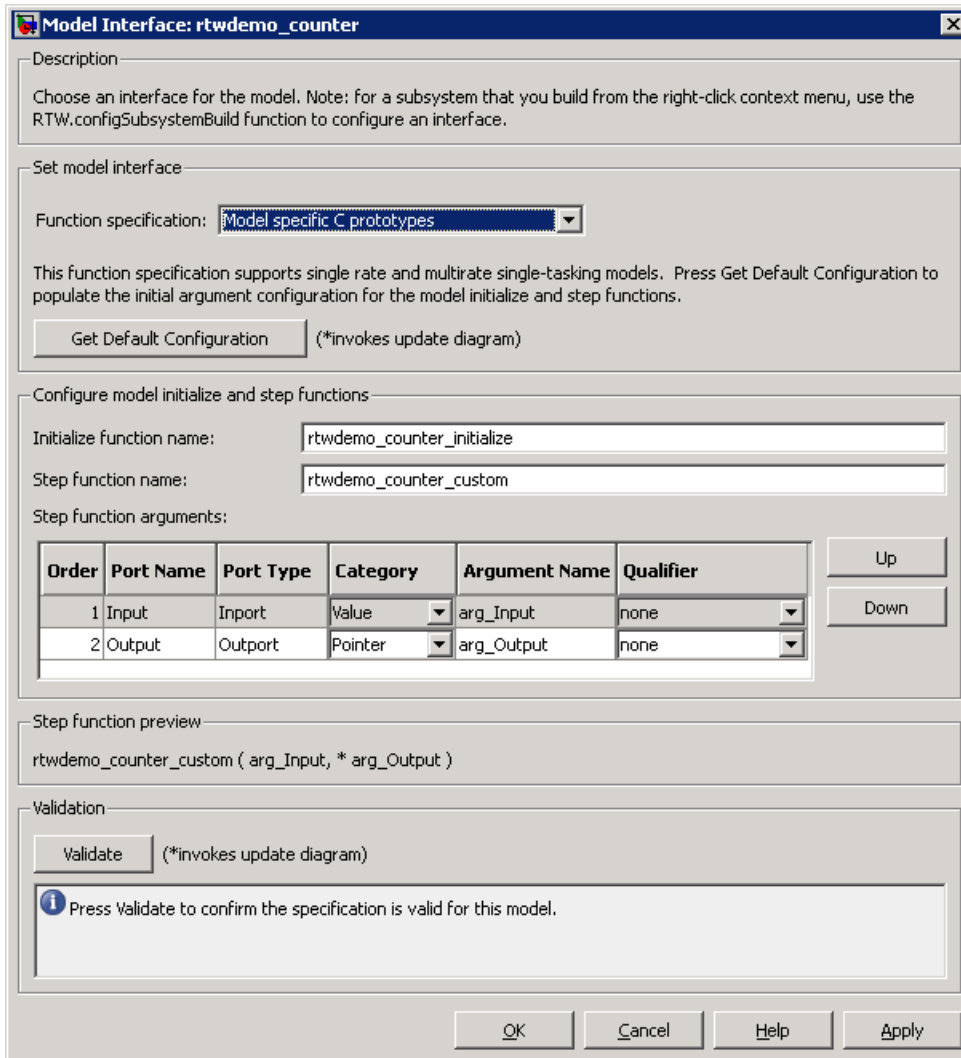

- 10** In the **Configure model initialize and step functions** subpane, change **Initialize function name** to rtdemo_counter_cust_init.
- 11** In the **Configure model initialize and step functions** subpane, in the row for the Input argument, change the value of **Category** from Value to

Pointer and change the value of **Qualifier** from none to const *. The preview reflects your changes.

Model Interface: rtdemo_counter

Description
Choose an interface for the model. Note: for a subsystem that you build from the right-click context menu, use the RTW.configSubsystemBuild function to configure an interface.

Set model interface
Function specification: **Model specific C prototypes**

This function specification supports single rate and multirate single-tasking models. Press Get Default Configuration to populate the initial argument configuration for the model initialize and step functions.

Get Default Configuration (*invokes update diagram)

Configure model initialize and step functions
Initialize function name: rtdemo_counter_cust_init
Step function name: rtdemo_counter_custom
Step function arguments:

Order	Port Name	Port Type	Category	Argument Name	Qualifier
1	Input	Inport	Pointer	arg_Input	const *
2	Output	Outport	Pointer	arg_Output	none

Up
Down

Step function preview
rtdemo_counter_custom (* arg_Input, * arg_Output)

Validation
Validate (*invokes update diagram)

i Press Validate to confirm the specification is valid for this model.

OK Cancel Help Apply

12 Click the **Validate** button to validate the modified function prototype. The **Validation** subpane displays a message that the validation succeeded.

- 13 Click **OK** to exit the Model Interface dialog box.
- 14 Generate code for the model. When the build completes, the code generation report for `rtwdemo_counter` appears.
- 15 In the code generation report, click the link for `rtwdemo_counter.c`.
- 16 Locate and examine the generated code for the `rtwdemo_counter_custom` and `rtwdemo_counter_cust_init` functions:

```
/* Customized model step function */
void rtwdemo_counter_custom(const int32_T *arg_Input, int32_T *arg_Output)
{
    ...
}

/* Model initialize function */
void rtwdemo_counter_cust_init(void)
{
    ...
}
```

- 17 Verify that the generated code is consistent with the function prototype modifications that you specified in the Model Interface dialog box.

Configure Function Prototypes Programmatically

You can use the function prototype control functions (listed in Function Prototype Control Functions on page 12-18), to programmatically control model function prototypes. Typical uses of these functions include:

- **Create and validate a new function prototype**
 - 1 Create a model-specific C function prototype with `obj = RTW.ModelSpecificCPrototype`, where `obj` returns a handle to a newly created, empty function prototype.
 - 2 Add argument configuration information for your model ports using `RTW.ModelSpecificCPrototype.addArgConf`.
 - 3 Attach the function prototype to your loaded ERT-based Simulink model using `RTW.ModelSpecificCPrototype.attachToModel`.

- 4 Validate the function prototype using `RTW.ModelSpecificCPrototype.runValidation`.
- 5 If validation succeeds, save your model and then generate code using the `rtwbuild` function.

- **Modify and validate an existing function prototype**

- 1 Get the handle to an existing model-specific C function prototype that is attached to your loaded ERT-based Simulink model with `obj = RTW.getFunctionSpecification(modelName)`, where `modelName` is a string specifying the name of a loaded ERT-based Simulink model, and `obj` returns a handle to a function prototype attached to the specified model.

You can use other function prototype control functions on the returned handle only if the test `isa(obj, 'RTW.ModelSpecificCPrototype')` returns 1. If the model does not have a function prototype configuration, the function returns []. If the function returns a handle to an object of type `RTW.FcnDefault`, you cannot modify the existing function prototype.

- 2 Use the `Get` and `Set` functions listed in Function Prototype Control Functions on page 12-18 to test and reset such items as the function names, argument names, argument positions, argument categories, and argument type qualifiers.
 - 3 Validate the function prototype using `RTW.ModelSpecificCPrototype.runValidation`.
 - 4 If validation succeeds, save your model and then generate code using the `rtwbuild` function.
- **Create and validate a new function prototype, starting with default configuration information from your Simulink model**
 - 1 Create a model-specific C function prototype using `obj = RTW.ModelSpecificCPrototype`, where `obj` returns a handle to a newly created, empty function prototype.
 - 2 Attach the function prototype to your loaded ERT-based Simulink model using `RTW.ModelSpecificCPrototype.attachToModel`.
 - 3 Get default configuration information from your model using `RTW.ModelSpecificCPrototype.getDefaultConf`.

- 4 Use the `Get` and `Set` functions listed in Function Prototype Control Functions on page 12-18 to test and reset such items as the function names, argument names, argument positions, argument categories, and argument type qualifiers.
 - 5 Validate the function prototype using `RTW.ModelSpecificCPrototype.runValidation`.
 - 6 If validation succeeds, save your model and then generate code using the `rtwbuild` function.
- **Reset the model function prototype to the default ERT function configuration** Create an object of the ERT default function signature. Reset the model function prototype and undo any custom settings, by calling the `RTW.FcnDefault` method, `attachToModel`, as follows:

```
obj = RTW.FcnDefault;
obj.attachToModel(model);
```

`model` must be a loaded ERT-based model.

Note You should not use the same model-specific C function prototype object across multiple models. If you do, changes that you make to the step and initialization function prototypes in one model are propagated to other models, which is usually not desirable.

Function Prototype Control Functions

Function	Description
<code>RTW.ModelSpecificCPrototype.addArgConf</code>	Add step function argument configuration information for Simulink model port to model-specific C function prototype
<code>RTW.ModelSpecificCPrototype.attachToModel</code>	Attach model-specific C function prototype to loaded ERT-based Simulink model
<code>RTW.ModelSpecificCPrototype.getArgCategory</code>	Get step function argument category for Simulink model port from model-specific C function prototype

Function Prototype Control Functions (Continued)

Function	Description
<code>RTW.ModelSpecificCPrototype.getArgName</code>	Get step function argument name for Simulink model port from model-specific C function prototype
<code>RTW.ModelSpecificCPrototype.getArgPosition</code>	Get step function argument position for Simulink model port from model-specific C function prototype
<code>RTW.ModelSpecificCPrototype.getArgQualifier</code>	Get step function argument type qualifier for Simulink model port from model-specific C function prototype
<code>RTW.ModelSpecificCPrototype.getDefaultConf</code>	Get default configuration information for model-specific C function prototype from Simulink model to which it is attached
<code>RTW.ModelSpecificCPrototype.getFunctionName</code>	Get function names from model-specific C function prototype
<code>RTW.ModelSpecificCPrototype.getNumArgs</code>	Get number of step function arguments from model-specific C function prototype
<code>RTW.ModelSpecificCPrototype.getPreview</code>	Get model-specific C function prototype code previews
<code>RTW.configSubsystemBuild</code>	Launch GUI to configure C function prototype or C++ encapsulation interface for right-click build of specified subsystem
<code>RTW.getFunctionSpecification</code>	Get handle to model-specific C function prototype object
<code>RTW.ModelSpecificCPrototype.runValidation</code>	Validate model-specific C function prototype against Simulink model to which it is attached
<code>RTW.ModelSpecificCPrototype.setArgCategory</code>	Set step function argument category for Simulink model port in model-specific C function prototype

Function Prototype Control Functions (Continued)

Function	Description
RTW.ModelSpecificCPrototype.setArgName	Set step function argument name for Simulink model port in model-specific C function prototype
RTW.ModelSpecificCPrototype.setArgPosition	Set step function argument position for Simulink model port in model-specific C function prototype
RTW.ModelSpecificCPrototype.setArgQualifier	Set step function argument type qualifier for Simulink model port in model-specific C function prototype
RTW.ModelSpecificCPrototype.setFunctionName	Set function names in model-specific C function prototype

Sample Script for Configuring Function Prototypes

The following sample MATLAB script configures the model function prototypes for the `rtwdemo_counter` model, using the Function Prototype Control Functions on page 12-18.

```

%% Open the rtwdemo_counter model
rtwdemo_counter

%% Select ert.tlc as the System Target File for the model
set_param(gcs, 'SystemTargetFile', 'ert.tlc')

%% Create a model-specific C function prototype
a=RTW.ModelSpecificCPrototype

%% Add argument configuration information for Input and Output ports
addArgConf(a, 'Input', 'Pointer', 'inputArg', 'const *')
addArgConf(a, 'Output', 'Pointer', 'outputArg', 'none')

%% Attach the model-specific C function prototype to the model
attachToModel(a, gcs)

%% Rename the initialization function

```

```

setFunctionName(a,'InitFunction','init')

%% Rename the step function and change some argument attributes
setFunctionName(a,'StepFunction','step')
setArgPosition(a,'Output',1)
setArgCategory(a,'Input','Value')
setArgName(a,'Input','InputArg')
setArgQualifier(a,'Input','none')

%% Validate the function prototype against the model
[status,message]=runValidation(a)

%% if validation succeeded, generate code and build
if status
    rtwbuild(gcs)
end

```

Verify Generated Code for Customized Functions

You can use software-in-the-loop (SIL) testing to verify the generated code for your customized step and initialization functions. This involves creating a SIL block with your generated code, which then can be integrated into a Simulink model to verify that the generated code provides the same result as the original model or nonvirtual subsystem. For more information, see “Generate S-Function Wrappers” on page 21-2 and “About SIL and PIL Simulations” on page 31-2.

Function Prototype Control Limitations

The following limitations apply to controlling model function prototypes:

- Function prototype control supports only step and initialization functions generated from a Simulink model.
- Function prototype control supports only single-instance implementations. For standalone targets, you must clear the **Generate reusable code** check box (on the **Interface** pane of the Configuration Parameters dialog box). For model reference targets, you must select One for the **Total number of instances allowed per top model** parameter (on the **Model Referencing** pane of the Configuration Parameters dialog box).

- For model reference targets, the code generator ignores the **Generate reusable code** parameter (on the **Interface** pane of the Configuration Parameters dialog box).
- You must select the **Single output/update function** parameter (on the **Interface** pane of the Configuration Parameters dialog box).
- Function prototype control does not support multitasking models. Multirate models are supported, but you must configure the models for single-tasking.
- You must configure root-level inports and outports to use Auto storage classes.
- Do not control function prototypes with the static `ert_main.c` provided by MathWorks. Specifying a function prototype control configuration other than the default creates a mismatch between the generated code and the default static `ert_main.c`.
- The code generator removes the data structure for the root inports of the model unless a subsystem implemented by a nonreusable function uses the value of one or more of the inports.
- The code generator removes the data structure for the root outports of the model except when you enable MAT-file logging, or if the sample time of one or more of the outports is not the fundamental base rate (including a constant rate).
- If you copy a subsystem block and paste it to create a new block in either a new model or the same model, the function prototype control interface information from the original subsystem block does not copy to the new subsystem block.
- If you have a Stateflow license, for a Stateflow chart that uses a model root inport value, or that calls a subsystem that uses a model root inport value, you must do one of the following to generate code:
 - Clear the **Execute (enter) Chart At Initialization** check box in the Stateflow chart.
 - Make the Stateflow function a nonreusable function.
 - Insert a Signal Conversion block immediately after the root inport. On the Signal Conversion block parameters dialog box, select the **Exclude this block from 'Block reduction' optimization** check box in the .

- If a model root inport value connects to a Simscape™ conversion block, you must insert a Simulink Signal Conversion block between the root inport and the Simscape conversion block. On the Simulink Signal Conversion block parameter dialog box, select **Exclude this block from 'Block reduction' optimization**.

C++ Encapsulation Interface Control

In this section...

“About C++ Encapsulation Interface Control” on page 12-24

“Simple Use of C++ Encapsulation Control” on page 12-25

“Configure C++ Encapsulation Interfaces Using Graphical Interfaces” on page 12-33

“Configure C++ Encapsulation Interfaces Programmatically” on page 12-43

“Configure the Step Method for a Model Class” on page 12-46

“C++ Encapsulation Interface Control Limitations” on page 12-47

About C++ Encapsulation Interface Control

Using the **Language** option, C++ (Encapsulated), on the **Code Generation** pane of the Configuration Parameters dialog box, you can generate a C++ class interface to model code. The generated interface encapsulates required model data into C++ class attributes and model entry point functions into C++ class methods. The benefits of encapsulation include:

- Greater control over access to model data
- Ability to multiply instantiate model classes
- Easier integration of model code into C++ programming environments

C++ encapsulation also works for right-click builds of nonvirtual subsystems. (For information on requirements that apply, see “Configure C++ Encapsulation Interfaces for Nonvirtual Subsystems” on page 12-41.)

The general procedure for generating C++ encapsulation interfaces to model code is as follows:

- 1 Configure your model to use an `ert.tlc` system target file provided by MathWorks.
- 2 Select the language option C++ (Encapsulated) for your model.

- 3 Optionally, configure related C++ encapsulation interface settings for your model code, using either a graphical user interface (GUI) or application programming interface (API).
- 4 Generate model code and examine the results.

To get started with an example, see “Simple Use of C++ Encapsulation Control” on page 12-25. For more details about configuring C++ encapsulation interfaces for your model code, see “Configure C++ Encapsulation Interfaces Using Graphical Interfaces” on page 12-33 and “Configure C++ Encapsulation Interfaces Programmatically” on page 12-43. For limitations that apply, see “C++ Encapsulation Interface Control Limitations” on page 12-47.

Note For an example of the C++ encapsulation capability, see the model `rtwdemo_cppencap`.

Simple Use of C++ Encapsulation Control

This example illustrates a simple use of the C++ (Encapsulated) option. It uses C++ encapsulation to generate interfaces for code from an example model, without extensive modifications to default settings.

Note For details about setting C++ encapsulation options, see the sections that follow this example, beginning with “Configure C++ Encapsulation Interfaces Using Graphical Interfaces” on page 12-33.

To generate C++ encapsulated interfaces for a Simulink model:

- 1 Open a model for which you would like to generate C++ encapsulation interfaces. This example uses the model `rtwdemo_counter`.
- 2 Configure the model to use an `ert.tlc` system target file provided by MathWorks. For example, open the Configuration Parameters dialog box, go to the **Code Generation** pane, select a target value from the **System target file** menu, and click **Apply**.

- Optionally, as a baseline for later code comparison, generate code from the model using a different **Language** parameter setting, C++ or C. (You can set up the build directory naming or location to distinguish your baseline build from later builds of the same model.)
- On the **Code Generation** pane of the Configuration Parameters dialog box, select the C++ (Encapsulated) language option.

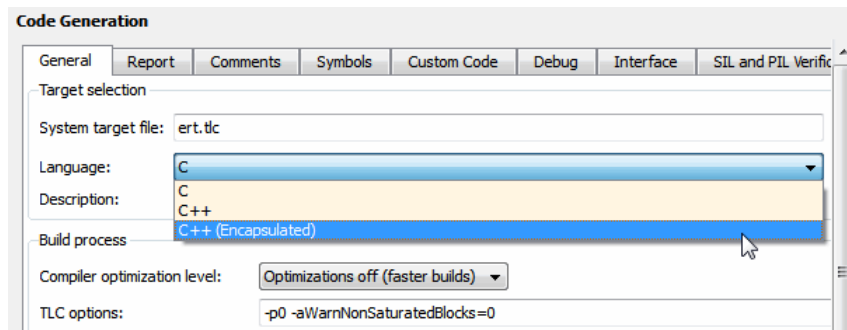

Click **Apply**.

Note To immediately generate the default style of encapsulated C++ code, without exploring the related model configuration options, skip steps 5–9 and go directly to step 10.

- Go to the **Interface** pane of the Configuration Parameters dialog box and examine the **Code interface** subpane.

The screenshot shows a dialog box titled "Code interface". It contains several sections:

- Data Member Visibility/Access Control:** A sub-section with four dropdown menus:
 - Block parameter visibility: private
 - Block parameter access: None
 - Internal data visibility: private
 - Internal data access: None
 - External I/O access: None
- Checkboxes:**
 - Terminate function required
 - Generate destructor
 - Use operator new for referenced model object registration
- Generate preprocessor conditionals:** A dropdown menu set to "Use local settings".
- Additional checkboxes:**
 - Suppress error status in real-time model data structure
 - Combine signal/state structures
- Button:** "Configure C++ Encapsulation Interface"

When you selected the C++ (Encapsulated) language option for your model, C++ encapsulation interface controls replaced the default options on the **Code interface** subpane. See “Configure Code Interface Options” on page 12-34 for descriptions of these controls. You might want to modify the default settings according to your application.

- 6 Click the **Configure C++ Encapsulation Interface** button. This action opens the Configure C++ encapsulation interface dialog box, which allows you to configure the step method for your generated model class. The dialog box initially displays a view for configuring a void-void style step method (passing no I/O arguments) for the model class. In this view, you can rename the model class and the step method for your model.

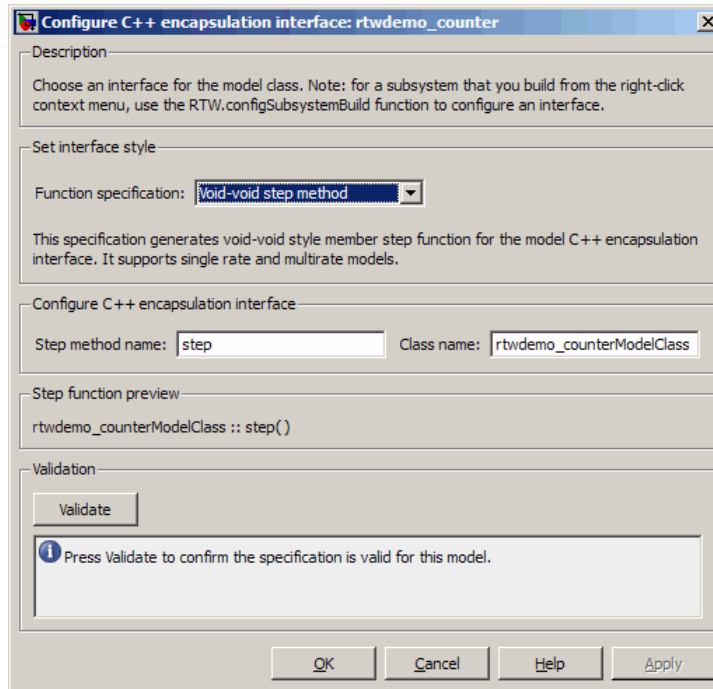

See “Configure Step Method for Your Model Class” on page 12-37 for descriptions of these controls.

Note If the void-void interface style meets your needs, you can skip steps 7–9 and go directly to step 10.

- 7 If you want root-level model input and output to be arguments on the step method, select the value I/O arguments step method from the **Function specification** menu. The dialog box displays a view for configuring an I/O arguments style step method for the model class.

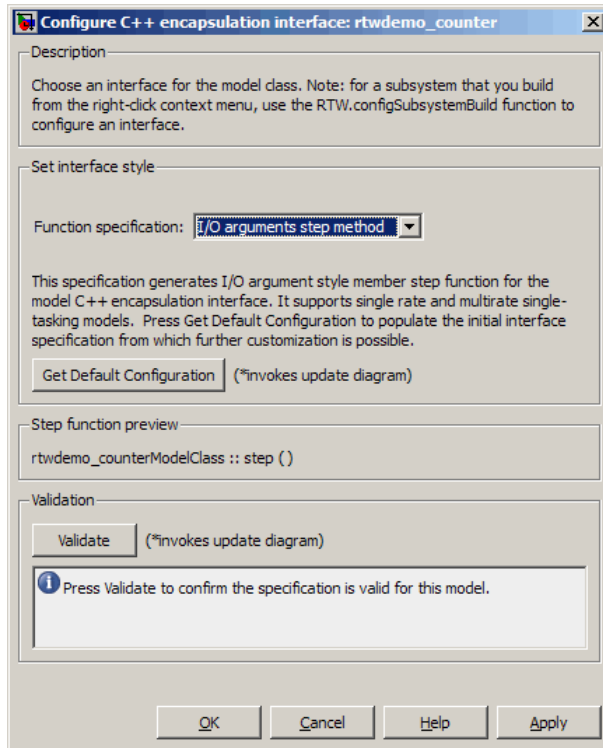

See “Configure Step Method for Your Model Class” on page 12-37 for descriptions of these controls.

- 8 Click the **Get Default Configuration** button. This action causes a **Configure C++ encapsulation interface** subpane to appear in the dialog box. The subpane displays the initial interface configuration for your model, which provides a starting point for further customization.

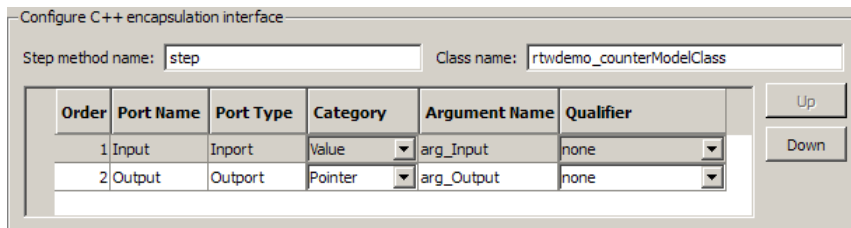

See “Passing I/O Arguments” on page 12-39 for descriptions of these controls.

- 9 Perform this optional step only if you want to customize the configuration of the I/O arguments generated for your model step method.

Note If you choose to skip this step, you should click **Cancel** to exit the dialog box.

If you choose to perform this step, first you must check that the required option **Remove root level I/O zero initialization** is selected on the **Optimization** pane, and then navigate back to the I/O arguments step method view of the Configure C++ encapsulation interface dialog box.

Now you can use the dialog box controls to configure I/O argument attributes. For example, in the **Configure C++ encapsulation interface** subpane, in the row for the Input argument, you can change the value of **Category** from Value to Pointer and change the value of **Qualifier** from none to const *. The preview updates to reflect your changes. Click the **Validate** button to validate the modified interface configuration.

Continue modifying and validating until you are satisfied with the step method configuration.

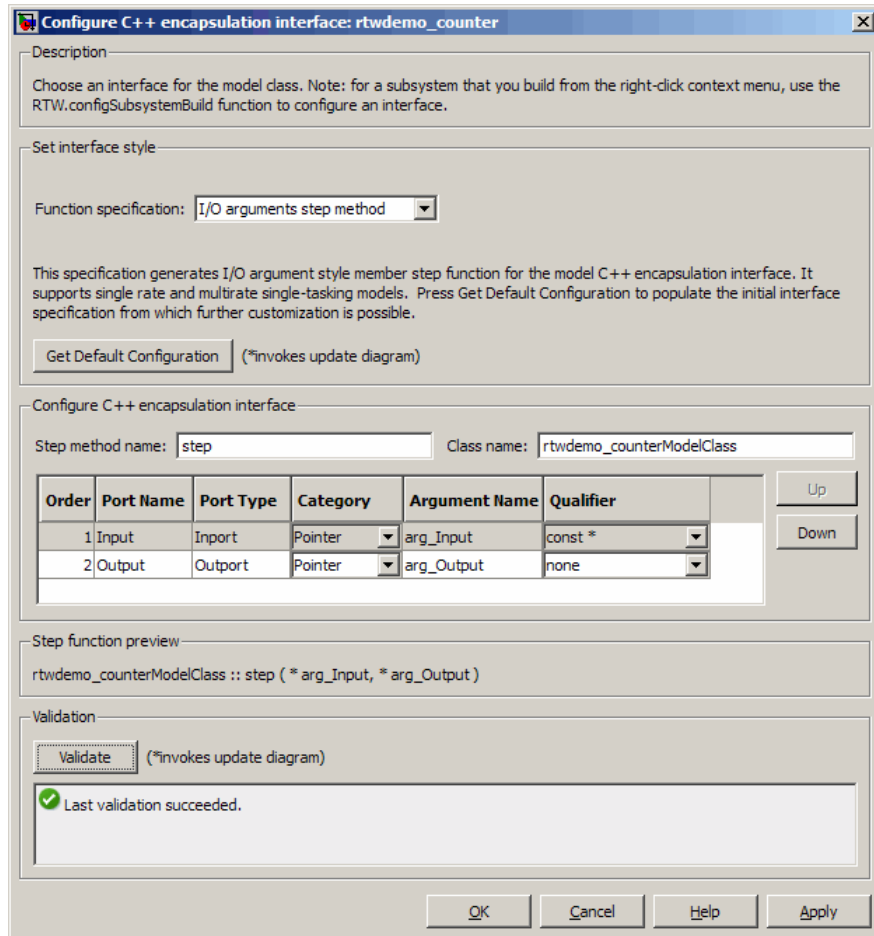

Click **Apply** and **OK**.

- 10 Generate code for the model. When the build completes, the code generation report for `rtwdemo_counter` appears. Examine the report and observe that required model data is encapsulated into C++ class attributes and model entry point functions are encapsulated into C++ class methods. For example, click the link for `rtwdemo_counter.h` to see the class declaration for the model.

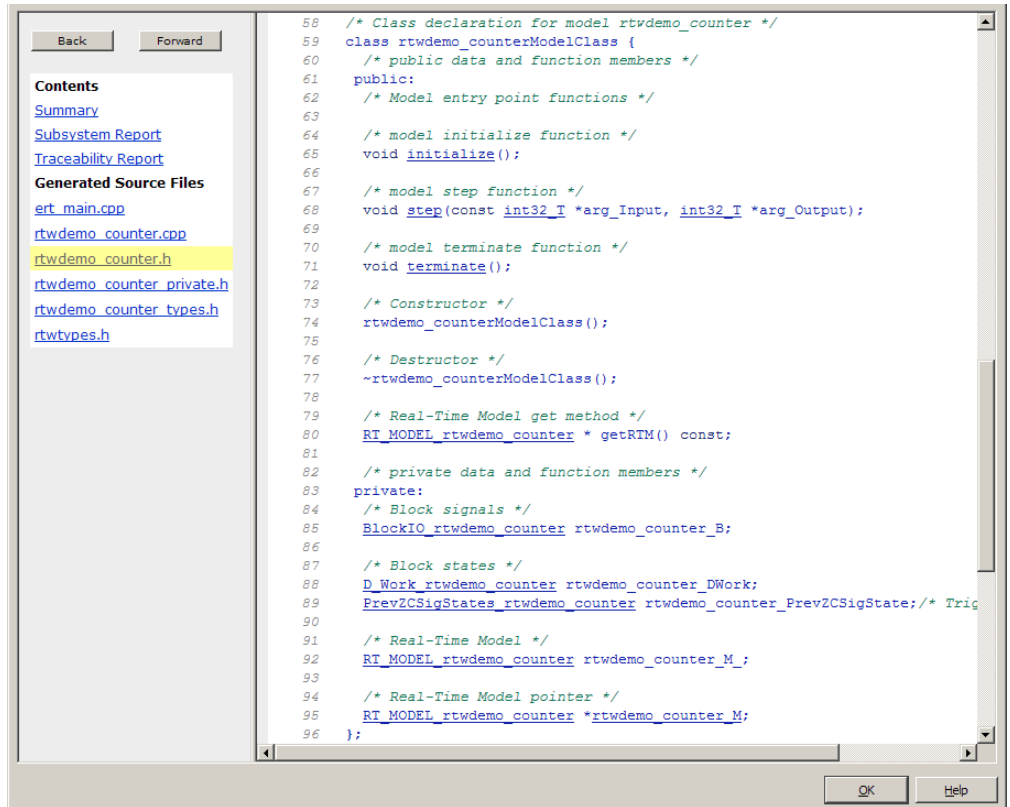

```
58 /* Class declaration for model rtwdemo_counter */
59 class rtwdemo_counterModelClass {
60     /* public data and function members */
61     public:
62     /* Model entry point functions */
63
64     /* model initialize function */
65     void initialize();
66
67     /* model step function */
68     void step(const int32_T *arg_Input, int32_T *arg_Output);
69
70     /* model terminate function */
71     void terminate();
72
73     /* Constructor */
74     rtwdemo_counterModelClass();
75
76     /* Destructor */
77     ~rtwdemo_counterModelClass();
78
79     /* Real-Time Model get method */
80     RT_MODEL_rtwdemo_counter * getRTM() const;
81
82     /* private data and function members */
83     private:
84     /* Block signals */
85     BlockIO_rtwdemo_counter rtwdemo_counter_B;
86
87     /* Block states */
88     D_Work_rtwdemo_counter rtwdemo_counter_DWork;
89     PrevZCSigStates_rtwdemo_counter rtwdemo_counter_PrevZCSigState; /* Trig
90
91     /* Real-Time Model */
92     RT_MODEL_rtwdemo_counter rtwdemo_counter_M;
93
94     /* Real-Time Model pointer */
95     RT_MODEL_rtwdemo_counter *rtwdemo_counter_M;
96     };
```

Note

- If you configured custom I/O arguments for the model step method (optional step 9), examine the generated code for the step method in `rtwdemo_counter.h` and `rtwdemo_counter.cpp`. The arguments should reflect your changes. For example, if you performed the Input argument modifications in step 9, the input argument should appear as `const int32_T *arg_Input`.
- If you saved a baseline model build (optional step 3), you can traverse and compare the generated files in the corresponding build directories.

Configure C++ Encapsulation Interfaces Using Graphical Interfaces

- “Select the C++ (Encapsulated) Option” on page 12-33
- “Configure Code Interface Options” on page 12-34
- “Configure Step Method for Your Model Class” on page 12-37
- “Configure C++ Encapsulation Interfaces for Nonvirtual Subsystems” on page 12-41

Select the C++ (Encapsulated) Option

To select the C++ (Encapsulated) option, in the Configuration Parameters dialog box, on the **Code Generation** pane, use the **Language** menu:

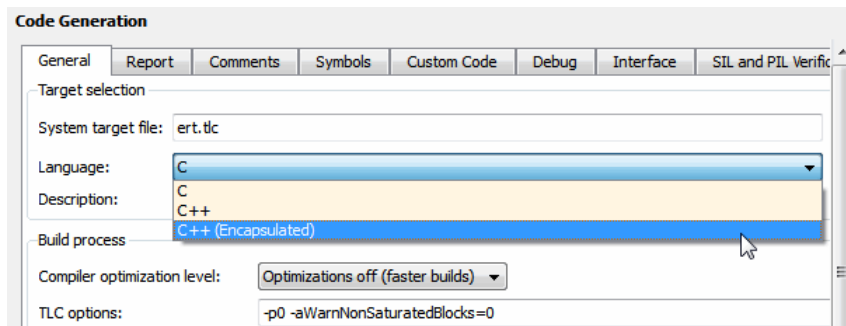

Selecting this option:

- Disables model configuration options that C++ (Encapsulated) does not support. For details, see “C++ Encapsulation Interface Control Limitations” on page 12-47.
- Replaces default options on the **Interface** pane, in the **Code interface** subpane, with C++ encapsulation interface controls, which are described in the next section.

Configure Code Interface Options

When you select the C++ (Encapsulated) option for your model, the C++ encapsulation interface controls shown below replace the **Code interface** default options on the **Interface** pane.

Code interface

Data Member Visibility/Access Control

Block parameter visibility Block parameter access

Internal data visibility Internal data access

External I/O access

Terminate function required Generate destructor Use operator new for referenced model object registration

Generate preprocessor conditionals:

Suppress error status in real-time model data structure Combine signal/state structures

- **Block parameter visibility**

Specifies whether to generate the block parameter structure as a **public**, **private**, or **protected** data member of the C++ model class (**private** by default).

- **Internal data visibility**

Specifies whether to generate internal data structures, such as Block I/O, DWork vectors, Runtime model, Zero-crossings, and continuous states, as **public**, **private**, or **protected** data members of the C++ model class (**private** by default).

- **Block parameter access**

Specifies whether to generate access methods for block parameters for the C++ model class (**None** by default). You can select noninlined access methods (**Method**) or inlined access methods (**Inlined method**).

- **Internal data access**

Specifies whether to generate access methods for internal data structures, such as Block I/O, DWork vectors, Runtime model, Zero-crossings, and continuous states, for the C++ model class (**None** by default). You can select

noninlined access methods (Method) or inlined access methods (Inlined method).

- **External I/O access**

Specifies whether to generate access methods for root-level I/O signals for the C++ model class (None by default). If you want to generate access methods, you have the following options:

- Generate either noninlined or inlined access methods.
- Generate either *per-signal* or *structure-based* access methods. That is, you can generate a series of set and get methods on a per-signal basis, or generate just one set method that takes the address of an external input structure as an argument and, for external outputs (if applicable), just one get method that returns a reference to an external output structure. The generated code for structure-based access methods has the following general form:

```
class ModelClass {
...
    /* Root inports set method*/
    void setExternalInputs(const ExternalInputs* pExternalInputs);
    /* Root outputs get method*/
    const ExternalOutputs & getExternalOutputs() const;
}
```

Note This parameter affects generated code only if you are using the default (void-void style) step method for your model class; *not* if you are explicitly passing arguments for root-level I/O signals using an I/O arguments style step method. For more information, see “Passing No Arguments (void-void)” on page 12-37 and “Passing I/O Arguments” on page 12-39.

- **Terminate function**

Specifies whether to generate the `model_terminate` function (on by default). This function contains model termination code and should be called as part of system shutdown.

- **Generate destructor**

Specifies whether to generate a destructor for the C++ model class (on by default).

- **Use operator new for referenced model object registration**

For a model containing Model blocks, specifies whether generated code should use dynamic memory allocation, during model object registration, to instantiate objects for referenced models configured with a C++ encapsulation interface (off by default). If you select this option, during instantiation of an object for the top model in a model reference hierarchy, the generated code uses the operator `new` to instantiate objects for referenced models.

Selecting this option frees a parent model from having to maintain information about submodels beyond its direct children. Clearing this option means that a parent model maintains information about its submodels, including its direct and indirect children.

Note If you select this option, be aware that a `bad_alloc` exception might be thrown, per the C++ standard, if an out-of-memory error occurs during the use of `new`. You must provide code to catch and process the `bad_alloc` exception in case an out-of-memory error occurs for a `new` call during construction of a top model object.

- **Generate preprocessor conditionals**

For a model containing Model blocks, specifies whether to generate preprocessor conditional directives globally for a model, locally for each variant Model block, or conditionally based on the **Generate preprocessor conditionals** setting in the Model Reference Parameter dialog for each variant Model block (Use `local settings` by default).

- **Suppress error status in real-time model data structure**

Specifies whether to omit the error status field from the generated real-time model data structure `rtModel` (off by default). Selecting this option reduces memory usage.

Be aware that selecting this option can cause the code generator to omit the `rtModel` data structure from generated code.

- **Combine signal/state structures**

Specifies whether to combine global block signals and global state data into one data structure in the generated code (off by default). Selecting this option reduces RAM and improves readability of the generated code.

- **Configure C++ Encapsulation Interface**

Opens the Configure C++ encapsulation interface dialog box, which allows you to configure the step method for your model class. For more information, see “Configure Step Method for Your Model Class” on page 12-37.

Configure Step Method for Your Model Class

To configure the step method for your model class, on the **Interface** pane, click the **Configure C++ Encapsulation Interface** button, which is available when you select C++ (Encapsulated) for your model. This action opens the Configure C++ encapsulation interface dialog box, where you can configure the step method for your model class in either of two styles:

- “Passing No Arguments (void-void)” on page 12-37
- “Passing I/O Arguments” on page 12-39

Note The void-void style of step method specification supports single-rate models and multirate models, while the I/O arguments style supports single-rate models and multirate single-tasking models.

Passing No Arguments (void-void). The Configure C++ encapsulation interface dialog box initially displays a view for configuring a void-void style step method for the model class.

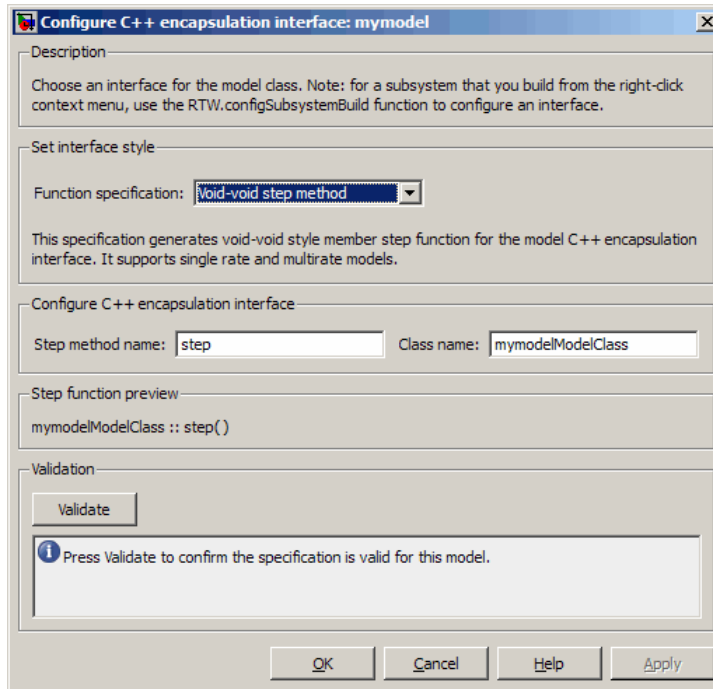

- **Step method name**
Allows you to specify a step method name other than the default, `step`.
- **Class name**
Allows you to specify a model class name other than the default, `modelModelClass`.
- **Step function preview**
Displays a preview of the model step function prototype as currently configured. The preview display is dynamically updated as you make configuration changes.
- **Validate**
Validates your current model step function configuration. The **Validation** pane displays the status and an explanation of any failure.

Passing I/O Arguments. If you select I/O arguments step method from the **Function specification** menu, the dialog box displays a view for configuring an I/O arguments style step method for the model class.

Note To use the I/O arguments style step method, you must select the option **Remove root level I/O zero initialization** on the **Optimization** pane of the Configuration Parameters dialog box.

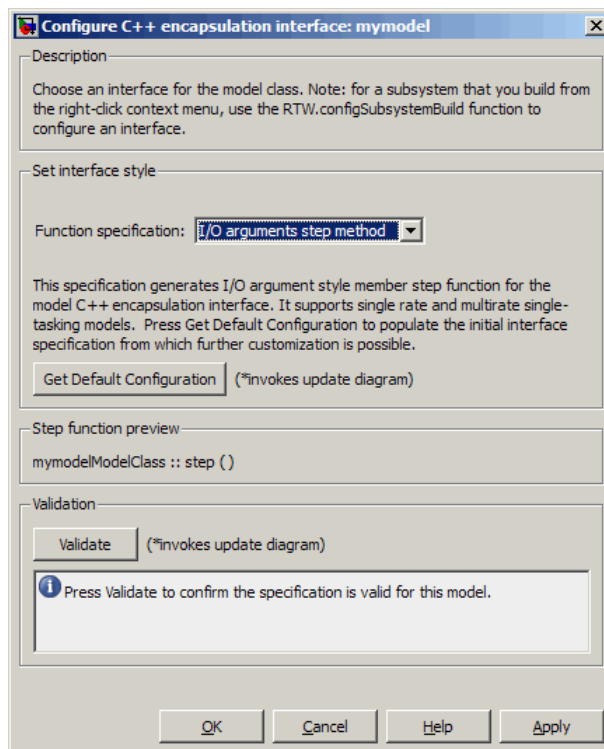

- **Get Default Configuration**

Click this button to get the initial interface configuration that provides a starting point for further customization.

- **Step function preview**

Displays a preview of the model step function prototype as currently configured. The preview dynamically updates as you make configuration changes.

- **Validate**

Validates your current model step function configuration. The **Validation** pane displays the status and an explanation of any failure.

When you click **Get Default Configuration**, the **Configure C++ encapsulation interface** subpane appears in the dialog box, displaying the initial interface configuration. For example:

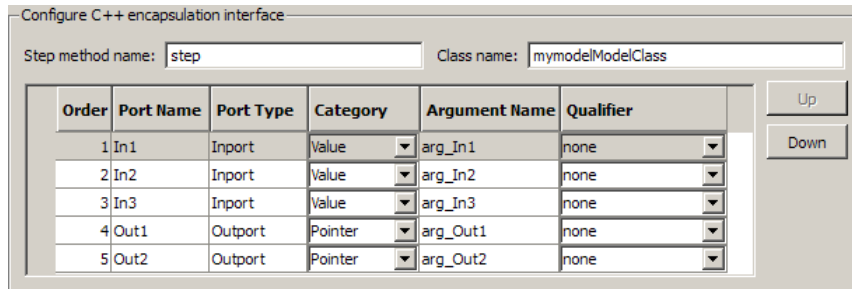

- **Step method name**

Allows you to specify a step method name other than the default, `step`.

- **Class name**

Allows you to specify a model class name other than the default, `modelModelClass`.

- **Order**

Displays the numerical position of each argument. Use the **Up** and **Down** buttons to change argument order.

- **Port Name**

Displays the port name of each argument (not configurable using this dialog box).

- **Port Type**

Displays the port type, Inport or Outport, of each argument (not configurable using this dialog box).

- **Category**

Displays the passing mechanism for each argument. To change the passing mechanism for an argument, select Value, Pointer, or Reference from the argument's **Category** menu.

- **Argument Name**

Displays the name of each argument. To change an argument name, click in the argument's **Argument name** field, position the cursor for text entry, and enter the new name.

- **Qualifier**

Displays the const type qualifier for each argument. To change the qualifier for an argument, select an available value from the argument's **Qualifier** menu. The possible values are:

- none
- const (value)
- const* (value referenced by the pointer)
- const*const (value referenced by the pointer and the pointer itself)
- const & (value referenced by the reference)

Tip When a model includes a referenced model, the `const` type qualifier for the root input argument of the referenced model's specified step function interface is set to `none` and the qualifier for the source signal in the referenced model's parent is set to a value other than `none`, code generation honors the referenced model's interface specification by generating a type cast that discards the `const` type qualifier from the source signal. To override this behavior, add a `const` type qualifier to the referenced model.

Configure C++ Encapsulation Interfaces for Nonvirtual Subsystems

C++ encapsulation interfaces can be configured for right-click builds of nonvirtual subsystems in Simulink models, provided that:

- You select the system target file `ert.tlc` for the model.
- You select the **Language** parameter value **C++ (Encapsulated)** for the model.
- The subsystem is convertible to a Model block using the function `Simulink.SubSystem.convertToModelReference`. For referenced model conversion requirements, see the Simulink reference page `Simulink.SubSystem.convertToModelReference`.

To configure C++ encapsulation interfaces for a subsystem that meets the requirements:

- 1** Open the containing model and select the subsystem block.
- 2** Enter the following MATLAB command:

```
RTW.configSubsystemBuild(gcb)
```

where `gcb` is the Simulink function `gcb`, returning the full block path name of the current block.

This command opens a subsystem equivalent of the Configure C++ encapsulation interface dialog sequence that is described in detail in the preceding section, “Configure Step Method for Your Model Class” on page 12-37. (For more information about using the MATLAB command, see `RTW.configSubsystemBuild`.)

- 3** Use the Configure C++ encapsulation interface dialog boxes to configure C++ encapsulation settings for the subsystem.
- 4** Right-click the subsystem and select **C/C++ Code > Build This Subsystem**.
- 5** When the subsystem build completes, you can examine the C++ encapsulation interfaces in the generated files and the HTML code generation report.

Configure C++ Encapsulation Interfaces Programmatically

If you select the **Language** option C++ (Encapsulated) for your model, you can use the C++ encapsulation interface control functions (listed in C++ Encapsulation Interface Control Functions on page 12-44) to programmatically configure the step method for your model class.

Typical uses of these functions include:

- **Create and validate a new step method interface, starting with default configuration information from your Simulink model**
 - 1 Create a model-specific C++ encapsulation interface with *obj* = `RTW.ModelCPPVoidClass` or *obj* = `RTW.ModelCPPArgsClass`, where *obj* returns a handle to an newly created, empty C++ encapsulation interface.
 - 2 Attach the C++ encapsulation interface to your loaded ERT-based Simulink model using `attachToModel`.
 - 3 Get default C++ encapsulation interface configuration information from your model using `getDefaultConf`.
 - 4 Use the `Get` and `Set` functions listed in C++ Encapsulation Interface Control Functions on page 12-44 to test or reset the model class name and model step method name. Additionally, if you are using the I/O arguments style step method, you can test and reset argument names, argument positions, argument categories, and argument type qualifiers.
 - 5 Validate the C++ encapsulation interface using `runValidation`. (If validation fails, use the error message information that `runValidation` returns to address the issues.)
 - 6 Save your model and then generate code using the `rtwbuild` function.
- **Modify and validate an existing step method interface for a Simulink model**
 - 1 Get the handle to an existing model-specific C++ encapsulation interface that is attached to your loaded ERT-based Simulink model using *obj* = `RTW.getEncapsulationInterfaceSpecification(modelName)`, where *modelName* is a string specifying the name of a loaded ERT-based Simulink model, and *obj* returns a handle to a C++ encapsulation

interface attached to the specified model. If the model does not have an attached C++ encapsulation interface configuration, the function returns [].

- 2 Use the **Get** and **Set** functions listed in C++ Encapsulation Interface Control Functions on page 12-44 to test or reset the model class name and model step method name. Additionally, if the returned interface uses the I/O arguments style step method, you can test and reset argument names, argument positions, argument categories, and argument type qualifiers.
- 3 Validate the C++ encapsulation interface using `runValidation`. (If validation fails, use the error message information that `runValidation` returns to address the issues.)
- 4 Save your model and then generate code using the `rtwbuild` function.

Note You should not use the same model-specific C++ encapsulation interface control object across multiple models. If you do, changes that you make to the step method configuration in one model propagate to other models, which is usually not desirable.

C++ Encapsulation Interface Control Functions

Function	Description
<code>attachToModel</code>	Attach model-specific C++ encapsulation interface to loaded ERT-based Simulink model
<code>getArgCategory</code>	Get argument category for Simulink model port from model-specific C++ encapsulation interface
<code>getArgName</code>	Get argument name for Simulink model port from model-specific C++ encapsulation interface
<code>getArgPosition</code>	Get argument position for Simulink model port from model-specific C++ encapsulation interface
<code>getArgQualifier</code>	Get argument type qualifier for Simulink model port from model-specific C++ encapsulation interface

C++ Encapsulation Interface Control Functions (Continued)

Function	Description
getClassName	Get class name from model-specific C++ encapsulation interface
getDefaultConf	Get default configuration information for model-specific C++ encapsulation interface from Simulink model to which it is attached
getNumArgs	Get number of step method arguments from model-specific C++ encapsulation interface
getStepMethodName	Get step method name from model-specific C++ encapsulation interface
RTW.configSubsystemBuild	Open GUI to configure C function prototype or C++ encapsulation interface for right-click build of specified subsystem
RTW.getEncapsulation-InterfaceSpecification	Get handle to model-specific C++ encapsulation interface control object
runValidation	Validate model-specific C++ encapsulation interface against Simulink model to which it is attached
setArgCategory	Set argument category for Simulink model port in model-specific C++ encapsulation interface
setArgName	Set argument name for Simulink model port in model-specific C++ encapsulation interface
setArgPosition	Set argument position for Simulink model port in model-specific C++ encapsulation interface
setArgQualifier	Set argument type qualifier for Simulink model port in model-specific C++ encapsulation interface
setClassName	Set class name in model-specific C++ encapsulation interface
setStepMethodName	Set step method name in model-specific C++ encapsulation interface

Configure the Step Method for a Model Class

The following sample MATLAB script configures the step method for the `rtwdemo_counter` model class, using the C++ Encapsulation Interface Control Functions on page 12-44.

```
% Open the rtwdemo_counter model
rtwdemo_counter

% Select ert.tlc as the System Target File for the model
set_param(gcs,'SystemTargetFile','ert.tlc')

% Select C++ (Encapsulated) as the target language for the model
set_param(gcs,'TargetLang','C++ (Encapsulated)')

% Set required option for I/O arguments style step method (cmd off = GUI on)
set_param(gcs,'ZeroExternalMemoryAtStartup','off')

% Create a C++ encapsulated interface using an I/O arguments style step method
a=RTW.ModelCPPArgsClass

% Attach the C++ encapsulated interface to the model
attachToModel(a,gcs)

% Get the default C++ encapsulation interface configuration from the model
getDefaultConf(a)

% Move the Output port argument from position 2 to position 1
setArgPosition(a,'Output',1)

% Reset the model step method name from step to StepMethod
setStepMethodName(a,'StepMethod')

% Change the Input port argument name, category, and qualifier
setArgName(a,'Input','inputArg')
setArgCategory(a,'Input','Pointer')
setArgQualifier(a,'Input','const *')

% Validate the function prototype against the model
[status,message]=runValidation(a)
```



```

%% if validation succeeded, generate code and build
if status
    rtwbuild(gcs)
end

```

C++ Encapsulation Interface Control Limitations

- The C++ (Encapsulated) option does not support some Simulink model configuration options. Selecting C++ (Encapsulated) disables the following items in the Configuration Parameters dialog box:
 - **Identifier format control** subpane on the **Symbols** pane
 - **Templates** pane
 - The **Templates** pane parameter **File customization template** is not supported for C++ (Encapsulated) code generation.
 - Selecting C++ (Encapsulated) turns on the **Templates** pane option **Generate an example main program** but removes it from the Configuration Parameters dialog box. If desired, you can disable it using the command line parameter `GenerateSampleERTMain`.
 - **Code Placement** pane
 - **Memory Sections** pane

Note Selecting C++ (Encapsulated) forces on the **Code Generation** pane model option **Ignore custom storage classes**. By design, C++ (Encapsulated) code generation treats data objects with custom storage classes as if their storage class attribute is set to `Auto`.

- Among the data exchange interfaces available on the **Interface** pane of the Configuration Parameters dialog box, only the **C API** interface is supported for C++ (Encapsulated) code generation. If you select `External mode` or `ASAP2`, code generation fails with a validation error.
- The I/O arguments style of step method specification supports single-rate models and multirate single-tasking models, but not multirate multitasking models.

- The **Code Generation > Export Functions** capability does not support C++ (Encapsulated) as the target language.
- If you have a Stateflow license, for a Stateflow chart that resides in a root model configured to use the I/O arguments step method function specification, and that uses a model root inport value or calls a subsystem that uses a model root inport value, you must do one of the following to generate code:
 - Clear the **Execute (enter) Chart At Initialization** check box in the Stateflow chart.
 - Insert a Signal Conversion block immediately after the root inport. On the Simulink Signal Conversion block parameter dialog box, select **Exclude this block from 'Block reduction' optimization**.
- If a model root inport value connects to a Simscape conversion block, you must insert a Simulink Signal Conversion block between the root inport and the Simscape conversion block. On the Simulink Signal Conversion block parameter dialog box, select **Exclude this block from 'Block reduction' optimization**.
- When building a referenced model that is configured to generate a C++ encapsulation interface:
 - You must use the I/O arguments step method style of the C++ encapsulated interface. The void-void step method style is not supported for referenced models.
 - You cannot use a C++ encapsulation interface in cases when a referenced model cannot have a combined output/update function. Cases include a model that
 - Has multiple sample times
 - Has a continuous sample time
 - Saves states

Atomic Subsystem Code

In this section...

“About Nonvirtual Subsystem Code Generation” on page 12-49

“Configure Subsystem for Generating Modular Function Code” on page 12-50

“Modular Function Code for Nonvirtual Subsystems” on page 12-55

“Nonvirtual Subsystem Modular Function Code Limitations” on page 12-60

About Nonvirtual Subsystem Code Generation

The Embedded Coder software provides a Subsystem Parameters dialog box option, **Function with separate data**, that allows you to generate modular function code for nonvirtual subsystems, including atomic subsystems and conditionally executed subsystems.

By default, the generated code for a nonvirtual subsystem does not separate a subsystem’s internal data from the data of its parent Simulink model. This can make it difficult to trace and test the code, particularly for nonreusable subsystems. Also, in large models containing nonvirtual subsystems, data structures can become large and potentially difficult to compile.

Function with separate data allows you to generate subsystem function code in which the internal data for a nonvirtual subsystem is separated from its parent model and is owned by the subsystem. The subsystem data structure is declared independently from the parent model data structures. A subsystem with separate data has its own block I/O and DWork data structure. As a result, the generated code for the subsystem is easier to trace and test. The data separation also tends to reduce the maximum size of global data structures throughout the model, because they are split into multiple data structures.

To use the **Function with separate data** parameter,

- Your model must use an ERT-based system target file (requires a Embedded Coder license).

- Your subsystem must be configured to be atomic or conditionally executed. For more information, see “Systems and Subsystems”.
- Your subsystem must use the `Nonreusable` function setting for the **Code Generation > Function packaging**.

To configure your subsystem for generating modular function code, you invoke the Subsystem Parameters dialog box and make a series of selections to display and enable the **Function with separate data** option. See “Configure Subsystem for Generating Modular Function Code” on page 12-50 and “Modular Function Code for Nonvirtual Subsystems” on page 12-55 for details. For limitations that apply, see “Nonvirtual Subsystem Modular Function Code Limitations” on page 12-60.

For more information about generating code for atomic subsystems, see the sections “Code Generation of Subsystems” and “Generate Code and Executables for Individual Subsystem” in the Simulink Coder documentation.

Configure Subsystem for Generating Modular Function Code

This section summarizes the steps to configure a nonvirtual subsystem in a Simulink model for modular function code generation.

- 1 Verify that the Simulink model containing the subsystem uses an ERT-based system target file (see the **System target file** parameter on the **Code Generation** pane of the Configuration Parameters dialog box).
- 2 In your Simulink model, select the subsystem for which you want to generate modular function code and launch the Subsystem Parameters dialog box (for example, right-click the subsystem and select **Block Parameters (Subsystem)**). The dialog box for an atomic subsystem is shown below. (In the dialog box for a conditionally executed subsystem, the dialog box option **Treat as atomic unit** is greyed out, and you can skip Step 3.)

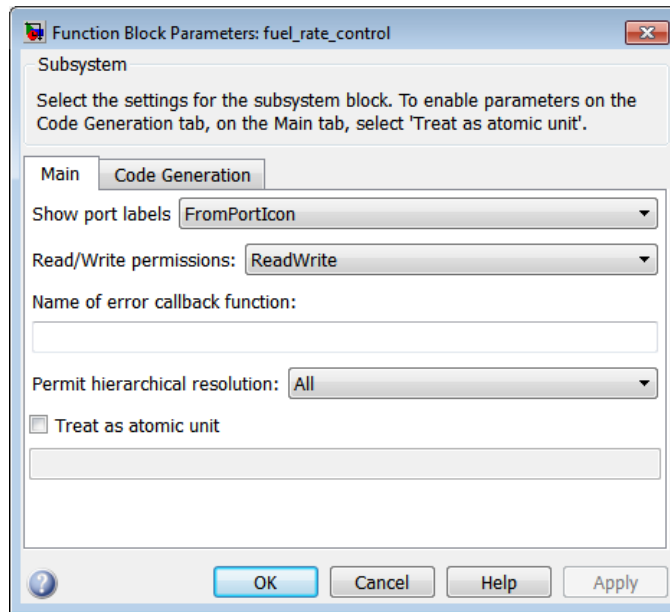

- 3 If the Subsystem Parameters dialog box option **Treat as atomic unit** is available for selection but not selected, the subsystem is neither atomic nor conditionally executed. Select the option **Treat as atomic unit**, which enables **Function packaging** on the **Code Generation** tab. Select the **Code Generation** tab.

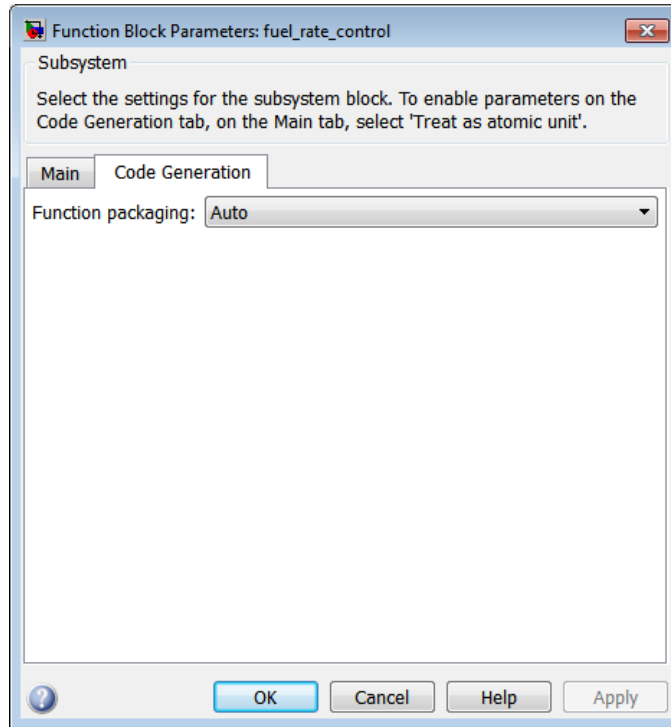

- 4 For the **Function packaging** parameter, select the value **Nonreusable function**. After you make this selection, the **Function with separate data** option is displayed.

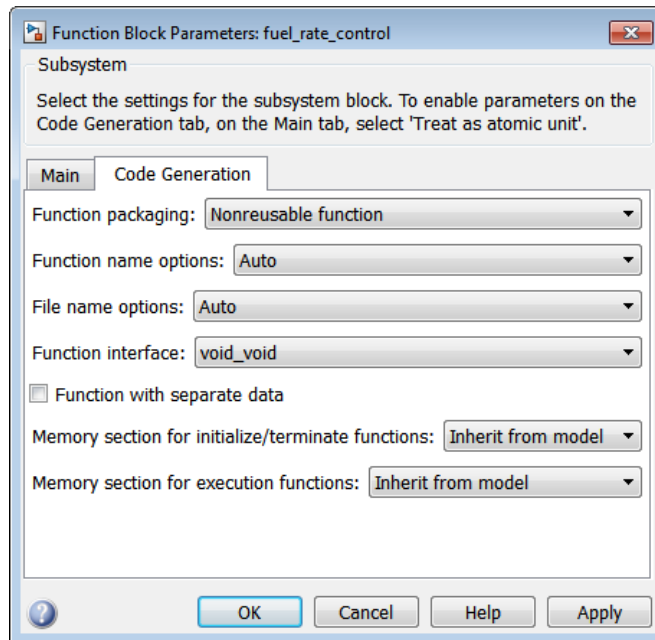

Note Before you generate nonvirtual subsystem function code with the **Function with separate data** option selected, you might want to generate function code with the option *deselected* and save the generated function .c and .h files in a separate directory for later comparison.

- 5 Select the **Function with separate data** option. After you make this selection, additional configuration parameters are displayed.

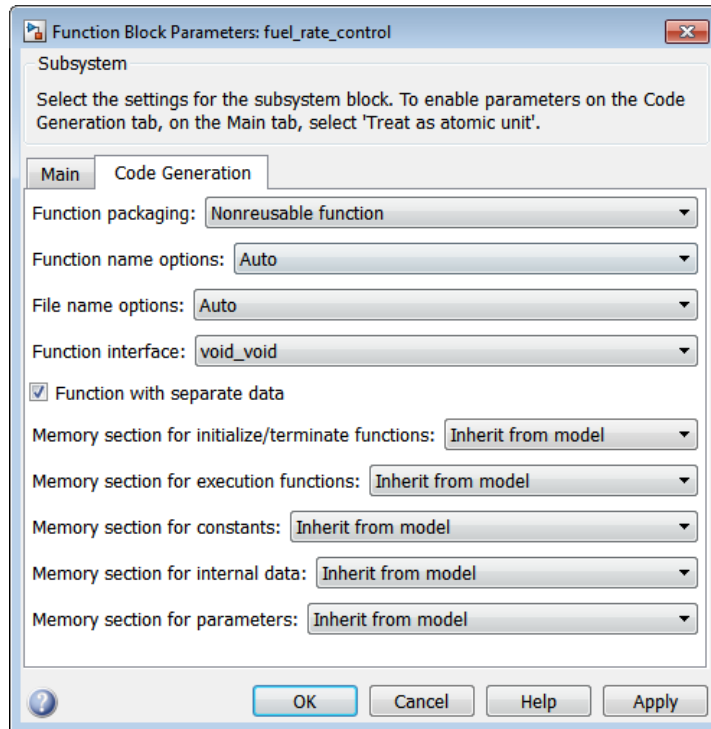

Note To control the naming of the subsystem function and the subsystem files in the generated code, you can modify the subsystem parameters **Function name options** and **File name options**.

- 6 To save your subsystem parameter settings and exit the dialog box, click **OK**.

This completes the subsystem configuration for generating modular function code. You can now generate the code for the subsystem and examine the generated files, including the function `.c` and `.h` files named according to your subsystem parameter specifications. For more information on generating

code for nonvirtual subsystems, see “Code Generation of Subsystems”. For examples of generated subsystem function code, see “Modular Function Code for Nonvirtual Subsystems” on page 12-55.

Modular Function Code for Nonvirtual Subsystems

To illustrate the selection of the **Function with separate data** option for a nonvirtual subsystem, the following procedure generates atomic subsystem function code with and without the option selected and compares the results.

- 1 Open MATLAB and launch the model `rtwdemo_atomic` using the MATLAB command `rtwdemo_atomic`. Examine the Simulink model.

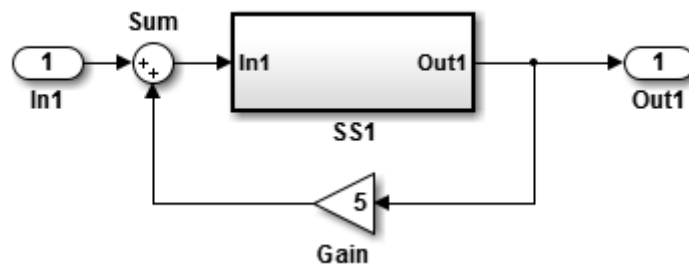

- 2 Double-click the SS1 subsystem and examine the contents. (You can close the subsystem window when you are finished.)

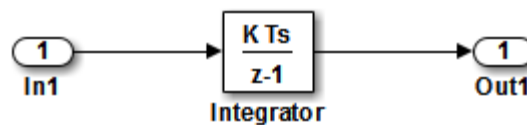

- 3 Use the Configuration Parameters dialog box to change the model's **System target file** from GRT to ERT. For example, from the Simulink window, select **Simulation > Model Configuration Parameters**. On the Configuration Parameters dialog box, select the **Code Generation** pane and specify `ert.tlc` for the **System target file** parameter. Click **OK** twice to confirm the change.

- 4 Create a variant of `rtwdemo_atomic` that illustrates function code *without* data separation.
 - a In the Simulink view of `rtwdemo_atomic`, right-click the SS1 subsystem and select **Block Parameters (Subsystem)**. In the Subsystem Parameters dialog box, verify that
 - On the **Main** tab, **Treat as atomic unit** is selected
 - On the **Code Generation** tab, `User specified` is selected for **Function name options**
 - On the **Code Generation** tab, `myfun` is specified for **Function name**
 - b In the Subsystem Parameters dialog box, on the **Code Generation** tab
 - i Select the value `Nonreusable function` for the **Function packaging** parameter. After this selection, additional parameters and options will appear.
 - ii Select the value `Use function name` for the **File name options** parameter. This selection is optional but simplifies the later task of code comparison by causing the atomic subsystem function code to be generated into the files `myfun.c` and `myfun.h`.

Do *not* select the option **Function with separate data**. Click **Apply** to apply the changes and click **OK** to exit the dialog box.

 - c Save this model variant to a personal work directory, for example, `rtwdemo_atomic1` in `d:/atomic`.
- 5 Create a variant of `rtwdemo_atomic` that illustrates function code *with* data separation.
 - a In the Simulink view of `rtwdemo_atomic1` (or `rtwdemo_atomic` with step 3 reapplied), right-click the SS1 subsystem and select **Block Parameters (Subsystem)**. In the Subsystem Parameters dialog box, verify that
 - On the **Main** tab, **Treat as atomic unit** is selected
 - On the **Code Generation** tab, `Function` is selected for **Function packaging**
 - On the **Code Generation** tab, `User specified` is selected for **Function name options**

- On the **Code Generation** tab, myfun is specified for **Function name**
 - On the **Code Generation** tab, Use function name is specified for **File name options**
- b** In the Subsystem Parameters dialog box, on the **Code Generation** tab, select the option **Function with separate data**. Click **Apply** to apply the change and click **OK** to exit the dialog box.
 - c** Save this model variant, using a different name than the first variant, to a personal work directory, for example, rtwdemo_atomic2 in d:/atomic.
- 6** Generate code for each model, rtwdemo_atomic1 and rtwdemo_atomic2.
 - 7** In the generated code directories, compare the *model.c/.h* and *myfun.c/.h* files generated for the two models. (In this example, there are not significant differences in the generated variants of *ert_main.c*, *model_private.h*, *model_types.h*, or *rtwtypes.h*.)

H File Differences for Nonvirtual Subsystem Function Data Separation

The differences between the H files generated for rtwdemo_atomic1 and rtwdemo_atomic2 help illustrate the selection of the **Function with separate data** option for nonvirtual subsystems.

- 1** Selecting **Function with separate data** causes typedefs for subsystem data to be generated in the *myfun.h* file for rtwdemo_atomic2:

```
/* Block signals for system '<Root>/SS1' */
typedef struct {
    real_T Integrator;           /* '<S1>/Integrator' */
} rtB_myfun;

/* Block states (auto storage) for system '<Root>/SS1' */
typedef struct {
    real_T Integrator_DSTATE;   /* '<S1>/Integrator' */
} rtDW_myfun;
```

By contrast, for rtwdemo_atomic1, typedefs for subsystem data belong to the model and appear in *rtwdemo_atomic1.h*:

```
/* Block signals (auto storage) */
```

```

typedef struct {
    ...
    real_T Integrator;                /* '<S1>/Integrator' */
} BlockIO_rtwdemo_atomic1;

/* Block states (auto storage) for system '<Root>' */
typedef struct {
    real_T Integrator_DSTATE;        /* '<S1>/Integrator' */
} D_Work_rtwdemo_atomic1;

```

- 2** Selecting **Function with separate data** generates the following external declarations in the `myfun.h` file for `rtwdemo_atomic2`:

```

/* Extern declarations of internal data for 'system '<Root>/SS1'' */
extern rtB_myfun_rtwdemo_atomic2_myfunB;

extern rtDW_myfun_rtwdemo_atomic2_myfunDW;

extern void myfun_initialize(void);

```

By contrast, the generated code for `rtwdemo_atomic1` contains model-level external declarations for the subsystem's `BlockIO` and `D_Work` data, in `rtwdemo_atomic1.h`:

```

/* Block signals (auto storage) */
extern BlockIO_rtwdemo_atomic1_rtwdemo_atomic1_B;

/* Block states (auto storage) */
extern D_Work_rtwdemo_atomic1_rtwdemo_atomic1_DWork;

```

C File Differences for Nonvirtual Subsystem Function Data Separation

The differences between the C files generated for `rtwdemo_atomic1` and `rtwdemo_atomic2` illustrate the selection of the **Function with separate data** option for nonvirtual subsystems.

- 1** Selecting **Function with separate data** causes a separate subsystem initialize function, `myfun_initialize`, to be generated in the `myfun.c` file for `rtwdemo_atomic2`:

```
void myfun_initialize(void) {
    {
        ((real_T*)&rtwdemo_atomic2_myfunB.Integrator)[0] = 0.0;
    }
    rtwdemo_atomic2_myfunDW.Integrator_DSTATE = 0.0;
}
```

The subsystem initialize function in `myfun.c` is invoked by the model initialize function in `rtwdemo_atomic2.c`:

```
/* Model initialize function */

void rtwdemo_atomic2_initialize(void)
{
    ...

    /* Initialize subsystem data */
    myfun_initialize();
}
```

By contrast, for `rtwdemo_atomic1`, subsystem data is initialized by the model initialize function in `rtwdemo_atomic1.c`:

```
/* Model initialize function */

void rtwdemo_atomic1_initialize(void)
{
    ...
    /* block I/O */
    {
        ...
        ((real_T*)&rtwdemo_atomic1_B.Integrator)[0] = 0.0;
    }

    /* states (dwork) */

    rtwdemo_atomic1_DWork.Integrator_DSTATE = 0.0;
    ...
}
```

- 2** Selecting **Function with separate data** generates the following declarations in the `myfun.c` file for `rtwdemo_atomic2`:

```
/* Declare variables for internal data of system '<Root>/SS1' */
rtB_myfun rtwdemo_atomic2_myfunB;

rtDW_myfun rtwdemo_atomic2_myfunDW;
```

By contrast, the generated code for `rtwdemo_atomic1` contains model-level declarations for the subsystem's BlockIO and D_Work data, in `rtwdemo_atomic1.c`:

```
/* Block signals (auto storage) */
BlockIO_rtwdemo_atomic1 rtwdemo_atomic1_B;

/* Block states (auto storage) */
D_Work_rtwdemo_atomic1 rtwdemo_atomic1_DWork;
```

- 3** Selecting **Function with separate data** generates identifier naming that reflects the subsystem orientation of data items. Notice the references to subsystem data in subsystem functions such as `myfun` and `myfun_update` or in the model's `model_step` function. For example, compare this code from `myfun` for `rtwdemo_atomic2`

```
/* DiscreteIntegrator: '<S1>/Integrator' */
rtwdemo_atomic2_myfunB.Integrator = rtwdemo_atomic2_myfunDW.Integrator_DSTATE;
```

to the corresponding code from `myfun` for `rtwdemo_atomic1`.

```
/* DiscreteIntegrator: '<S1>/Integrator' */
rtwdemo_atomic1_B.Integrator = rtwdemo_atomic1_DWork.Integrator_DSTATE;
```

Nonvirtual Subsystem Modular Function Code Limitations

The nonvirtual subsystem option **Function with separate data** has the following limitations:

- The **Function with separate data** option is available only in ERT-based Simulink models (requires a Embedded Coder license).

- The nonvirtual subsystem to which the option is applied cannot have multiple sample times or continuous sample times; that is, the subsystem must be single-rate with a discrete sample time.
- The nonvirtual subsystem cannot contain continuous states.
- The nonvirtual subsystem cannot output function call signals.
- The nonvirtual subsystem cannot contain noninlined S-functions.
- The generated files for the nonvirtual subsystem will reference model-wide header files, such as *model.h* and *model_private.h*.
- The **Function with separate data** option is incompatible with the **Classic call interface** option, located on the **Code Generation > Interface** pane of the Configuration Parameters dialog box. Selecting both will generate an error.
- The **Function with separate data** option is incompatible with the **Generate reusable code** option (**Code Generation > Interface** pane). Selecting both will generate an error.

Memory Sections

- “About Memory Sections” on page 13-2
- “Requirements for Defining Memory Sections” on page 13-3
- “Define Memory Sections” on page 13-5
- “Configure Memory Sections” on page 13-9
- “Declare Constant Data as Volatile” on page 13-10
- “Apply Memory Sections” on page 13-13
- “Generated Code with Memory Sections” on page 13-21
- “Model-Level Data Structures” on page 13-23
- “Memory Section Limitation” on page 13-26

About Memory Sections

What Are Memory Sections?

The Embedded Coder software provides a memory section capability that allows you to insert comments and pragmas and qualify constants as volatile in generated code for

- Data in custom storage classes
- Model-level functions
- Model-level internal data
- Subsystem functions
- Subsystem internal data

Pragmas inserted into generated code can surround

- A contiguous block of function or data definitions
- Each function or data definition separately

When pragmas surround each function or data definition separately, the text of each pragma can contain the name of the definition to which it applies.

To see an example of memory sections, type `rtwdemo_memsec` at the MATLAB command line.

Requirements for Defining Memory Sections

Before you can define memory sections, you must do the following:

- 1** Set the Simulink model's code generation target to an embedded target such as `ert.tlc`.
- 2** To create packages, specify package properties, or create classes, including custom storage classes, see “Define Data Classes” in the Simulink documentation.

See also the instructions that appear when you click the **Custom Storage Classes** tab.

- 3** If you need to specify custom storage class properties,
 - a** Choose **View > Model Explorer** in the model window.

The Model Explorer appears.

- b** Choose **Tools > Custom Storage Class Designer** in the Model Explorer window.

A notification box appears that states **Please Wait ... Finding Packages**. After a brief pause, the notification box closes and the Custom Storage Class Designer appears.

- c** Select the **Custom Storage Class** tab. The **Custom Storage Class** pane initially looks like this:

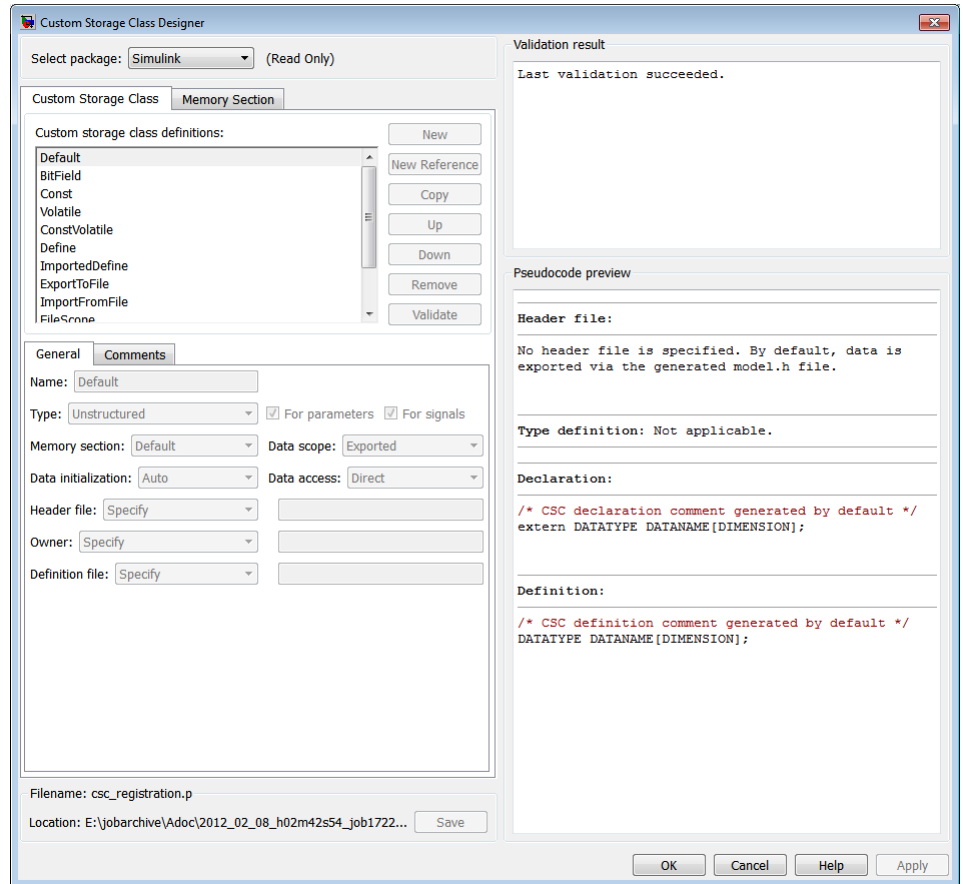

- d Use the **Custom Storage Class** pane to select a writable package and specify custom storage class properties. Instructions for using this pane appear in “Design Custom Storage Classes and Memory Sections” on page 10-8.

Define Memory Sections

In this section...

“Edit Memory Section Properties” on page 13-5

“Specify the Memory Section Name” on page 13-6

“Specify a Qualifier for Custom Storage Class Data Definitions” on page 13-7

“Specify Comment and Pragma Text” on page 13-7

“Surround Individual Definitions with Pragmas” on page 13-7

“Include Identifier Names in Pragmas” on page 13-8

Edit Memory Section Properties

After you have satisfied the requirements in “Requirements for Defining Memory Sections” on page 13-3, you can define memory sections and specify their properties. To create new memory sections or specify memory section properties,

- 1 Choose **View > Model Explorer** in the model window.

The Model Explorer appears.

- 2 Choose **Tools > Custom Storage Class Designer** in the Model Explorer window.

A notification box appears that states **Please Wait ... Finding Packages**. After a brief pause, the notification box closes and the Custom Storage Class Designer appears.

- 3 Click the **Memory Section** tab of the Custom Storage Class Designer. The **Memory Section** pane initially looks like this:

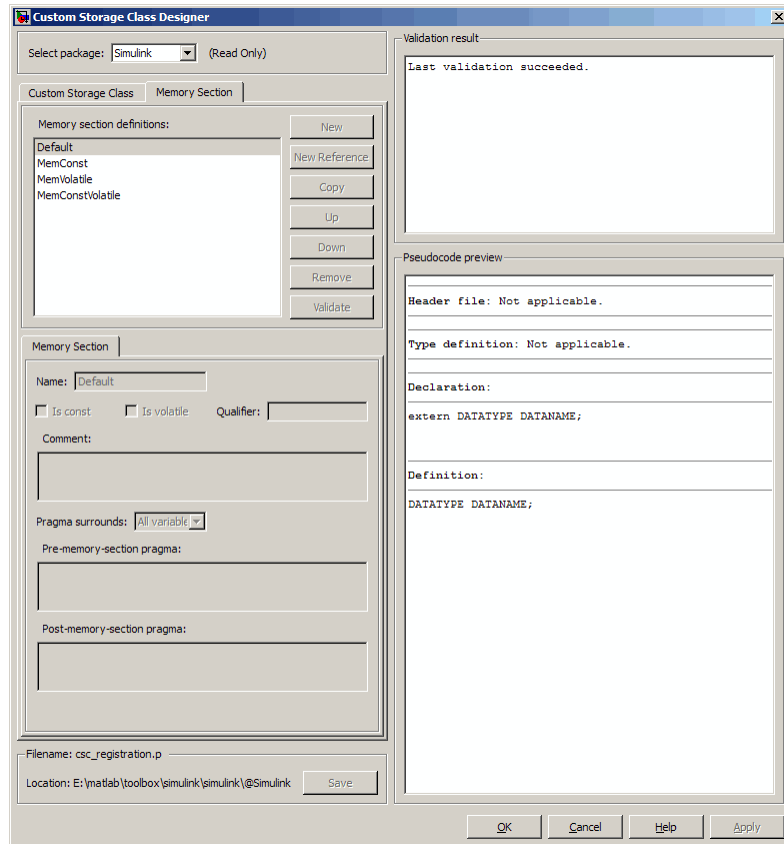

- 4** If you intend to create or change memory section definitions, use the **Select package** field to select a writable package.

The rest of this section assumes that you have selected a writable package, and describes the use of the **Memory section** subpane on the lower left. For descriptions of the other subpanes, instructions for validating memory section definitions, and other information, see “Define Memory Sections” on page 13-5.

Specify the Memory Section Name

To specify the name of a memory section, use the **Name** field. A memory section name must be a legal MATLAB identifier.

Specify a Qualifier for Custom Storage Class Data Definitions

To specify a qualifier for custom storage class data definitions in a memory section, enter the components of the qualifier below the **Name** field.

- To specify `const`, check **Is const**.
- To specify `volatile`, check **Is volatile**.
- To specify anything else (e.g., `static`), enter the text in the **Qualifier** field.

The qualifier will appear in generated code with its components in the same left-to-right order in which their definitions appear in the dialog box. A preview appears in the **Pseudocode preview** subpane on the lower right.

Note Specifying a qualifier affects only custom storage class data definitions. The code generator omits the qualifier from other definition categories.

Specify Comment and Pragma Text

To specify a comment, prepragma, or postpragma for a memory section, enter the comment in the text boxes on the left side of the Custom Storage Class Designer. In the text boxes, you can type multiple lines separated by ordinary Returns.

Surround Individual Definitions with Pragmas

If the **Pragma surrounds** field for a memory section specifies **Each variable**, the code generator will surround each definition in a contiguous block of definitions with the comment, prepragma, and postpragma defined for the section.

If the **Pragma surrounds** field for a memory section specifies **All variables**, the code generator will insert the comment and prepragma for the section before the first definition in a contiguous block of custom storage class data definitions, and the postpragma after the last definition in the block.

Note Specifying **All variables** affects only custom storage class data definitions. For other definition categories, the code generator surrounds each definition separately regardless of the value of **Pragma surrounds**.

Include Identifier Names in Pragmas

When pragmas surround each separate definition in a contiguous block, you can include the string %<identifier> in a pragma. The string must appear without surrounding quotes.

- When %<identifier> appears in a prepragma, the code generator will substitute the identifier from the subsequent function or data definition.
- When %<identifier> appears in a postpragma, the code generator will substitute the identifier from the previous function or data definition.

You can use %<identifier> with pragmas *only* when pragmas to surround each variable. The `Validate` phase will report an error if you violate this rule.

Note Although %<identifier> looks like a TLC variable, it is not: it is just a keyword that directs the code generator to substitute the applicable data definition identifier when it outputs a pragma. TLC variables cannot appear in pragma specifications in the **Memory Section** pane.

Configure Memory Sections

You configure memory sections by using the **Code Generation > Memory Sections** pane of the Configuration Parameters dialog box.

To...	Select...
Specify the package that contains memory sections that you want to apply	The name of a package for Package . Click Refresh package list to refresh the list of available packages in your configuration.
Apply memory sections to initialize/start and terminate functions	A value for Initialize/Terminate .
Apply memory sections to step, run-time initialization, derivative, enable, and disable functions	A value for Execution .
Apply memory sections to constant parameters, constant, block I/O, or zero representation	A value for Constants .
Apply memory sections to root inputs or outputs	A value for Inputs/Outputs .
Apply memory sections to block I/O, Dwork vectors, run-time models, zero-crossings	A value for Internal data .
Apply memory sections to parameters	A value for Parameters .

The interface checks whether the specified package is on the MATLAB path and that the selected memory sections are in the package. The results of this validation appear in the field **Validation results**.

Declare Constant Data as Volatile

In the C language, the value of data declared with the storage type qualifier, `volatile`, can be read from memory and written back to memory when changed without compiler control or detection. Examples of use include variables for initialization at system power-up or for system clock updates.

You can add the `volatile` qualifier to type definitions generated in code for model constant block I/O, constant parameters, and ground data (zero representation).

To add the `volatile` qualifier to type definitions, you must configure your model as follows:

- Enable inline parameters
- Specify an ERT target
- Set the memory section for constant data to `MemVolatile` or `MemConstVolatile`

If you choose to add the `volatile` qualifier to type definitions in your generated code, note the following:

- If constant data that is qualified with `volatile` is passed by pointer, the code generator casts away the volatility. This occurs because generated functions assume that data values do not change during execution and, therefore, pass their arguments as `const *` (not `const volatile *`).
- If a variable must be declared `const` and you specify `MemVolatile`, the code generator declares the variable with the `const` and `volatile` qualifiers.
- If you set **Constants** to `MemConst` or `MemConstVolatile`, and a variable cannot be declared as constant data, a TLC warning appears and the code generator does not qualify the variable with `const`.

Consider the following simple lookup table model.

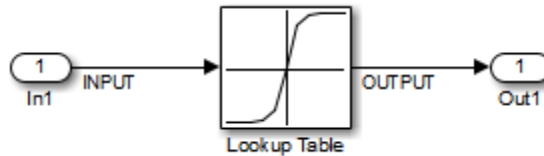

- 1** On the Configuration Parameters dialog box, in the **Optimization > Signals and Parameters** pane, select **Inline parameters**.
- 2** In the **Code Generation** pane, set **System target file** to `ert.tlc`.
- 3** In the **Code Generation > Memory Sections** pane, set **Package** to `Simulink` or `mpt`, and **Constants** to `MemConstVolatile`.
- 4** Open the Signal Properties dialog box for signal `INPUT`. On the **Code Generation** tab, set the **Package** to `Simulink` or `mpt` and the **Storage class** to `ExportedGlobal` for storing state in a global variable.
- 5** Generate code. You should see the volatile qualifier in the generated files `model_data.c` and `model.h`.

`model_data.c`

```

/* Constant parameters (auto storage) */
/* ConstVolatile memory section */
const volatile ConstParam_simple_lookup simple_lookup_ConstP = {
  /* Expression: [-5:5]
   * Referenced by: '<Root>/Lookup Table'
   */
  { -5.0, -4.0, -3.0, -2.0, -1.0, 0.0, 1.0, 2.0, 3.0, 4.0, 5.0 },

  /* Expression: tanh([-5:5])
   * Referenced by: '<Root>/Lookup Table'
   */
  { -0.99990920426259511, -0.999329299739067,
    -0.99505475368673046, -0.9640275800758169,
    -0.76159415595576485, 0.0, 0.76159415595576485,
    0.9640275800758169, 0.99505475368673046,
    0.999329299739067, 0.99990920426259511 }

```

```
};
```

```
model.h
```

```
/* Real-time Model Data Structure */  
struct RT_MODEL_simple_lookup {  
    const char_T * volatile errorStatus;  
};
```

```
/* Constant parameters (auto storage) */  
extern const volatile ConstParam_simple_lookup simple_lookup_ConstP;
```

Also note in the *model.c* file that a typecast is inserted in the `rt_Lookup` function call, removing the `volatile` qualifier.

```
/* Lookup: '<Root>/Lookup Table' incorporates:  
 * Inport: '<Root>/In1'  
 */
```

```
OUTPUT = rt_Lookup(((const real_T*)  
    &simple_lookup_ConstP.LookupTable_XData[0]), 11, INPUT, ((  
    const real_T*) &simple_lookup_ConstP.LookupTable_YData[0]));
```

Apply Memory Sections

In this section...
“Assign Memory Sections to Custom Storage Classes” on page 13-13
“Apply Memory Sections to Model-Level Functions and Internal Data” on page 13-15
“Apply Memory Sections to Atomic Subsystems” on page 13-17

Assign Memory Sections to Custom Storage Classes

To assign a memory section to a custom storage class,

- 1 Choose **View > Model Explorer** in the model window.

The Model Explorer appears.

- 2 Choose **Tools > Custom Storage Class Designer** in the Model Explorer window.

A notification box appears that states **Please Wait ... Finding Packages**. After a brief pause, the notification box closes and the Custom Storage Class Designer appears.

- 3 Select the **Custom Storage Class** tab. The **Custom Storage Class** pane initially looks like this:

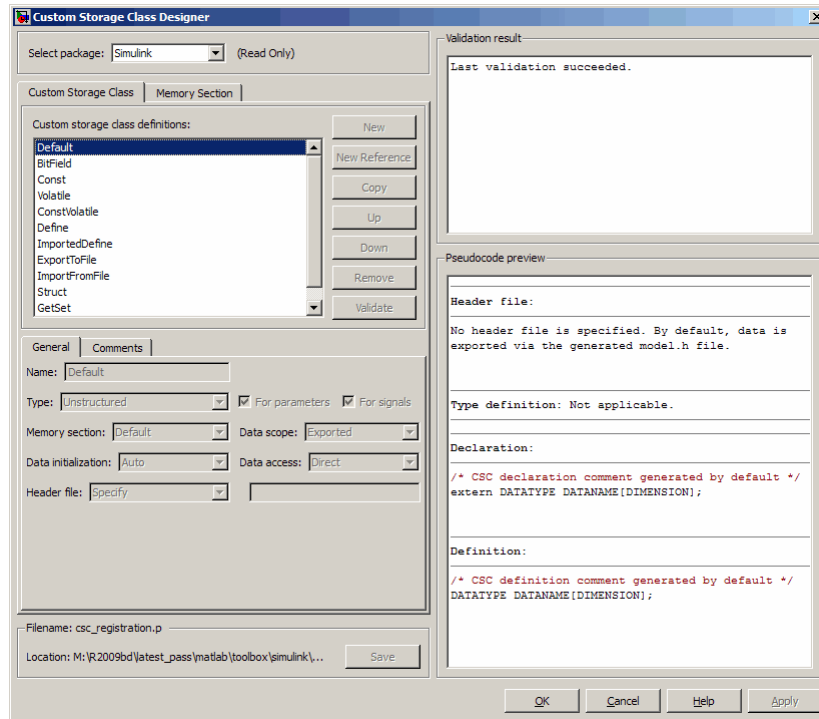

- 4 Use the **Select package** field to select a writable package. The rest of this section assumes that you have selected a writable package.
- 5 Select the desired custom storage class in the **Custom storage class definitions** pane.
- 6 Select the desired memory section from the **Memory section** pull-down.
- 7 Click **Apply** to apply changes to the open copy of the model; **Save** to apply changes and save them to disk; or **OK** to apply changes, save changes, and close the Custom Storage Class Designer.

Generated code for data definitions in the specified custom storage class are enclosed in the pragmas of the specified memory section. The pragmas can surround contiguous blocks of definitions or each definition separately, as described in “Surround Individual Definitions with Pragmas” on page 13-7.

For more information, see “Design Custom Storage Classes and Memory Sections” on page 10-8.

Note The code generator does not generate a `pragma` around definitions or declarations for data that has the following built-in storage classes:

- `ExportedGlobal`
- `ImportedExtern`
- `ImportedExternPointer`

The code generator treats data with these built-in storage classes like custom storage classes without a specified memory section.

Apply Memory Sections to Model-Level Functions and Internal Data

When using code generation software, you can apply memory sections to the following categories of model-level functions:

Function Category	Function Subcategory
Initialize/Terminate functions	Initialize/Start
	Terminate
Execution functions	Step functions
	Run-time initialization
	Derivative
	Enable
	Disable

When using code generation software, you can apply memory sections to the following categories of internal data:

Data Category	Data Definition	Data Purpose
Constants	<i>model_cP</i>	Constant parameters
	<i>model_cB</i>	Constant block I/O
	<i>model_Z</i>	Zero representation
Input/Output	<i>model_U</i>	Root inputs
	<i>model_Y</i>	Root outputs
Internal data	<i>model_B</i>	Block I/O
	<i>model_D</i>	D-work vectors
	<i>model_M</i>	Run-time model
	<i>model_Zero</i>	Zero-crossings
Parameters	<i>model_P</i>	Parameters

Memory section specifications for model-level functions and internal data apply to the top level of the model and to its subsystems. However, these specifications are not applicable to atomic subsystems that contain overriding memory section specifications, as described in “Apply Memory Sections to Atomic Subsystems” on page 13-17.

To specify memory sections for model-level functions or internal data,

- 1** Open the Configuration Parameters dialog box and select **Code Generation > General**.
- 2** Specify the **System target file** as an ERT target, such as `ert.tlc`.

3 Select **Memory Sections**. The **Memory Sections** pane looks like this:

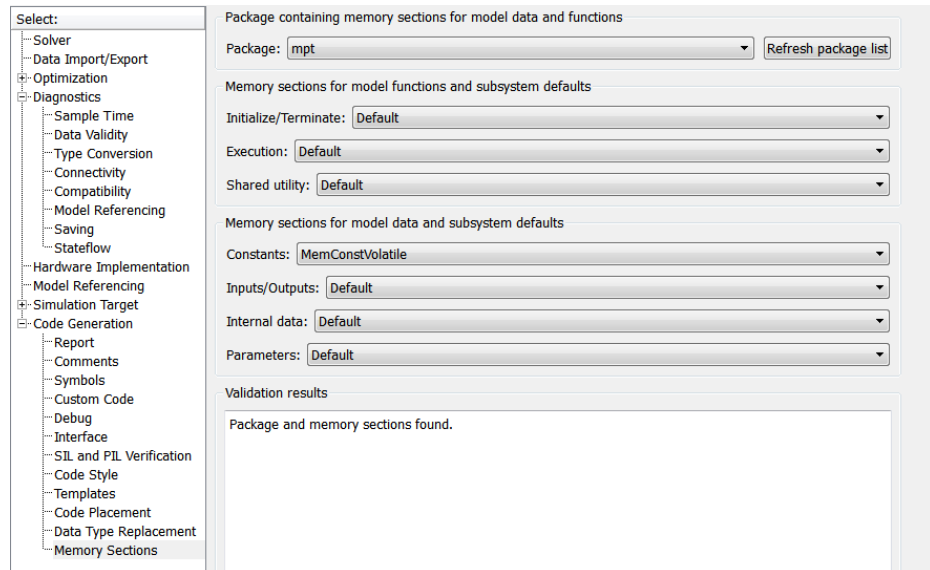

- 4** Initially, the **Package** field specifies `---None---` and the pull-down lists only built-in packages. If you have defined packages of your own, click **Refresh package list**. This action adds user-defined packages on your search path to the package list.
- 5** In the **Package** pull-down, select the package that contains the memory sections that you want to apply.
- 6** In the pull-down for each category of internal data and model-level function, specify the memory section that you want to apply to that category. Accepting or specifying **Default** omits specifying memory section for that category.
- 7** Click **Apply** to save changes to the package and memory section selections.

Apply Memory Sections to Atomic Subsystems

For atomic subsystem whose generated code format is `Function` or `Reusable Function`, you can specify memory sections for functions and internal data that exist in that code format. Such specifications override model-level

memory section specifications. Such overrides apply only to the atomic subsystem itself, not to subsystems within it. Subsystems of an atomic subsystem inherit memory section specifications from the containing model, *not* from the containing atomic subsystem.

To specify memory sections for an atomic subsystem,

- 1** Right-click the subsystem in the model window.
- 2** Choose **Subsystem Parameters** from the context menu. The Function Block Parameters: *Subsystem* dialog box appears.
- 3** Select the **Treat as atomic unit** checkbox. If it is not selected, you cannot specify memory sections for the subsystem.

For an atomic system, on the **Code Generation** tab, you can use the **Function packaging** field to control the format of the generated code.

- 4** Specify **Function packaging** as **Nonreusable function** or **Reusable function**. Otherwise, you cannot specify memory sections for the subsystem.
- 5** If the code format is **Function** and you want separate data, check **Function with separate data**.

The **Code Generation** tab now shows applicable memory section options. The available options depend on the values of **Function packaging** and the **Function with separate data** check box. When the former is **Nonreusable function** and the latter is checked, the pane looks like this:

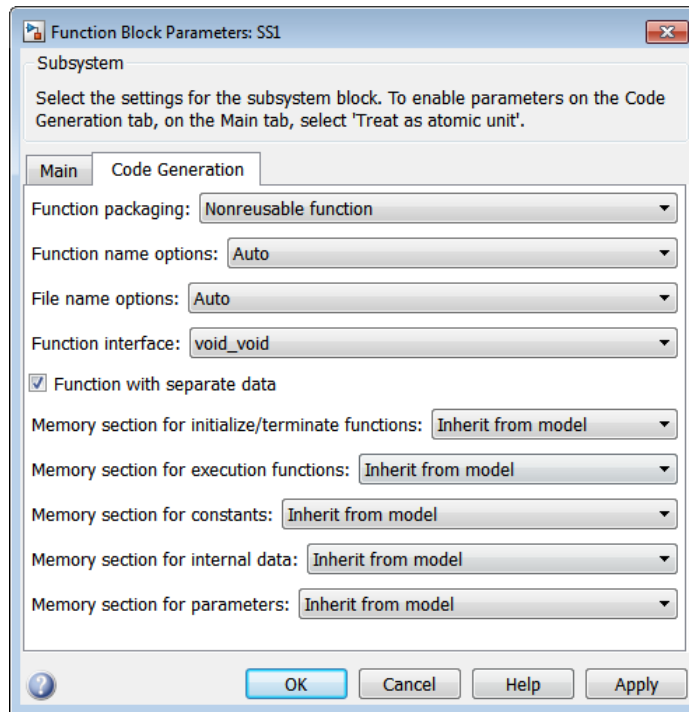

- 6 In the pull-down for each available definition category, specify the memory section that you want to apply to that category.
 - Selecting `Inherit from model` inherits the corresponding selection from the model level (not parent subsystem).
 - Selecting `Default` specifies that the category does not have an associated memory section, overriding model-level specifications for that category.
- 7 Click **Apply** to save changes, or **OK** to save changes and close the dialog box.

Caution If you use **Build This Subsystem** or **Build Selected Subsystem** to generate code for an atomic subsystem that specifies memory sections, the code generator ignores the subsystem-level specifications and uses the model-level specifications instead. The generated code is the same as if the atomic subsystem specified `Inherit from model` for every category of definition. For information about building subsystems, see “Generate Code and Executables for Individual Subsystem”.

It is not possible to specify the memory section for a subsystem in a library. However, you can specify the memory section for the subsystem after you have copied it into a Simulink model. This is because in the library it is unknown what code generation target will be used. You can copy a library block into many different models with different code generation targets and different memory sections available.

Generated Code with Memory Sections

Sample ERT-Based Model with Subsystem

The next figures show an ERT-based Simulink model that defines one subsystem, mySubsystem, and then the contents of that subsystem.

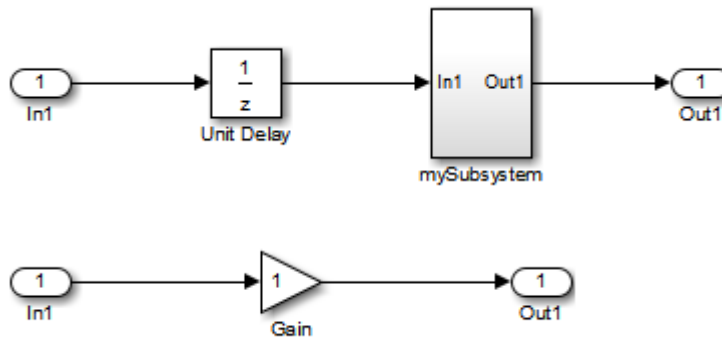

Assume that the subsystem is atomic. On the **Code Generation** tab, the **Function packaging** parameter is Reusable function. Memory sections have been created and assigned as shown in the next two tables; here, data memory sections specify **Pragma surrounds** to be Each variable.

Model-Level Memory Section Assignments and Definitions

Section Assignment	Section Name	Field Name	Field Value
Input/Output	MemSect1	Prepragma	#pragma IO_begin
		Postpragma	#pragma IO-end
Internal data	MemSect2	Prepragma	#pragma InData-begin(%<identifier>)
		Postpragma	#pragma InData-end
Parameters	MemSect3	Prepragma	#pragma Parameters-begin
		Postpragma	#pragma Parameters-end

Model-Level Memory Section Assignments and Definitions (Continued)

Section Assignment	Section Name	Field Name	Field Value
Initialize/ Terminate	MemSect4	Prepragma	#pragma InitTerminate-begin
		Postpragma	#pragma InitTerminate-end
Execution functions	MemSect5	Prepragma	#pragma ExecFunc-begin(%<identifier>)
		Postpragma	#pragma ExecFunc-begin(%<identifier>)

Subsystem-Level Memory Section Assignments and Definitions

Section Assignment	Section Name	Field Name	Field Value
Execution functions	MemSect6	Prepragma	#pragma DATA_SEC(%<identifier>, "FAST_RAM")
		Postpragma	

Given the preceding specifications and definitions, the code generator would create the following code, with minor variations depending on the current version of the Target Language Compiler.

Model-Level Data Structures

```

#pragma IO-begin
ExternalInputs_mySample mySample_U;
#pragma IO-end

#pragma IO-begin
ExternalOutputs_mySample mySample_Y;
#pragma IO-end

#pragma InData-begin(mySample_B)
BlockIO_mySample mySample_B;
#pragma InData-end

#pragma InData-begin(mySample_DWork)
D_Work_mySample mySample_DWork;
#pragma InData-end

#pragma InData-begin(mySample_M_)
RT_MODEL_mySample mySample_M_;
#pragma InData-end

#pragma InData-begin(mySample_M)
RT_MODEL_mySample *mySample_M = &mySample_M_;
#pragma InData-end

#pragma Parameters-begin
Parameters_mySample mySample_P = {
    0.0 , {2.3}
};
#pragma Parameters-end

```

Model-Level Functions

```

#pragma ExecFunc-begin(mySample_step)
void mySample_step(void)
{
    real_T rtb_UnitDelay;
    rtb_UnitDelay = mySample_DWork.UnitDelay_DSTATE;
    mySubsystem(rtb_UnitDelay, &mySample_B.mySubsystem;,

```

```
        (rtP_mySubsystem *) &mySample_P.mySubsystem);
    mySample_Y.Out1_o = mySample_B.mySubsystem.Gain;
    mySample_DWork.UnitDelay_DSTATE = mySample_U.In1;
}
#pragma ExecFunc-end(mySample_step)

#pragma InitTerminate-begin
void mySample_initialize(void)
{
    rtmSetErrorStatus(mySample_M, (const char_T *)0);
    {
        ((real_T*)&mySample_B.mySubsystem.Gain)[0] = 0.0;
    }
    mySample_DWork.UnitDelay_DSTATE = 0.0;
    mySample_U.In1 = 0.0;
    mySample_Y.Out1_o = 0.0;
    mySample_DWork.UnitDelay_DSTATE = mySample_P.UnitDelay_X0;
}
#pragma InitTerminate-end
```

Subsystem Function

Because the subsystem specifies a memory section for execution functions that overrides that of the parent model, subsystem code looks like this:

```
/* File: mySubsystem.c */

#pragma DATA_SEC(mySubsystem, FAST_RAM )
void mySubsystem(real_T rtu_In1,
rtB_mySubsystem *localB,
rtP_mySubsystem *localP)
{
    localB->Gain = rtu_In1 * localP->Gain_Gain;
}

```

If the subsystem had not defined its own memory section for execution functions, but inherited that of the parent model, the subsystem code would have looked like this:

```
/* File: mySubsystem.c */
```



```
#pragma ExecFunc-begin(mySubsystem)
void mySubsystem(real_T rtu_In1,
rtB_mySubsystem *localB,
rtP_mySubsystem *localP)
{
    localB->Gain = rtu_In1 * localP->Gain_Gain;
}
#pragma ExecFunc-end(mySubsystem)
```

Memory Section Limitation

Memory sections cannot be applied to shared utility functions, such as lookup table functions, data type conversion functions, and fixed-point functions. For information about shared utilities, see “Logging” and “Supporting the Shared Utilities Folder”.

Code Generation

- Chapter 14, “Configuration”
- Chapter 15, “Code Appearance”
- Chapter 16, “Source Code Generation”
- Chapter 17, “Code Generation for AUTOSAR Software Components”
- Chapter 18, “Report Generation”

Configuration

- “Application Objectives” on page 14-2
- “High-Level Code Generation Objectives” on page 14-3
- “Determine Model Configuration for Specified Objectives” on page 14-5
- “Check and Configure Model for Code Generation Objectives” on page 14-6
- “Check and Configure Model for Code Generation Objectives Using Configuration Parameters Dialog Box” on page 14-10
- “Configure Code Generation Objectives Programmatically” on page 14-13
- “Check Objectives in Referenced Models” on page 14-14
- “Check Model During Code Generation” on page 14-15
- “Create Custom Objectives” on page 14-17
- “Target” on page 14-24
- “Configuration Variations” on page 14-32
- “Wizard” on page 14-33

Application Objectives

The first step in applying Embedded Coder configuration options to the application development process is to consider how your application objectives, particularly with respect to efficiency, traceability, and safety, map to code generation options in a model configuration set.

Parameters that you set in the **Solver**, **Data Import/Export**, **Diagnostics**, and **Code Generation** panes of the Configuration Parameters dialog box specify the behavior of a model in simulation and the code generated for the model.

Consider questions such as the following:

- What settings might help you debug your application?
- What is the highest objective for your application — efficiency, traceability, extra safety precaution, debugging, or some other criteria?
- What is the second highest objective?
- Can the objective at the start of the project differ from the objective required for the end result? What tradeoffs can you make?

After you answer these questions, you must:

- Define your objectives in the configuration set. For more information, see “High-Level Code Generation Objectives” on page 14-3.
- Use the Code Generation Advisor to identify parameter values that are not configured for the objectives that you selected. For more information, see “Determine Model Configuration for Specified Objectives” on page 14-5.

High-Level Code Generation Objectives

Depending on the type of application that your model represents, you are likely to have specific code generation objectives. For example, safety and traceability might be more critical than efficient use of memory. If you have specific objectives, you can quickly configure your model to meet those objectives by selecting and prioritizing from these code generation objectives:

- Execution efficiency (all targets) — Configure code generation settings to achieve fast execution time.
- ROM efficiency (ERT-based targets) — Configure code generation settings to reduce ROM usage.
- RAM efficiency (ERT-based targets) — Configure code generation settings to reduce RAM usage.
- Traceability (ERT-based targets) — Configure code generation settings to provide mapping between model elements and code.
- Safety precaution (ERT-based targets) — Configure code generation settings to increase clarity, determinism, robustness, and verifiability of the code.
- Debugging (all targets) — Configure code generation settings to debug the code generation build process.
- MISRA-C:2004 guidelines (ERT-based targets) — Configure code generation settings to increase compliance with MISRA-C:2004 guidelines.

Based on your objective selections and prioritization, the Code Generation Advisor checks your model and suggests changes that you can make to achieve your code generation objectives.

Note If you select the MISRA-C:2004 guidelines code generation objective, the Code Generation Advisor checks:

- The model configuration settings for compliance with the MISRA-C:2004 configuration setting recommendations.
 - For blocks that are not supported or recommended for MISRA-C:2004 compliant code generation.
-

Setting code generation objectives and running the Code Generation Advisor provides information on how to meet code generation objectives for your model. The Code Generation Advisor does not alter the generated code. You can use the Code Generation Advisor to make the suggested changes to your model. The generated code is changed only after you modify your model and regenerate code. If you use the Code Generation Advisor to set code generation objectives and check your model, the generated code includes comments identifying which objectives you specified, the checks the Code Generation Advisor ran on the model, and the results of running the checks.

Determine Model Configuration for Specified Objectives

You can use the Code Generation Advisor to review your model and identify the parameters that are not configured for your objective. The Code Generation Advisor reviews a subset of model configuration parameters. It displays the results in the **Check model configuration settings against code generation objectives** check.

The Code Generation Advisor uses the information presented in “Recommended Settings Summary” to determine the values. When there is a conflict due to multiple objectives, the higher-priority objective takes precedence.

You can use the Code Generation Advisor to review a model before generating code, or as part of the code generation process. When you choose to review a model before generating code, you specify which model, subsystem, or referenced model the Code Generation Advisor reviews. When you choose to review a model as part of the code generation process, the Code Generation Advisor reviews the entire system.

Check and Configure Model for Code Generation Objectives

This example shows how to configure and check your model to meet code generation objectives:

- 1 On the menu bar, select **Code > C/C++ Code > Code Generation Advisor**. Alternatively:
 - On the toolbar  drop-down list, select **Code Generation Advisor**.
 - Right-click a subsystem, and then select **C/C++ Code > Code Generation Advisor**. Go to step 3.
- 2 In the System Selector window, select the model or subsystem that you want to review, and then click **OK**.
- 3 In the Code Generation Advisor, on the **Code Generation Objectives** pane, select the code generation objectives. As you select objectives, on the left pane, the Code Generation Advisor updates the list of checks it will run on your model. If your model is configured with an ERT-based target, more objectives are available. For this example, the model is configured with an ERT-based target. If your objectives are execution efficiency and traceability, in that priority, do the following:
 - a In **Available objectives**, double-click **Execution efficiency**. **Execution efficiency** is added to **Selected objectives - prioritized**.
 - b In **Available objectives**, double-click **Traceability**. **Traceability** is added to **Selected objectives - prioritized** below **Execution efficiency**.

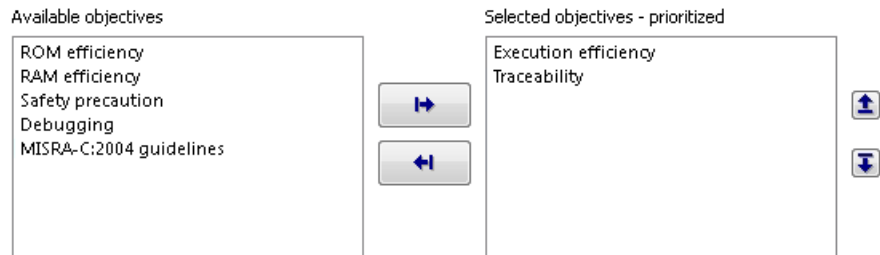

- 4** Click **Run Selected Checks** to run the checks listed in the left pane of the Code Generation Advisor.
- 5** In the Code Generation Advisor window, review the results for **Check model configuration settings against code generation objectives** by selecting it from the left pane. The results for that check are displayed in the right pane.

Check model configuration settings against code generation objectives triggers a warning for either of these reasons:

- Parameters are set to values other than the value recommended for the specified code generation objectives.
- Selected code generation objectives differ from the objectives set in the model.

Click **Modify Parameters** to set:

- Parameter to the value recommended for the specified code generation objectives.
- Code generation objectives in the model to the objectives specified in the Code Generation Advisor.

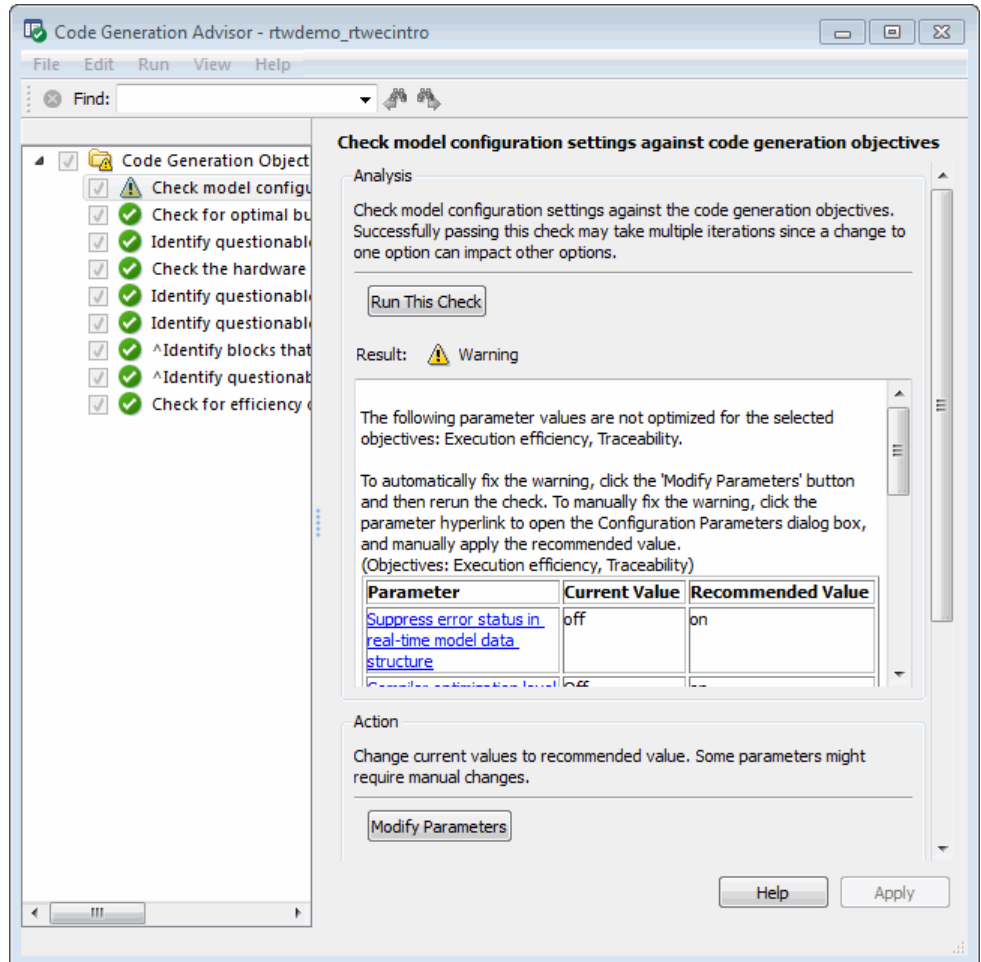

- 6 In the Code Generation Advisor window, review the results for the remaining checks by selecting them from the left pane. The right pane populates the results for the checks.
- 7 After reviewing the check results, you can choose to fix warnings and failures, as described in “Fix a Warning or Failure”.

Note When you specify an efficiency or safety precaution objective, the Code Generation Advisor includes additional checks.

When you make changes to one check, the other check results could become invalid. You must run the checks again.

Check and Configure Model for Code Generation Objectives Using Configuration Parameters Dialog Box

This example shows how to configure and check your model to meet code generation objectives using the Configuration Parameters dialog box:

- 1 Open the Configuration Parameters dialog box. Select **Code Generation**.
- 2 Specify a system target file. If you specify an ERT-based target, more objectives are available. For this example, choose an ERT-based target such as `ert.tlc`.
- 3 Click **Set objectives**.
- 4 In the “Set Objectives — Code Generation Advisor Dialog Box”, specify your objectives. For example, if your objectives are execution efficiency and traceability, in that priority, do the following:
 - a In **Available objectives**, double-click Execution efficiency. Execution efficiency is added to **Selected objectives - prioritized**.
 - b In **Available objectives**, double-click Traceability. Traceability is added to **Selected objectives - prioritized** below Execution efficiency.

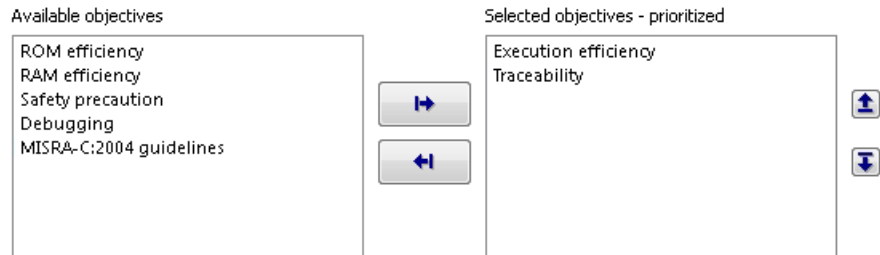

- c Click **OK** to accept the objectives. In the Configuration Parameters dialog box, **Code Generation > General > Prioritized objectives** is updated.
- 5 On the **Configuration Parameters > Code Generation > General** pane, click **Check model**.

- 6 In the System Selector window, select the model or subsystem that you want to review, and then click **OK**. The Code Generation Advisor opens and reviews the model or subsystem that you specified.
- 7 In the Code Generation Advisor window, review the results by selecting a check from the left pane. The right pane populates the results for that check.

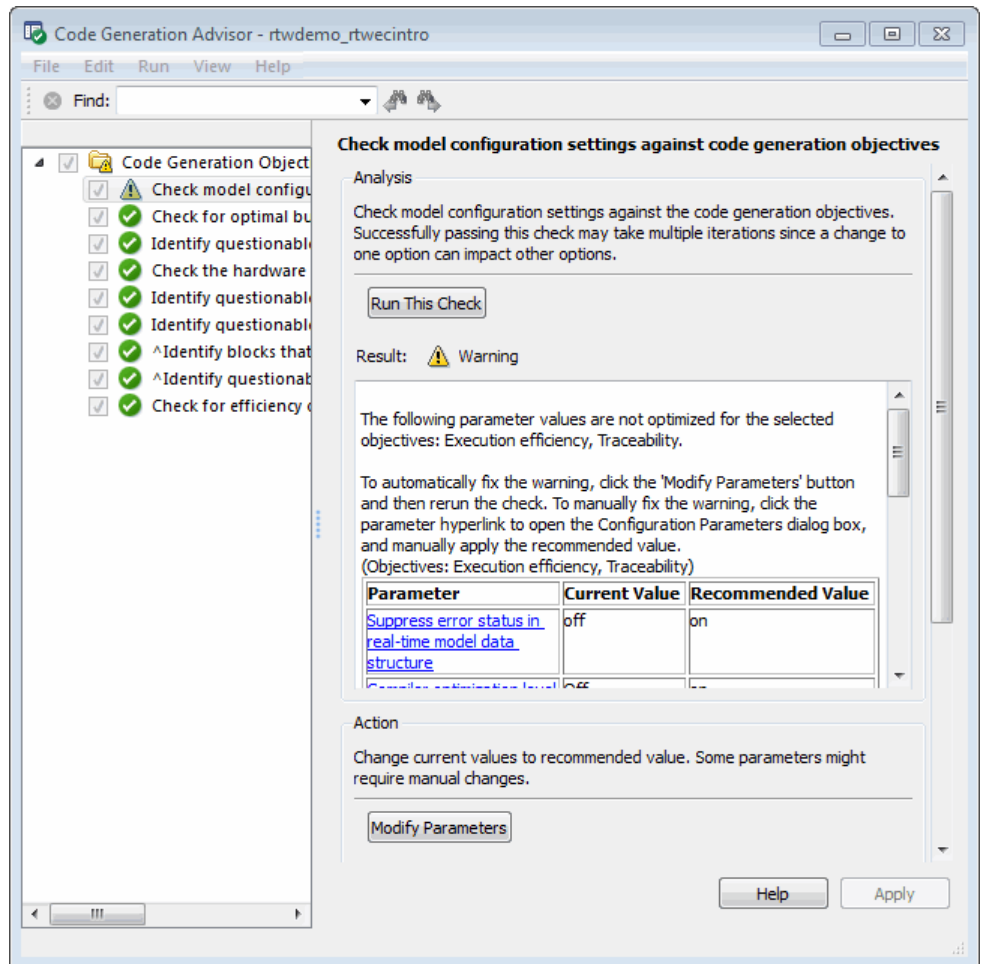

- 8 After reviewing the check results, you can choose to fix warnings and failures, as described in “Fix a Warning or Failure”.

Note When you specify an efficiency or safety precaution objective, the Code Generation Advisor includes additional checks. When you make changes to one check, the other check results could become invalid and you must run the checks again.

For more information, see “Set Objectives — Code Generation Advisor Dialog Box”

Configure Code Generation Objectives Programmatically

This example shows how to configure code generation objectives by writing a MATLAB script or entering commands at the command line.

- 1 Specify a system target file. If you specify an ERT-based target, more objectives are available. For this example, specify `ert.tlc`. *model_name* is the name or handle to the model.

```
set_param(model_name, 'SystemTargetFile', 'ert.tlc');
```

- 2 Specify your objectives. For example, if your objectives are execution efficiency and traceability, in that priority, enter:

```
set_param(model_name, 'ObjectivePriorities', ...  
{'Execution efficiency', 'Traceability'});
```

Note When you specify a GRT-based system target file, you can specify an objective at the command line. If you specify ROM efficiency, RAM efficiency, Traceability, MISRA-C:2004 guidelines, or Safety precaution, the build process changes the objective to `Unspecified` because you have specified a value that is invalid when using a GRT-based target.

Check Objectives in Referenced Models

When you check a model during the code generation process, you must specify the same objectives in the top model and referenced models. If you specify different objectives for the top model and referenced model, the build process generates an error.

To specify different objectives for the top model and each referenced model, review the models separately without generating code.

Check Model During Code Generation

This example shows how to use the Code Generation Advisor to review a model as part of the code generation process.

- 1 Specify your code generation objectives.
- 2 On the **Configuration Parameters > Code Generation > General** pane, select one of the following from **Check model before generating code**:
 - On (proceed with warnings)
 - On (stop for warnings)
- 3 If you only want to generate code, select **Generate code only**; otherwise clear the check box to build an executable.
- 4 Apply your changes, and then click **Generate code/Build**. The Code Generation Advisor starts and reviews the top model and subsystems.

If the Code Generation Advisor issues failures or warnings, and you specified:

- On (proceed with warnings) — The Code Generation Advisor window opens while the build process proceeds. After the build process is complete, you can review the results.
 - On (stop for warnings) — The build process halts and displays the diagnostics viewer. To continue, you must review and resolve the Code Generation Advisor results or change the **Check model before generating code** selection.
- 5 In the Code Generation Advisor window, review the results by selecting a check from the left pane. The right pane populates the results for that check.
 - 6 After reviewing the check results, you can choose to fix warnings and failures as described in “Fix a Warning or Failure”.

Note When you specify an efficiency or safety precaution objective, the Code Generation Advisor includes additional checks. When you make changes to one of these checks, the other check results could become invalid and you must run the check again.

For more information, see “Set Objectives — Code Generation Advisor Dialog Box”

Create Custom Objectives

In this section...

“Specify Parameters in Custom Objectives” on page 14-17

“Specify Checks in Custom Objectives” on page 14-18

“Determine Checks and Parameters in Existing Objectives” on page 14-19

“How to Create Custom Objectives” on page 14-20

The Code Generation Advisor reviews your model based on objectives that you specify. If the predefined efficiency, traceability, safety precaution, and debugging objectives do not meet your requirements, you can create custom objectives.

You can create custom objectives by:

- Creating a new objective and adding parameters and checks to a new objective.
- Creating a new objective based on an existing objective, then adding, modifying, and removing the parameters and checks within the new objective.

Specify Parameters in Custom Objectives

When you create a custom objective, you specify the values of configuration parameters that the Code Generation Advisor reviews. You can use the following methods:

- `addParam` — Add parameters and specify the values that the Code Generation Advisor reviews in **Check model configuration settings against code generation objectives**. When you add parameters that have dependencies, the software includes the dependencies in the list of parameter values that the Code Generation Advisor reviews.
- `modifyInheritedParam` — Modify inherited parameter values that the Code Generation Advisor reviews in **Check model configuration settings against code generation objectives**.

- `removeInheritedParam` — Remove inherited parameters from a new objective that is based on an existing objective. When a user selects multiple objectives, if another selected objective includes this parameter, the Code Generation Advisor reviews the parameter value in **Check model configuration settings against code generation objectives**.

Specify Checks in Custom Objectives

Objectives include the **Check model configuration settings against code generation objectives** check by default. When you create a custom objective, you specify the list of additional checks that are associated with the custom objective. You can use the following methods:

- `addCheck` — Add checks to the Code Generation Advisor. When a user selects the custom objective, the Code Generation Advisor displays the check, unless the user specifies an additional objective with a higher priority that excludes the check.

For example, you might add a check to the Code Generation Advisor to include a custom check in the automatic model checking process.

- `excludeCheck` — Exclude checks from the Code Generation Advisor. When a user selects multiple objectives, if the user specifies an additional objective that includes this check as a higher priority objective, the Code Generation Advisor displays this check.

For example, you might exclude a check from the Code Generation Advisor when a check takes a long time to process.

- `removeInheritedCheck` — Remove inherited checks from a new objective that is based on an existing objective. When a user selects multiple objectives, if another selected objective includes this check, the Code Generation Advisor displays the check.

For example, you might remove an inherited check, rather than exclude the check, when the check takes a long time to process, but the check is important for another objective.

Determine Checks and Parameters in Existing Objectives

When you base a new objective on an existing objective, you can determine what checks and parameters the existing objective contains. The Code Generation Advisor contains the list of checks in each objective.

For example, the `Efficiency` objective includes checks which you can see in the Code Generation Advisor. To see the checks in the Code Generation Advisor:

- 1** Open the `rtwdemo_rtwecintro` model.
- 2** Specify an ERT-based target.
- 3** On the model toolbar, select **Code > C/C++ Code > Code Generation Advisor**.
- 4** In the System Selector window, select the model or subsystem that you want to review, and then click **OK**.
- 5** In the Code Generation Advisor, on the **Code Generation Objectives** pane, select the code generation objectives. As you select objectives, on the left pane, the Code Generation Advisor updates the list of checks it will run on your model. For this example, select `Execution efficiency`.
 - In **Available objectives**, double-click `Execution efficiency`.
`Execution efficiency` is added to **Selected objectives - prioritized**.

In the left pane, the Code Generation Advisor lists the checks for the `Execution efficiency` objective. The first check, **Check model configuration settings against code generation objectives**, lists parameters and values specified by the objective. For example, the Code Generation Advisor displays the list of parameters and the recommended values in the `Execution efficiency` objective. To see the list of parameters and values:

- 1** Run **Check model configuration settings against code generation objectives**.
- 2** Click **Modify Parameters**.

3 Rerun the check.

In the check results, the Code Generation Advisor displays the list of parameters and recommended values for the Execution efficiency objective.

Passed

(Objectives: Execution efficiency)

The following parameters have been checked and confirmed with the recommended value

Parameter	Value
non-inlined S-functions	off
Suppress error status in real-time model data structure	on
MAT-file logging	off
Classic call interface	off
continuous time	off
non-finite numbers	off
Single output/update function	on
Minimize algebraic loop occurrences	off

How to Create Custom Objectives

To create a custom objective:

1 Create an `sl_customization.m` file.

- Specify custom objectives in a single `sl_customization.m` file only, or the software generates an error. This issue is true even if you have more than one `sl_customization.m` file on your MATLAB path.
- Except for the `matlabroot/work` folder, do not place an `sl_customization.m` file in your root MATLAB folder, or its subfolders. Otherwise, the software ignores the customizations that the file specifies.

2 Create an `sl_customization` function that takes a single argument.

When the software invokes the function, the value of this argument is the Simulink customization manager. In the function:

- ▣ Create a handle to the code generation objective, using the `ObjectiveCustomizer` constructor.

- b** Register a callback function for the custom objectives, using the `ObjectiveCustomizer.addCallbackObjFcn` method.
- c** Add a call to execute the callback function, using the `ObjectiveCustomizer.callbackFcn` method.

For example:

```
function sl_customization(cm)
%SL_CUSTOMIZATION objective customization callback

objCustomizer = cm.ObjectiveCustomizer;
index = objCustomizer.addCallbackObjFcn(@addObjectives);
objCustomizer.callbackFcn{index}();

end
```

3 Create a MATLAB callback function that:

- Creates code generation objective objects using the `rtw.codegenObjectives.Objective` constructor.
- Adds, modifies, and removes configuration parameters for each objective using the `addParam`, `modifyInheritedParam`, and `removeInheritedParam` methods.
- Includes and excludes checks for each objective using the `addCheck`, `excludeCheck`, and `removeInheritedCheck` methods.
- Registers objectives using the `register` method.

The following example shows how to create an objective, `Reduce RAM Example`. `Reduce RAM Example` includes five parameters and three checks that the Code Generation Advisor reviews.

```
function addObjectives

% Create the custom objective
obj = rtw.codegenObjectives.Objective('ex_ram_1');
setObjectiveName(obj, 'Reduce RAM Example');

% Add parameters to the objective
addParam(obj, 'InlineParams', 'on');
```

```
addParam(obj, 'BooleanDataType', 'on');
addParam(obj, 'OptimizeBlockIOStorage', 'on');
addParam(obj, 'EnhancedBackFolding', 'on');
addParam(obj, 'BooleansAsBitFields', 'on');

% Add additional checks to the objective
% The Code Generation Advisor automatically includes 'Check model
% configuration settings against code generation objectives' in every
% objective.
addCheck(obj, 'mathworks.design.UnconnectedLinesPorts');
addCheck(obj, 'mathworks.design.Update');

%Register the objective
register(obj);

end
```

The following example shows you how to create an objective, **My Traceability Example**, based on the existing Traceability objective. The custom objective modifies, removes, and adds parameters that the Code Generation Advisor reviews. It also adds and removes checks from the Code Generation Advisor.

```
function addObjectives

% Create the custom objective from an existing objective
obj = rtw.codegenObjectives.Objective('ex_my_trace_1', 'Traceability');
setObjectiveName(obj, 'My Traceability Example');

% Modify parameters in the objective
modifyInheritedParam(obj, 'GenerateTraceReportSf', 'Off');
removeInheritedParam(obj, 'ConditionallyExecuteInputs');
addParam(obj, 'MatFileLogging', 'On');

% Modify checks in the objective
addCheck(obj, 'mathworks.codegen.SWEnvironmentSpec');
removeInheritedCheck(obj, 'mathworks.codegen.CodeInstrumentation');

%Register the objective
register(obj);
```

end

- 4** If you previously opened the Code Generation Advisor, close the model from which you opened the Code Generation Advisor.
- 5** Refresh the customization manager. At the MATLAB command line, enter the `sl_refresh_customizations` command.
- 6** Open your model and review the new objectives.

Target

In this section...

“About Target Selection” on page 14-24

“Select an ERT Target” on page 14-25

“Customize an ERT Target” on page 14-26

“Configure Support for Numeric Data” on page 14-26

“Configure Support for Time Values” on page 14-27

“Support for Non-inlined S-Functions” on page 14-27

“Configure Model Function Generation and Argument Passing” on page 14-28

“Set Up Support for Code Reuse” on page 14-29

“Configure Code Replacement Libraries” on page 14-31

About Target Selection

The first step to configuring a model for code generation is to choose and configure a code generation target. When you select a target, other model configuration parameters change automatically to best serve requirements of the target. For example:

- Code interface parameters
- Build process parameters, such as the template make file
- Target hardware parameters, such as word size and byte ordering

Use the **Browse** button on the **Code Generation** pane to open the System Target File Browser (see “Selecting a Target”. The browser lets you select a preset target configuration consisting of a system target file, template makefile, and make command.

If you select a target configuration by using the System Target File Browser, your selection appears in the **System target file** field (*target.tlc*).

If you are using a target configuration that does not appear in the System Target File Browser, enter the name of your system target file in the **System target file** field. Click **Apply** or **OK** to configure for that target.

“Targets and Code Formats” describes the use of the browser and includes a complete list of available target configurations.

You also can select a system target file programmatically from MATLAB code, as described in “Selecting a System Target File Programmatically”.

After selecting a system target, you can modify model configuration parameter settings.

If you want to switch between different targets in a single workflow for different code generation purposes (for example, rapid prototyping versus product code deployment), set up different configuration sets for the same model and switch the active configuration set for the current operation. For more information on how to set up configuration sets and change the active configuration set, see “Manage a Configuration Set”.

Select an ERT Target

The **Browse** button in the **Target Selection** subpane of the **Code Generation > General** pane lets you select an ERT target with the System Target File Browser. See “Targets and Code Formats” for a general discussion of target selection.

The code generator provides variants of the ERT target including the following:

- Default ERT target
- ERT target for generating and building a Visual C++[®] Solution (.sln) file for the Visual C++ IDE
- ERT target for generating a Windows[®] or UNIX[®] host-based shared library

These targets are based on a common system target file, `ert.tlc`. They are displayed in the System Target File Browser as shown in the figure below.

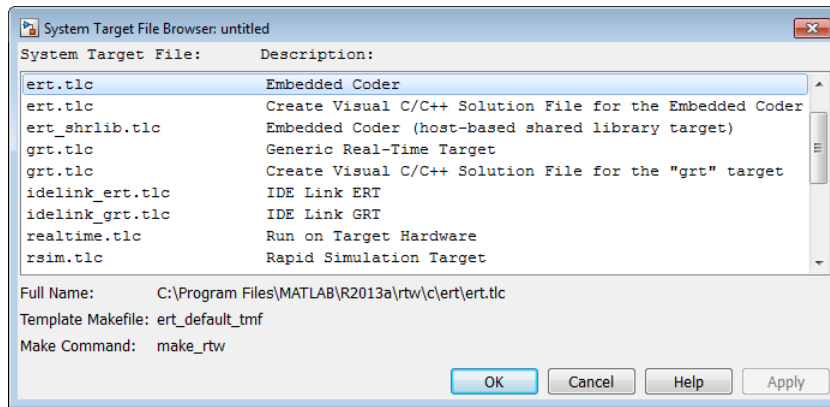

You can use the `ert_shrlib.tlc` target to generate a host-based shared library from your Simulink model. Selecting this target allows you to generate a shared library version of your model code for your host platform, either a Windows dynamic link library (.dll) file or a UNIX shared object (.so) file. This feature can be used to package your source code securely for easy distribution and shared use.

Customize an ERT Target

For information on customizing ERT targets, see “Target Development”.

Configure Support for Numeric Data

By default, ERT targets support code generation for integer, floating-point, nonfinite, and complex numbers.

To Generate Code that Supports...	Do...
Integer data only	Deselect Support floating-point numbers . If noninteger data or expressions are encountered during code generation, an error message reports the offending blocks and parameters.
Floating-point data	Select Support floating-point numbers .

To Generate Code that Supports...	Do...
Nonfinite values (for example, NaN, Inf)	Select Support floating-point numbers and Support non-finite numbers .
Complex data	Select Support complex numbers .

For more information, see “Code Generation Pane: Interface”.

Configure Support for Time Values

Certain blocks require the value of absolute time (that is, the time from the start of program execution to the present time) , elapsed time (for example, the time elapsed between two trigger events), or continuous time. Depending on the blocks used, you might need to adjust the configuration settings for supported time values.

To...	Select...
Generate code that creates and maintains integer counters for blocks that use absolute or elapsed time values (default)	Support absolute time. For further information on the allocation and operation of absolute and elapsed timers, see “Timers”. If you do not select this parameter and the model includes block that use absolute or elapsed time values, the build process generates an error.
Generate code for blocks that rely on continuous time	Support continuous time. If you do not select this parameter and the model includes continuous-time blocks, the build process generates an error.

For more information, see “Code Generation Pane: Interface”.

Support for Non-inlined S-Functions

To generate code for noninlined S-Functions in a model, select **Support noninlined S-functions**. The generation of noninlined S-functions requires floating-point and nonfinite numbers. Thus, when you select **Support non-inlined S-functions**, the ERT target automatically selects **Support floating-point numbers** and **Support non-finite numbers**.

When you select **Support non-finite numbers**, the build process generates an error if the model includes a C MEX S-function that does not have a corresponding TLC implementation (for inlining code generation).

Note that inlining S-functions is highly advantageous in production code generation, for example in implementing device drivers. To enforce the use of inlined S-functions for code generation, deselect **Support non-inlined S-functions**.

For more information, see “Code Generation Pane: Interface”.

Configure Model Function Generation and Argument Passing

For ERT targets, you can configure how a model’s functions are generated and how arguments are passed to the functions.

To...	Do...
Generate model function calls that are compatible with the main program module of the pre-R2012a GRT target (<code>grt_main.c</code> or <code>.cpp</code>)	Select Classic call interface and MAT-file logging . In addition, deselect Suppress error status in real-time model data structure . Classic call interface provides a quick way to use code generated in R2012a or higher with a pre-R2012a GRT-based custom target by generating wrapper function calls that interface to the generated code.
Reduce overhead and use more local variables by combining the output and update functions in a single <code>model_step</code> function	Select Single output/update function . Errors or unexpected behavior can occur if a Model block is part of a cycle and “Single output/update function” is enabled (the default). See “Model Blocks and Direct Feed through” for details.
Generate a <code>model_terminate</code> function for a model not designed to run indefinitely	Select Terminate function required . For more information, see the description of <code>model_terminate</code> .
Generate reusable, reentrant code from a model or subsystem	Select Generate reusable code . See “Set Up Support for Code Reuse” on page 14-29 for details.

To...	Do...
Statically allocate model data structures and access them directly in the model code	Deselect Generate reusable code . The generated code is not reusable or reentrant. See “Entry Point Functions and Scheduling” for information on the calling interface generated for model functions in this case.
Suppress the generation of an error status field in the real-time model data structure, <code>rtModel</code> , for example, if you do not need to log or monitor error messages	<p>Select Suppress error status in real-time model data structure. Selecting this parameter can also cause the <code>rtModel</code> structure to be omitted completely from the generated code.</p> <p>When generating code for multiple integrated models, set this parameter the same for all of the models. Otherwise, the integrated application might exhibit unexpected behavior. For example, if you select the option in one model but not in another, the error status might not be registered by the integrated application.</p> <p>Do not select this parameter if you select the MAT-file logging option. The two options are incompatible.</p>
Open the Model Step Functions dialog box preview and modify the model's <code>model_step</code> function prototype (see “Entry Point Functions and Scheduling”)	Click Configure Step Function . Based on the Function specification value you select for your <code>model_step</code> function (supported values include <code>Default model-step function</code> and <code>Model specific C</code> prototype), you can preview and modify the function prototype. Once you validate and apply your changes, you can generate code based on your function prototype modifications. For more information about using the Configure Step Function button and the Model Step Functions dialog box, see “Function Prototype Control” on page 12-2.

For more information, see “Code Generation Pane: Interface”.

Set Up Support for Code Reuse

For ERT targets, you can configure how a model reuses code using the **Generate reusable code** parameter.

Pass root-level I/O as provides options that control how model inputs and outputs at the root level of the model are passed to the `model_step` function.

To...	Select...
Pass each root-level model input and output argument to the <code>model_step</code> function individually (the default)	Generate reusable code and Pass root-level I/O as > Individual arguments.
Pack root-level input arguments and root-level output arguments into separate structures that are then passed to the <code>model_step</code> function	Generate reusable code and Pass root-level I/O as > Structure reference

In some cases, selecting **Generate reusable code** can generate code that compiles but is not reentrant. For example, if a signal, DWork structure, or parameter data has a storage class other than Auto, global data structures are generated. To handle such cases, use the **Reusable code error diagnostic** parameter to choose the severity levels for diagnostics.

In some cases, the Embedded Coder software is unable to generate valid and compilable code. For example, if the model contains one of the following, the code generated would be invalid.

- An S-function that is not code-reuse compliant
- A subsystem triggered by a wide function call trigger

In these cases, the build terminates after reporting the problem.

For more information, see “Code Generation Pane: Interface”.

Configure Code Replacement Libraries

A *code replacement library* (CRL) is a set of one or more code replacement tables that define the target-specific implementations of math functions and operators to be used in generating code for your Simulink model. The Simulink Coder product provides default CRLs, which you can select from the **Code replacement library** drop-down list on the **Interface** pane of the Configuration Parameters dialog box.

CRL tables provide the basis for replacing default math functions and operators in your model code with target-specific code. If you select a library and then hover over the selected library with the cursor, a tool tip is displayed that describes the CRL and lists the code replacement tables it contains. Tables are listed in the order in which they are searched for a function or operator match.

The Simulink Coder product allows you to view the content of CRL code replacement tables using the Code Replacement Viewer, as described in “Selecting and Viewing Code Replacement Libraries”. The Embedded Coder product allows you to additionally create and register the code replacement tables that make up a CRL, as described in “Code Replacement”.

Configuration Variations

About Model Configuration for Code Generation

This chapter explains how to use the Embedded Real-Time (ERT) target code generation options to configure models for production code generation. The discussion also includes other options that are not specific to the ERT target, but concern ERT code generation.

Every model contains one or more named configuration sets that specify model parameters such as solver options, code generation options, and other choices. A model can contain multiple configuration sets, but only one configuration set is active at a time. A configuration set includes options that specify code generation in general, and options that are specific to a given target, such as the ERT target.

Configuration sets can be particularly useful in embedded systems development. By defining multiple configuration sets in a model, you can easily retarget code generation from that model. For example, one configuration set might specify the default ERT target with external mode support enabled for rapid prototyping, while another configuration set might specify the ERT-based target for Visual C++ to generate production code for deployment of the application. Activation of either configuration set fully reconfigures the model for that type of code generation.

Before you work with the ERT target options, you should become familiar with

- Configuration sets and how to view and edit them in the Configuration Parameters dialog box. For more information, see “About Model Configurations”.
- Code generation options and the use of the System Target File Browser. For more information, see “Configure a Model for Code Generation”.

Wizard

In this section...
“Block Library” on page 14-33
“Add a Configuration Wizard Block” on page 14-35
“Use Configuration Wizard Blocks” on page 14-37
“Create a Custom Configuration Wizard Block” on page 14-37

Block Library

The Embedded Coder software provides a library of *Configuration Wizard* blocks and scripts to help you configure and optimize code generation from your models quickly and easily.

The library provides a Configuration Wizard block you can customize, and four preset Configuration Wizard blocks.

Block	Description
Custom MATLAB file	Automatically update active configuration parameters of parent model using a custom file
ERT (optimized for fixed-point)	Automatically update active configuration parameters of parent model for ERT fixed-point code generation
ERT (optimized for floating-point)	Automatically update active configuration parameters of parent model for ERT floating-point code generation

Block	Description
GRT (debug for fixed/floating-point)	Automatically update active configuration parameters of parent model for GRT fixed- or floating-point code generation with debugging enabled
GRT (optimized for fixed/floating-point)	Automatically update active configuration parameters of parent model for GRT fixed- or floating-point code generation

These are shown in the figure below.

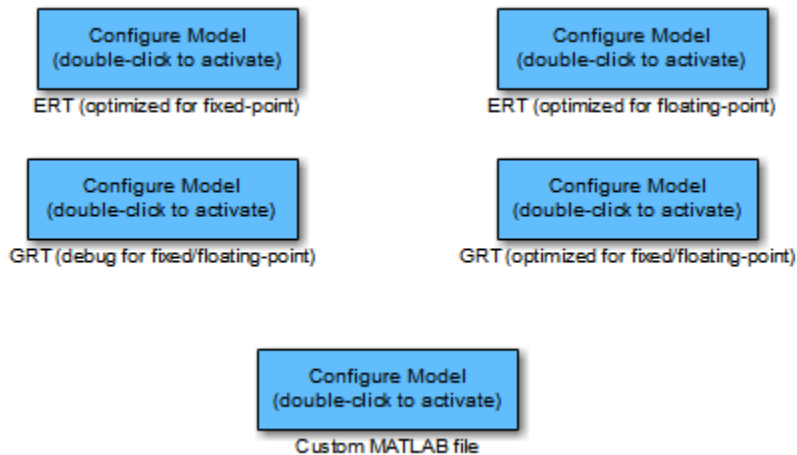

When you add one of the preset Configuration Wizard blocks to your model and double-click it, a predefined MATLAB file script executes and configures parameters of the model's active configuration set without manual intervention. The preset blocks configure the options optimally for one of the following cases:

- Fixed-point code generation with the ERT target
- Floating-point code generation with the ERT target

- Fixed/floating-point code generation with TLC debugging options enabled, with the GRT target.
- Fixed/floating-point code generation with the GRT target

The Custom block is associated with an example MATLAB file script that you can adapt to your requirements.

You can also set up the Configuration Wizard blocks to invoke the build process after configuring the model.

Add a Configuration Wizard Block

This section describes how to add one of the preset Configuration Wizard blocks to a model.

The Configuration Wizard blocks are available in the Embedded Coder block library. To use a Configuration Wizard block:

- 1 Open the model that you want to configure.
- 2 Open the Embedded Coder library by typing the command `rtweclib`.
- 3 The top level of the library is shown below.

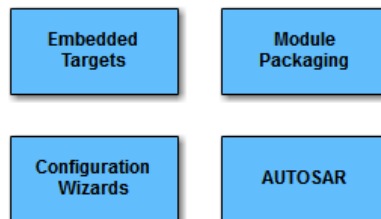

- 4 Double-click the Configuration Wizards icon. The Configuration Wizards sublibrary opens.

- 5 Select the Configuration Wizard block you want to use and drag and drop it into your model. In the figure below, the ERT (optimized for fixed-point) Configuration Wizard block has been added to the model.

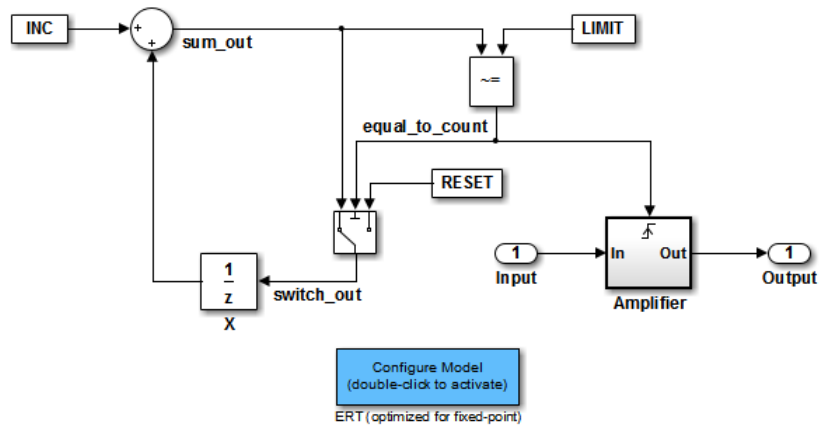

- 6 You can set up the Configuration Wizard block to invoke the build process after executing its configuration script. If you do not want to use this feature, skip to the next step.

If you want the Configuration Wizard block to invoke the build process, right-click on the Configuration Wizard block in your model, and select **Mask > Mask Parameters...** from the context menu. Then, select the **Invoke build process after configuration** parameter.

- 7 Click **Apply**, and close the Mask Parameters dialog box.

Note You should not change the **Configure the model for** option, unless you want to create a custom block and script. In that case, see “Create a Custom Configuration Wizard Block” on page 14-37.

- 8 Save the model.
- 9 You can now use the Configuration Wizard block to configure the model, as described in the next section.

Use Configuration Wizard Blocks

Once you have added a Configuration Wizard block to your model, just double-click the block. The script associated with the block automatically sets parameters of the active configuration set that are relevant to code generation (including selection of the target). You can verify that the options have changed by opening the Configuration Parameters dialog box and examining the settings.

If the **Invoke build process after configuration** option for the block was selected, the script also initiates the code generation and build process.

Note You can add more than one Configuration Wizard block to your model. This provides a quick way to switch between configurations.

Create a Custom Configuration Wizard Block

The Custom Configuration Wizard block is shipped with an associated MATLAB file script, `rtwsampleconfig.m`. The script is located in the folder `matlabroot/toolbox/rtw/rtw`.

Both the block and the script are intended to provide a starting point for customization. This section describes:

- How to create a custom Configuration Wizard block linked to a custom script.
- Operation of the example script, and programming conventions and requirements for a customized script.
- How to run a configuration script from the MATLAB command line (without a block).

Setting Up a Configuration Wizard Block

This section describes how to set up a custom Configuration Wizard block and link it to a script. If you want to use the block in more than one mode, it is advisable to create a Simulink library to contain the block.

To begin, make a copy of the example script for later customization:

- 1 Create a folder to store your custom script. This folder should not be anywhere inside the MATLAB folder structure (that is, it should not be under *matlabroot*).

The discussion below refers to this folder as */my_wizards*.

- 2 Add the folder to the MATLAB path. Save the path for future sessions.
- 3 Copy the example script (*matlabroot/toolbox/rtw/rtw/rtwsampleconfig.m*) to the */my_wizards* folder you created in the previous steps. Then, rename the script as desired. The discussion below uses the name *my_configscript.m*.
- 4 Open the example script into the MATLAB editor. Scroll to the end of the file and enter the following line of code:

```
disp('Custom Configuration Wizard Script completed.');
```

This statement is used later as a test to verify that your custom block has executed the script.

- 5 Save your script and close the MATLAB editor.

The next step is to create a Simulink library and add a custom block to it. Do this as follows:

- 1 Open the Embedded Coder library and the Configuration Wizards sublibrary, as described in “Add a Configuration Wizard Block” on page 14-35.
- 2 Select **New > Library** from the **File** menu of the Configuration Wizards sublibrary window. An empty library window opens.
- 3 Select the Custom MATLAB file block from the Configuration Wizards sublibrary and drag and drop it into the empty library window.
- 4 To distinguish your custom block from the original, edit the Custom MATLAB file label under the block as desired.
- 5 Select **Save as** from the **File** menu of the new library window; save the library to the */my_wizards* folder, under your library name of choice. In

the figure below, the library has been saved as `ex_custom_button`, and the block has been labeled `my_wizard` MATLAB-file.

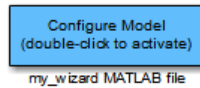

The next step is to link the custom block to the custom script:

- 1 Right-click on the block in your model, and select **Mask > Mask Parameters** from the context menu. Notice that the **Configure the model for** menu is set to **Custom**. When **Custom** is selected, the **Configuration function** edit field is enabled, so that you can enter the name of a custom script.
- 2 Enter the name of your custom script into the **Configuration function** field. (Do not enter the `.m` filename extension, which is implicit.) In the figure below, the script name `my_configscript` has been entered into the **Configuration function** field. This establishes the linkage between the block and script.

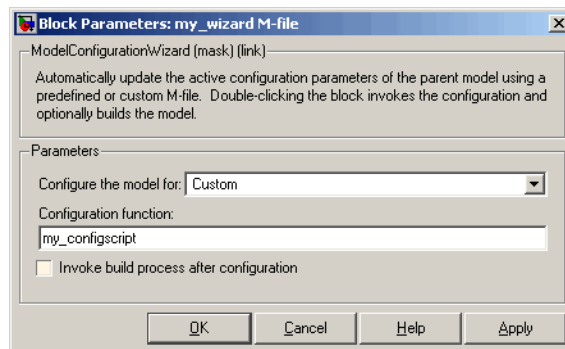

- 3 Note that by default, the **Invoke build process after configuration** option is deselected. You can change the default for your custom block by selecting this option. For now, leave this option deselected.
- 4 Click **Apply** and close the Mask Parameters dialog box.
- 5 Save the library.

- 6 Close the Embedded Coder library and the Configuration Wizards sublibrary. Leave your custom library open for use in the next step.

Now, test your block and script in a model. Do this as follows:

- 1 Open the vdp model by typing the command:

```
vdp
```

- 2 Open the Configuration Parameters dialog box and view the options by clicking on **Code Generation** in the list in the left pane of the dialog box.
- 3 Observe that vdp is configured, by default, for the GRT target. Close the Configuration Parameters dialog box.
- 4 Select your custom block from your custom library. Drag and drop the block into the vdp model.
- 5 In the vdp model, double-click your custom block.
- 6 In the MATLAB window, you should see the test message you previously added to your script:

```
Custom Configuration Wizard Script completed.
```

This indicates that the custom block executed the script.

- 7 Reopen the Configuration Parameters dialog box and view the **Code Generation** pane again. You should now see that the model is configured for the ERT target.

Before applying further edits to your custom script, proceed to the next section to learn about the operation and conventions of Configuration Wizard scripts.

Create a Configuration Wizard Script

You should create your custom Configuration Wizard script by copying and modifying the example script, `rtwsampleconfig.m`. This section provides guidelines for modification.

The Configuration Function. The example script implements a single function without a return value. The function takes a single argument `cs`:

```
function rtwsampleconfig(cs)
```

The argument `cs` is a handle to a proprietary object that contains information about the model's active configuration set. The Simulink software obtains this handle and passes it in to the configuration function when the user double-clicks a Configuration Wizard block.

Your custom script should conform to this prototype. Your code should use `cs` as a “black box” object that transmits information to and from the active configuration set, using the accessor functions described below.

Access Configuration Set Parameters. To set parameters or obtain parameter values, use the Simulink `set_param` and `get_param` functions.

Option names are passed in to `set_param` and `get_param` as strings specifying an *internal option name*. The internal option name may not correspond to the option label on the GUI (for example, the Configuration Parameters dialog box). The example configuration accompanies each `set_param` and `get_param` call with a comment that correlates internal option names to GUI option labels. For example:

```
set_param(cs,'LifeSpan','1'); % Application lifespan (days)
```

To obtain the current setting of an option in the active configuration set, call `get_param`. Pass in the `cs` object as the first argument, followed by the internal option name. For example, the following code excerpt tests the setting of the **Create code generation report** option:

```
if strcmp(get_param(cs, 'GenerateReport'), 'on')
    ...
```

To set an option in the active configuration set, call `set_param`. Pass in the `cs` object as the first argument, followed by one or more parameter/value

pairs that specify the internal option name and its value. For example, the following code excerpt turns off the **Support absolute time** option:

```
set_param(cs, 'SupportAbsoluteTime', 'off');
```

Select a Target. A Configuration Wizard script must select a target configuration. The example script uses the ERT target as a default. The script first stores string variables that correspond to the required **System target file**, **Template makefile**, and **Make command** settings:

```
stf = 'ert.tlc';  
tmf = 'ert_default_tmf';  
mc = 'make_rtw';
```

The system target file is selected by passing the `cs` object and the `stf` string to the `switchTarget` function:

```
switchTarget(cs, stf, []);
```

The template makefile and make command options are set by `set_param` calls:

```
set_param(cs, 'TemplateMakefile', tmf);  
set_param(cs, 'MakeCommand', mc);
```

To select a target, your custom script needs only to set up the string variables `stf`, `tmf`, and `mc` and pass them to the calls, as above.

Obtain Target and Configuration Set Information. The following utility functions and properties are provided so that your code can obtain information about the current target and configuration set, with the `cs` object:

- `isValidParam(cs, 'option')`: The option argument is an internal option name. `isValidParam` returns true if option is a valid option in the context of the active configuration set.
- `getPropEnabled(cs, 'option')`: The option argument is an internal option name. Returns true if this option is enabled (that is, writable).
- `IsERTTarget` property: Your code can detect whether or not the currently selected target is derived from the ERT target is selected by checking the `IsERTTarget` property, as follows:

```
isERT = strcmp(get_param(cs, 'IsERTTarget'), 'on');
```

This information can be used to determine whether or not the script should configure ERT-specific options, for example:

```
if isERT
    set_param(cs, 'ZeroExternalMemoryAtStartup', 'off');
    set_param(cs, 'ZeroInternalMemoryAtStartup', 'off');
    set_param(cs, 'InitFltsAndDblsToZero', 'off');
    set_param(cs, 'InlinedParameterPlacement', ...
              'NonHierarchical');
    set_param(cs, 'NoFixptDivByZeroProtection', 'on')
end
```

Invoke a Configuration Wizard Script from the MATLAB Command Prompt

Configuration Wizard scripts can be run from the MATLAB command prompt. (The Configuration Wizard blocks are provided as a graphical convenience, but are not essential.)

Before invoking the script, you must open a model and instantiate a `cs` object to pass in as an argument to the script. After running the script, you can invoke the build process with the `rtwbuild` command. The following example opens, configures, and builds a model.

```
open my_model;
cs = getActiveConfigSet ('my_model');
rtwsampleconfig(cs);
rtwbuild('my_model');
```

Code Appearance

- “Add Custom Comments to Generated Code” on page 15-2
- “Add Custom Comments for Signal or Parameter Identifiers” on page 15-4
- “Add Global Comments” on page 15-6
- “Customize Generated Identifier Naming Rules” on page 15-12
- “Identifier Format Control” on page 15-14
- “Control Name Mangling in Generated Identifiers” on page 15-18
- “Avoid Identifier Name Collisions with Referenced Models” on page 15-20
- “Maintain Traceability for Generated Identifiers” on page 15-21
- “Exceptions to Identifier Formatting Conventions” on page 15-22
- “Identifier Format Control Parameters Limitations” on page 15-23
- “Specify Simulink Data Object Naming Rules” on page 15-25
- “Control Code Style” on page 15-26
- “Customize Code Organization and Format” on page 15-28
- “Code Annotation for Justifying Polyspace Checks” on page 15-72
- “Manage Placement of Data Definitions and Declarations” on page 15-74
- “Specify Delimiter for #Includes” on page 15-101

Add Custom Comments to Generated Code

You can include auto-generated comments in the generated code as described in “Configure Code Comments”. For ERT targets, include additional custom comments by setting parameters on the **Code Generation > Comments** pane of the Configuration Parameters dialog box. With these parameters, you can enable or suppress generation of descriptive information in comments for blocks and other model elements.

To...	Select...
Include the text specified in the Description field of a block’s Block Properties dialog box as comments in the code generated for each block	Simulink block descriptions.
Add a comment that includes the block name at the start of the code for each block	Simulink block descriptions
Include the text specified in the Description field of a Simulink data object (such as a signal, parameter, data type, or bus) in the Simulink Model Explorer as comments in the code generated for each object	Simulink data object descriptions.
Include comments just above signals and parameter identifiers in the generated code as specified in the MATLAB or TLC function.	Custom comments (MPT objects only).
Include the text specified in the Description field of the Properties dialog box for a Stateflow object as comments just above the code generated for each object	Stateflow object descriptions .
Include requirements assigned to Simulink blocks in the generated code comments (for more information, see “Generate Code for Models with Requirements Links”)	Requirements in block comments.

When you select **Simulink block descriptions**,

- The description text for blocks and Stateflow objects and block names generated as comments can include international (non-US-ASCII)

characters. For details on international character support, see “Support for International (Non-US-ASCII) Characters”.

- The code generation software automatically inserts comments into the generated code for custom blocks. Therefore, it is not required to include block comments in the associated TLC file for a custom block.

Note If you have existing TLC files with manually inserted comments for block descriptions, the code generation process emits these comments instead of the automatically generated comments. Consider removing existing block comments from your TLC files. Manually inserted comments might be poorly formatted in the generated code and code-to-model traceability might not work.

- For virtual blocks or blocks that have been removed due to block reduction, comments are not generated.

For more information, see “Code Generation Pane: Comments”.

Add Custom Comments for Signal or Parameter Identifiers

This example shows you how to add a comment just above a signal or parameter's identifier in the generated code. This is accomplished using

- A MATLAB or TLC function that you write and save in a .m or .t1c file
- The **Custom comments (MPT objects only)** check box on the **Code Generation > Comments** pane of the Configuration Parameters dialog box
- Selecting the .m or .t1c file in the **Custom comments function** field on the **Code Generation > Comments** pane of the Configuration Parameters dialog box.

You may include at least some or all of the property values for the data object. Each Simulink data object (signal or parameter) has properties, as described in Parameter and Signal Property Values on page 9-3. This example comment contains some of the property values for the data object MAP as specified on the Model Explorer:

```
/*      DocUnits:          PSI                                */
/*      Owner:            */
/*      DefinitionFile: specialDef                          */
real_T MAP = 0.0;
```

You can type text in the **Description** field on the Model Explorer for a signal or parameter data object. If you do, and if you select the **Simulink data object descriptions** check box on the **Comments** pane of the Configuration Parameters dialog box, this text will appear beside the signal's or parameter's identifier in the generated code as a comment. This is true whether or not you select the **Custom comments (MPT objects only)** check box discussed in this procedure. For example, typing Manifold Absolute Pressure in the **Description** field for the data object MAP results in the following in the generated code:

```
real_T MAP = 0.0;      /* Manifold Absolute Pressure */
```

To add a comment just above a signal or parameter's identifier in the generated code:

- 1** The signal or parameter MPT object must use a custom storage class. Open the MPT object properties dialog box and confirm that the **Storage class** is a custom storage class ((Custom) suffixed to its name). The default storage class for an MPT object is Global (Custom).
- 2** Write a MATLAB or TLC function that places comments in the generated files as desired. An example .m file named `rtwdemo_comments_mptfun.m` is provided in the `matlab/toolbox/rtw/rtwdemos` folder. This file contains instructions.

The MATLAB function must have three arguments that correspond to `objectName`, `modelName`, and `request`, respectively. The TLC function must have three arguments that correspond to `objectName`, `modelName`, and `request`, respectively. Note also, in the case of the TLC file, you can use the library function `LibGetSLDataObjectInfo` to get every property value of the data object.

- 3** Save the function as a .m file or a .tlc file and place it in a folder in the MATLAB path.
- 4** Open the model and the Configuration Parameters dialog box.
- 5** Click **Comments** under **Code Generation** on the left pane. The **Comments** pane appears on the right.
- 6** Select the **Custom comments (MPT objects only)** check box.
- 7** In the **Custom comments function** field, type the filename of the .m file or .tlc file you created.
- 8** Click the **Apply** button.
- 9** Click **Generate Code**.
- 10** Open the generated files and inspect their content to check that the comments are what you want.

Add Global Comments

In this section...

“Use a Simulink DocBlock to Add a Comment” on page 15-6

“Use a Simulink Annotation to Add a Comment” on page 15-9

“Use a Stateflow Note to Add a Comment” on page 15-9

“Use Sorted Notes to Add Comments” on page 15-10

The following examples show how to add a global comment to a Simulink model so that the comment text appears in the generated file or files where desired. This is accomplished by specifying a template symbol name with a Simulink DocBlock, a Simulink annotation, or a Stateflow note, or by using a sorted-notes capability that works with Simulink annotations or Stateflow notes (but not DocBlocks). For more information about template symbols, see “Template Symbols and Rules” on page 15-63.

Note Template symbol names `Description` and `ModifiedHistory`, referenced below, also are fields in the Model Properties dialog box. If you use one of these symbol names for global comment text, and its Model Properties field has text in it too, both will appear in the generated files.

Use a Simulink DocBlock to Add a Comment

- 1 With the model open, select **Library Browser** from the **View** menu.
- 2 Drag the DocBlock from **Model-Wide Utilities** in the Simulink library onto the model.
- 3 After double-clicking the DocBlock and typing the desired comment in the editor, save and close the editor.
- 4 Right-click the DocBlock and select **Mask Parameters**. The Block Parameters dialog box appears.
- 5 Type one of the following into the **Code generation template symbol** field, illustrated below, and then click **OK**: `Abstract`, `Description`,

History, ModifiedHistory, or Notes. Template symbol names are case sensitive.

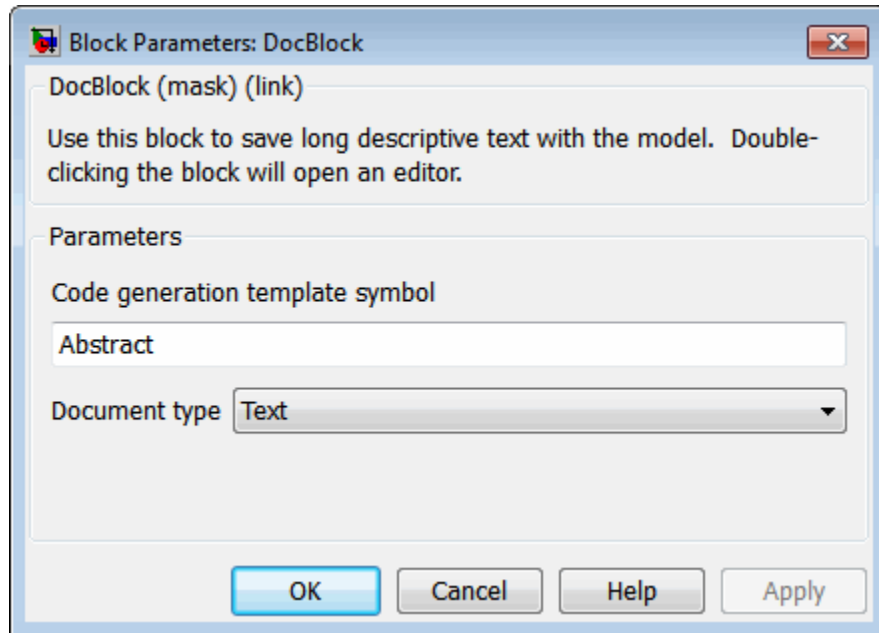

Note If you are using a DocBlock to add comments to your code during code generation, set the **Document Type** as **Text**. If you set the **Document Type** as **RTF** or **HTML**, your comments will not appear in the code.

- 6 In the Block Properties dialog box, **Block Annotation** tab, select %<ECoderFlag> as shown in the figure below, and then click **OK**. The symbol name typed in the previous step now appears under the DocBlock on the model.

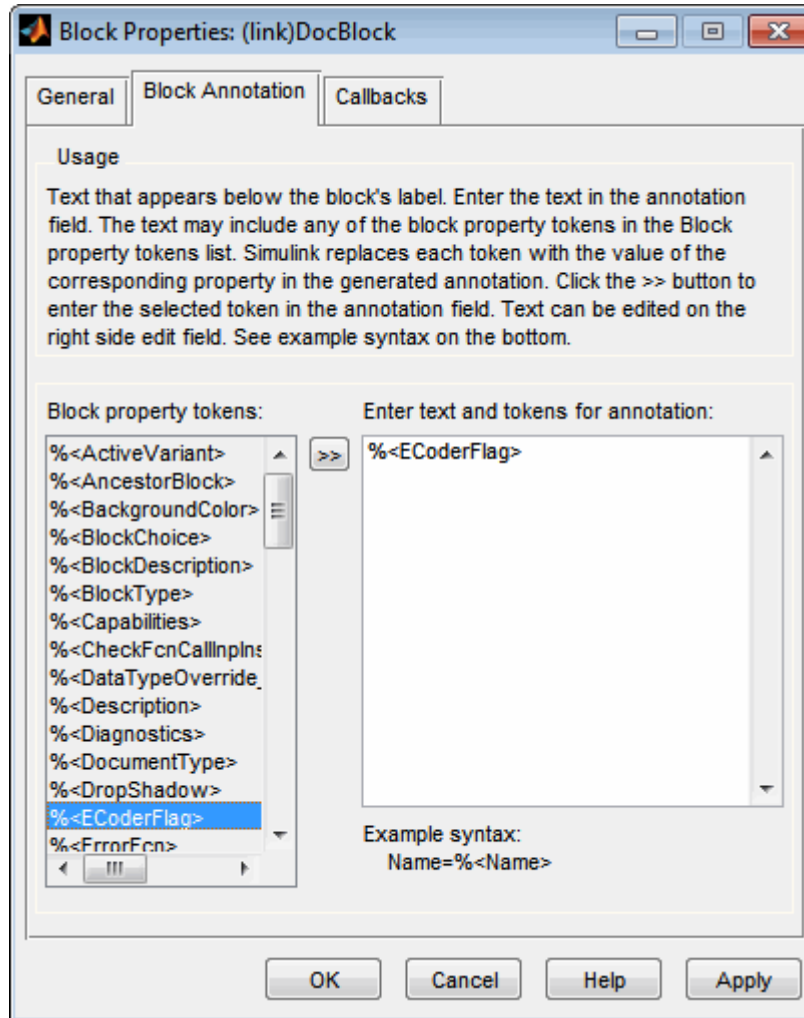

- 7 Save the model. After you generate code, the code generator places the comment in each generated file whose template has the symbol name you typed. The code generator places the comment in the generated file at the location that corresponds to where the symbol name is located in the template file.

- 8 To add one or more other comments to the generated files, repeat steps 1 through 7 as desired.

Use a Simulink Annotation to Add a Comment

- 1 Double-click the unoccupied area on the model where you want to place the comment. See “Annotate Diagrams” for details.

Note If you want the code generator to sort multiple comments for the Notes symbol name, replace the next step with “Use Sorted Notes to Add Comments” on page 15-10.

- 2 Type <S:Symbol_name> followed by the comment, where Symbol_name is one of the following Documentation child : Abstract, Description, History, ModifiedHistory, or Notes. For example, type <S:Description>This is the description I want. Template symbol names are case sensitive. (The "S" before the colon indicates "symbol.")
- 3 Click outside the rectangle and save the model. After you generate code, the code generator places the comment in each generated file whose template has the symbol name you typed. The code generator places the comment in the generated file at the location that corresponds to where the symbol name is located in the template file.
- 4 To add one or more other comments to the generated files, repeat steps 1 through 3 as desired.

Use a Stateflow Note to Add a Comment

- 1 Right-click the desired unoccupied area on the Stateflow chart where you want to place the comment. For more information, see “Add Descriptive Comments in a Chart”.
- 2 Select the annotation icon from the palette.

Note If you want the code generator to sort multiple comments for the `Notes` symbol name, replace the next step with “Use Sorted Notes to Add Comments” on page 15-10.

- 3** Type `<S:Symbol_name>` followed by the comment, where `Symbol_name` is one of the following Documentation child : `Abstract`, `Description`, `History`, `ModifiedHistory`, or `Notes`. For example, type `<S:Description>This is the description I want`. Template symbol names are case sensitive.
- 4** Click outside the note and save the model. After you generate code, the code generator places the comment in each generated file whose template has the symbol name you typed. The code generator places the comment in the generated file at the location that corresponds to where the symbol name is located in the template file.
- 5** To add one or more other comments to the generated files, repeat steps 1 through 4 as desired.

Use Sorted Notes to Add Comments

The sorted-notes capability allows you to add automatically sorted comments to the generated files. The code generator places these comments in each generated file at the location that corresponds to where the `Notes` symbol is located in the template file.

The sorting order the code generator uses is

- Numbers before letters
- Among numbers, 0 is first
- Among letters, uppercase are before lowercase.

You can use sorted notes with a Simulink annotation or a Stateflow note, but not with a DocBlock:

- In the Simulink annotation or the Stateflow note, type `<S:NoteY>` followed by the first comment, where `Y` is a number or letter.

- Repeat for as many additional comments you want, except replace Y with a subsequent number or letter.

The figure below illustrates sorted notes on a model, and where the code generator places each in a generated file.

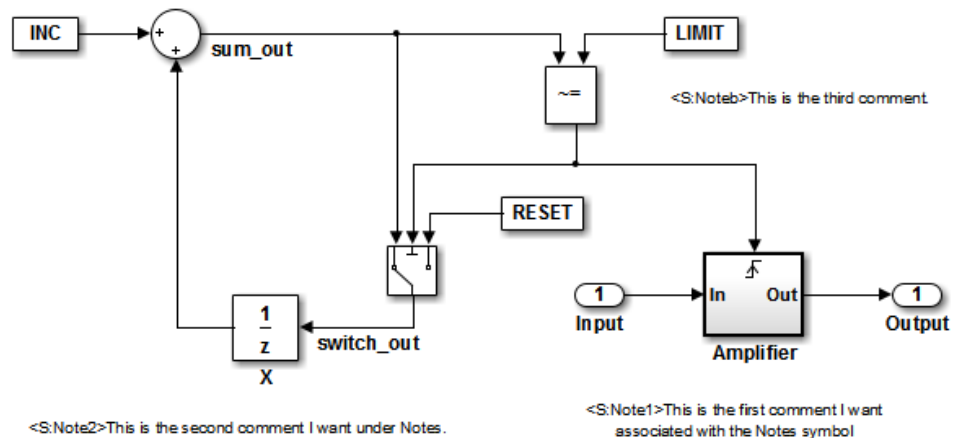

Here is the relevant fragment from the generated file for the above model:

```
** NOTES
```

```
** Note1: This is the first comment I want
associated with the Notes symbol.
```

```
Note2: This is the second comment I want under Notes.
```

```
Noteb: This is the third comment.
```

```
**
```

Customize Generated Identifier Naming Rules

For GRT and RSim targets, the code generator automatically constructs identifiers for variables and functions in the generated code. For ERT targets, you can customize the naming of identifiers in the generated code by specifying parameters on the **Code Generation > Symbols** pane of the Configuration Parameters dialog box.

To...	Specify...
Set the maximum number of characters the code generator can use for function, typedef, and variable names (default 31)	An integer value for the “Maximum identifier length” parameter. For more information, see “Specify Identifier Length to Avoid Naming Collisions”. If you expect your model to generate lengthy identifiers (due to use of long signal or parameter names, for example), or you find that identifiers are being mangled more than expected, you should increase the value of this parameter. For more information, see “Specify Identifier Length to Avoid Naming Collisions”.
Define a macro string that specifies certain substrings that are included within generated identifiers for global variables, global types, field names of global types, subsystem methods, subsystem method arguments, local temporary variables, local block output variables, and constant macros	A macro string for the Identifier format control parameters. For more information, see “Identifier Format Control” on page 15-14. For exceptions and limitations, see “Exceptions to Identifier Formatting Conventions” on page 15-22 and “Identifier Format Control Parameters Limitations” on page 15-23.
Set the minimum number of characters that the code generator uses for the mangling string	An integer value for the “Minimum mangle length” parameter. For more information, see “Control Name Mangling in Generated Identifiers” on page 15-18.

To...	Specify...
Control whether shortened names are used for system-generated identifiers	Shortened for the “System-generated identifiers” parameter. This setting provides more space for user names, a more predictable and consistent naming system that uses camel case, no underscores or plurals, and consistent abbreviations for both a type and a variable.
Control whether scalar inlined parameter values are expressed in the generated code as literal values or macros	The value <code>Literals</code> or <code>Macros</code> for the “Generate scalar inlined parameter as” parameter. <ul style="list-style-type: none">• Literals: If Inline parameters is selected, parameters are expressed as numeric constants.• Macros: Parameters are expressed as variables (with <code>#define</code> macros). This setting makes code more readable.

For more information on these parameters, see “Code Generation Pane: Symbols”.

Identifier Format Control

You can customize generated identifiers by specifying the **Identifier format control** parameters on the **Code Generation > Symbols** pane of the Configuration Parameters dialog box. For each parameter, you can enter a macro string that specifies whether, and in what order, certain substrings are included within generated identifiers. For example, you can specify that the root model name be inserted into each identifier using the \$R token.

The macro string can include:

- Valid tokens, which are listed in Identifier Format Tokens on page 15-14. You can use or omit tokens depending on what you want to include in the identifier name. The mangling string token, \$M, is required. For more information, see “Control Name Mangling in Generated Identifiers” on page 15-18. The mangling string token is subject to the use and ordering restrictions noted in Identifier Format Control Parameter Values on page 15-16.
- Valid C or C++ language identifier characters (a-z, A-Z, _ , 0-9).

The build process generates each identifier by expanding tokens and inserting the resultant strings into the identifier. The tokens are expanded in the order listed in Identifier Format Tokens on page 15-14. Character strings are inserted between tokens, directly into the identifier. Contiguous token expansions are separated by the underscore (_) character.

Identifier Format Tokens

Token	Description
\$M	This token is required. If necessary, the code generator inserts a name mangling string to avoid naming collisions. The position of the \$M token in the Identifier format control parameter specification determines the position of the name mangling string in the generated identifiers. For example, if you use the specification \$R\$N\$M, the name mangling string is appended (if required) to the end of the identifier. For more information,

Identifier Format Tokens (Continued)

Token	Description
	see “Control Name Mangling in Generated Identifiers” on page 15-18
\$F	Insert method name (for example, <code>_Update</code> for update method). This token is available only for subsystem methods.
\$N	Insert name of object (block, signal or signal object, state, parameter or parameter object) for which identifier is being generated.
\$R	Insert root model name into identifier, replacing unsupported characters with the underscore (<code>_</code>) character. When you use referenced models, this token is required in addition to \$M (see “Avoid Identifier Name Collisions with Referenced Models” on page 15-20). Note: This token replaces the Prefix model name to global identifiers option in previous releases.
\$H	Insert tag indicating system hierarchy level. For root-level blocks, the tag is the string <code>root_</code> . For blocks at the subsystem level, the tag is of the form <code>sN_</code> . N is a unique system number assigned by the Simulink software. This token is available only for subsystem methods and field names of global types. Note: This token replaces the Include System Hierarchy Number in Identifiers option in previous releases.
\$A	Insert data type acronym (for example, <code>i32</code> for long integers) to signal and work vector identifiers. This token is available only for local block output variables and field names of global types. Note: This token replaces the Include data type acronym in identifier option in previous releases.
\$I	Insert <code>u</code> if the argument is an input or <code>y</code> if the argument is an output, (for example, <code>rtu_</code> for an input argument and <code>rtu_</code> for an output argument). This token is available only for subsystem method arguments.

Identifier Format Control Parameter Values on page 15-16 lists the default macro string, the supported tokens, and the applicable restrictions for each **Identifier format control** parameter.

Identifier Format Control Parameter Values

Parameter	Default Value	Supported Tokens	Restrictions
Global variables	rt\$N\$M	\$R, \$N, \$M	\$F, \$H, \$A, and \$I are not allowed.
Global types	\$N\$R\$M_T	\$N, \$R, \$M	\$F, \$H, \$A, and \$I are not allowed.
Field name of global types	\$N\$M	\$N, \$M, \$H, \$A	\$R, \$F, and \$I are not allowed.
Subsystem methods	\$F\$N\$M	\$R, \$N, \$M, \$F, \$H	\$F and \$H are empty for Stateflow functions; \$A and \$I are not allowed.
Subsystem method arguments	rt\$I\$N\$M or rt\$I\$N\$M	\$N, \$M, \$I	\$R, \$F, \$H, and \$A are not allowed.
Local temporary variables	\$N\$M	\$N, \$M, \$R	\$F, \$H, \$A, and \$I are not allowed.
Local block output variables	rtb_ \$N\$M	\$N, \$M, \$A	\$R, \$F, \$H, and \$I are not allowed.
Constant macros	\$R\$N\$M	\$R, \$N, \$M	\$F, \$H, \$A, and \$I are not allowed.

Non-ERT based targets (such as the GRT target) implicitly use a default \$R\$N\$M specification. This default specification consists of the root model name, followed by the name of the generating object (signal, parameter, state, and so on), followed by a name mangling string.

For limitations that apply to **Identifier format control** parameters, see “Exceptions to Identifier Formatting Conventions” on page 15-22 and “Identifier Format Control Parameters Limitations” on page 15-23.

Control Name Mangling in Generated Identifiers

The position of the \$M token in the **Identifier format control** parameter specification determines the position of the name mangling string in the generated identifiers. For example, if you use the specification \$R\$N\$M, the name mangling string is appended (if required) to the end of the identifier. For more information, see “Identifier Format Control” on page 15-14.

Name Mangling String Per Object

Object Type	Source of Mangling String
Block diagram	Name of block diagram
Simulink block	“Simulink Identifier” (SID)
Simulink parameter	Full name of parameter owner (that is, model or block) and parameter name
Simulink signal	Signal name, full name of source block, and port number
Stateflow objects	Complete path to Stateflow block and Stateflow computed name (unique within chart)

The length of the name mangling string is specified by the **Minimum mangle length** parameter. The default value is 1, but this automatically increases during code generation as a function of the number of collisions. To minimize disturbance to the generated code during development, specify a larger **Minimum mangle length**. A **Minimum mangle length** of 4 is a conservative value. A value of 4 allows for over 1.5 million collisions for a particular identifier before the mangle length is increased.

Minimize Name Mangling

The length of generated identifiers is limited by the **Maximum identifier length** parameter. When a name collision exists, the \$M token is expanded to the minimum number of characters required to avoid the collision. Other tokens and character strings are expanded in the order listed in Identifier Format Tokens on page 15-14. If the **Maximum identifier length** is not large enough to accommodate full expansions of the other tokens, partial expansions are used. To avoid this outcome, it is good practice to:

- Avoid name collisions in general. One way to avoid name collisions is to not use default block names (for example, `Gain1`, `Gain2...`) when there are many blocks of the same type in the model.
- Where possible, increase the **Maximum identifier length** to accommodate the length of the identifiers that you expect to generate.
- Set the **Minimum mangle length** parameter to reserve at least three characters for the name mangling string. The length of the name mangling string increases as the number of name collisions increases.

If changes to the model create more (or fewer) collisions, an existing name mangling string increases (or decreases) in length. If the length of the name mangling string increases, additional characters are appended to the existing string. For example, the mangling string `'xyz'` can change to `'xyzQ'`. For fewer collisions, the name mangling string `'xyz'` changes to `'xy'`.

Avoid Identifier Name Collisions with Referenced Models

Within a model that uses referenced models, collisions between the names of the models is not allowed. When generating code from a model that uses model referencing:

- You must include the **\$R** token in the **Identifier format control** parameter specifications (in addition to the **\$M** token).
- The **Maximum identifier length** must be large enough to accommodate full expansions of the **\$R** and **\$M** tokens. If **Maximum identifier length** is too small, a code generation error occurs.

When a name conflict occurs between an identifier within the scope of a higher-level model and an identifier within the scope of a referenced model, the identifier from the referenced model is preserved. Name mangling is performed on the identifier from the higher-level model.

If your model contains two referenced models with the same input or output port names, and one of the referenced models contains an atomic subsystem with “Function packaging” set to `Nonreusable function`, a name conflict might occur and the build process produces an error.

Maintain Traceability for Generated Identifiers

To verify your model, you can trace back and forth between generated identifiers and corresponding entities within the model. To maintain traceability, it is important that incremental revisions to a model have minimal impact on the identifier names that appear in generated code. There are two ways to minimally impact the identifier names:

- Choose unique names for Simulink objects (blocks, signals, states, and so on) as much as possible.
- Use name mangling when conflicts cannot be avoided.

The position of the name mangling string is specified by the placement of the **\$M** token in the **Identifier format control** parameters. Mangle characters consist of alphanumeric characters that are unique to each object. For more information, see “Control Name Mangling in Generated Identifiers” on page 15-18.

Exceptions to Identifier Formatting Conventions

There are some exceptions to the identifier formatting conventions described in “Identifier Format Control” on page 15-14.

- Type name generation: name mangling conventions do not apply to type names (that is, `typedef` statements) generated for global data types. If the `$R` token is included in the **Identifier format control** parameter specification, the model name is included in the `typedef`. When generating type definitions, the **Maximum identifier length** parameter is not respected.
- Non-Auto storage classes: the **Identifier format control** parameters specification does not affect objects (such as signals and parameters) that have a storage class other than Auto (such as `ImportedExtern` or `ExportedGlobal`).

Identifier Format Control Parameters Limitations

The following limitations apply to the **Identifier format control** parameters:

- The following autogenerated identifiers currently do not fully comply with the setting of the **Maximum identifier length** parameter on the **Code Generation > Symbols** pane of the Configuration Parameters dialog box.
 - Model methods
 - The applicable format string is `RF`, and the longest `$F` is `_derivatives`, which is 12 characters long. The model name can be up to 19 characters without exceeding the default **Maximum identifier length** of 31.
 - Local functions generated by S-functions or by add-on products such as DSP System Toolbox™ that rely on S-functions
 - Local variables generated by S-functions or by add-on products such as DSP System Toolbox that rely on S-functions
 - DW identifiers generated by S-functions in referenced models
 - Fixed-point shared utility macros or shared utility functions
 - Simulink `rtm` macros
 - Most are within the default **Maximum identifier length** of 31, but some exceed the limit. Examples are `RTMSpecAccsGetStopRequestedValStoredAsPtr`, `RTMSpecAccsGetErrorStatusPointer`, and `RTMSpecAccsGetErrorStatusPointerPointer`.
 - Define protection guard macros
 - Header file guards, such as `_RTW_HEADER_$(filename)_h_`, which can exceed the default **Maximum identifier length** of 31 given a filename such as `$R_private.h`.
 - Include file guards, such as `_$R_COMMON_INCLUDES_`.
 - typedef guards, such as `_CSCI_$R_CHARTSTRUCT_`.
- In some situations, the following identifiers potentially can conflict with others.
 - Model methods

- Reentrant model function arguments
- Local functions generated by S-functions or by add-on products such as DSP System Toolbox that rely on S-functions
- Local variables generated by S-functions or by add-on products such as DSP System Toolbox that rely on S-functions
- Fixed-point shared utility macros or shared utility functions
- Include header guard macros
- The following external identifiers that are unknown to the Simulink software might conflict with autogenerated identifiers.
 - Identifiers defined in custom code
 - Identifiers defined in custom header files
 - Identifiers introduced through a non-ANSI C standard library
 - Identifiers defined by custom TLC code
- Identifiers generated for simulation targets might exceed the **Maximum identifier length**. Simulation targets include the model reference simulation target, the accelerated simulation target, the RSim target, and the S-function target.
- Identifiers generated using a model name and bus object data type name, which are both long names, might exceed the **Maximum identifier length**. For example, a ground value variable name is generated as `<model_name>_rtZ<bus_name>`. If the *model_name* and *bus_name* are close to the maximum identifier length, the name exceeds the maximum identifier length.

Specify Simulink Data Object Naming Rules

To Define Rules that Change the Names of...	Specify a Naming Rule with the ...
Signals	Signal naming parameter
Parameters	Parameter naming parameter
Parameters that have a storage class of Define	#define naming parameter

For more information on these parameters, see “Specify Data Object Naming Rules” on page 8-84.

Control Code Style

You can control the following style aspects in generated code:

- Level of parenthesization
- Whether to preserve order of operands in expressions
- Whether to preserve empty primary condition expressions in `if` statements
- Whether to generate code for `if-elseif-else` decision logic as `switch-case` statements
- Whether to include the `extern` keyword in function declarations
- Whether to generate default cases for `switch-case` statements in the code for Stateflow charts

For example, C code contains some syntactically required parentheses, and can contain additional parentheses that change semantics by overriding default operator precedence. C code can also contain optional parentheses that have no functional significance, but serve only to increase the readability of the code. Optional C parentheses vary between two stylistic extremes:

- Include the minimum parentheses required by C syntax and precedence overrides, so that C precedence rules specify all semantics unless overridden by parentheses.
- Include the maximum parentheses that can exist without duplication, so that C precedence rules become irrelevant: parentheses alone completely specify all semantics.

Understanding code with minimum parentheses can require applying nonobvious precedence rules, but maximum parentheses can hinder code reading by belaboring obvious precedence rules. Various parenthesization standards exist that specify one or the other extreme, or define an intermediate style that can be useful to human code readers.

The following example shows the three levels of parentheses control you can set before generating code: `rtwdemo_parentheses`.

Control style options by setting parameters on the **Code Generation > Code Style** pane. For details on the parameters, see “Code Generation Pane: Code Style”.

Customize Code Organization and Format

In this section...
“Custom File Processing Overview” on page 15-28
“Custom File Processing Components” on page 15-29
“Custom File Processing User Interface Options” on page 15-30
“Code Generation Template (CGT) Files” on page 15-31
“Use Custom File Processing (CFP) Templates” on page 15-35
“Custom File Processing (CFP) Template Structure” on page 15-36
“Change the Organization of a Generated File” on page 15-37
“Generate Source and Header Files with a Custom File Processing (CFP) Template” on page 15-39
“Comparison of a Template and Its Generated File” on page 15-48
“Code Template API Summary” on page 15-51
“Generate Custom File and Function Banners” on page 15-55
“Template Symbols and Rules” on page 15-63

Custom File Processing Overview

Customize generated code using code and data templates:

To...	Enter or Select...
Specify a template that defines the top-level organization and formatting of generated source code (.c or .cpp) files	Enter a code generation template (CGT) file for the Source file (*.c) template parameter.
Specify a template that defines the top-level organization and formatting of generated header (.h) files	Enter a CGT file for the Header file (*.h) template parameter. This template file can be the same template file that you specify for Source file (.c) template . If you use the same template file, source and header files contain identical banners. The default template is <i>matlabroot/toolbox/rtw/targets/ecoder/ert_code_template.cgt</i> .

To...	Enter or Select...
Specify a template that organizes generated code into sections (such as includes, typedefs, functions, and more)	Enter a custom file processing (CFP) template file for the “File customization template” parameter. A CFP template can emit code, directives, or comments into each section. For more information, see “Use Custom File Processing (CFP) Templates” on page 15-35.
Generate a model-specific example main program module	Select Generate an example main program . For more information, see “Generate a Standalone Program” on page 20-2.

Note Place the template files that you specify on the MATLAB path.

Custom File Processing Components

Custom file processing (CFP) simplifies generation of custom source code. You can:

- Generate a source (.c or .cpp) or header (.h) file. Using a *custom file processing template* (CFP template), you can control how code emits to the standard generated model files (for example, *model.c* or *.cpp*, *model.h*) or generate files that are independent of model code.
- Organize generated code into sections (such as includes, typedefs, functions, and more). Your CFP template can emit code (for example, functions), directives (such as `#define` or `#include` statements), or comments into each section.
- Generate custom *file banners* (comment sections) at the start and end of generated code files and custom *function banners* that precede functions in the generated code.
- Generate code to call model functions, such as *model_initialize*, *model_step*, and so on.
- Generate code to read and write model inputs and outputs.
- Generate a main program module.
- Obtain information about the model and the generated files from the model.

The custom file processing features are based on the following interrelated components:

- *Code generation template (CGT) files*: a CGT file defines the top-level organization and formatting of generated code. See “Code Generation Template (CGT) Files” on page 15-31.
- *The code template API*: a high-level Target Language Compiler (TLC) API that provides functions with which you can organize code into named sections and subsections of generated source and header files. The code template API also provides utilities that return information about generated files, generate standard model calls, and perform other functions. See “Code Template API Summary” on page 15-51.
- *Custom file processing (CFP) templates*: a CFP template is a TLC file that manages the process of custom code generation. A CFP template assembles code to be generated into buffers. A CFP template also calls the code template API to emit the buffered code into specified sections of generated source and header files. A CFP template interacts with a CGT file, which defines the ordering of major sections of the generated code. See “Use Custom File Processing (CFP) Templates” on page 15-35.

To use CFP templates, you must understand TLC programming, for more information, see “Target Language Compiler”.

Custom File Processing User Interface Options

To use custom file processing features, create CGT files and CFP templates. These files are based on default templates provided by the code generation software. Once you have created your templates, you must integrate them into the code generation process.

Select and edit CGT files and CFP templates, and specify their use in the code generation process in the **Code Generation > Templates** pane of a model configuration set. The following figure shows options configured for their defaults.

The options related to custom file processing are:

- The **Source file (.c) template** field in the **Code templates** and **Data templates** sections. This field specifies the name of a CGT file to use

when generating source (.c or .cpp) files. You must place this file on the MATLAB path.

- The **Header file (.h) template** field in the **Code templates** and **Data templates** sections. This field specifies the name of a CGT file to use when generating header (.h) files. You must place this file on the MATLAB path.

By default, the template for both source and header files is `matlabroot/toolbox/rtw/targets/ecoder/ert_code_template.cgt`.

- The **File customization template** edit field in the **Custom templates** section. This field specifies the name of a CFP template file to use when generating code files. You must place this file on the MATLAB path. The default CFP template is `matlabroot/toolbox/rtw/targets/ecoder/example_file_process.tlc`.

In each of these fields, click **Browse** to navigate to and select an existing CFP template or CGT file. Click **Edit** to open the specified file into the MATLAB editor where you can customize it.

Code Generation Template (CGT) Files

CGT files have the following applications:

- Generation of custom banners (comments sections) in code files. See “Generate Custom File and Function Banners” on page 15-55.
- Generation of custom code using a CFP template requires a CGT file. To use CFP templates, you must understand the CGT file structure. In many cases, however, you can use the default CGT file without modifying it.

Default CGT file

The code generation software provides a default CGT file, `matlabroot/toolbox/rtw/targets/ecoder/ert_code_template.cgt`. Base your custom CGT files on the default file.

CGT File Structure

A CGT file consists of one required section and four optional sections:

Code Insertion Section. (Required) This section contains tokens that define an ordered partitioning of the generated code into a number of sections (such as `Includes` and `Defines` sections). Tokens have the form of:

```
%<SectionName>
```

For example,

```
%<Includes>
```

The code generation software defines a minimal set of required tokens. These tokens generate C or C++ source or header code. They are *built-in* tokens (see “Built-In Tokens and Sections” on page 15-33). You can also define custom tokens and custom sections.

Each token functions as a placeholder for a corresponding section of generated code. The ordering of the tokens defines the order in which the corresponding sections appear in the generated code. If you do not include a token, then the corresponding section is not generated. To generate code into a given section, explicitly call the code template API from a CFP template, as described in “Use Custom File Processing (CFP) Templates” on page 15-35.

The CGT tokens define the high-level organization of generated code. Using the code template API, you can partition each code section into named subsections, as described in “Subsections” on page 15-34.

In the code insertion section, you can also insert C or C++ comments between tokens. Such comments emit directly into the generated code.

File Banner Section. (Optional) This section contains comments and tokens you use in generating a custom file banner.

Function Banner Section. (Optional) This section contains comments and tokens for use in generating a custom function banner.

Shared Utility Function Banner Section. (Optional) This section contains comments and tokens for use in generating a custom shared utility function banner.

File Trailer Section. (Optional) This section contains comments for use in generating a custom trailer banner.

For more information on these sections, see “Generate Custom File and Function Banners” on page 15-55.

Built-In Tokens and Sections

The following code extract shows the required code insertion section of the default CGT file with the required built-in tokens.

```

%%%%%%%%%%%%%%%%%%%%%%%%%%%%%%%%%%%%%%%%%%%%%%%%%%%%%%%%%%%%%%%%%%%%%%%%
%% Code insertion section (required)
%%   These are required tokens. You can insert comments and other tokens in
%%   between them, but do not change their order or remove them.
%%
%<Includes>
%<Defines>
%<Types>
%<Enums>
%<Definitions>
%<Declarations>
%<Functions>

```

Note the following requirements for customizing a CGT file:

- Do not remove required built-in tokens.
- Built-in tokens must appear in the order shown because each successive section has dependencies on previous sections.
- Only one token per line.
- Do not repeat tokens.
- You can add custom tokens and comments to the code insertion section as long as you do not violate the previous requirements.

Note If you modify a CGT file and then rebuild your model, the code generation process does not force a top model build. To regenerate the code, see “Force Regeneration of Top Model Code”.

The following table summarizes the built-in tokens and corresponding section names, and describes the code sections.

Built-In CGT Tokens and Corresponding Code Sections

Token and Section Name	Description
Includes	<code>#include</code> directives section
Defines	<code>#define</code> directives section
Types	<code>typedef</code> section. Typedefs can depend on a previously defined type
Enums	Enumerated types section
Definitions	Data definitions (for example, <code>double x = 3.0;</code>)
Declarations	Data declarations (for example, <code>extern double x;</code>)
Functions	C or C++ functions

Subsections

You can define one or more named subsections for any section. Some of the built-in sections have predefined subsections summarized in table Subsections Defined for Built-In Sections on page 15-34.

Note Sections and subsections emit to the source or header file in the order listed in the CGT file.

Using the custom section feature, you can define additional sections. See “Generate a Custom Section” on page 15-46.

Subsections Defined for Built-In Sections

Section	Subsections	Subsection Description
Includes	N/A	
Defines	N/A	

Subsections Defined for Built-In Sections (Continued)

Section	Subsections	Subsection Description
Types	IntrinsicTypes	Intrinsic typedef section. Intrinsic types depend only on intrinsic C or C++ types.
Types	PrimitiveTypedefs	Primitive typedef section. Primitive typedefs depend only on intrinsic C or C++ types and on typedefs previously defined in the IntrinsicTypes section.
Types	UserTop	You can place any type of code in this section, including code that has dependencies on the previous sections.
Types	Typedefs	typedef section. Typedefs can depend on previously defined types
Enums	N/A	
Definitions	N/A	
Declarations	N/A	
Functions		C or C++ functions
Functions	CompilerErrors	#error directives
Functions	CompilerWarnings	#warning directives
Functions	Documentation	Documentation (comment) section
Functions	UserBottom	You can place any code in this section.

Use Custom File Processing (CFP) Templates

The files provided to support custom file processing are

- `matlabroot/rtw/c/tlc/mw/codetemplatelib.tlc`: A TLC function library that implements the code template API. `codetemplatelib.tlc` also provides the comprehensive documentation of the API in the comments headers preceding each function.
- `matlabroot/toolbox/rtw/targets/ecoder/example_file_process.tlc`: An example custom file processing (CFP) template, which you should use

as the starting point for creating your own CFP templates. Guidelines and examples for creating a CFP template are provided in “Generate Source and Header Files with a Custom File Processing (CFP) Template” on page 15-39.

- TLC files supporting generation of single-rate and multirate main program modules (see “Customizing Main Program Module Generation” on page 15-44).

Once you have created a CFP template, you must integrate it into the code generation process, using the **File customization template** edit field. See “Custom File Processing User Interface Options” on page 15-30.

Custom File Processing (CFP) Template Structure

A custom file processing (CFP) template imposes a simple structure on the code generation process. The template, a code generation template (CGT) file, partitions the code generated for each file into a number of sections. These sections are summarized in Built-In CGT Tokens and Corresponding Code Sections on page 15-34 and Subsections Defined for Built-In Sections on page 15-34.

Code for each section is assembled in buffers and then emitted, in the order listed, to the file being generated.

To generate a file section, your CFP template must first assemble the code to be generated into a buffer. Then, to emit the section, your template calls the TLC function

```
LibSetSourceFileSection(fileH, section, tmpBuf)
```

where

- `fileH` is a file reference to a file being generated.
- `section` is the code section or subsection to which code is to be emitted. `section` must be one of the section or subsection names listed in Subsections Defined for Built-In Sections on page 15-34.

Determine the `section` argument as follows:

- If Subsections Defined for Built-In Sections on page 15-34 does not define subsections for a given section, use the section name as the `section` argument.
 - If Subsections Defined for Built-In Sections on page 15-34 defines one or more subsections for a given section, you can use either the section name or a subsection name as the `section` argument.
 - If you have defined a custom token denoting a custom section, do not call `LibSetSourceFileSection`. Special API calls are provided for custom sections (see “Generate a Custom Section” on page 15-46).
- `tmpBuf` is the buffer containing the code to be emitted.

There is no requirement to generate all of the available sections. Your template need only generate the sections you require in a particular file.

Note that legality or syntax checking is not performed on the custom code within each section.

The next section, “Generate Source and Header Files with a Custom File Processing (CFP) Template” on page 15-39, provides typical usage examples.

Change the Organization of a Generated File

The files you generated in the previous procedures are organized according to the general code generation template. This template has the filename `ert_code_template.cgt`, and is specified by default in **Code Generation > Templates** pane of the Configuration Parameters dialog box.

The following fragment shows the `rtwdemo_mpf.c` file header that is generated using this default template:

```
/*
 * File: rtwdemo_mpf.c
 *
 * Code generated for Simulink model 'rtwdemo_mpf'.
 *
 * Model version                : 1.88
 * Simulink Coder version       : 8.0 (R2011a) 26-Aug-2010
 * TLC version                  : 7.6 (Sep 3 2010)
 * C/C++ source code generated on : Thu Sep 09 10:10:14 2010
 *
 * Target selection: ert.tlc
 * Embedded hardware selection: Generic->32-bit Embedded Processor
 * Code generation objectives: Unspecified
 * Validation result: Not run
 */
```

You can change the organization of generated files using code templates and data templates. Code templates organize the files that contain functions, primarily. Data templates organize the files that contain identifiers. In this procedure, you organize the generated files, using the supplied MPF code and data templates:

- 1** Display the active **Templates** configuration parameters.
- 2** In the **Code templates** section of the **Templates** pane, type `code_c_template.cgt` into the **Source file (*.c) templates** text box.
- 3** Type `code_h_template.cgt` into the **Header file (*.h) templates** text box.
- 4** In the **Data templates** section, type `data_c_template.cgt` into the **Source file (*.c) templates** text box.
- 5** Type `data_h_template.cgt` into the **Header file (*.h) templates** text box, and click **Apply**.

- 6** Click **Generate code**. Now the files are organized using the templates you specified. For example, the `rtwdemo_mpf.c` file header now is organized like this:

```

/**
*****
** FILE INFORMATION:
** Filename:          rtwdemo_mpf.c
** File Creation Date: 09-Sep-2010
**
** ABSTRACT:
**
**
** NOTES:
**
**
** MODEL INFORMATION:
** Model Name:        rtwdemo_mpf
** Model Description: Data packaging examples
** Model Version:     1.89
** Model Author:      The MathWorks Inc. - Mon Mar 01 11:23:00 2004
**
** MODIFICATION HISTORY:
** Model at Code Generation: ssulliva - Thu Sep 09 10:19:35 2010
**
** Last Saved Modification: ssulliva - Thu Sep 09 10:19:13 2010
**
*****
**/

```

Generate Source and Header Files with a Custom File Processing (CFP) Template

This example shows you the process of generating a simple source (.c or .cpp) and header (.h) file using the example CFP template. Then, it examines the template and the code generated by the template.

The example CFP template, `matlabroot/toolbox/rtw/targets/ecoder/example_file_process.tlc`, demonstrates some of the capabilities of the code template API, including

- Generation of simple source (.c or .cpp) and header (.h) files
- Use of buffers to generate file sections for includes, functions, and so on
- Generation of includes, defines, into the standard generated files (for example, `model.h`)
- Generation of a main program module

Generate Code with a CFP Template

This section sets up a CFP template and configures a model to use the template in code generation. The template generates (in addition to the standard model files) a source file (`timestwo.c` or `.cpp`) and a header file (`timestwo.h`).

Follow the steps below to become acquainted with the use of CFP templates:

- 1** Copy the example CFP template, `matlabroot/toolbox/rtw/targets/ecoder/example_file_process.tlc`, to a folder outside of the MATLAB folder structure (that is, not under `matlabroot`). If the folder is not on the MATLAB path or the TLC path, then add it to the MATLAB path. It is good practice to locate the CFP template in the same folder as your system target file, which is on the TLC path.
- 2** Rename the copied `example_file_process.tlc` to `test_example_file_process.tlc`.
- 3** Open `test_example_file_process.tlc` into the MATLAB editor.
- 4** Uncomment the following line:

```
%% %assign ERTCustomFileTest = TLC_TRUE
```

It now reads:

```
%assign ERTCustomFileTest = TLC_TRUE
```

If `ERTCustomFileTest` is not assigned as shown, the CFP template is ignored in code generation.

- 5** Save your changes to the file. Keep `test_example_file_process.tlc` open, so you can refer to it later.
- 6** Open the `rtwdemo_udt` model.
- 7** Open the Simulink Model Explorer. Select the active configuration set of the model, and open the **Code Generation** pane of the active configuration set.
- 8** Click the **Templates** tab.
- 9** Specify **File customization template** as `test_example_file_process.tlc`. This is the file you previously edited and is now the specified CFP template for your model.
- 10** Select the **Generate code only** option.
- 11** Click **Apply**.
- 12** Click **Generate code**. During code generation, notice the following message on the MATLAB command window:

```
Warning: Overriding example ert_main.c!
```

This message is displayed because `test_example_file_process.tlc` generates the main program module, overriding the default action of the ERT target. This is explained in greater detail below.
- 13** The `rtwdemo_udt` model is configured to generate an HTML code generation report. After code generation completes, view the report. Notice that the **Generated Files** list contains the files `timestwo.c`, `timestwo.h`, and `ert_main.c`. These files were generated by the CFP template. The next section examines the template to learn how this was done.
- 14** Keep the model, the code generation report, and the `test_example_file_process.tlc` file open so you can refer to them in the next section.

Analysis of the Example CFP Template and Generated Code

This section examines excerpts from `test_example_file_process.tlc` and some of the code it generates. Refer to the comments in `matlabroot/rtw/c/tlc/mw/codetemplatelib.tlc` while reading the following discussion.

Generating Code Files. Source (.c or .cpp) and header (.h) files are created by calling `LibCreateSourceFile`, as in the following excerpts:

```
%assign cFile = LibCreateSourceFile("Source", "Custom", "timestwo")
...
%assign hFile = LibCreateSourceFile("Header", "Custom", "timestwo")
```

Subsequent code refers to the files by the file reference returned from `LibCreateSourceFile`.

File Sections and Buffers. The code template API lets you partition the code generated to each file into sections, tagged as `Definitions`, `Includes`, `Functions`, `Banner`, and so on. You can append code to each section as many times as required. This technique gives you a great deal of flexibility in the formatting of your custom code files.

[Subsections Defined for Built-In Sections on page 15-34](#) describes the available file sections and their order in the generated file.

For each section of a generated file, use `%openfile` and `%closefile` to store the text for that section in temporary buffers. Then, to write (append) the buffer contents to a file section, call `LibSetSourceFileSection`, passing in the desired section tag and file reference. For example, the following code uses two buffers (`tmwtypesBuf` and `tmpBuf`) to generate two sections (tagged "Includes" and "Functions") of the source file `timestwo.c` or `.cpp` (referenced as `cFile`):

```
%openfile tmwtypesBuf

#include "tmwtypes.h"

%closefile tmwtypesBuf

%<LibSetSourceFileSection(cFile,"Includes",tmwtypesBuf)>
```

```

%openfile tmpBuf

/* Times two function */
real_T timestwofcn(real_T input) {
    return (input * 2.0);
}

%closefile tmpBuf

%<LibSetSourceFileSection(cFile, "Functions", tmpBuf)>

```

These two sections generate the entire `timestwo.c` or `.cpp` file:

```

#include "tmwtypes.h"

/* Times two function */
FLOAT64 timestwofcn(FLOAT64 input)
{
    return (input * 2.0);
}

```

Adding Code to Standard Generated Files. The `timestwo.c` or `.cpp` file generated in the previous example was independent of the standard code files generated from a model (for example, `model.c` or `.cpp`, `model.h`, and so on). You can use similar techniques to generate custom code within the model files. The code template API includes functions to obtain the names of the standard models files and other model-related information. The following excerpt calls `LibGetMdlPubHdrBaseName` to obtain the name for the `model.h` file. It then obtains a file reference and generates a definition in the `Defines` section of `model.h`:

```

%% Add a #define to the model's public header file model.h

%assign pubName = LibGetMdlPubHdrBaseName()
%assign modelH = LibCreateSourceFile("Header", "Simulink", pubName)

%openfile tmpBuf

#define ACCELERATION 9.81

```

```
%closefile tmpBuf

%<LibSetSourceFileSection(modelH,"Defines",tmpBuf)>
```

Examine the generated `rtwdemo_udt.h` file to see the generated `#define` directive.

Customizing Main Program Module Generation. Normally, the ERT target determines whether and how to generate an `ert_main.c` or `.cpp` module based on the settings of the **Generate an example main program** and **Target operating system** options on the **Templates** pane of the Configuration Parameters dialog box. You can use a CFP template to override the normal behavior and generate a main program module customized for your target environment.

To support generation of main program modules, two TLC files are provided:

- `bareboard_srmain.tlc`: TLC code to generate an example single-rate main program module for a bareboard target environment. Code is generated by a single TLC function, `FcnSingleTaskingMain`.
- `bareboard_mrmain.tlc`: TLC code to generate a multirate main program module for a bareboard target environment. Code is generated by a single TLC function, `FcnMultiTaskingMain`.

In the example CFP template file `matlabroot/toolbox/rtw/targets/ecoder/example_file_process.tlc`, the following code generates either a single- or multitasking `ert_main.c` or `.cpp` module. The logic depends on information obtained from the code template API calls `LibIsSingleRateModel` and `LibIsSingleTasking`:

```
%% Create a simple main. Files are located in MATLAB/rtw/c/tlc/mw.

%if LibIsSingleRateModel() || LibIsSingleTasking()
    %include "bareboard_srmain.tlc"
    %<FcnSingleTaskingMain()>
%else
    %include "bareboard_mrmain.tlc"
    %<FcnMultiTaskingMain()>
%endif
```

Note that `bareboard_srmain.tlc` and `bareboard_mrmain.tlc` use the code template API to generate `ert_main.c` or `.cpp`.

When generating your own main program module, you disable the default generation of `ert_main.c` or `.cpp`. The TLC variable `GenerateSampleERTMain` controls generation of `ert_main.c` or `.cpp`. You can directly force this variable to `TLC_FALSE`. The examples `bareboard_mrmain.tlc` and `bareboard_srmain.tlc` use this technique, as shown in the following excerpt from `bareboard_srmain.tlc`.

```
%if GenerateSampleERTMain
    %assign CompiledModel.GenerateSampleERTMain = TLC_FALSE
    %warning Overriding example ert_main.c!
%endif
```

Alternatively, you can implement a `SelectCallback` function for your target. A `SelectCallback` function is a MATLAB function that is triggered during model loading, and also when the user selects a target with the System Target File browser. Your `SelectCallback` function should deselect and disable the **Generate an example main program** option. This prevents the TLC variable `GenerateSampleERTMain` from being set to `TLC_TRUE`.

See the “`rtwgensettings Structure`” section for information on creating a `SelectCallback` function.

The following code illustrates how to deselect and disable the **Generate an example main program** option in the context of a `SelectCallback` function.

```
slConfigUISetVal(hDlg, hSrc, 'GenerateSampleERTMain', 'off');
slConfigUISetEnabled(hDlg, hSrc, 'GenerateSampleERTMain', 0);
```

Note Creation of a main program for your target environment requires some customization; for example, in a bareboard environment you need to attach `rt_OneStep` to a timer interrupt. It is expected that you will customize either the generated code, the generating TLC code, or both. See “Guidelines for Modifying the Main Program” on page 20-4 and “Guidelines for Modifying `rt_OneStep`” on page 20-10 for further information.

Generate a Custom Section

You can define custom tokens in a CGT file and direct generated code into an associated built-in section. This feature gives you additional control over the formatting of code within each built-in section. For example, you could add subsections to built-in sections that do not already define subsections. Custom sections must be associated with one of the built-in sections: `Includes`, `Defines`, `Types`, `Enums`, `Definitions`, `Declarations`, or `Functions`. To create custom sections, you must

- Add a custom token to the code insertion section of your CGT file.
- In your CFP file:
 - Assemble code to be generated to the custom section into a buffer.
 - Declare an association between the custom section and a built-in section, with the code template API function `LibAddSourceFileCustomSection`.
 - Emit code to the custom section with the code template API function `LibSetSourceFileCustomSection`.

The following code examples illustrate the addition of a custom token, `Myincludes`, to a CGT file, and the subsequent association of the custom section `Myincludes` with the built-in section `Includes` in a CFP file.

Note If you have not already created custom CGT and CFP files for your model, copy the default template files `matlabroot/toolbox/rtw/targets/ecoder/ert_code_template.cgt` and `matlabroot/toolbox/rtw/targets/ecoder/example_file_process.tlc` to a work folder that is outside the MATLAB folder structure but on the MATLAB or TLC path, rename them (for example, add the prefix `test_` to each file), and update the **Templates** pane of the Configuration Parameters dialog box to reference them.

First, add the token `Myincludes` to the code insertion section of your CGT file. For example:

```
%<Includes>  
%<Myincludes>  
%<Defines>
```

```

%<Types>
%<Enums>
%<Definitions>
%<Declarations>
%<Functions>

```

Next, in the CFP file, add code to generate `include` directives into a buffer. For example, in your copy of the example CFP file, you could insert the following section between the `Includes` section and the `Create a simple main` section:

```

%% Add a custom section to the model's C file model.c

%openfile tmpBuf
#include "moretables1.h"
#include "moretables2.h"
%closefile tmpBuf

%<LibAddSourceFileCustomSection(modelC,"Includes","Myincludes")>
%<LibSetSourceFileCustomSection(modelC,"Myincludes",tmpBuf)>

```

The `LibAddSourceFileCustomSection` function call declares an association between the built-in section `Includes` and the custom section `Myincludes`. `Myincludes` is a subsection of `Includes`. The `LibSetSourceFileCustomSection` function call directs the code in the `tmpBuf` buffer to the `Myincludes` section of the generated file. `LibSetSourceFileCustomSection` is syntactically identical to `LibSetSourceFileSection`.

In the generated code, the `include` directives generated to the custom section appear after other code directed to `Includes`.

```

#include "rtwdemo_udt.h"
#include "rtwdemo_udt_private.h"

/* #include "mytables.h" */
#include "moretables1.h"
#include "moretables2.h"

```

Note The placement of the custom token in this example CGT file is arbitrary. By locating %<Myincludes> after %<Includes>, the CGT file specifies only that the Myincludes code appears after Includes code.

Custom Tokens

Custom tokens are automatically translated to TLC syntax as a part of the build process. To escape a token, that is to prepare it for normal TLC expansion, use the '?' character. For example, the token %<!TokenName> is expanded to %<TokenName> by the template conversion program. You can specify valid TLC code, including TLC function calls: %<!MyTLCFn()>.

Comparison of a Template and Its Generated File

The next figure shows part of a user-modified MPF template and the resulting generated code. This figure illustrates how you can use a template to

- Define what code the code generation software should add to the generated file
- Control the location of code in the file
- Optionally insert comments in the generated file

Notice %<Includes>, for example, on the template. The term **Includes** is a symbol name. A percent sign and brackets (%< >) must enclose every symbol name. You can add the desired symbol name (within the %< > delimiter) at a particular location in the template. This is how you control where the code generator places an item in the generated file.

Template and Generated File



Mapping Template Specification to Code Generation

This part of the template...		Generates in the file...		Explanation
		Line	Description	
(1)	<code>/*#INCLUDES*/ %<Includes></code>	26–28	An <code>/*#INCLUDES*/</code> comment, followed by <code>#include</code> statements	The code generator adds the C/C++ comment as a header, and then interprets the <code>%<Includes></code> template symbol to list the required <code>#include</code> statements in the file. This code is first in this section of the file because the template entries are first.
(2)	<code>/*DEFINES*/ %<Defines></code>	30	A <code>/*DEFINES*/</code> comment, but no <code>#define</code> statements	Next, the code generator places the comment as a header for <code>#define</code> statements, but the file does not need <code>#define</code> . No code is added.
(3)	<code>#pragma string1</code>	31	<code>#pragma</code> statements	While the code generator requires <code>%<></code> delimiters for template symbols, it can also interpret C/C++ statements in the template without delimiters. In this case, the generator adds the specified statements to the code, following the order in which the statements appear in the template.
(5)	<code>#pragma string2</code>	42		
(4)	<code>/*#DEFINITIONS*/ %<Definitions></code>	32–41	<code>/*#DEFINITIONS*/</code> comment, followed by definitions	The code generator places the comment and definitions in the file between the <code>#pragma</code> statements, according to the order in the template. It also inserts comments (lines 33 and 36) that are preset in the model's Configuration Parameters dialog box.

Mapping Template Specification to Code Generation (Continued)

This part of the template...		Generates in the file...		Explanation
		Line	Description	
(6)	%<Declarations>	43	No declarations	The file needs no declarations, so the code generator does not generate declarations for this file. The template does not have a comment to provide a header. Line 43 is left blank.
(7)	%<Functions>	44–74	Functions	Finally, the code generator adds functions from the model, plus comments that are preset in the Configuration Parameters dialog box. But it adds no comments as a header for the functions, because the template does not have one. This code is last because the template entry is last.

For a list of template symbols and the rules for using them, see “Template Symbol Groups” on page 15-64, “Template Symbols” on page 15-66, and “Rules for Modifying or Creating a Template” on page 15-70. To set comment options, from the **Simulation** menu, select **Model Configuration Parameters**. On the Configuration Parameters dialog box, select the **Code Generation > Comments** pane. For details, see “Configure Code Comments”.

Code Template API Summary

Code Template API Functions on page 15-52 summarizes the code template API. See the source code in *matlabroot/rtw/c/tlc/mw/codetemplatelib.tlc* for detailed information on the arguments, return values, and operation of these calls.

Code Template API Functions

Function	Description
LibGetNumSourceFiles	Returns the number of created source files (.c or .cpp and .h).
LibGetSourceFileTag	Returns <filename>_h and <filename>_c for header and source files, respectively, where filename is the name of the model file.
LibCreateSourceFile	Creates a new C or C++ file and returns its reference. If the file already exists, simply returns its reference.
LibGetSourceFileFromIdx	Returns a model file reference based on its index. This is useful for a common operation on all files, such as to set the leading file banner of all files.
LibSetSourceFileSection	Adds to the contents of a specified section within a specified file (see also “Custom File Processing (CFP) Template Structure” on page 15-36).
LibIndentSourceFile	Indents a file with the c_indent utility (from within the TLC environment).
LibCallModelInitialize	Returns code for calling the model’s <i>model_initialize</i> function (valid for ERT only).
LibCallModelStep	Returns code for calling the model’s <i>model_step</i> function (valid for ERT only).
LibCallModelTerminate	Returns code for calling the model’s <i>model_terminate</i> function (valid for ERT only).
LibCallSetEventForThisBaseStep	Returns code for calling the model’s set events function (valid for ERT only).
LibWriteModelData	Returns data for the model (valid for ERT only).

Code Template API Functions (Continued)

Function	Description
LibSetRTModelErrorStatus	Returns the code to set the model error status.
LibGetRTModelErrorStatus	Returns the code to get the model error status.
LibIsSingleRateModel	Returns true if model is single rate and false otherwise.
LibGetModelName	Returns name of the model (without an extension).
LibGetMdlSrcBaseName	Returns the name of model's main source file (for example, <i>model.c</i> or <i>.cpp</i>).
LibGetMdlPubHdrBaseName	Returns the name of model's public header file (for example, <i>model.h</i>).
LibGetMdlPrvHdrBaseName	Returns the name of the model's private header file (for example, <i>model_private.h</i>).
LibIsSingleTasking	Returns true if the model is configured for single-tasking execution.
LibWriteModelInput	Returns the code to write to a particular root input (that is, a model inport block). (valid for ERT only).
LibWriteModelOutput	Returns the code to write to a particular root output (that is, a model outport block). (valid for ERT only).
LibWriteModelInputs	Returns the code to write to root inputs (that is, all model inport blocks). (valid for ERT only)
LibWriteModelOutputs	Returns the code to write to root outputs (that is, all model outport blocks). (valid for ERT only).

Code Template API Functions (Continued)

Function	Description
<code>LibNumDiscreteSampleTimes</code>	Returns the number of discrete sample times in the model.
<code>LibSetSourceFileCodeTemplate</code>	Set the code template to be used for generating a specified source file.
<code>LibSetSourceFileOutputDirectory</code>	Set the folder into which a specified source file is to be generated.
<code>LibAddSourceFileCustomSection</code>	Add a custom section to a source file. The custom section must be associated with one of the built-in (required) sections: <code>Includes</code> , <code>Defines</code> , <code>Types</code> , <code>Enums</code> , <code>Definitions</code> , <code>Declarations</code> , or <code>Functions</code> .
<code>LibSetSourceFileCustomSection</code>	Adds to the contents of a specified custom section within a specified file. The custom section must have been previously created with <code>LibAddSourceFileCustomSection</code> .
<code>LibGetSourceFileCustomSection</code>	Returns the contents of a specified custom section within a specified file.
<code>LibSetCodeTemplateComplianceLevel</code>	<p>This function must be called from your CFP template before other code template API functions are called. Pass in 2 as the <code>level</code> argument.</p> <hr/> <p>Note Some MathWorks TLC files pass in 1 as the <code>level</code> argument. Currently, there is no difference in handling of level 1 versus level 2 by MathWorks software.</p> <hr/>

Generate Custom File and Function Banners

Using code generation template (CGT) files, you can specify custom file banners and function banners for the generated code files. File banners are comment sections in the header and trailer sections of a generated file. Function banners are comment sections for each function in the generated code. Use these banners to add a company copyright statement, specify a special version symbol for your configuration management system, remove time stamps, and for many other purposes. These banners can contain characters, which propagate to the generated code.

To specify banners, create a custom CGT file with customized banner sections. The build process creates an executable TLC file from the CGT file. The code generation process then invokes the TLC file.

You do not need to be familiar with TLC programming to generate custom banners. You can modify example files that are supplied with the ERT target.

Note Prior releases supported direct use of customized TLC files as banner templates. You specified these with the **Source file (.c) banner template** and **Header file (.h) banner template** options of the ERT target. You can still use a custom TLC file banner templates, however, you can now use CGT files instead.

ERT template options on the **Code Generation > Templates** pane of a configuration set, in the **Code templates** section, support banner generation.

The options for function and file banner generation are:

- “Code templates: Source file (*.c) template”: CGT file to use when generating source (.c or .cpp) files. Place this file on the MATLAB path.
- “Code templates: Header file (*.h) template”: CGT file to use when generating header (.h) files. You must place this file on the MATLAB path. This file can be the same template specified in the **Code templates: Source file (*.c) template** field, in which case identical banners are generated in source and header files.

By default, the template for both source and header files is `matlabroot/toolbox/rtw/targets/ecoder/ert_code_template.cgt`.

- In each of these fields, click **Browse** to navigate to and select an existing CGT file for use as a template. Click **Edit** to open the specified file into the MATLAB editor, where you can customize it.

Create a Custom File and Function Banner Template

To customize a CGT file for custom banner generation, make a local copy of the default code template and edit it, as follows:

- 1 Activate the configuration set you that want to work with.
- 2 Open the **Code Generation** pane of the active configuration set.
- 3 Click the **Templates** tab.
- 4 By default, the code template specified in the **Code templates: Source file (*.c) template** and **Code templates: Header file (*.h) template** fields is `matlabroot/toolbox/rtw/targets/ecoder/ert_code_template.cgt`.
- 5 If you want to use a different template as your starting point, click **Browse** to locate and select a CGT file.
- 6 Click **Edit** button to open the CGT file into the MATLAB editor.
- 7 Save a local copy of the CGT file. Store the copy in a folder that is outside of the MATLAB folder structure, but on the MATLAB path. If required, add the folder to the MATLAB path.
- 8 If you intend to use the CGT file with a custom target, locate the CGT file in a folder under your target root folder.
- 9 Rename your local copy of the CGT file. When you rename the CGT file, update the associated **Code templates: Source file (*.c) template** or **Code templates: Header file (*.h) template** field to match the new file name.
- 10 Edit and customize the local copy of the CGT file for banner generation, using the information provided in “Customize a Code Generation Template (CGT) File for File and Function Banner Generation” on page 15-58.
- 11 Save your changes to the CGT file.
- 12 Click **Apply** to update the configuration set.
- 13 Save your model.

- 14** Generate code. Examine the generated source and header files to confirm that they contain the banners specified by the template or templates.

Customize a Code Generation Template (CGT) File for File and Function Banner Generation

This section describes how to edit a CGT file for custom file and function banner generation. For a description of CGT files, see “Code Generation Template (CGT) Files” on page 15-31.

Components of the File and Function Banner Sections in the CGT file.

In a CGT file, you can modify the following sections: file banner, function banner, shared utility function banner, and file trailer. Each section is defined by open and close tags. The tags specific to each section are shown in the following table.

CGT File Section	Open Tag	Close Tag
File Banner	<FileBanner>	</FileBanner>
Function Banner	<FunctionBanner>	</FunctionBanner>
Shared-utility Banner	<SharedUtilityBanner>	</SharedUtilityBanner>
File Trailer	<FileTrailer>	</FileTrailer>

You can customize your banners by including tokens and comments between the open and close tag for each section. Tokens are typically TLC variables, for example <ModelVersion>, which are replaced with values in the generated code.

Note Including C comment indicators, `/*` or `*/`, in the contents of your banner might introduce an error in the generated code.

An open tag includes tag attributes. Enclose the value of the attribute in double quotes. The attributes available for an open tag are:

- `width`: specifies the width of the file or function banner comments in the generated code. The default value is 80.

- `style`: specifies the boundary for the file or function banner comments in the generated code.

The open tag syntax is as follows:

```
<OpenTag style = "style_value" width = "num_width">
```

The built-in style options for the `style` attribute are:

- `classic`

```
/* single line comments */
/*
 * multiple line comments
 * second line
 */
```

- `classic_cpp`

```
// single line comments
//
// multiple line comments
// second line
//
```

- `box`

```
/******
/* banner contents */
/******
```

- `box_cpp`

```
////////////////////////////////////
// banner contents //
////////////////////////////////////
```

- `open_box`

```
*****
 * banner contents
*****
```

- open_box_cpp

```

////////////////////////////////////
// banner contents
////////////////////////////////////

```

File Banner. This section contains comments and tokens for use in generating a custom file banner. The file banner precedes C or C++ code generated by the model. If you omit the file banner section from the CGT file, then no file banner emits to the generated code. The following section is the file banner section provided with the default CGT file, *matlabroot/toolbox/rtw/targets/ecoder/ert_code_template.cgt*.

```

%%%%%%%%%%%%%%%%%%%%%%%%%%%%%%%%%%%%%%%%%%%%%%%%%%%%%%%%%%%%%%%%%%%%%%%%
%% Custom file banner section (optional)
%%
<FileBanner style="classic">
File: %<FileName>

Code generated for Simulink model %<ModelName>.

Model version                : %<ModelVersion>
Simulink Coder version       : %<RTWFileVersion>
TLC version                  : %<TLCVersion>
C/C++ source code generated on : %<SourceGeneratedOn>
%<CodeGenSettings>
</FileBanner>

```

Summary of Tokens for File Banner Generation

FileName	Name of the generated file (for example, "rtwdemo_udt.c").
FileType	Either "source" or "header". Designates whether generated file is a .c or .cpp file or an .h file.
FileTag	Given file names file.c or .cpp and file.h; the file tags are "file_c" and "file_h", respectively.
ModelName	Name of generating model.

Summary of Tokens for File Banner Generation (Continued)

ModelVersion	Version number of model.
RTWFileVersion	Version number of <i>model.rtw</i> file.
RTWFileGeneratedOn	Timestamp of <i>model.rtw</i> file.
TLCVersion	Version of Target Language Compiler.
SourceGeneratedOn	Timestamp of generated file.
CodeGenSettings	Code generation settings for model: target language, target selection, embedded hardware selection, emulation hardware selection, code generation objectives (in priority order), and Code Generation Advisor validation result.

Function Banner. This section contains comments and tokens for use in generating a custom function banner. The function banner precedes C or C++ function generated during the build process. If you omit the function banner section from the CGT file, the default function banner emits to the generated code. The following section is the default function banner section provided with the default CGT file, *matlabroot/toolbox/rtw/targets/ecoder/ert_code_template.cgt*.

```

%%%%%%%%%%%%%%%%%%%%%%%%%%%%%%%%%%%%%%%%%%%%%%%%%%%%%%%%%%%%%%%%%%%%%%%%
%% Custom function banner section (optional)
%% Customize function banners by using the following predefined tokens:
%% %<ModelName>, %<FunctionName>, %<FunctionDescription>, %<Arguments>,
%% %<ReturnType>, %<GeneratedFor>, %<BlockDescription>.
%%
<FunctionBanner style="classic">
%<FunctionDescription>
%<BlockDescription>
</FunctionBanner>

```

Summary of Tokens for Function Banner Generation

FunctionName	Name of function
Arguments	List of function arguments

Summary of Tokens for Function Banner Generation (Continued)

ReturnType	Return type of function
ModelName	Name of generating model
FunctionDescription	Short abstract about the function
GeneratedFor	Full block path for the generated function
BlockDescription	User input from the Block Description parameter of the block properties dialog box. BlockDescription contains an optional token attribute, <code>style</code> . The only valid value for <code>style</code> is <code>content_only</code> , which is case-sensitive and enclosed in double quotes. Use the <code>content_only</code> style when you want to include only the block description content that you entered in the block parameter dialog. The syntax for the token attribute <code>style</code> is: %<BlockDescription style = content_only >

Shared Utility Function Banner. The shared utility function banner section contains comments and tokens for use in generating a custom shared utility function banner. The shared utility function banner precedes C or C++ shared utility function generated during the build process. If you omit the shared utility function banner section from the CGT file, the default shared utility function banner emits to the generated code. The following section is the default shared utility function banner section provided with the default CGT file, *matlabroot/toolbox/rtw/targets/ecoder/ert_code_template.cgt*.

```

%%%%%%%%%%%%%%%%%%%%%%%%%%%%%%%%%%%%%%%%%%%%%%%%%%%%%%%%%%%%%%%%%%%%%%%%
% Custom shared utility function banner section (optional)
%   Customize banners for functions generated in shared location by using the
%   following predefined tokens: %<FunctionName>, %<FunctionDescription>,
%   %<Arguments>, %<ReturnType>.
%
<SharedUtilityBanner style="classic">
%<FunctionDescription>
</SharedUtilityBanner>

```

Summary of Tokens for Shared Utility Function Banner Generation

FunctionName	Name of function
Arguments	List of function arguments
ReturnType	Return type of function
FunctionDescription	Short abstract about function

File Trailer. The file trailer section contains comments for generating a custom file trailer. The file trailer follows C or C++ code generated from the model. If you omit the file trailer section from the CGT file, no file trailer emits to the generated code. The following section is the default file trailer provided in the default CGT file.

```

%%%%%%%%%%%%%%%%%%%%%%%%%%%%%%%%%%%%%%%%%%%%%%%%%%%%%%%%%%%%%%%%%%%%%%%%
%% Custom file trailer section (optional)
%%
<FileTrailer style="classic">
File trailer for generated code.

[EOF]
</FileTrailer>

```

Tokens available for the file banner are available for the file trailer. See Summary of Tokens for File Banner Generation on page 15-60.

Template Symbols and Rules

Introduction

“Template Symbol Groups” on page 15-64 and “Template Symbols” on page 15-66 describe MPF template symbols and rules for using them. The location of a symbol in one of the supplied template files (`code_c_template.cgt`, `code_h_template.cgt`, `data_c_template.cgt`, or `data_h_template.cgt`) determines where the items associated with that symbol are located in the corresponding generated file. “Template Symbol Groups” on page 15-64 identifies the symbol groups, starting with the parent (“Base”) group, followed by the children of each parent. “Template Symbols” on page 15-66 lists the symbols alphabetically.

Template Symbol Groups

Symbol Group	Symbol Names in This Group
Base (Parents)	Declarations Defines Definitions Documentation Enums Functions Includes Types
Declarations	ExternalCalibrationLookup1D ExternalCalibrationLookup2D ExternalCalibrationScalar ExternalVariableScalar
Defines	LocalDefines LocalMacros
Definitions	FilescopeCalibrationLookup1D FilescopeCalibrationLookup2D FilescopeCalibrationScalar FilescopeVariableScalar GlobalCalibrationLookup1D GlobalCalibrationLookup2D GlobalCalibrationScalar GlobalVariableScalar

Symbol Group	Symbol Names in This Group
Documentation	Abstract Banner Created Creator Date Description FileName History LastModifiedDate LastModifiedBy ModelName ModelVersion ModifiedBy ModifiedComment ModifiedDate ModifiedHistory
	Notes ToolVersion
Functions	CFunctionCode
Types	This parent has no children.

Template Symbols

Symbol Name*	Symbol Group	Symbol Scope	Symbol Description (What the symbol puts in the generated file)
Abstract	Documentation	N/A	User-supplied description of the model or file. Placed in the generated file based on the Stateflow note, Simulink annotation, or DocBlock on the model.**
Banner	Documentation	N/A	Comments located near top of the file. Contains information that includes model and software versions, and date file was generated.
CFunctionCode	Functions	File	C/C++ functions. Must be at the bottom of the template.
Created	Documentation	N/A	Date when model was created. From Created on field on Model Properties dialog box.
Creator	Documentation	N/A	User who created model. From Created by field on Model Properties dialog box.
Date	Documentation	N/A	Date file was generated. Taken from computer clock.
Declarations	Base		Data declaration of a signal or parameter. For example, <code>extern real_T globalvar;</code>
Defines	Base	File	Required <code>#defines</code> of <code>.h</code> files.
Definitions	Base	File	Data definitions of signals or parameters.
Description	Documentation	N/A	Description of model. From Model description field on Model Properties dialog box.**

Symbol Name*	Symbol Group	Symbol Scope	Symbol Description (What the symbol puts in the generated file)
Documentation	Base	N/A	Comments about how to interpret the generated files.
Enums	Base	File	Enumerated data type definitions.
ExternalCalibrationLookup1D	Declarations	External	***
ExternalCalibrationLookup2D	Declarations	External	***
ExternalCalibrationScalar	Declarations	External	***
ExternalVariableScalar	Declarations	External	***
FileName	Documentation	N/A	Name of the generated file.
FilescopeCalibrationLookup1D	Definitions	File	***
FilescopeCalibrationLookup2D	Definitions	File	***
FilescopeCalibrationScalar	Definitions	File	***
FilescopeVariableScalar	Definitions	File	***
Functions	Base	File	Generated function code.
GlobalCalibrationLookup1D	Definitions	Global	***
GlobalCalibrationLookup2D	Definitions	Global	***
GlobalCalibrationScalar	Definitions	Global	***
GlobalVariableScalar	Definitions	Global	***
History	Documentation	N/A	User-supplied revision history of the generated files. Placed in the generated file based on the Stateflow note, Simulink annotation, or DocBlock on the model.**
Includes	Base	File	#include preprocessor directives.

Symbol Name*	Symbol Group	Symbol Scope	Symbol Description (What the symbol puts in the generated file)
LastModifiedDate	Documentation	N/A	Date when model was last saved. From Last saved on field on Model Properties dialog box.
LastModifiedBy	Documentation	N/A	User who last saved model. From Last saved by field on Model Properties dialog box.
LocalDefines	Defines	File	#define preprocessor directives from code-generation data dictionary.
LocalMacros	Defines	File	C/C++ macros local to the file.
ModelName	Documentation	N/A	Name of the model.
ModelVersion	Documentation	N/A	Version number of the Simulink model.
ModifiedBy	Documentation	N/A	Name of user who last modified the model. From Model version field on Model Properties dialog box.
ModifiedComment	Documentation	N/A	Comment user enters in the Modified Comment field on the Log Change dialog box. For more information, see “Log Comments History”.
ModifiedDate	Documentation	N/A	Date model was last modified before code was generated.
ModifiedHistory	Documentation	N/A	Text from Modified history field on Model Properties dialog box.**

Symbol Name*	Symbol Group	Symbol Scope	Symbol Description (What the symbol puts in the generated file)
Notes	Documentation	N/A	User-supplied miscellaneous notes about the model or generated files. Placed in the generated file based on the Stateflow note, Simulink annotation, or DocBlock on the model.**
ToolVersion	Documentation	N/A	A list of the versions of the toolboxes used in generating the code.
Types	Base		Data types of generated code.

* Symbol names must be enclosed between %< >. For example, %<Functions>.

** This symbol can be used to add a comment to the generated files. See “Add Global Comments” on page 15-6. The code generator places the comment in each generated file whose template has this symbol name. The code generator places the comment at the location that corresponds to where the symbol name is located in the template file.

*** The description can be deduced from the symbol name. For example, GlobalCalibrationScalar is a symbol that identifies a scalar. It contains data of global scope that you can calibrate .

Rules for Modifying or Creating a Template

The following are the rules for creating a MPF template. “Comparison of a Template and Its Generated File” on page 15-48 illustrates several of these rules.

- 1** Place a symbol on a template within the `%< >` delimiter. For example, the symbol named `Includes` should look like this on a template: `%<Includes>`.
Note that symbol names are case sensitive.
- 2** Place a symbol on a template where desired. Its location on the template determines where the item associated with this symbol is located in the generated file. If no item is associated with it, the symbol is ignored.
- 3** Place a C/C++ statement outside of the `%< >` delimiter, and on a different line than a `%< >` delimiter, for that statement to appear in the generated file. For example, `#pragma message ("my text")` in the template results in `#pragma message ("my text")` at the corresponding location in the generated file. Note that the statement must be compatible with your C/C++ compiler.
- 4** Use the `.cgt` extension for every template filename. ("`cgt`" stands for code generation template.)
- 5** Note that `%% $Revision: 1.1.4.10.4.1 $` appears at the top of the MathWorks supplied templates. This is for internal MathWorks use only. It does not need to be placed on a user-defined template and does not show in a generated file.
- 6** Place a comment on the template between `/* */` as in standard ANSI C⁶. This results in `/*comment*/` on the generated file.
- 7** Each MPF template must have all of the Base group symbols, in predefined order. They are listed in “Template Symbol Groups” on page 15-64. Each symbol in the Base group is a parent. For example, `Declarations` is a parent symbol.
- 8** Each symbol in a non-Base group is a child. For example, `LocalMacros` is a child.

6. ANSI[®] is a registered trademark of the American National Standards Institute, Inc.

- 9** Except for Documentation children, children must be placed after their parent, before the next parent, and before the `FUNCTIONS` symbol.
- 10** Documentation children can be located before or after their parent in any order anywhere in the template.
- 11** If a non-Documentation child is missing from the template, the code generator places the information associated with this child at its parent location in the generated file.
- 12** If a Documentation child is missing from the template, the code generator omits the information associated with that child from the generated file.

Code Annotation for Justifying Polyspace Checks

With the Polyspace® Model Link™ SL product you can apply Polyspace verification to Embedded Coder generated code. The software detects run-time errors in the generated code and helps you to locate and fix model faults.

Polyspace might highlight overflows for certain operations that are legitimate because of the way Embedded Coder implements these operations. Consider the following model and the corresponding generated code.

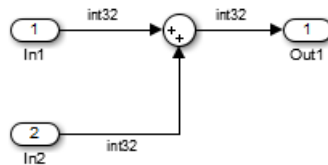

```

32 /* Sum: '<Root>/Sum' incorporates:
33  * Inport: '<Root>/In1'
34  * Inport: '<Root>/In2'
35  */
36 qY_0 = sat_add_U.In1 + sat_add_U.In2;
37 if ((sat_add_U.In1 < 0) && ((sat_add_U.In2 < 0) && (qY_0 >= 0))) {
38     qY_0 = MIN_int32_T;
39 } else {
40     if ((sat_add_U.In1 > 0) && ((sat_add_U.In2 > 0) && (qY_0 <= 0))) {
41         qY_0 = MAX_int32_T;
42     }
43 }

```

Embedded Coder software recognizes that the largest built-in data type is 32-bit. It is not possible to saturate the results of the additions and subtractions using MIN_INT32 and MAX_INT32 and a bigger single-word integer data type. Instead the software detects the results overflow and the direction of the overflow, and saturates the result.

If you do not provide justification for the addition operator on line 36, a Polyspace verification generates an orange check that indicates a potential overflow. The verification does not take into account the saturation function of lines 37 to 43. In addition, the trace-back functionality of Polyspace Model Link SL does not identify the reason for the orange check.

To justify overflows from operators that are legitimate, on the **Configuration Parameters > Code Generation > Comments** pane:

- Under **Overall control**, select the **Include comments** check box.
- Under **Auto generate comments**, select the **Operator annotations check box**.

When you generate code, the Embedded Coder software annotates the code with comments for Polyspace. For example:

```
32 /* Sum: '<Root>/Sum' incorporates:
33  * Inport: '<Root>/In1'
34  * Inport: '<Root>/In2'
35  */
36 qY_0 = sat_add_U.In1 +/*MW:0vOk*/ sat_add_U.In2;
```

When you run a verification using Polyspace Model Link SL, the Polyspace software uses the annotations to justify the operator-related orange checks and assigns the `Not a defect` classification to the checks.

Manage Placement of Data Definitions and Declarations

In this section...

“Overview of Data Placement” on page 15-74

“Priority and Usage” on page 15-75

“Ownership Settings” on page 15-81

“Memory Section Settings” on page 15-81

“Data Placement Rules” on page 15-81

“Settings for a Data Object” on page 15-82

“Data Placement Rules and Results” on page 15-91

Overview of Data Placement

This chapter focuses on module packaging features (MPF) settings that are interdependent. Their combined values, along with Simulink partitioning, determine the file placement of data definitions and declarations, or *data placement*. This includes

- The number of files generated.
- Whether or not the generated files contain definitions for a model’s global identifiers. And, if a definition exists, the settings determine the files in which MPF places them.
- Where MPF places global data declarations (*extern*).

The following six MPF settings are distributed among the main procedures and form an important interdependency:

- The **Data definition** field on the **Code Placement** pane of the Configuration Parameters dialog box.
- The **Data declaration** field on the **Code Placement** pane of the Configuration Parameters dialog box.
- The **Owner** field of the data object in the Model Explorer and the checkbox for **Use owner from data object for data definition placement** on the

Code Placement pane of the Configuration Parameters dialog box. The term "ownership settings" refers to these fields together.

- The **Definition file** field of the data object on the Model Explorer.
- The **Header file** field of the data object on the Model Explorer.
- The **Memory section** field of the data object on the Model Explorer.

Priority and Usage

- “Overview” on page 15-75
- “Read-Write Priority” on page 15-76
- “Global Priority” on page 15-79
- “Definition File, Header File, and Ownership Priorities” on page 15-80

Overview

There is a priority order among interdependent MPF settings. From highest to lowest, the priorities are

- Definition File priority
- Header File priority
- Ownership priority
- Read-Write priority or Global priority

Priority order varies inversely with frequency of use, as illustrated below. For example, Definition File is highest priority but least used.

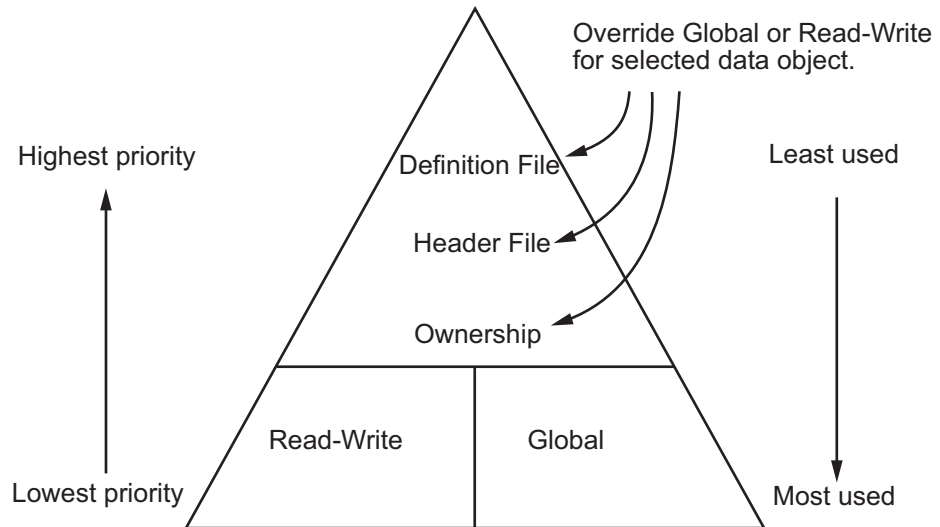

MPF Settings Priority and Usage

Unless they are overridden, the Read-Write and Global priorities place in the generated files all of the model's MPF-derived data objects that you selected using Data Object Wizard. (See "Create Data Objects with Data Object Wizard" on page 8-57 for details.) Before generating the files, you can use the higher priority Definition file, Header file, and Ownership, as desired, to override Read-Write or Global priorities for single data objects. Most users will employ Read-Write or Global, without an override. A few users, however, will want to do an override for certain data objects. We expect that those users whose applications include multiple modules will want to use the Ownership priority.

The priorities are used only for those data objects that are derived from `Simulink.Signal` and `Simulink.Parameter`, and whose custom storage classes are specified using the Custom Storage Class Designer. (For details, see "Design Custom Storage Classes and Memory Sections" on page 10-8.) Otherwise, the build process determines the data placement.

Read-Write Priority

This is the lowest priority. Consider that a model consists of one or more Simulink blocks or Stateflow diagrams. There can be subsystems within

these. For the purpose of illustration, think of a model with one top-level block called `fuelsys`. You double-clicked the block and now see three subsystems labeled `subsys1`, `subsys2` and `subsys3`, as shown in the next figure. Signals `a` and `b` are outputs from the top-level block (`fuelsys`). Signal `a` is an input to `subsys1` and `b` is input to `subsys2`. Signal `c` is an output from `subsys1`. Notice the other inputs and outputs (`d` and `e`). Signals `a` through `e` have corresponding data objects and are part of the code generation data dictionary.

As explained in “Data Definition and Declaration Management” on page 8-55, MPF provides you with the means of selecting a data object that you want defined as an identifier in the generated code. MPF also allows you to specify property values for each data object. For this illustration, we choose to include all of the data objects to be in the dictionary.

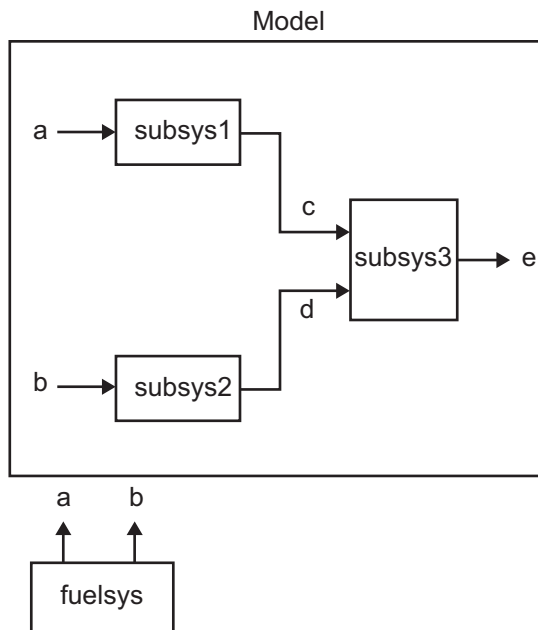

The Generated Files. We generate code for this model. As shown in the figure below, this results in a .c source file corresponding to each of the subsystems. (In actual applications, there could be more than one .c source file for a subsystem. This is based on the file partitioning previously selected for the model. But for our illustration, we only need to show one for each subsystem.) Data objects a through e have corresponding identifiers in the generated files.

A .c source file has one or more functions in it, depending on the internal operations (functions) of its corresponding subsystem. An identifier in a generated .c file has local scope when it is used only in one function of that .c file. An identifier has file scope when more than one function in the same .c file uses it. An identifier has global scope when more than one of the generated files uses it.

A subsystem's source file contains the definitions for that subsystem's data objects that have local scope or file scope. (These definitions are not shown in the figure.) But where are the definitions and declarations for data objects of global scope? These are shown in the next figure.

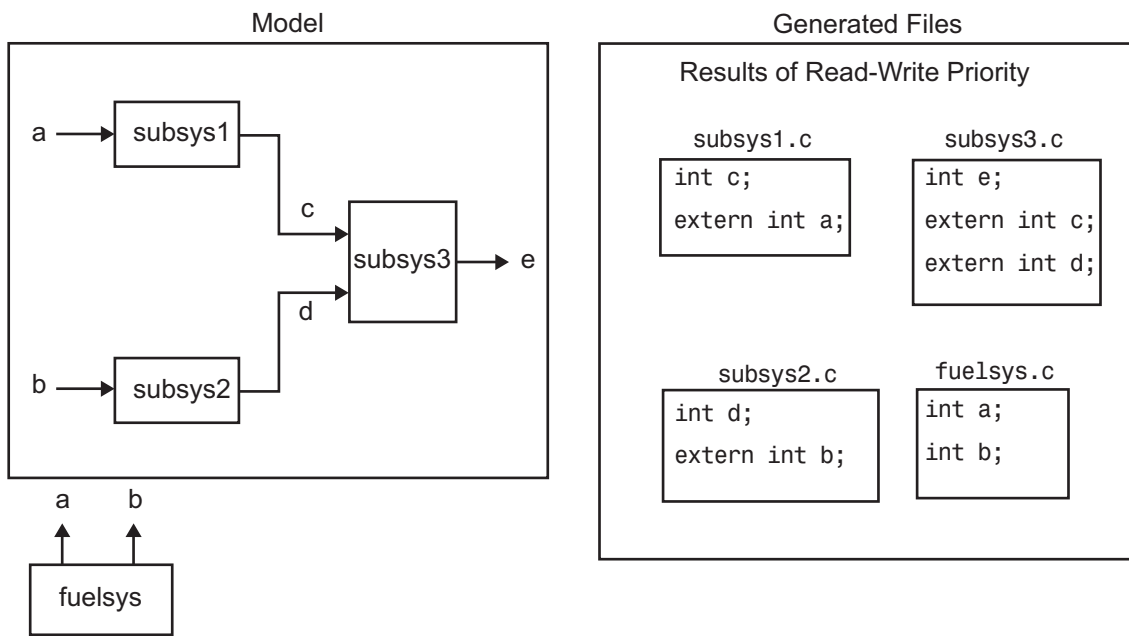

For the Read-Write priority, this source file contains the definitions for the subsystem's global data objects, if this is the file that first writes to the data object's address. Other files that read (use) that data object only include a reference to it. This is why this priority is called Read-Write. Since a read and a write of a file are analogous to input and output of a model's block, respectively, there is another way of saying this. The definitions of a block's global data objects are located in the corresponding generated file, if that data object is an output from that block. The declarations (`extern`) of a block's global data objects are located in the corresponding generated file, if that data object is an input to that block.

Settings for Read-Write Priority. The generated files and what they include, as just described, occur when the Read-Write priority is used. For this to be the case, the other priorities are turned off. That is,

- The **Data definition** field on the **Code Placement** pane is set to Data defined in source file.
- The **Data declaration** field on the **Code Placement** pane is set to Data declared in source file.
- The **Owner** field on the Model Explorer is blank, and the checkbox for the **Use owner from data object for data definition placement** field on the **Code Placement** pane is not checked.
- **Definition file** and **Header file** on the Model Explorer are blank.

Global Priority

This has the same priority as Read-Write (the lowest) priority. The settings for this are the same as for Read-Write Priority, except

- The **Data definition** field on the **Code Placement** pane is set to Data defined in single separate source file.
- The **Data declaration** field on the **Code Placement** pane is set to Data declared in single separate header file.

The generated files that result are shown in the next figure. A subsystem's data objects of local or file scope are defined in the `.c` source file where the subsystem's functions are located (not shown). The data objects of global scope are defined in another `.c` file (called `global.c` in the figure). The

declarations for the subsystem's data objects of global scope are placed in a .h file (called `global.h`).

For example, data objects of local and file scope for `subsys1` are defined in `subsys1.c`. Signal `c` in the model is an output of `subsys1` and an input to `subsys2`. So `c` is used by more than one subsystem and thus is a global data object. Because of the global priority, the definition for `c` (`int c;`) is in `global.c`. The declaration for `c` (`extern int c;`) is in `global.h`. Since `subsys2` uses (reads) `c`, `#include "global.h"` is in `subsys2.c`.

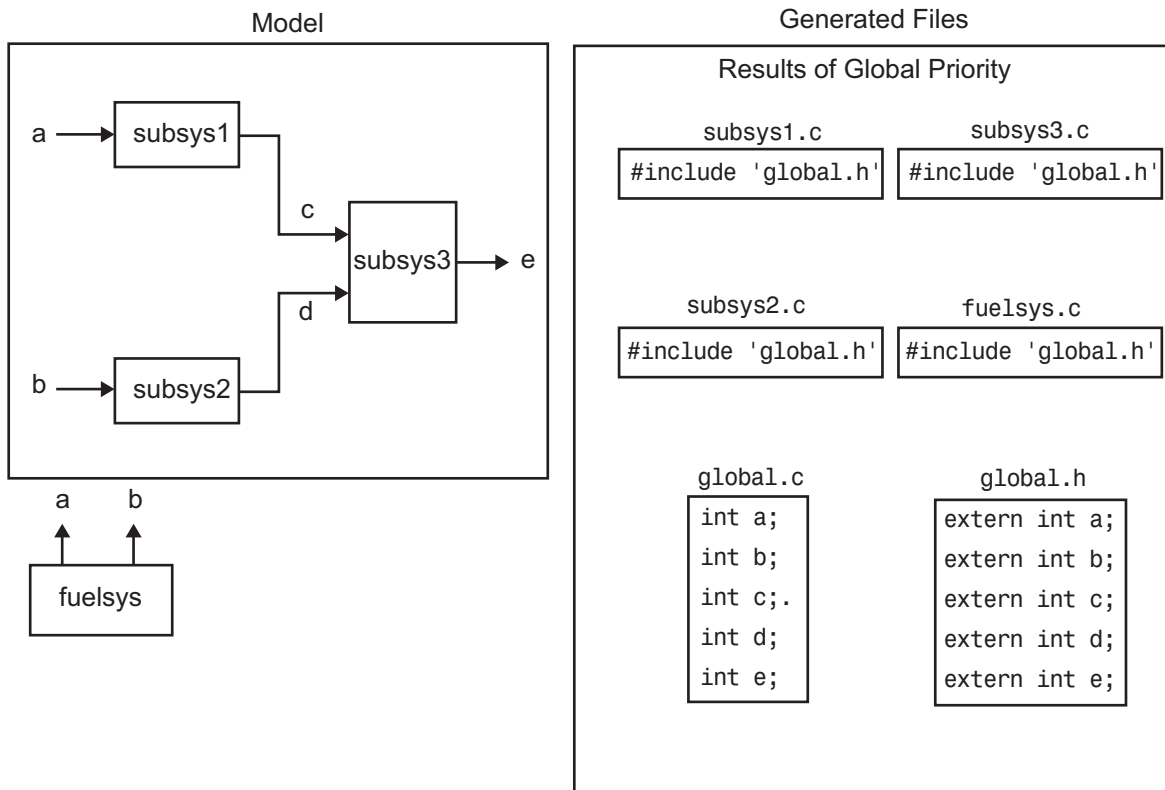

Definition File, Header File, and Ownership Priorities

While the Read-Write and Global priorities operate on all MPF-derived data objects that you want defined in the generated code, the remaining priorities

allow you to override the Read-Write or Global priorities for one or more particular data objects. There is a high-to-low priority among these remaining priorities — Definition File, Header File, and Ownership — for a particular data object, as shown in MPF Settings Priority and Usage on page 15-76

Ownership Settings

Ownership settings refers to the on or off setting specified using the **Use owner from data object for data definition placement** checkbox on the **Code Placement** pane of the Configuration Parameters dialog box, and the **Owner** field of a data object in the Model Explorer. These settings do not control what files are generated. These settings only specify definitions and extern statements. There are four possible configurations, as shown in “Ownership Settings” on page 15-91.

Memory Section Settings

Memory sections allow you to specify storage directives for a data object. As shown in Parameter and Signal Property Values on page 9-3, the possible values for the **Memory section** property of a parameter or signal object are Default, MemConst, MemVolatile or MemConstVolatile.

If you specify a filename for **Definition file**, and select Default, MemConst, MemVolatile or MemConstVolatile for the **Memory section** property, the code generation software generates a `.c` file and an `.h` file. The `.c` file contains the definition for the data object with the `pragma` statement or qualifier associated with the **Memory section** selection. The `.h` file contains the declaration for the data object. The `.h` file can be included, using the preprocessor directive `#include`, in files that need to reference the data object.

You can add more memory sections. For more information, see “Design Custom Storage Classes and Memory Sections” on page 10-8 and “Memory Sections”.

Data Placement Rules

For a complete set of data placement rules in convenient tabular form, based on the priorities discussed in this chapter, see “Data Placement Rules and Results” on page 15-91.

Settings for a Data Object

- “Introduction” on page 15-82
- “Read-Write” on page 15-84
- “Ownership” on page 15-85
- “Header File” on page 15-87
- “Definition File” on page 15-89

Introduction

“Settings and Resulting Generated Files” on page 15-91 provides example settings for one data object of a model. Eight examples are listed so that you can see the generated files that result from a wide variety of settings. Four examples from this table are discussed below in more detail. These discussions provide information for understanding settings you might choose. For illustration purposes, the four examples assume that we are dealing with an overall system that controls engine idle speed.

The next figure shows that the software component of this example system consists of two modules, IAC (Idle Air Control), and IO (Input-Output).

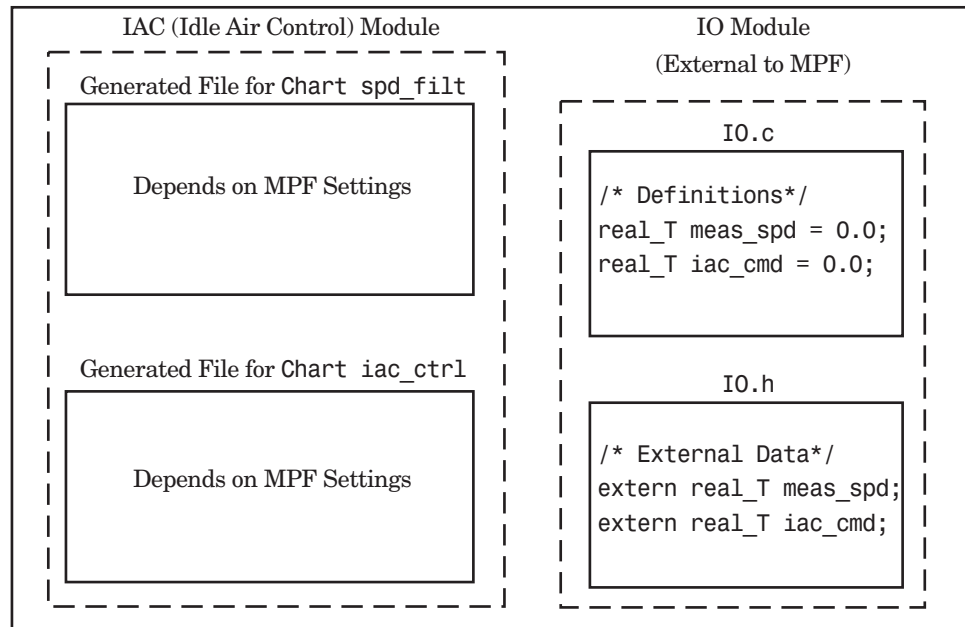

Engine Idle Speed Control System

The code in the IO module controls the system's IO hardware. Code is generated only for the IAC module. (Some other means produced the code for the IO module, such as hand-coding.) So the code in IO is external to MPF, and can illustrate legacy code. To simplify matters, the IO code contains one source file, called `IO.c`, and one header file, called `IO.h`.

The IAC module consists of two Stateflow charts, `spd_filt` and `iac_ctrl`. The `spd_filt` chart has two signals (`meas_spd`) and `filt_spd`, and one parameter (`a`). The `iac_ctrl` chart also has two signals (`filt_spd` and `iac_cmd`) and a parameter (`ref_spd`). (The parameters are not visible in the top-level charts.) One file for each chart is generated. This example system allows us to illustrate referencing from file to file within the MPF module, and model to external module. It also illustrates the case where there is no such referencing.

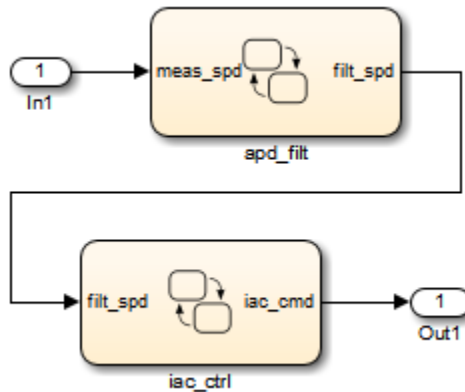

Proceed to the discussion of the desired example settings:

- “Read-Write” on page 15-84
- “Ownership” on page 15-85
- “Header File” on page 15-87
- “Definition File” on page 15-89

Read-Write

These settings and the generated files that result are shown as Example Settings 1 in “Settings and Resulting Generated Files” on page 15-91. As you can see from the table, this example illustrates the case in which only one .c source file (for each chart) is generated.

So, for the IAC model, select the following settings. Accept the Data defined in source file in the **Data definition** field and the Data declared in source file in the **Data declaration** field on the **Code Placement** pane of the Configuration Parameters dialog box. Accept the default unchecked **Use owner from data object for data definition placement** field. Accept the default blank settings for the **Owner**, **Definition file** and **Header file** fields on the Model Explorer. For **Memory section**, accept Default. Now the Read-Write priority is active. Generate code. The next figure shows the results in terms of definition and declaration statements.

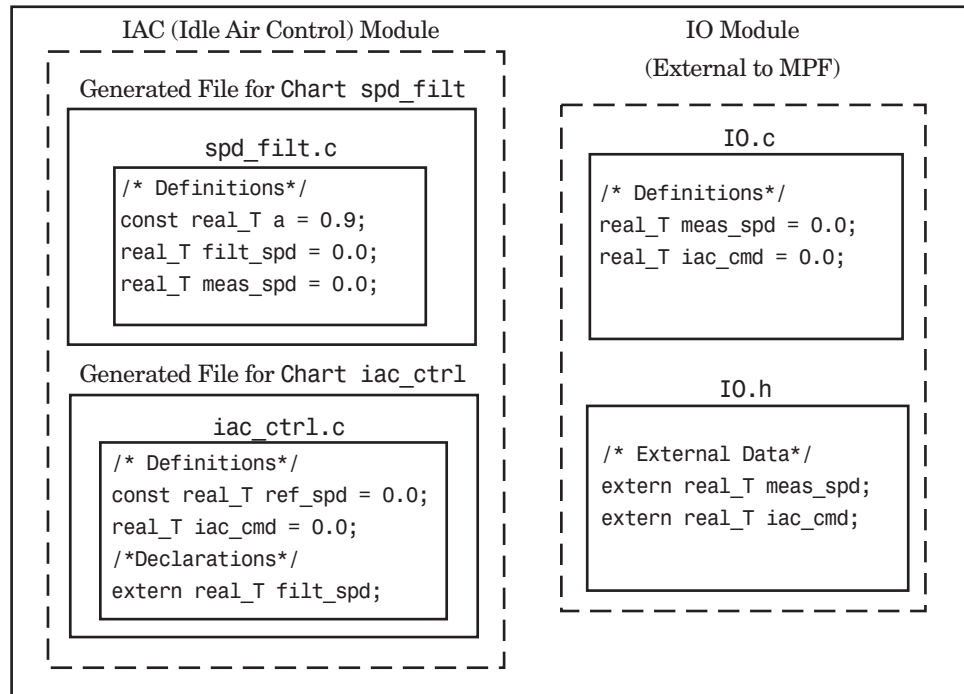

Engine Idle Speed Control System (Read-Write Example)

The code generator generated a `spd_filt.c` for the `spd_filt` chart and `iac_ctrl.c` for the `iac_ctrl` chart. As you can see, MPF placed definitions of data objects for the `spd_filt` chart in `spd_filt.c`. It placed definitions of data objects for the `iac_ctrl` chart in `iac_ctrl.c`.

However, notice `real_T filt_spd`. This data object is defined in `spd_filt.c` and declared in `iac_ctrl.c`. That is, since the Read-Write priority is active, `filt_spd` is defined in the file that first writes to its address. And, it is declared in the file that reads (uses) it. Further, `real_T meas_spd` is defined in both `spd_filt.c` and the external `IO.c`. And, `real_T iac_cmd` is defined in both `iac_ctrl.c` and `IO.c`.

Ownership

See tables “Ownership Settings” on page 15-91 and “Settings and Resulting Generated Files” on page 15-91. In the “Read-Write” on page 15-84, there are

several instances where the same data object is defined in more than one `.c` source file, and there is no declaration (`extern`) statement. This would result in compiler errors during link time. But in this example, we configure MPF Ownership rules so that linking can take place. Notice the Example Settings 2 row in “Settings and Resulting Generated Files” on page 15-91. Except for the ownership settings, assume these are the settings you made for the model in the IAC module. Since this example has no **Definition file** or **Header file** specified, now Ownership takes priority. (If you specified a **Definition file** or **Header file**, MPF ignores the ownership settings.)

On the **Code Placement** pane of the Configuration Parameters dialog box, check the box for the **Use owner from data object for data definition placement** field. Open the Model Explorer (by issuing the MATLAB command `daexplr`) and, for all data objects except `meas_spd` and `iac_cmd`, type IAC in the **Owner** field (case sensitive). Then, only for the `meas_spd` and `iac_cmd` data objects, type IO as their **Owner** (case sensitive). Generate code.

The results are shown in the next figure. Notice the `extern real_T meas_spd` statement in `spd_filt.c`, and `extern real_T iac_cmd` in `iac_ctrl.c`. MPF placed these declaration statements in the files where these data objects are used. This allows the generated source files (`spd_filt.c` and `iac_ctrl.c`) to be compiled and linked with `IO.c`.

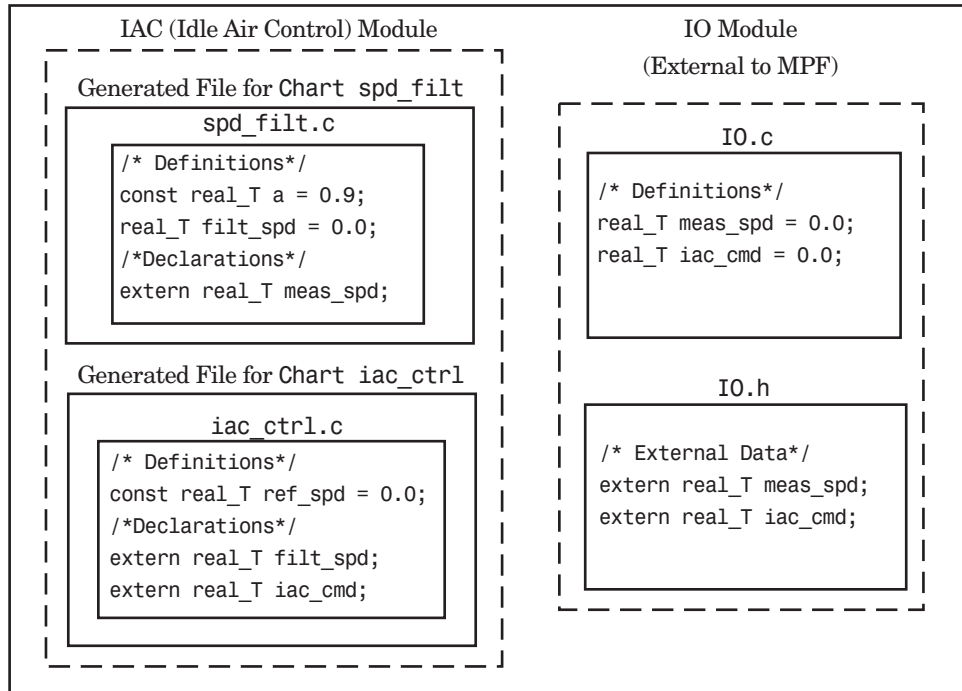

Engine Idle Speed Control System (Ownership Example)

Header File

These settings and the generated files that result are shown as Example Settings 3 in “Settings and Resulting Generated Files” on page 15-91. This example has no **Definition file** specified. If you specified a **Definition file**, MPF ignores the **Header file** setting. The focus of this example is to show how the **Header file** settings result in the linking of the two chart source files to the external IO files, shown in the next figure. (Also, ownership settings will be used to link the two chart files with each other.)

As you can see in the figure, the `meas_spd` and `iac_cmd` identifiers are defined in `IO.c` and declared in `IO.h`. Both of these identifiers are external to the generated `.c` files. You open the Model Explorer and select both the `meas_spd` and `iac_cmd` data objects. For each of these data objects, in the **Header file** field, specify `IO.h`, since this is where these two objects are declared. This setting allows the `spd_filt.c` source file to compile and link with the external `IO.c` file.

Now we configure the ownership settings. In the Model Explorer, select the `filt_spd` data object and set its **Owner** field to `IAC`. Then, on the **Code Placement** pane of the Configuration Parameters dialog box, check the box for the **Use owner from data object for data definition placement** field. Now the `spd_filt` source file links to the `iac_ctrl` source file. Generate code. See the figure below.

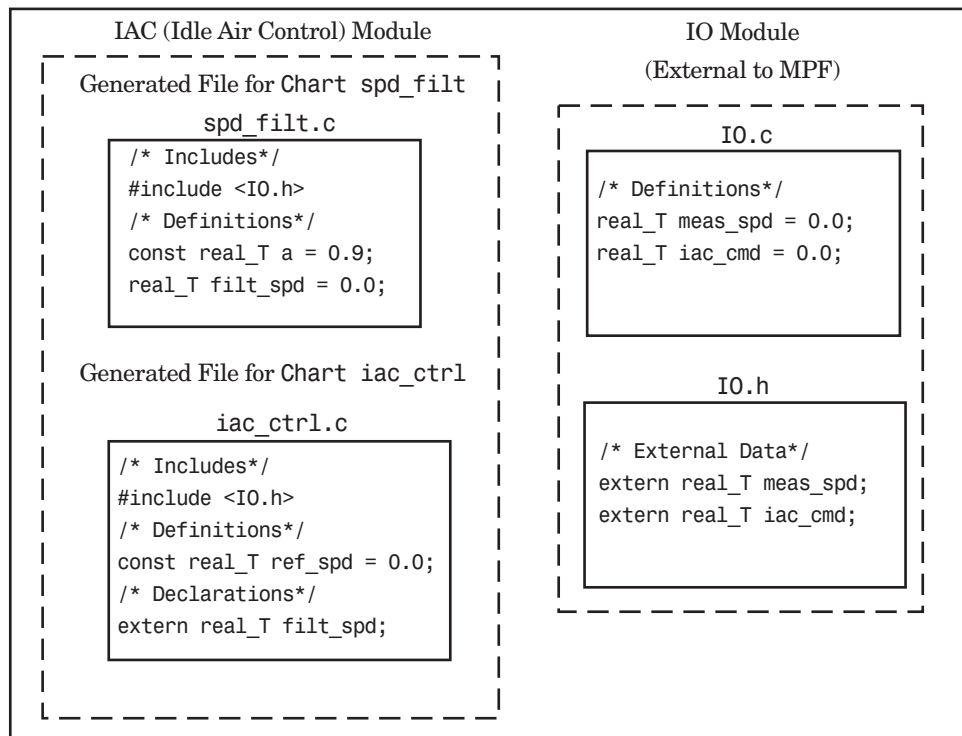

Engine Idle Speed Control System (Header File Example)

Since you specified the `IO.h` filename for the **Header file** field for the `meas_spd` and `iac_ctrl` objects, the code generator assumed that their declarations are in `IO.h`. So the code generator placed `#include IO.h` in each source file: `spd_filt.c` and `iac_ctrl.c`. So these two files will link with the external IO files. Also, due to the ownership settings that were specified, the code generator places the `real_T filt_spd = 0.0;` definition in `spd_filt.c` and declares the `filt_spd` identifier in `iac_ctrl.c` with `extern real_T iac_cmd;`. Consequently, the two source files will link together.

Definition File

These settings and the generated files that result are shown as Example Settings 4 in “Settings and Resulting Generated Files” on page 15-91. Notice that a definition filename is specified. The settings in the table only apply to the data object called `a`. You have decided that you do not want this object defined in `spd_filt.c`, the generated source file for the `spd_filt` chart. (There are many possible organizational reasons one might want an object declared in another file. It is not important for this example to specify the reason.)

For this example, assume the settings for all data objects are the same as those indicated in “Header File” on page 15-87, except for the data object `a`. The description below identifies only the differences that result from this.

Open the Model Explorer, and select data object `a`. In the **Definition file** field specify a filename. Choose `filter_constants.c`. Generate code. The results are shown in the next figure.

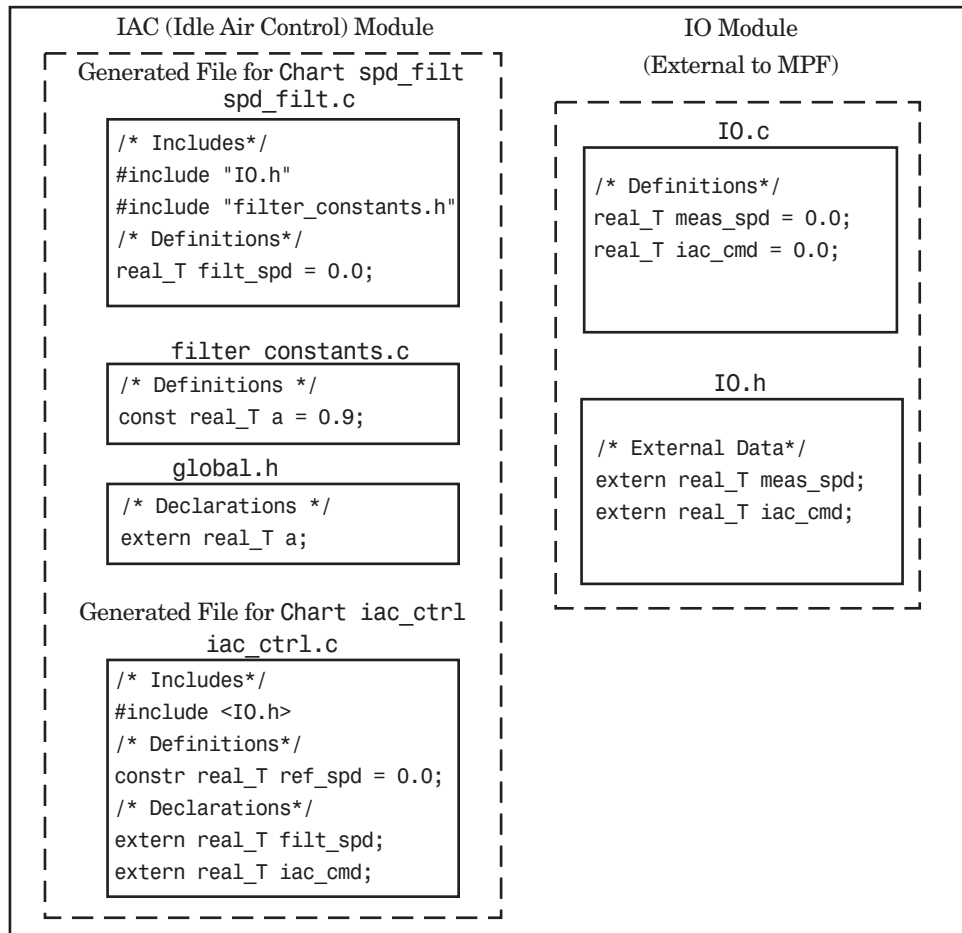

Engine Idle Speed Control System (Definition File Example)

The code generator generates the same files as in the “Header File” on page 15-87, and adds a new file, `filter_constants.c`. Data object `a` now is defined in `filter_constants.c`, rather than in the source file `spd_filt.c`, as it is in the example. This data object is declared with an `extern` statement in `global.h`.

Data Placement Rules and Results

- “Ownership Settings” on page 15-91
- “Settings and Resulting Generated Files” on page 15-91
- “Data Placement Rules” on page 15-94

Ownership Settings

Row Number	Enable Data Ownership Checkbox	Owner Setting	Result*
1	Off**	Blank**	Embedded Coder determines whether the current model defines data.
2	Off**	A name is specified.	Embedded Coder determines whether the current model defines data.
3	On	Blank**	Embedded Coder determines whether the current model defines data.
4	On	A name is specified.	The model specified in the Owner setting defines data.

* See also “Ownership Settings” on page 15-81.

** Default.

Settings and Resulting Generated Files

	Data Defined In...	Data Declared In...	Ownership*	Defined File**	Header File	Generated Files
Example Settings 1	Source file	Source file	Blank	Blank	Blank	.c / .cpp source file

	Data Defined In...	Data Declared In...	Ownership*	Defined File**	Header File	Generated Files
(Rd-Write Example)						
Example Settings 2 (Ownership Example)	Source file	Source file	Name of module specified	Blank	Blank	.c/.cpp source file
Example Settings 3 (Header File Example)	Source file	Source file	Blank	Blank	Desired include filename specified.	.c/.cpp source file .h definition file
Example Settings 4 (Def. File Example)	Source file	Source file	Blank	Desired definition filename specified.	Desired include filename specified.	.c/.cpp source file .c/.cpp definition file* .h definition file*
Example Settings 5	Single separate source file	Source file	Blank	Blank	Blank	.c/.cpp source file global .c/.cpp
Example Settings 6	Single separate source file	Single separate header file	Blank	Blank	Blank	.c/.cpp source file global .c/.cpp global.h
Example Settings 7	Single separate source file	Single separate header file	Name of module specified	Blank	Blank	.c/.cpp source file global.c/.cpp global.h
Example Settings 8	Single separate source file	Single separate header file	Blank	Blank	Desired include filename specified.	.c/.cpp source file global.c/.cpp global.h .h definition file

* "Blank" in ownership setting means that the check box for the **Use owner from data object for data definition placement** field on the **Code Placement** pane is **Off** and the **Owner** field on the Model Explorer is blank. "Name of module specified" can be a variety of ownership settings as defined in "Ownership Settings" on page 15-91.

** The code generator generates a definition `.c/.cpp` file for every data object for which you specified a definition filename (unless you selected `#DEFINE` for the **Memory section** field). For example, if you specify the same definition filename for all data objects, only one definition `.c/.cpp` file is generated. The code generator places declarations in `model.h` by default, unless you specify **Data declared in single separate header file** for the **Data declaration** option on the **Code Generation > Code Placement** pane of the Configuration Parameter dialog box. If you select that data placement option, the code generator places declarations in `global.h`. If you specify a definition filename for each data object, the code generator generates one definition `.c/.cpp` file for each data object and places declarations in `model.h` by default, unless you specify **Data declared in single separate header file** for **Data declaration**. If you select that data placement option, the code generator places declarations in `global.h`.

Note If you generate C++ rather than C code, the .c files listed in the following table will be .cpp files.

Data Placement Rules

Storage Class Setting	Global Settings:		Override Settings for Specific Data Object:			Results in Generated Files:		
	Data Def.	Data Dec.	Def. File	Owner	Header File	Where Data Def. Is	Where Data Dec. Is	Dec. Inclusion
<i>mpt or Simulink Noncustom Storage Classes:</i>								
auto	N/A	N/A	N/A	N/A	N/A	Note 12	model.h	Note 1
Exported-Global	N/A	N/A	N/A	N/A	N/A	model.c	model.h	Note 1
Imported-- Extern, Imported-- Extern-Pointer	N/A	N/A	N/A	N/A	N/A	None. External	model_ private.h	Note 2
Simulink-Global	N/A	N/A	N/A	N/A	N/A	Note 13	model.h	Note 1
<i>mpt or Simulink Custom Storage Class: Imported Data:</i>								
Imported-- FromFile	D/C	D/C	D/C	N/A	null	None	model_ private.h	Note 3
Imported-- FromFile	D/C	D/C	D/C	N/A	hdr.h	None	model_ private.h	Note 4
<i>Simulink Custom Storage Class: #define Data:</i>								
Define	D/C	D/C	N/A	N/A	N/A	N/A	#define, model.h	Note 5
<i>mpt Custom Storage Class: #define Data:</i>								
Define	D/C	D/C	N/A	N/A	null	N/A	#define, model.h	Note 5
Define	D/C	D/C	N/A	N/A	hdr.h	N/A	#define, model.h	Note 6
<i>mpt or Simulink Custom Storage Class: GetSet:</i>								
GetSet	D/C	D/C	N/A	N/A	hdr.h	N/A	External hdr.h	Note 4

Storage Class Setting	Global Settings:		Override Settings for Specific Data Object:			Results in Generated Files:		
	Data Def.	Data Dec.	Def. File	Owner	Header File	Where Data Def. Is	Where Data Dec. Is	Dec. Inclusion
<i>mpt or Simulink Custom Storage Class: Bitfield, Struct:</i>								
Bitfield, Struct	D/C	D/C	N/A	N/A	N/A	model.c	model.h	Note 7
<i>mpt Custom Storage Class: Global, Const, ConstVolatile, Volatile:</i>								
Global, Const, Const-Volatile, Volatile	auto	auto	null	null or locally owned	null	model.c	model.h	Note 1
Global, Const, Const-Volatile, Volatile	src	auto	null	null or locally owned	null	src.c	model.h	Note 1
Global, Const, Const-Volatile, Volatile	sep	auto	null	null or locally owned	null	gbl.c	model.h	Note 1
Global, Const, Const-Volatile, Volatile	auto	src	null	null or locally owned	null	model.c	src.c	Note 8
Global, Const, Const-Volatile, Volatile	src	src	null	null or locally owned	null	src.c	src.c	Note 8
Global, Const, Const-Volatile, Volatile	sep	src	null	null or locally owned	null	gbl.c	src.c	Note 8
Global, Const, Const-Volatile, Volatile	auto	sep	null	null or locally owned	null	model.c	gbl.h	Note 9
Global, Const, Const-Volatile, Volatile	src	sep	null	null or locally owned	null	src.c	gbl.h	Note 9
Global, Const, Const-Volatile, Volatile	sep	sep	null	null or locally owned	null	gbl.c	gbl.h	Note 9
Global, Const, Const-Volatile, Volatile	D/C	D/C	data.c	D/C	null	data.c	See Note 10.	Note 10

Storage Class Setting	Global Settings:		Override Settings for Specific Data Object:			Results in Generated Files:		
	Data Def.	Data Dec.	Def. File	Owner	Header File	Where Data Def. Is	Where Data Dec. Is	Dec. Inclusion
Global, Const, Const-Volatile, Volatile	D/C	D/C	data.c	D/C	hdr.h	data.c	hdr.h	Note 11
Global, Const, Const-Volatile, Volatile	auto	D/C	null	null	hdr.h	model.c	hdr.h	Note 11
Global, Const, Const-Volatile, Volatile	src	D/C	null	null	hdr.h	src.c	hdr.h	Note 11
Global, Const, Const-Volatile, Volatile	sep	D/C	null	null	hdr.h	gbl.c	hdr.h	Note 11
Global, Const, Const-Volatile, Volatile	D/C	auto	null	External owner	null	External user--supplied file	model.h	Note 1
Global, Const, Const-Volatile, Volatile	D/C	src	null	External owner	null	External user--supplied file	src.c	Note 8
Global, Const, Const-Volatile, Volatile	D/C	sep	null	External owner	null	External user--supplied file	gbl.h	Note 9
Global, Const, Const-Volatile, Volatile	D/C	D/C	null	External owner	header.h	External user--supplied file	hdr.h	Note 11
Global, Const, Const-Volatile, Volatile	D/C	D/C	null	External owner	header.h	External user--supplied file	hdr.h	Note 11

mpt Custom Storage Class: Exported Data:

Storage Class Setting	Global Settings:		Override Settings for Specific Data Object:			Results in Generated Files:		
	Data Def.	Data Dec.	Def. File	Owner	Header File	Where Data Def. Is	Where Data Dec. Is	Dec. Inclusion
ExportTo-File	auto	auto	null	null	null	model.c	model.h	Note 1
ExportTo-File	src	auto	null	null	null	src.c	model.h	Note 1
ExportTo-File	sep	auto	null	null	null	gbl.c	model.h	Note 1
ExportTo-File	auto	src	null	null	null	model.c	src.c	Note 8
ExportTo-File	src	src	null	null	null	src.c	src.c	Note 8
ExportTo-File	sep	src	null	null	null	gbl.c	src.c	Note 8
ExportTo-File	auto	sep	null	null	null	model.c	gbl.h	Note 9
ExportTo-File	src	sep	null	null	null	src.c	gbl.h	Note 9
ExportTo-File	sep	sep	null	null	null	gbl.c	gbl.h	Note 9
ExportTo-File	D/C	D/C	data.c	null	null	data.c	See Note 10.	Note 10
ExportTo-File	D/C	D/C	data.c	null	hdr.h	model.c	hdr.h	Note 11
ExportTo-File	auto	D/C	null	null	hdr.h	src.c	hdr.h	Note 11
ExportTo-File	sep	D/C	null	null	hdr.h	gbl.c	hdr.h	Note 11
<i>Simulink Custom Storage Class: Default, Const, ConstVolatile, Volatile:</i>								
Default, Const, Const-Volatile, Volatile	auto	auto	N/A	N/A	N/A	model.c	model.h	Note 1
Default, Const, Const-Volatile, Volatile	src	auto	N/A	N/A	N/A	src.c	model.h	Note 1
Default, Const, Const-Volatile, Volatile	sep	auto	N/A	N/A	N/A	gbl.c	model.h	Note 1
Default, Const, Const-Volatile, Volatile	auto	src	N/A	N/A	N/A	model.c	src.c	Note 8
Default, Const, Const-Volatile, Volatile	src	src	N/A	N/A	N/A	src.c	src.c	Note 8

	Global Settings:		Override Settings for Specific Data Object:			Results in Generated Files:		
Storage Class Setting	Data Def.	Data Dec.	Def. File	Owner	Header File	Where Data Def. Is	Where Data Dec. Is	Dec. Inclusion
Default, Const, Const-Volatile, Volatile	sep	src	N/A	N/A	N/A	gbl.c	src.c	Note 8
Default, Const, Const-Volatile, Volatile	auto	sep	N/A	N/A	N/A	model.c	gbl.h	Note 9
Default, Const, Const-Volatile, Volatile	src	sep	N/A	N/A	N/A	src.c	gbl.h	Note 9
Default, Const, Const-Volatile, Volatile	sep	sep	N/A	N/A	N/A	gbl.c	gbl.h	Note 9
<i>Simulink Custom Storage Class: Exported Data:</i>								
ExportTo-File	auto	auto	N/A	N/A	null	model.c	model.h	Note 1
ExportTo-File	src	auto	N/A	N/A	null	src.c	model.h	Note 1
ExportTo-File	sep	auto	N/A	N/A	null	gbl.c	model.h	Note 1
ExportTo-File	auto	src	N/A	N/A	null	model.c	src.c	Note 8
ExportTo-File	src	src	N/A	N/A	null	src.c	src.c	Note 8
ExportTo-File	sep	src	N/A	N/A	null	gbl.c	src.c	Note 8
ExportTo-File	auto	sep	N/A	N/A	null	model.c	gbl.h	Note 9
ExportTo-File	src	sep	N/A	N/A	null	src.c	gbl.h	Note 9
ExportTo-File	sep	sep	N/A	N/A	null	gbl.c	gbl.h	Note 9
ExportTo-File	auto	D/C	N/A	N/A	hdr.h	model.c	hdr.h	Note 11
ExportTo-File	src	D/C	N/A	N/A	hdr.h	src.c	hdr.h	Note 11
ExportTo-File	sep	D/C	N/A	N/A	hdr.h	gbl.c	hdr.h	Note 11

Notes. In the previous table:

- A Declaration Inclusion Approach is a file in which the header file that contains the data declarations is included.

- D/C stands for don't care.
- Dec stands for declaration.
- Def stands for definition.
- gbl stands for global.
- hdr stands for header.
- N/A stands for not applicable.
- null stands for field is blank.
- sep stands for separate.

Note 1: `model.h` is included directly in all source files.

Note 2: `model_private.h` is included directly in all source files.

Note 3: `extern` is included in `model_private.h`, which is in `source.c`.

Note 4: `header.h` is included in `model_private.h`, which is in `source.c`.

Note 5: `model.h` is included directly in all source files that use `#define`.

Note 6: `header.h` is included in `model.h`, which is in source files that use `#define`.

Note 7: `model.h` is included in all `source.c` files.

Note 8: `extern` is inlined in source files where data is used.

Note 9: `global.h` is included in `model.h`, which is in all source files.

Note 10: When you specify a definition filename for a data object, a header file is not generated for that data object. The code generator declares the data object according to the data placement priorities.

Note 11: `header.h` is included in `model.h`, which is in all source files.

Note 12: Signal: Either not defined because it is expression folded, or local data, or defined in a structure in `model.c`, all depending on model's code

generation settings. Parameter: Either inlined in the code, or defined in `model_data.c`.

Note 13: Signal: In a structure that is defined in `model.c`. Parameter: In a structure that is defined in `model_data.c`.

Specify Delimiter for #Includes

Understanding the purpose of this procedure requires understanding the `Header file` property of a data object, described in `Parameter and Signal Property Values` on page 9-3, and applied in “Create mpt Data Objects with Data Object Wizard” on page 8-63. For a particular data object, you can specify as the `Header file` property value a `.h` filename where that data object will be declared. Then, in the `IncludeFile` section of the generated file, this `.h` file is indicated in a `#include` preprocessor directive.

Further, when specifying the filename as the `Header file` property value, you may or may not place it within the double-quote or angle-bracket delimiter. That is, you can specify it as `filename.h`, `"filename.h"`, or `<filename.h>`. The code generator finds every data object for which you specified a filename as its `Header file` property value *without* a delimiter. By default, it assigns to each of these the double-quote delimiter.

This procedure allows you to specify the angle-bracket delimiter for these instead of the default double-quote delimiter. See the figure below.

- 1** In the **#include file delimiter** field on the **Code Placement** pane of the Configuration Parameters dialog box, select `#include <header.h>` instead of the default `#include "header.h"`.
- 2** Click **Apply**.

Source Code Generation

- “Generating Code Using Embedded Coder” on page 16-2
- “Generate Code Modules” on page 16-8
- “Generate Reentrant Code from MATLAB Code” on page 16-14

Generating Code Using Embedded Coder

This example shows how to select a target for a Simulink model, configure options, generate C code for embedded systems, and view generated files.

1. Open the model.

```
model='rtwdemo_rtwecintro';
open_system(model)
```

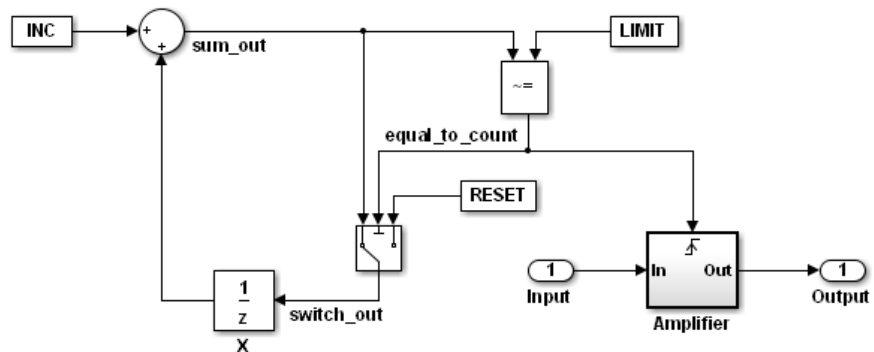

Algorithm Description

An 8-bit counter feeds a triggered subsystem parameterized by constants INC, LIMIT, and RESET. The I/O for the model is Input and Output. The Amplifier subsystem amplifies the input signal by gain factor K, which is updated whenever signal equal to count is true.



Copyright 1994-2012 The MathWorks, Inc.

2. Open the **Configuration Parameters** dialog box from the model editor by clicking **Simulation > Model Configuration Parameters**.

Alternately, type the following commands at the MATLAB command prompt.

```
cs = getActiveConfigSet(model);
openDialog(cs);
```

3. Select the **Code Generation** node.

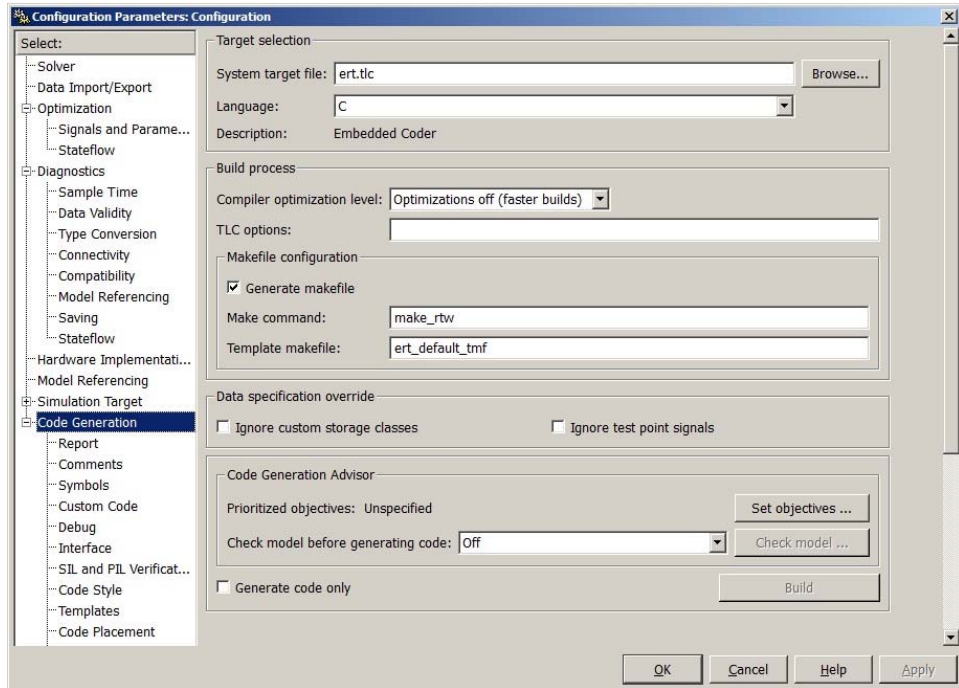

4. In the **Target Selection** pane, click **Browse** to select a target.

You can generate code for a particular target environment or purpose. Some built-in targeting options are provided using system target files, which control the code generation process for a target.

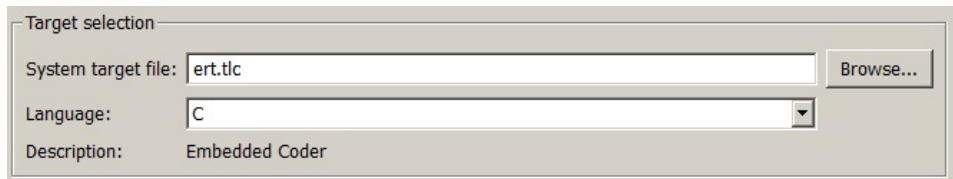

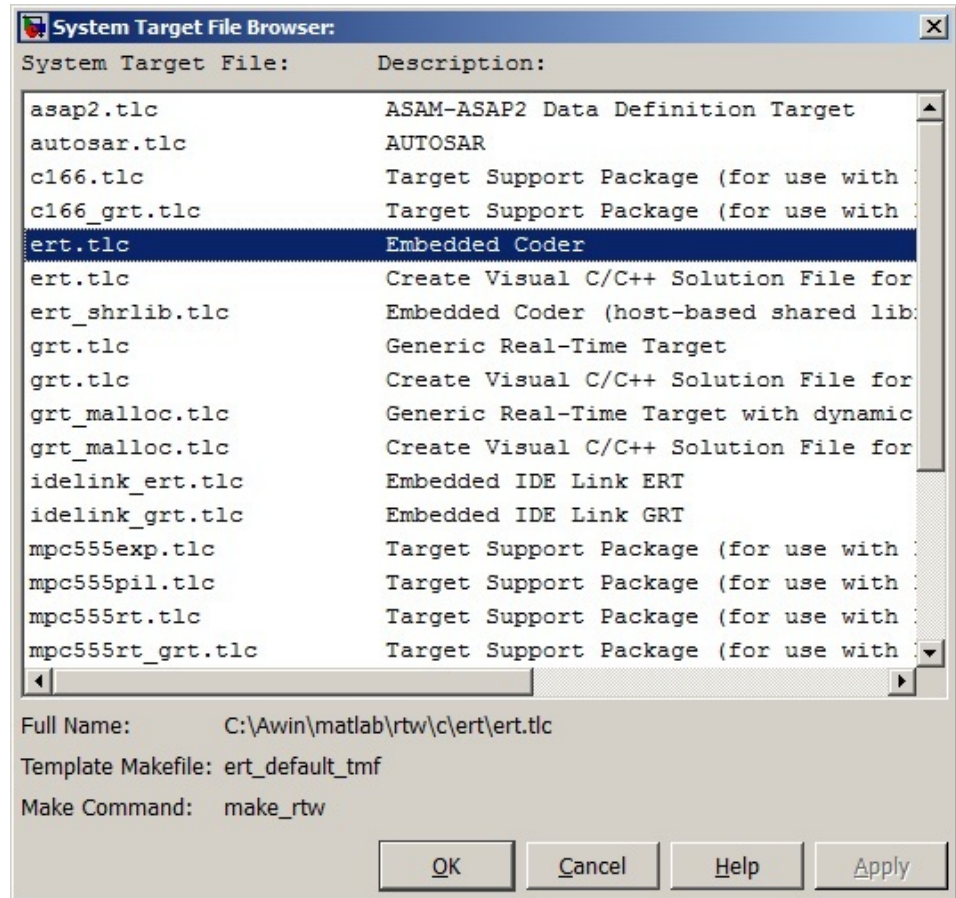

5. Select the **Embedded Real-Time (ERT)** target and click **Apply**.

The ERT target includes a utility to specify and prioritize code generation settings based on your application objectives.

6. In the **Code Generation Advisor** pane, click **Set Objectives**.

You can set and prioritize objectives for the generated code. For example, while code traceability might be a very important criterion for your

application, you might not want to prioritize it at the cost of code execution efficiency.



7. In the **Set Objectives** pane, select **Execution efficiency** and **Traceability**. Click **OK**.

You can select and prioritize a combination of objectives before generating code.

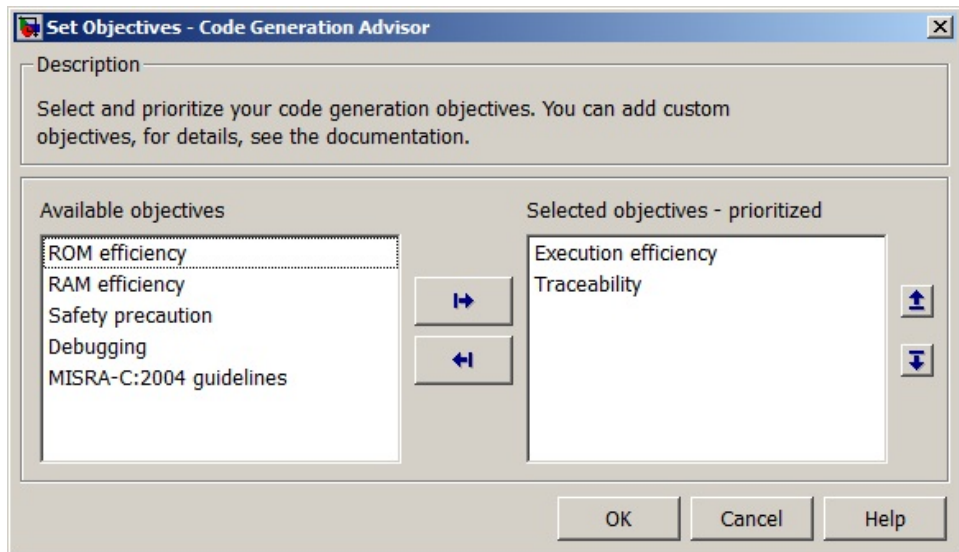

8. In the **Code Generation** pane, click **Build** to generate code.

9. View the code generation report that appears.

The report includes `rtwdemo_rtwecintro.c`, associated utility and header files, and traceability and validation reports.

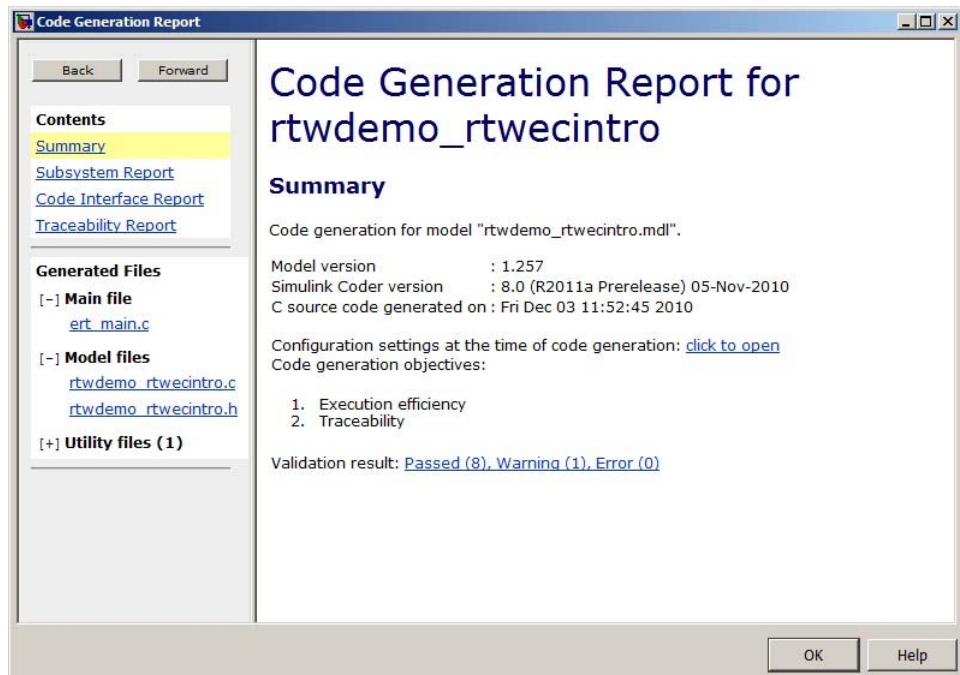

The figure below contains a portion of `rtwdemo_rtwecintro.c`

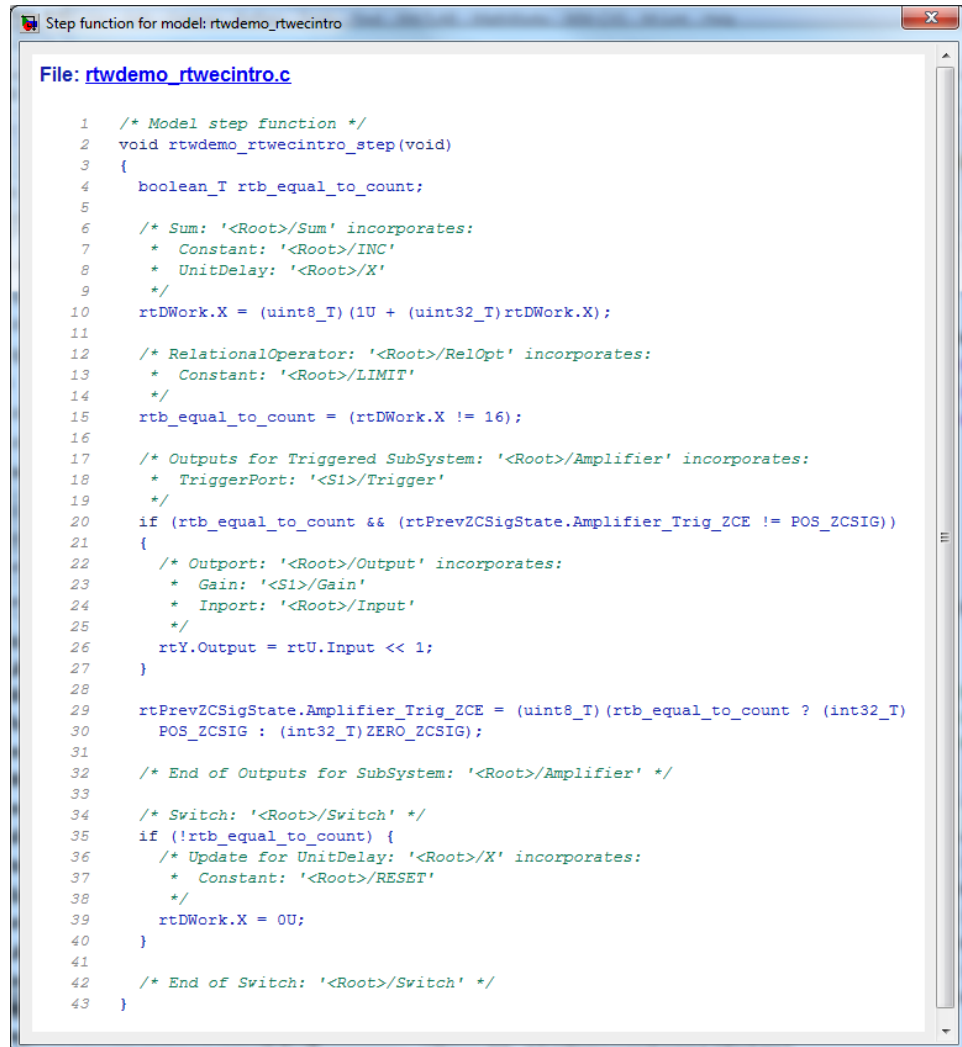

```

Step function for model: rtdemo_rtwecintro

File: rtdemo_rtwecintro.c

1  /* Model step function */
2  void rtdemo_rtwecintro_step(void)
3  {
4      boolean_T rtb_equal_to_count;
5
6      /* Sum: '<Root>/Sum' incorporates:
7       * Constant: '<Root>/INC'
8       * UnitDelay: '<Root>/X'
9       */
10     rtDWork.X = (uint8_T)(1U + (uint32_T)rtDWork.X);
11
12     /* RelationalOperator: '<Root>/RelOpt' incorporates:
13      * Constant: '<Root>/LIMIT'
14      */
15     rtb_equal_to_count = (rtDWork.X != 16);
16
17     /* Outputs for Triggered SubSystem: '<Root>/Amplifier' incorporates:
18      * TriggerPort: '<S1>/Trigger'
19      */
20     if (rtb_equal_to_count && (rtPrevZCSigState.Amplifier_Trig_ZCE != POS_ZCSIG))
21     {
22         /* Output: '<Root>/Output' incorporates:
23          * Gain: '<S1>/Gain'
24          * Inport: '<Root>/Input'
25          */
26         rtY.Output = rtU.Input << 1;
27     }
28
29     rtPrevZCSigState.Amplifier_Trig_ZCE = (uint8_T)(rtb_equal_to_count ? (int32_T)
30     POS_ZCSIG : (int32_T)ZERO_ZCSIG);
31
32     /* End of Outputs for SubSystem: '<Root>/Amplifier' */
33
34     /* Switch: '<Root>/Switch' */
35     if (!rtb_equal_to_count) {
36         /* Update for UnitDelay: '<Root>/X' incorporates:
37          * Constant: '<Root>/RESET'
38          */
39         rtDWork.X = 0U;
40     }
41
42     /* End of Switch: '<Root>/Switch' */
43 }

```

10. Close the model.

```

bdclose(model)
rtdemoclean;

```

Generate Code Modules

In this section...
“Introduction” on page 16-8
“Generated Code Modules” on page 16-8
“User-Written Code Modules” on page 16-11
“Customize Generated Code Modules” on page 16-11

Introduction

This section summarizes the code modules and header files that make up a Embedded Coder program and describes where to find the code modules and header files.

The easiest way to locate and examine the generated code files is to use the HTML code generation report. The code generation report provides a table of hyperlinks that you click to view the generated code in the MATLAB Help browser. For more information, see “Traceability in Code Generation Report” on page 18-4.

Generated Code Modules

The Embedded Coder software creates a build folder in your working folder to store generated source code. The build folder also contains object files, a makefile, and other files created during the code generation process. The default name of the build folder is *model_ert_rtw*.

Embedded Coder® File Packaging on page 16-9 summarizes the structure of source code generated by the Embedded Coder software.

Embedded Coder File Packaging

File	Description
<i>model.c</i> or <i>.cpp</i>	Contains entry points for code implementing the model algorithm (for example, <i>model_step</i> , <i>model_initialize</i> , and <i>model_terminate</i>).
<i>model_private.h</i>	Contains local macros and local data that are required by the model and subsystems. This file is included in the <i>model.c</i> file as a <code>#include</code> statement. You do not need to include <i>model_private.h</i> when interfacing handwritten code to the generated code of a model.
<i>model.h</i>	Declares model data structures and a public interface to the model entry points and data structures. Also provides an interface to the real-time model data structure (<i>model_M</i>) with accessor macros. <i>model.h</i> is included in the subsystem <i>.c</i> or <i>.cpp</i> files of the model. If you are interfacing your handwritten code to generated code for one or more models, include <i>model.h</i> for each of those models.
<i>model_data.c</i> or <i>.cpp</i> (conditional)	<i>model_data.c</i> or <i>.cpp</i> is conditionally generated. It contains the declarations for the parameters data structure, the constant block I/O data structure, and any zero representations for the model structure data types. If these data structures and zero representations are not used in the model, <i>model_data.c</i> or <i>.cpp</i> is not generated. These structures and zero representations are declared <code>extern</code> in <i>model.h</i> .
<i>model_types.h</i>	Provides forward declarations for the real-time model data structure and the parameters data structure. Function declarations of reusable functions might need these declarations. Also provides type definitions for user-defined types used by the model.
<i>rtwtypes.h</i>	Defines data types, structures, and macros required by Embedded Coder generated code. Most other generated code modules also require these definitions.
<i>ert_main.c</i> or <i>.cpp</i> (optional)	If the Generate an example main program option is on, this file is generated. (This option is on by default.) See “Generate an example main program”.

Embedded Coder File Packaging (Continued)

File	Description
rtmodel.h (optional)	<p>If the Generate an example main program option is off, this file is generated. (See “Generate an example main program”.)</p> <p>rtmodel.h contains <code>#include</code> directives required by the static <code>rt_main.c</code> main program module. Because <code>rt_main.c</code> is not created at code generation time, it includes <code>rtmodel.h</code> to access model-specific data structures and entry points.</p> <p>For more information, see “Static Main Program Module” on page 20-12.</p>
model_capi.c or .cpp model_capi.h (optional)	<p>Provides data structures that enable a running program to access model signals, states, and parameters without external mode. To learn how to generate and use the <code>model_capi.c</code> or <code>.cpp</code> and <code>.h</code> files, see “Data Interchange Using the C API” in the Simulink Coder documentation.</p>

You can customize the generated set of files in several ways:

- **File packaging formats:** Specify the number of source files generated for your model. In the Configuration Parameter dialog box, on the **Code Generation > Code Placement** pane, specify the **File packaging format** parameter. For more information, see “Customize Generated Code Modules” on page 16-11.
- **Nonvirtual subsystem code generation:** Instruct the code generation software to generate separate functions, within separate code files, for nonvirtual subsystems. You can control the names of the functions and of the code files. For further information, see “Code Generation of Subsystems”.
- **Custom storage classes:** Use custom storage classes to partition generated data structures into different files based on file names that you specify. For further information, see “Introduction to Custom Storage Classes” on page 10-2.

- **Module Packaging Features (MPF):** Direct the generated code into a required set of .c or .cpp and .h files, and control the internal organization of the generated files. For details, see “Data, Function, and File Definition”.

User-Written Code Modules

Code that you write to interface with generated model code usually includes a customized main module (based on a main program provided by the code generation software), and may also include interrupt handlers, device driver blocks and other S-functions, and other supervisory or supporting code.

Establish a working folder for your own code modules. Put your working folder on the MATLAB path. Minimally, you must also modify the ERT template makefile and system target file so that the build process can find your source and object files. If you want to generate code for a particular microprocessor or development board and deploy the code on target hardware with a cross-development system, make more extensive modifications to the ERT target files.

For information on how to customize the ERT target for your production requirements, see “Target Development”.

Customize Generated Code Modules

Embedded Coder software provides a configuration parameter to specify how the generated source code is packaged into files. The configuration parameter “File packaging format” drop-down list options are located in the Configuration Parameter dialog box, on the **Code Generation > Code Placement** pane, in the Code Packaging section. The options are: **Modular**, **Compact (with separate data file)**, and **Compact. Generated Files**. According to File Packaging Format on page 16-12 shows the files generated for each file packaging format and the files that have been removed.

Generated Files According to File Packaging Format

File Packaging Format	Generated Files	Removed Files
Modular (default)	<i>model.c</i> subsystem files (optional) <i>model.h</i> <i>model_types.h</i> <i>model_private.h</i> <i>model_data.c</i> (conditional)	None
Compact (with separate data file)	<i>model.c</i> <i>model.h</i> <i>model_data.c</i> (conditional)	<i>model_private.h</i> <i>model_types.h</i> (conditional, see below)
Compact	<i>model.c</i> <i>model.h</i>	<i>model_data.c</i> <i>model_private.h</i> <i>model_types.h</i> (conditional, see below)

The code generation process places the content of the removed files as follows:

Removed File	Generated Content In File
<i>model_private.h</i>	<i>model.c</i> and <i>model.h</i>
<i>model_types.h</i>	<i>model.h</i>
<i>model_data.c</i>	<i>model.c</i>

You can specify a different file packaging format for each referenced model.

If you specify **Shared code placement** as Shared location on the **Code Generation > Interface** pane of the Configuration Parameter dialog box, the

code generation process generates separate files for utility code in a shared location, regardless of the file packaging format. If you specify the **Shared code placement** as Auto, the generated code for utilities is dependent on the file packaging format as follows:

- Modular: Some shared utility files are in the build directory
- Compact (with separate data file): Utility code is generated in *model.c*
- Compact: Utility code is generated in *model.c*

File packaging formats Compact and Compact (with separate data file) generate *model_types.h* for models containing:

- A Model Variants block or a Variant Subsystem block. The *model_types.h* file includes preprocessor directives defining the variant objects associated with a variant block.
- Custom storage classes specifying a separate header file. The *model_types.h* file includes the `#include` call to the external header file.

File packaging formats Compact and Compact (with separate data file) are not compatible with the following:

- A model containing a subsystem, which is configured to generate separate source files
- A model containing a noninlined S-function
- A model for which **Shared code placement** is set to Auto, which uses data objects for which **Data scope** is set to Exported

Generate Reentrant Code from MATLAB Code

In this section...

“What Is Reentrant Code?” on page 16-14

“When to Generate Reentrant Code” on page 16-14

“Generate Reentrant Code” on page 16-15

“Generated Code API” on page 16-16

“Call Reentrant Code in a Single-Thread Environment” on page 16-16

“Call Reentrant Code in a Multithreaded Environment” on page 16-17

“Call Reentrant Code with No Persistent or Global Data (UNIX Only)” on page 16-18

“Call Reentrant Code — Multithreaded with Persistent Data (Windows Only)” on page 16-24

“Call Reentrant Code — Multithreaded with Persistent Data (UNIX Only)” on page 16-30

What Is Reentrant Code?

Reentrant code is a reusable programming routine that multiple programs can use simultaneously. Operating systems and other system software that uses multithreading to handle concurrent events use reentrant code. Sharing code with persistent or static data in a concurrent environment is difficult because multiple threads or processes might attempt to simultaneously read and write the static data. Reentrant code does not contain static data. Calling programs maintain their state variables and pass them into the function. Therefore, any number of threads or processes can share one copy of a reentrant routine.

With an Embedded Coder license, you can use `codegen` to generate reusable code. For more information, see “Generate Reentrant Code” on page 16-15.

When to Generate Reentrant Code

Generate reentrant code when you want to:

- Deploy your code in multi-threaded environments.

- Share the same algorithm with different persistent data.
- Compile code that uses function variables that are too large to fit on the stack.

If you do not choose to generate reentrant code, `codegen` generates code that uses statically allocated memory for function variables that are too large to fit on the stack, and for global and persistent variables. The use of static memory allocation for these variables means that you cannot deploy the generated code in environments that require code to be reentrant. In addition, the generated code can result in static memory size overflow if you cannot adjust the static memory allocation size to accommodate the static memory requirements of the program.

When you generate reentrant code, `codegen` creates input data structures for function variables that are too large to fit on the stack, and for persistent and global variables. You can then dynamically allocate memory for these input structures. The use of dynamic memory allocation means that you can deploy the code in reentrant environments.

Generate Reentrant Code

Prerequisites

This option requires an Embedded Coder license.

Procedure

Use the `MultiInstanceCode` option of the `coder.EmbeddedCodeConfig` code generation configuration object. For example, to compile the file `foo.m` and generate reusable code:

- 1 Create a code generation configuration object and enable the `MultiInstanceCode` option.

```
cfg = coder.config('lib', 'ecoder', true);  
cfg.MultiInstanceCode = true;
```

- 2 Pass the configuration object to `codegen` using the `-config` option.

```
codegen -config cfg foo
```

Alternatively, you can set this parameter using the MATLAB Coder Project Settings dialog box. On the **Interface** pane, select **Generate reusable code**.

Generated Code API

When you generate reusable code, `codegen` supports dynamic allocation of function variables that are too large for the stack, as well as persistent and global variables. It generates a header file, `primary_function_name_types.h`, which you must include when using the generated code. This header file contains the following structures:

- `primary_function_nameStackData`

This structure contains the user allocated memory. You must pass a pointer to this structure as the first parameter to all functions that use it either directly, because the function uses a field in the structure, or indirectly, because the function passes the structure to a called function.

The `primary_function_nameStackData` structure also contains a pointer to the `primary_function_namePersistentData` structure if the algorithm uses persistent or global data. Including this pointer means that you have to pass only one parameter to each calling function.

- `primary_function_namePersistentData`

If your algorithm uses persistent or global variables, `codegen` provides a separate structure for them and adds a pointer to this structure to the memory allocation structure. Having a separate structure for persistent and global variables allows you to allocate memory for these variables once and share them with all threads. However, if there is no communication between threads, you can choose to allocate memory for these variables per thread or per application.

For more information on using these global structures, see “Multithreaded Examples” on page 16-18.

Call Reentrant Code in a Single-Thread Environment

To call reentrant code in a single-thread environment, create a `main` function that:

- Includes the header file *primary_function_name.h*.
- Allocates memory for the global memory allocation structure *primary_function_nameStackData*.
- If the algorithm uses persistent or global data, allocates memory for the global structure *primary_function_namePersistentData*, .
- Calls these functions:
 - *primary_function_name_initialize*.
 - *primary_function_name*.
 - *primary_function_name_terminate*.

When you convert a MATLAB function to a C/C++ library function or a C/C++ executable, codegen automatically generates two housekeeping functions that you must call with the C/C++ function. For more information, see “Calling Initialize and Terminate Functions”.

- Frees the memory used for global structures.

Call Reentrant Code in a Multithreaded Environment

To call reentrant code, create a main function that:

- Includes the header file *primary_function_name.h*.
- For each thread, allocates memory for the global memory allocation structure *primary_function_nameStackData*.
- If the algorithm uses persistent or global data, allocates memory for the global structure *primary_function_namePersistentData*. If there is communication between threads, you must allocate this memory once for the application. Otherwise, you can choose to allocate memory per thread or per application.
- Contains a thread function that calls these functions:
 - *primary_function_name_initialize*.
 - *primary_function_name*.
 - *primary_function_name_terminate*.

When you convert a MATLAB function to a C/C++ library function or a C/C++ executable, codegen automatically generates two housekeeping

functions that you must call with the C/C++ function. For more information, see “Calling Initialize and Terminate Functions” in the MATLAB Coder documentation.

- Initializes each thread and passes in a pointer to the memory allocation structure as the first parameter to the thread function.
- Frees the memory used for global structures.

Multithreaded Examples

Type of Reentrant Code	Platform	Reference
Multithreaded without persistent or global data	Windows	“Generating Reentrant C Code from MATLAB Code”
	UNIX	“Call Reentrant Code with No Persistent or Global Data (UNIX Only)” on page 16-18
Multithreaded with persistent or global data	Windows	“Call Reentrant Code — Multithreaded with Persistent Data (Windows Only)” on page 16-24
	UNIX	“Call Reentrant Code — Multithreaded with Persistent Data (UNIX Only)” on page 16-30

Call Reentrant Code with No Persistent or Global Data (UNIX Only)

This example requires POSIX thread (pthread) libraries and, therefore, runs only on UNIX platforms. It is a simple multithreaded example that uses no persistent or global data. Two threads call the MATLAB function `matrix_exp` with different sets of input data.

MATLAB Code Used for This Example

```
function Y = matrix_exp(X) %#codegen
%
% The function matrix_exp computes matrix exponential
% of the input matrix using Taylor series and returns
% the computed output.
%
```



```

E = zeros(size(X));
F = eye(size(X));
k = 1;
while norm(E+F-E,1) > 0
    E = E + F;
    F = X*F/k;
    k = k+1;
end
Y = E;

```

Provide a Main Function

To call the reentrant code, you must provide a main function that:

- Includes the header file `matrix_exp.h`.
- For each thread, allocates memory for stack data.
- Calls the `matrix_exp_initialize` housekeeping function. For more information, see “Calling Initialize and Terminate Functions”.
- Calls `matrix_exp`.
- Calls `matrix_exp_terminate`.
- Frees the memory used for stack data.

For this example, `main.c` contains:

```

#include <stdio.h>
#include <stdlib.h>
#include <pthread.h>
#include "matrix_exp.h"
#include "matrix_exp_initialize.h"
#include "matrix_exp_terminate.h"
#include "rtwtypes.h"
#define NUMELEMENTS (160*160)

typedef struct {
    real_T in[NUMELEMENTS];
    real_T out[NUMELEMENTS];
    matrix_expStackData* spillData;

```

```
} IODATA;

/* The thread_function calls the matrix_exp function written in MATLAB */
void *thread_function(void *dummyPtr) {
    IODATA *myIOData = (IODATA*)dummyPtr;
    matrix_exp_initialize();
    matrix_exp(myIOData->spillData, myIOData->in, myIOData->out);
    matrix_exp_terminate();
}

int main() {
    pthread_t thread1, thread2;
    int  iret1, iret2;
    IODATA data1;
    IODATA data2;
    int32_T i;

    /*Initializing data for passing to the 2 threads*/
    matrix_expStackData* sd1=(matrix_expStackData*)calloc(1,sizeof(matrix_expStackData));
    matrix_expStackData* sd2=(matrix_expStackData*)calloc(1,sizeof(matrix_expStackData));

    data1.spillData = sd1;
    data2.spillData = sd2;

    for (i=0;i<NUMELEMENTS;i++) {
        data1.in[i] = 1;
        data1.out[i] = 0;
        data2.in[i] = 1.1;
        data2.out[i] = 0;
    }

    /*Initializing the 2 threads and passing required data to the thread functions*/
    printf("Starting thread 1...\n");
    iret1 = pthread_create(&thread1, NULL, thread_function, (void*) &data1);
    if (iret1 != 0){
        perror( "Thread 1 creation failed.");
        exit(EXIT_FAILURE);
    }

    printf("Starting thread 2...\n");
```

```
    irect2 = pthread_create(&thread2, NULL, thread_function, (void*) &data2);
    if (irect2 != 0){
        perror( "Thread 2 creation failed.");
        exit(EXIT_FAILURE);
    }

    /*Wait for both the threads to finish execution*/
    irect1 = pthread_join(thread1, NULL);
    if (irect1 != 0){
        perror( "Thread 1 join failed.");
        exit(EXIT_FAILURE);
    }

    irect2 = pthread_join(thread2, NULL);
    if (irect2 != 0){
        perror( "Thread 2 join failed.");
        exit(EXIT_FAILURE);
    }

    free(sd1);
    free(sd2);

    printf("Finished Execution!\n");
    exit(EXIT_SUCCESS);
}
```

Generate Reentrant C Code

Run the following script at the MATLAB command line to generate code.

```
% This example can only be run on Unix platforms
if ~isunix
    error('This example requires pthread libraries and can only be run on Unix.');
```

```
end

% Setting the options for the Config object

% Create a code gen configuration object
e = coder.config('exe','ecoder', true);

% Enable reentrant code generation
e.MultiInstanceCode = true;

% Set the post code generation command to be the 'setbuildargs' function
e.PostCodeGenCommand = 'setbuildargs(buildInfo)';

% Compiling
codegen -config e main.c matrix_exp.m -report -args ones(160,160)
```

These commands:

- Check that the example is running on UNIX platforms and generates an error message if not.
- Create a Simulink Coder configuration object for an ERT target.
- Enable the `MultiInstanceCode` option to generate reusable, reentrant code.
- Use the `PostCodeGenCommand` option to set the post-code-generation command to be the `setbuildargs` function. This function sets the `-lpthread` flag to specify that the build include the pthread library.

```
function setbuildargs(buildInfo)
% The example being compiled requires pthread support.
% The -lpthread flag requests that the pthread library
% be included in the build
    linkFlags = {'-lpthread'};
    addLinkFlags(buildInfo, linkFlags);
```

For more information about the `PostCodeGenCommand` option, see “Customize the Post-Code-Generation Build Process”.

- Invoke `codegen` with the following options:
 - `-config` to pass in the code generation configuration object `e`.
 - `main.c` to include this file in the compilation.
 - `-report` to create a code generation report.
 - `-args` to specify an example input with class, size, and complexity.

For more information on these options, see `codegen`.

Examine the Generated Code

`codegen` generates a header file `matrix_exp_types.h`, which defines the `matrix_expStackData` global structure. This structure contains local variables that are too large to fit on the stack.

```

/*
 * matrix_exp_types.h
 *
 * MATLAB Coder code generation for function 'matrix_exp'
 */

#ifndef __MATRIX_EXP_TYPES_H__
#define __MATRIX_EXP_TYPES_H__

/* Type Definitions */
typedef struct {
    struct {
        real_T F[25600];
        real_T Y[25600];
    } f0;
} matrix_expStackData;
#endif
/* End of MATLAB Coder code generation (matrix_exp_types.h) */

```

Run the Code

Finally, call the code using the command:

```
system('./matrix_exp')
```

The executable runs and reports completion.

Call Reentrant Code – Multithreaded with Persistent Data (Windows Only)

This example requires libraries that are specific to the Microsoft Windows operating system and, therefore, runs only on Windows platforms. It is a multithreaded example that uses persistent data. Two threads call the MATLAB function `matrix_exp` with different sets of input data.

MATLAB Code Used for This Example

```
function [Y,numTimes] = matrix_exp(X) %#codegen
%
% The function matrix_exp computes matrix exponential
% of the input matrix using Taylor series and returns
% the computed output. It also returns the number of
% times this function has been called.
%
persistent count;
if isempty(count)
    count = 0;
end
count = count+1;

E = zeros(size(X));
F = eye(size(X));
k = 1;
while norm(E+F-E,1) > 0
    E = E + F;
    F = X*F/k;
    k = k+1;
end
```

```
Y = E ;  
  
numTimes = count;
```

Provide a Main Function

To call reentrant code that uses persistent data, you must provide a main function that:

- Includes the header file `matrix_exp.h`.
- For each thread, allocates memory for stack data.
- Allocates memory for persistent data, once per application if threads share data, and once per thread otherwise.
- Calls the `matrix_exp_initialize` housekeeping function. For more information, see “Calling Initialize and Terminate Functions”.
- Calls `matrix_exp`.
- Calls `matrix_exp_terminate`.
- Frees the memory used for stack and persistent data.

For this example, `main.c` contains:

```
#include <stdio.h>  
#include <stdlib.h>  
#include <windows.h>  
#include "matrix_exp.h"  
#include "matrix_exp_initialize.h"  
#include "matrix_exp_terminate.h"  
#include "rtwtypes.h"  
#define NUMELEMENTS (160*160)  
  
typedef struct {  
    real_T in[NUMELEMENTS];  
    real_T out[NUMELEMENTS];  
    real_T numTimes;  
    matrix_expStackData* spillData;  
} IODATA;
```

```
/*The thread_function calls the matrix_exp function written in MATLAB*/
DWORD WINAPI thread_function(PVOID dummyPtr) {
    IODATA *myIOData = (IODATA*)dummyPtr;
    matrix_exp_initialize(myIOData->spillData);
    matrix_exp(myIOData->spillData, myIOData->in, myIOData->out, &myIOData->numTimes);
    printf("Number of times function matrix_exp is called is %g\n",myIOData->numTimes);
    matrix_exp_terminate();
    return 0;
}

void main() {
    HANDLE thread1, thread2;
    IODATA data1;
    IODATA data2;
    int32_T i;

    /*Initializing data for passing to the 2 threads*/
    matrix_expPersistentData* pd1 = (matrix_expPersistentData*)calloc(1,sizeof(matrix_expPersistentData));
    matrix_expPersistentData* pd2 = (matrix_expPersistentData*)calloc(1,sizeof(matrix_expPersistentData));
    matrix_expStackData* sd1 = (matrix_expStackData*)calloc(1,sizeof(matrix_expStackData));
    matrix_expStackData* sd2 = (matrix_expStackData*)calloc(1,sizeof(matrix_expStackData));

    sd1->pd = pd1;
    sd2->pd = pd2;
    data1.spillData = sd1;
    data2.spillData = sd2;

    for (i=0;i<NUMELEMENTS;i++) {
        data1.in[i] = 1;
        data1.out[i] = 0;
        data2.in[i] = 1.1;
        data2.out[i] = 0;
    }

    data1.numTimes = 0;
    data2.numTimes = 0;

    /*Initializing the 2 threads and passing required data to the thread functions*/
    printf("Starting thread 1...\n");
```



```
    thread1 = CreateThread(NULL, 0, thread_function, (PVOID) &data1, 0, NULL);
    if (thread1 == NULL){
perror( "Thread 1 creation failed.");
exit(EXIT_FAILURE);
}

    printf("Starting thread 2...\n");
    thread2 = CreateThread(NULL, 0, thread_function, (PVOID) &data2, 0, NULL);
    if (thread2 == NULL){
        perror( "Thread 2 creation failed.");
        exit(EXIT_FAILURE);
    }

    /*Wait for both the threads to finish execution*/
    if (WaitForSingleObject(thread1, INFINITE) != WAIT_OBJECT_0){
perror( "Thread 1 join failed.");
exit(EXIT_FAILURE);
}

    if (WaitForSingleObject(thread2, INFINITE) != WAIT_OBJECT_0){
perror( "Thread 2 join failed.");
exit(EXIT_FAILURE);
}

    free(sd1);
    free(sd2);
    free(pd1);
    free(pd2);

    printf("Finished Execution!\n");
    exit(EXIT_SUCCESS);
}
```

Generate Reentrant C Code

Run the following script at the MATLAB command line to generate code.

```
% This example can only be run on Windows platforms
if -ispc
    error...
    ('This example requires Windows-specific libraries and can only be run on Windows. ');
end

% Setting the options for the Config object
% Create a code gen configuration object
e = coder.config('exe', 'ecoder', true);

% Enable reentrant code generation
e.MultiInstanceCode = true;

% Compiling
codegen -config e main.c -report matrix_exp.m -args ones(160,160)
```

These commands:

- Check that the example is running on Windows platforms and generates an error message if not.
- Create a code generation configuration object for an ERT target.
- Enable the `MultiInstanceCode` option to generate reusable, reentrant code.
- Invoke `codegen` with the following options:
 - `-config` to pass in the code generation configuration object `e`.
 - `main.c` to include this file in the compilation.
 - `-report` to create a code generation report.
 - `-args` to specify an example input with class, size, and complexity.

For more information on these options, see `codegen`.

Examine the Generated Code

`codegen` generates a header file `matrix_exp_types.h`, which defines:

- The `matrix_expStackData` global structure that contains local variables that are too large to fit on the stack and a pointer to the `matrix_expPersistentData` global structure.
- The `matrix_expPersistentData` global structure that contains persistent data.

```

/*
 * matrix_exp_types.h
 *
 * MATLAB Coder code generation for function 'matrix_exp'
 *
 */

#ifndef __MATRIX_EXP_TYPES_H__
#define __MATRIX_EXP_TYPES_H__

/* Type Definitions */
typedef struct {
    real_T count;
} matrix_expPersistentData;
typedef struct {
    struct {
        real_T F[25600];
        real_T Y[25600];
    } f0;
    matrix_expPersistentData *pd;
} matrix_expStackData;
#endif
/* End of code generation (matrix_exp_types.h) */

```

Run the Code

Finally, call the code using the command:

```
system('matrix_exp.exe')
```

The executable runs and reports completion.

Call Reentrant Code – Multithreaded with Persistent Data (UNIX Only)

This example requires POSIX thread (pthread) libraries and, therefore, runs only on UNIX platforms. It is a multithreaded example that uses persistent data. Two threads call the MATLAB function `matrix_exp` with different sets of input data.

MATLAB Code Used for This Example

```
function [Y,numTimes] = matrix_exp(X) %#codegen
%
% The function matrix_exp computes matrix exponential
% of the input matrix using Taylor series and returns
% the computed output. It also returns the number of
% times this function has been called.
%

persistent count;
if isempty(count)
    count = 0;
end
count = count+1;

E = zeros(size(X));
F = eye(size(X));
k = 1;
while norm(E+F-E,1) > 0
    E = E + F;
    F = X*F/k;
    k = k+1;
end
Y = E ;

numTimes = count;
```

Provide a Main Function

To call reentrant code that uses persistent data, you must provide a main function that:

- Includes the header file `matrix_exp.h`.
- For each thread, allocates memory for stack data.
- Allocates memory for persistent data, once per application if threads share data, and once per thread otherwise.
- Calls the `matrix_exp_initialize` housekeeping function. For more information, see “Calling Initialize and Terminate Functions”.
- Calls `matrix_exp`.
- Calls `matrix_exp_terminate`.
- Frees the memory used for stack and persistent data.

For this example, `main.c` contains:

```
#include <stdio.h>
#include <stdlib.h>
#include <pthread.h>
#include "matrix_exp.h"
#include "matrix_exp_initialize.h"
#include "matrix_exp_terminate.h"
#include "rtwtypes.h"
#define NUMELEMENTS (160*160)

typedef struct {
    real_T in[NUMELEMENTS];
    real_T out[NUMELEMENTS];
    real_T numTimes;
    matrix_expStackData* spillData;
} IODATA;

/*The thread_function calls the matrix_exp function written in MATLAB*/
void *thread_function(void *dummyPtr) {
    IODATA *myIOData = (IODATA*)dummyPtr;
    matrix_exp_initialize(myIOData->spillData);
```

```
matrix_exp(myIOData->spillData, myIOData->in, myIOData->out, &myIOData->numTimes);
printf("Number of times function matrix_exp is called is %g\n",myIOData->numTimes);
matrix_exp_terminate();
}

int main() {
pthread_t thread1, thread2;
int  iret1, iret2;
IODATA data1;
IODATA data2;
int32_T i;

/*Initializing data for passing to the 2 threads*/
matrix_expPersistentData* pd1 =
    (matrix_expPersistentData*)calloc(1,sizeof(matrix_expPersistentData));
matrix_expPersistentData* pd2 =
    (matrix_expPersistentData*)calloc(1,sizeof(matrix_expPersistentData));
matrix_expStackData* sd1 = (matrix_expStackData*)calloc(1,sizeof(matrix_expStackData));
matrix_expStackData* sd2 = (matrix_expStackData*)calloc(1,sizeof(matrix_expStackData));

sd1->pd = pd1;
sd2->pd = pd2;
data1.spillData = sd1;
data2.spillData = sd2;

for (i=0;i<NUMELEMENTS;i++) {
    data1.in[i] = 1;
    data1.out[i] = 0;
    data2.in[i] = 1.1;
    data2.out[i] = 0;
}

data1.numTimes = 0;
data2.numTimes = 0;

/*Initializing the 2 threads and passing required data to the thread functions*/
printf("Starting thread 1...\n");
iret1 = pthread_create(&thread1, NULL, thread_function, (void*) &data1);
if (iret1 != 0){
    perror("Thread 1 creation failed.");
```

```
exit(EXIT_FAILURE);
}

printf("Starting thread 2...\n");
iret2 = pthread_create(&thread2, NULL, thread_function, (void*) &data2);
if (iret2 != 0){
    perror( "Thread 2 creation failed.");
    exit(EXIT_FAILURE);
}

/*Wait for both the threads to finish execution*/
iret1 = pthread_join(thread1, NULL);
if (iret1 != 0){
    perror( "Thread 1 join failed.");
}
exit(EXIT_FAILURE);
}

iret2 = pthread_join(thread2, NULL);
if (iret2 != 0){
    perror( "Thread 2 join failed.");
}
exit(EXIT_FAILURE);
}

free(sd1);
free(sd2);
free(pd1);
free(pd2);

printf("Finished Execution!\n");
return(0);
}
```

Generate Reentrant C Code

Run the following script at the MATLAB command line to generate code.

```
% This example can only be run on Unix platforms
if -isunix
    error('This example requires pthread libraries and can only be run on Unix.');
```

```
end

% Setting the options for the Config object

% Specify an ERT target
e = coder.config('exe','ecoder', true);

% Enable reentrant code generation
e.MultiInstanceCode = true;

% Set the post code generation command to be the 'setbuildargs' function
e.PostCodeGenCommand = 'setbuildargs(buildInfo)';

% Compiling
codegen -config e main.c -report matrix_exp.m -args ones(160,160)
```

These commands:

- Check that the example is running on UNIX platforms and generates an error message if not.
- Create a code generation configuration object.
- Enable the `MultiInstanceCode` option to generate reusable, reentrant code.
- Use the `PostCodeGenCommand` option to set the post-code-generation command to be the `setbuildargs` function. This function sets the `-lpthread` flag to specify that the build include the pthread library.

```
function setbuildargs(buildInfo)
% The example being compiled requires pthread support.
% The -lpthread flag requests that the pthread library
% be included in the build
    linkFlags = {'-lpthread'};
    addLinkFlags(buildInfo, linkFlags);
```

For more information about the `PostCodeGenCommand` option, see “Customize the Post-Code-Generation Build Process”.

- Invokes `codegen` with the following options:
 - `-config` to pass in the code generation configuration object `e`.
 - `main.c` to include this file in the compilation.
 - `-report` to create a code generation report.
 - `-args` to specify an example input with class, size, and complexity.

For more information on these options, see `codegen`.

Examine the Generated Code

`codegen` generates a header file `matrix_exp_types.h`, which defines:

- The `matrix_expStackData` global structure that contains local variables that are too large to fit on the stack and a pointer to the `matrix_expPersistentData` global structure.
- The `matrix_expPersistentData` global structure that contains persistent data.

```

/*
 * matrix_exp_types.h
 *
 * MATLAB Coder code generation for function 'matrix_exp'
 *
 */

#ifndef __MATRIX_EXP_TYPES_H__
#define __MATRIX_EXP_TYPES_H__

/* Type Definitions */
typedef struct {
    real_T count;
} matrix_expPersistentData;
typedef struct {
    struct {
        real_T F[25600];
    }

```

```
    real_T Y[25600];  
} f0;  
matrix_expPersistentData *pd;  
} matrix_expStackData;  
#endif  
/* End of code generation (matrix_exp_types.h) */
```

Run the Code

Finally, call the code using the command:

```
system('./matrix_exp')
```

The executable runs and reports completion.

Code Generation for AUTOSAR Software Components

- “Overview of AUTOSAR Support” on page 17-2
- “Simulink Modeling Patterns for AUTOSAR” on page 17-3
- “Workflows for AUTOSAR” on page 17-31
- “Import an AUTOSAR Software Component” on page 17-34
- “Create an AUTOSAR Software Component in Simulink” on page 17-38
- “Prepare a Model for AUTOSAR Code Generation” on page 17-43
- “Generate AUTOSAR Code and Description Files” on page 17-82
- “Configure AUTOSAR Options Programmatically” on page 17-88
- “Verify AUTOSAR Code with SIL and PIL” on page 17-89
- “Limitations and Tips” on page 17-92
- “Sample Workflows and Further Reading” on page 17-100

Overview of AUTOSAR Support

Embedded Coder software supports *AUTomotive Open System ARchitecture* (AUTOSAR), an open and standardized automotive software architecture. Automobile manufacturers, suppliers, and tool developers jointly develop AUTOSAR.

The AUTOSAR standard addresses:

- Architecture – Three layers, *Application*, *Runtime Environment* (RTE), and *Basic Software*, enable decoupling of AUTOSAR Software Components from the execution platform. Standard interfaces between AUTOSAR Software Components and the Runtime Environment allow reuse or relocation of components within the Electronic Control Unit (ECU) topology of a vehicle.
- Methodology – Specification of code formats and description file templates, for example.
- Application Interfaces – Specification of interfaces for typical automotive applications.

For more information, see:

- www.autosar.org for details on the AUTOSAR standard.
- “Simulink Modeling Patterns for AUTOSAR” on page 17-3 to model AUTOSAR Software Components and related concepts in Simulink.
- “Workflows for AUTOSAR” on page 17-31 to use Embedded Coder software to generate code and description files that are compliant with AUTOSAR.
- Technical Solution 1–DTZNVZ to learn about the AUTOSAR Target Production Package. It offers advanced production capabilities for Simulink and Embedded Coder.
- <http://www.mathworks.com/automotive/standards/autosar.html> to learn about using MathWorks products and third-party tools for AUTOSAR.

Simulink Modeling Patterns for AUTOSAR

In this section...

“About Simulink Modeling Patterns for AUTOSAR” on page 17-3

“AUTOSAR Software Components” on page 17-3

“AUTOSAR Communication” on page 17-9

“Calibration Parameters” on page 17-15

“Inter-Runnable Variables” on page 17-16

“Data Types” on page 17-17

“Per-Instance Memory” on page 17-27

“AUTOSAR Terminology” on page 17-28

About Simulink Modeling Patterns for AUTOSAR

This section describes how you model AUTOSAR Software Components and related concepts in Simulink.

AUTOSAR Software Components

In AUTOSAR, application software consists of separate units, *AUTOSAR Software Components*.

Note An AUTOSAR Software Component is sometimes referred to as *atomic* because it is never split across more than one Electronic Control Unit (ECU). Do not confuse *atomic* in this context with the concept of Simulink atomic subsystems.

The behavior of an AUTOSAR Software Component is implemented by a single or multiple *runnable entities* (runnables), which expose well-defined connection points, *ports*.

In Simulink, you can represent an AUTOSAR Software Component using a model or a subsystem. For example, the following figure shows modeling

patterns for AUTOSAR Software Components (ASWC) labeled ASWC1, ASWC2, ASWC3, and ASWC4.

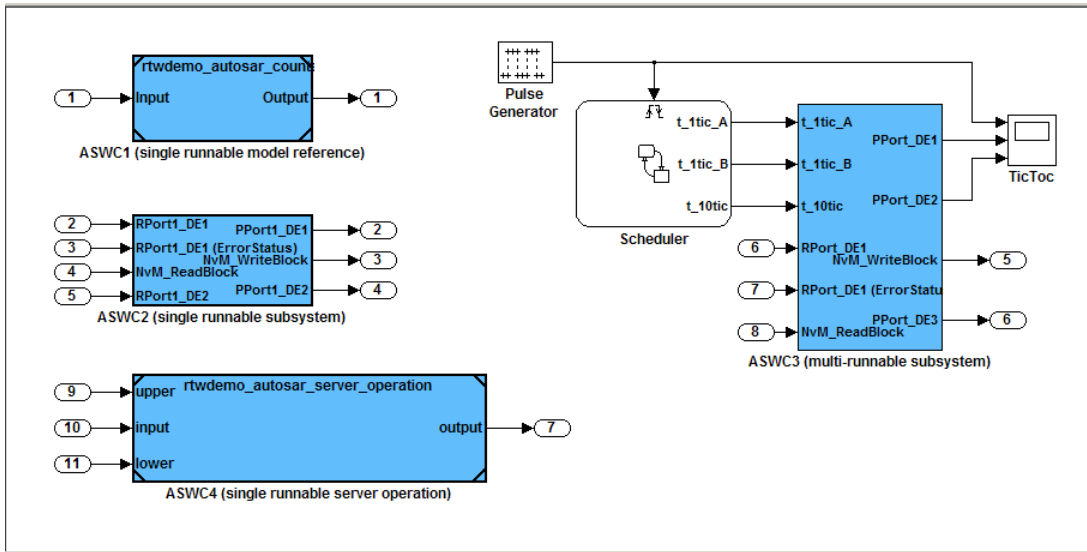

Runnables

AUTOSAR Software Components contain runnables that are directly or indirectly scheduled by the underlying AUTOSAR operating system.

The following figure shows an AUTOSAR Software Component with two runnables, Runnable 1 and Runnable 2. Each runnable is triggered by RTEEvents, events generated by the AUTOSAR Runtime Environment (RTE). For example, TimingEvent is an RTEEvent that is generated periodically.

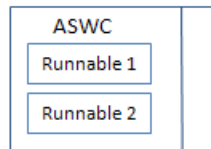

The components ASWC1, ASWC2 and ASWC4 contain single runnables. These components are represented by a subsystem or a model, and can be single- or multirate. However, the software implements each component as a single-tasking operation.

Note The software generates an additional runnable for the initialization function regardless of the modeling pattern.

ASWC2 is modeled as a single-rate, single-tasking atomic subsystem.

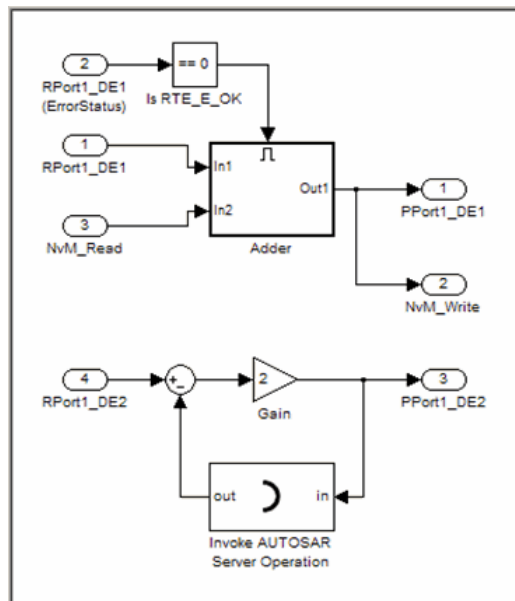

You can generate the ASWC2 runnable, which corresponds to the step function of the subsystem. Use the Configure AUTOSAR Interface dialog box to specify the names of the initial and periodic runnables, as shown by the following figure.

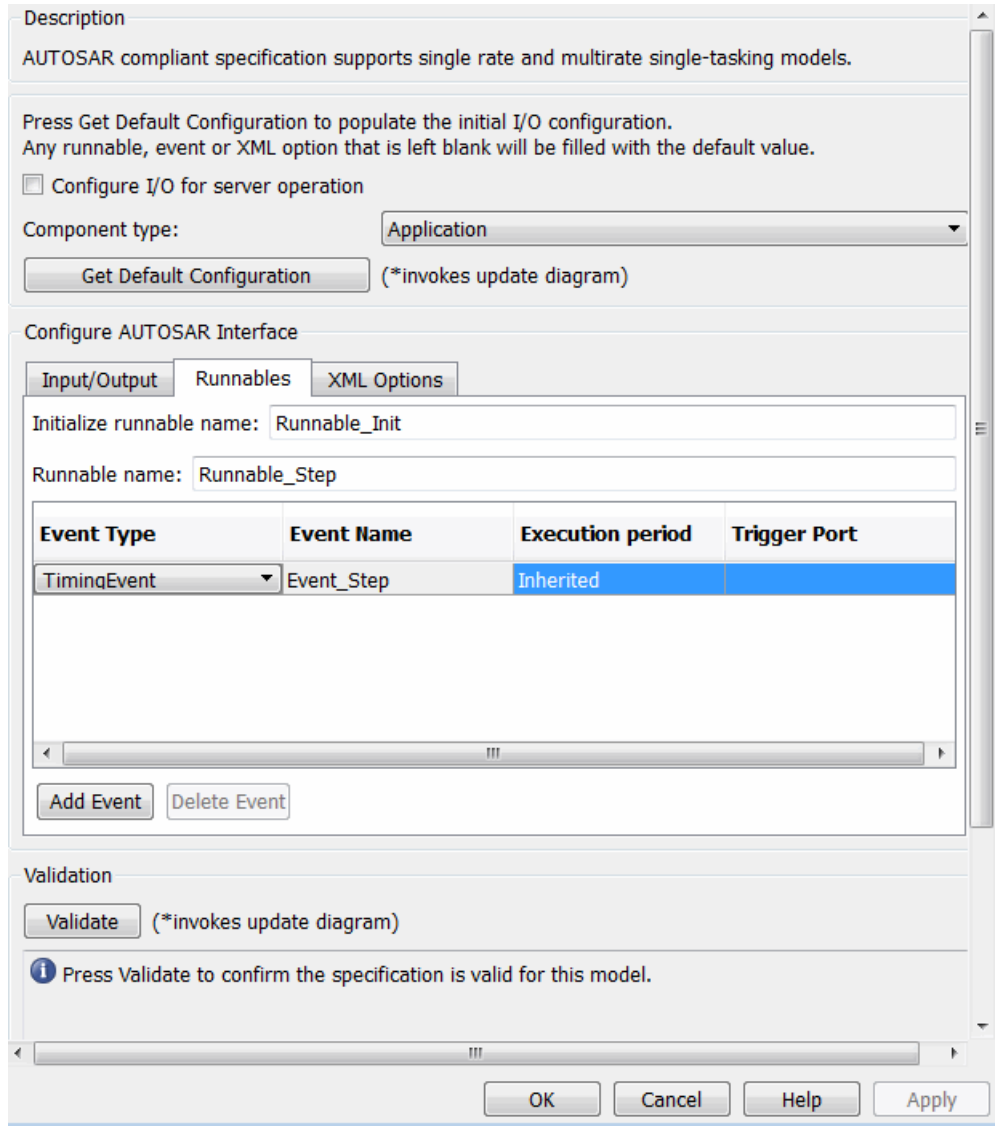

The software generates TimingEvents for the runnables. The TimingEvent period for the periodic runnable is the fundamental sample time of the model

or atomic subsystem. Specify this sample time in the Subsystem Parameters dialog box, in the **Sample time (-1 for inherited)** field.

The component ASWC3 contains multiple runnables.

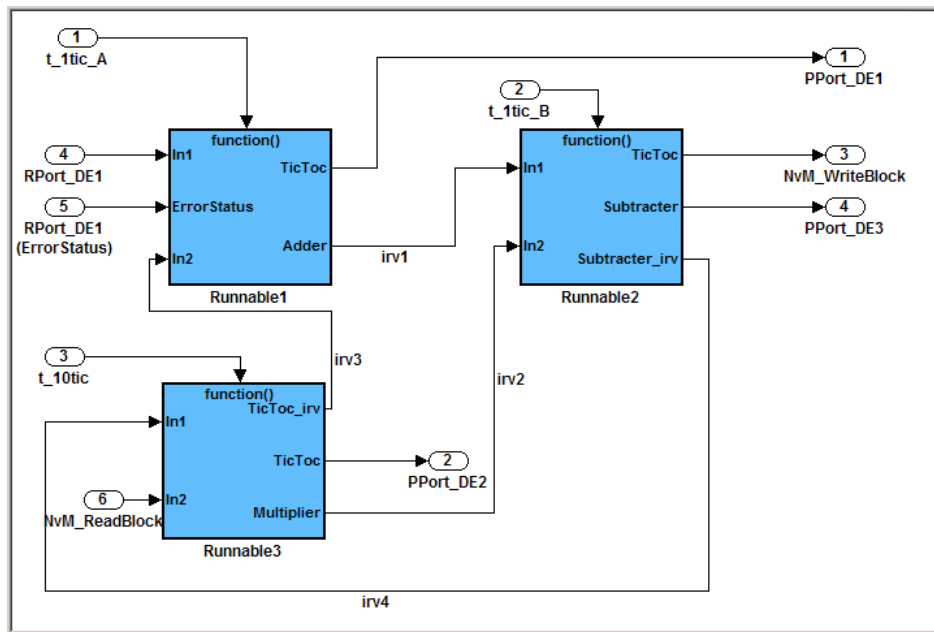

Use the Export Functions feature to map the runnables to Simulink function-call subsystems. See “Configure Multiple Runnables” on page 17-69 and “Export AUTOSAR Software Component” on page 17-85. The software also generates an initialization runnable for the initialization function.

Use the Configure AUTOSAR Interface dialog box to specify the names of the multiple runnables and the periods of TimingEvents.

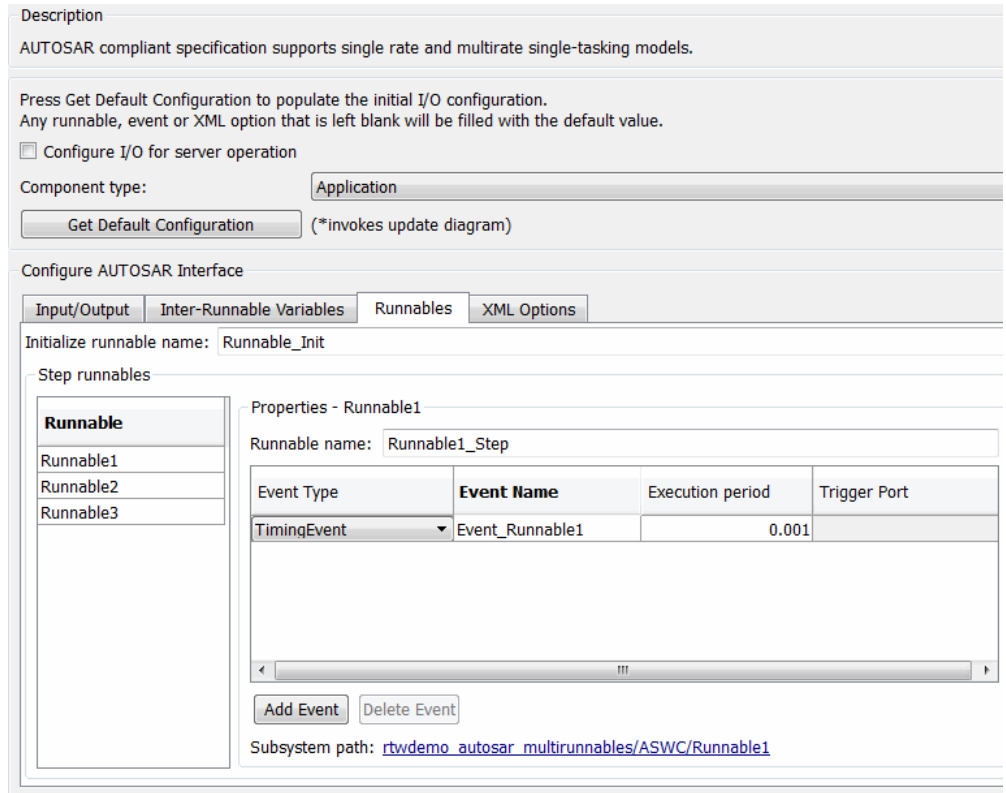

Multiple Instantiation

AUTOSAR supports multiple instantiations of software components. However, Simulink supports multiple instantiations (reentrant code) only if a model is configured as a server operation. See “Configure a Server Operation” on page 17-63.

To generate reentrant code for a model configured as a server operation, on the **Code Generation > Interface** pane of the Configuration Parameters dialog box, select **Generate reusable code**.

AUTOSAR Communication

AUTOSAR Software Components provide well-defined connection points, ports. There are two types of AUTOSAR ports:

- Require
- Provide

In addition, these AUTOSAR ports can reference two kinds of interfaces:

- Sender-Receiver
- Client-Server

The following figure shows an AUTOSAR Software Component with four ports representing the port and interface combinations.



Sender-Receiver Interface

A Sender-Receiver Interface consists of one or more data elements. Although a Require or Provide port may reference a Sender-Receiver Interface, the AUTOSAR Software Component does not necessarily access all of the data elements. For example, consider the following figure.

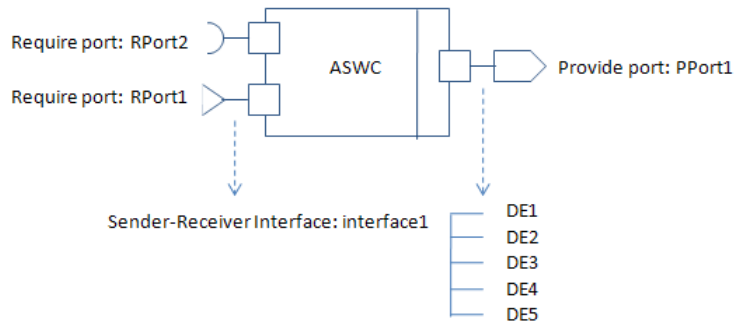

The AUTOSAR Software Component has a Require and Provide port that references the same Sender-Receiver Interface, interface1. Although this interface contains data elements DE1, DE2, DE3, DE4, and DE5, the component does not utilize all of the data elements.

The following figure is an example of how you model, in Simulink, an AUTOSAR Software Component that accesses data elements.

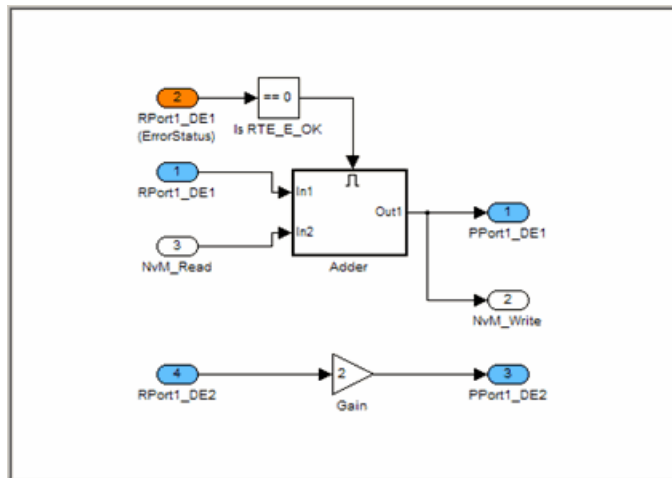

ASWC accesses data elements DE1 and DE2. You model data element access as follows:

- For Require ports, use Simulink inports. For example, RPort1_DE1 and RPort1_DE2.
- For Provide ports, use Simulink outports. For example, PPort1_DE1 and PPort1_DE2.

ErrorStatus is a value that the AUTOSAR Runtime Environment (RTE) returns to indicate errors that the communication system detects for each data element. You can use a Simulink inport to model error status, for example, RPort1_DE1 (ErrorStatus).

Use the Configure AUTOSAR Interface dialog box to specify the AUTOSAR settings for each inport and outport. The following figure shows settings for ASWC.

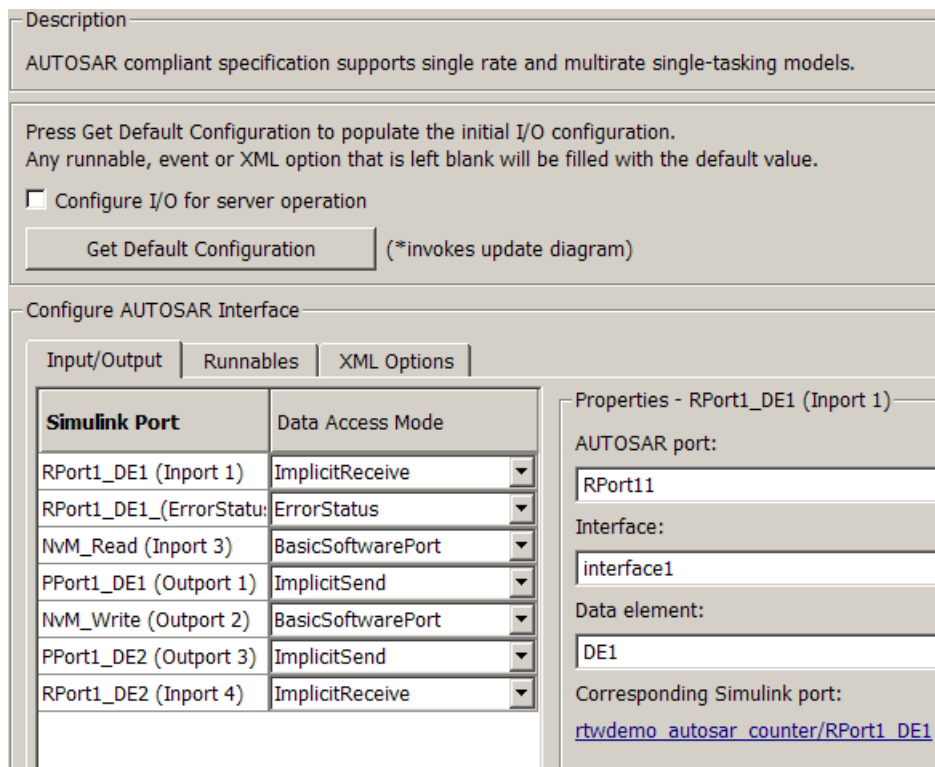

For example, the Data Access Mode for RPort1_DE1 is set to ImplicitReceive. For information on how you specify settings, see “Configure the AUTOSAR Interface” on page 17-43.

Client-Server Interface

A Client-Server Interface consists of one or more operation prototypes. An operation prototype contains one or more arguments of specific data types. A Client-Server Interface can be referenced by either a Require or Provide port.

The following figure shows an AUTOSAR Software Component with Require ports (RPort2 and NvM) that reference Client-Server Interfaces (Interface2 and NvM).

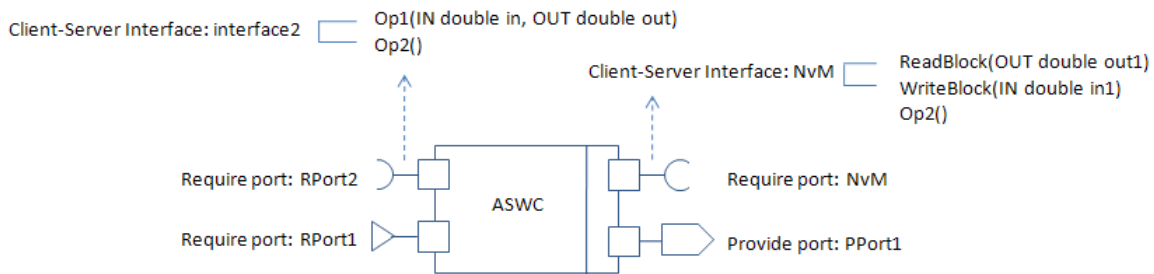

Simulink provides the following modeling patterns for Client-Server Interfaces:

- If you want to invoke a Basic Software interface with operations that have only one argument, for example, Client-Server Interface: NvM, use an inport or outport.
- If you want to invoke Basic Software or application software interfaces that contain operations potentially with multiple arguments, for example, Client-Server Interface: Interface2, use the Invoke AUTOSAR Server Operation block. See “Configure the Invoke AUTOSAR Server Operation Block” on page 17-65

The following figure shows the use of the Invoke AUTOSAR Server Operation block in modeling an AUTOSAR Software Component in Simulink.

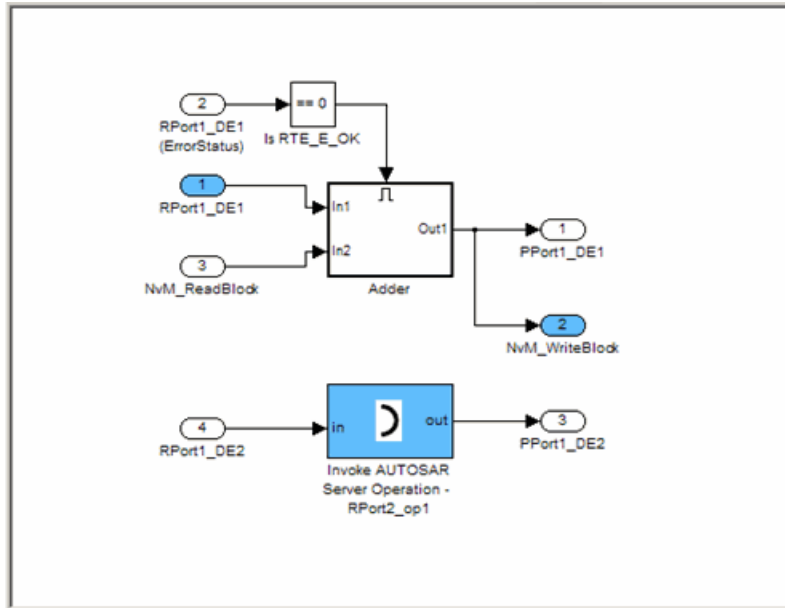

Use the Configure AUTOSAR Interface dialog box to specify the AUTOSAR settings for each inport and outport. See “Configure the AUTOSAR Interface” on page 17-43.

The following figure shows an AUTOSAR Software Component with a Provide port that references a Client-Server Interface.

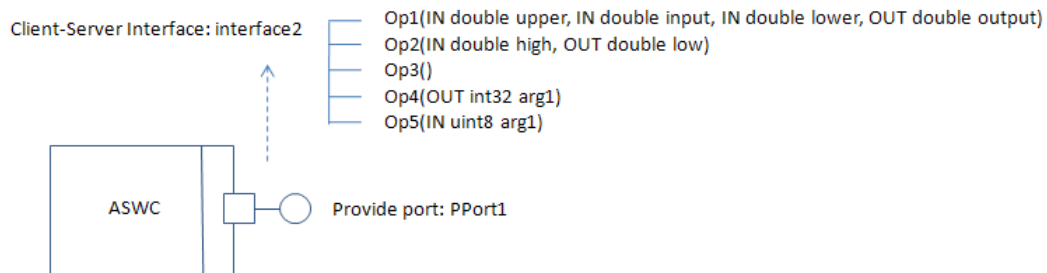

In Simulink, you can model a single operation of an AUTOSAR Software Component that is referenced by a Client-Server Interface. Consider the following model.

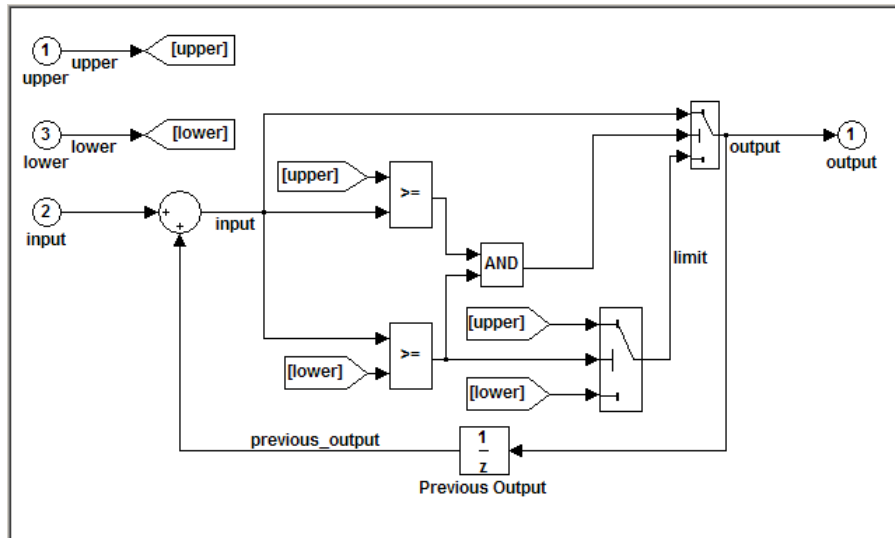

Use the Configure AUTOSAR Interface dialog box to map the inports and outports to the arguments of the operation prototype. For example, the inports map to arguments upper, input, and lower.

Description

AUTOSAR compliant specification supports single rate and multirate single-tasking models.

Press Get Default Configuration to populate the initial I/O configuration.
Any runnable, event or XML option that is left blank will be filled with the default value.

Configure I/O for server operation

Component type:

(*invokes update diagram)

Configure AUTOSAR Interface

Server Operation

Server port name:

Operation prototype:

Interface name:

Server type:

Validation

(*invokes update diagram)

 Press Validate to confirm the specification is valid for this model.

For more information, see “Configure a Server Operation” on page 17-63 .

Calibration Parameters

About Calibration Parameters

A calibration parameter is a value in an Electronic Control Unit (ECU). You tune or modify these parameters using a calibration data management tool or an offline calibration tool.

The AUTOSAR standard specifies the following types of calibration parameters:

- Calibration parameters that belong to a *calibration component*, which can be accessed by AUTOSAR Software Components.

You define calibration components using an AUTOSAR authoring tool.

- Internal calibration parameters, which are defined and accessed by only one AUTOSAR Software Component.

The software supports import, export, and code generation for both types of calibration parameters.

Import and Export Calibration Parameters

You can import calibration parameters into the MATLAB base workspace.

For example, to import parameters from an AUTOSAR calibration component description, use `arxml.importer.createCalibrationComponentObjects`.

To provide your Simulink model with access to these parameters, assign the imported parameters to block parameters.

For more information, see “Import an AUTOSAR Software Component” on page 17-34.

You can specify the type of calibration parameter exported by configuring properties of the corresponding block parameter in the base workspace. See “Configure Calibration Parameters” on page 17-77 and `rtwdemo_autosar_legacy_script`.

Inter-Runnable Variables

In AUTOSAR, *inter-runnable* variables are used to communicate primitive type data between runnables in the same component. You define these variables in a Simulink model by the signal lines that connect subsystems (runnables). For example, in the following figure, `irv1`, `irv2`, `irv3`, and `irv4` are inter-runnable variables.

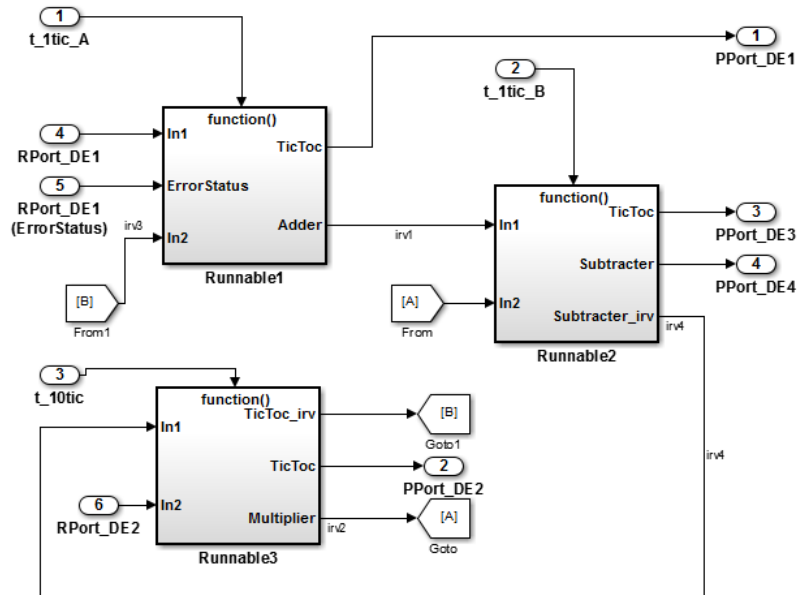

You can specify the names and data access modes of the inter-runnable variables that you export. See “Configure Inter-Runnable Variables” on page 17-70.

Data Types

AUTOSAR specifies data types that apply to:

- Data elements of a Sender-Receiver Interface
- Operation arguments of a Client-Server Interface
- Calibration parameters
- Inter-runnable variables

The data types fall into two categories:

- Primitive data types, which allow a direct mapping to C intrinsic types.
- Composite data types, which map to C arrays and structures.

You can use Simulink data types to define AUTOSAR primitive types.

AUTOSAR Data Type	Simulink Data Type
UInt4	uint8
SInt4	int8
UInt8	uint8
SInt8	int8
UInt16	uint16
SInt16	int16
UInt32	uint32
SInt32	int32
Float_with_NaN	single
Float	single
Double_with_NaN	double
Double	double
Boolean	boolean
Char8	uint8
Char16	Not supported

AUTOSAR composite data types are arrays and records, which are represented in Simulink by wide signals and bus objects, respectively. In the Inport or Outport Block Parameters dialog box, use the **Signal Attributes** pane to configure wide signals and bus objects.

The following figure shows how to specify a wide signal, which corresponds to an AUTOSAR composite array.

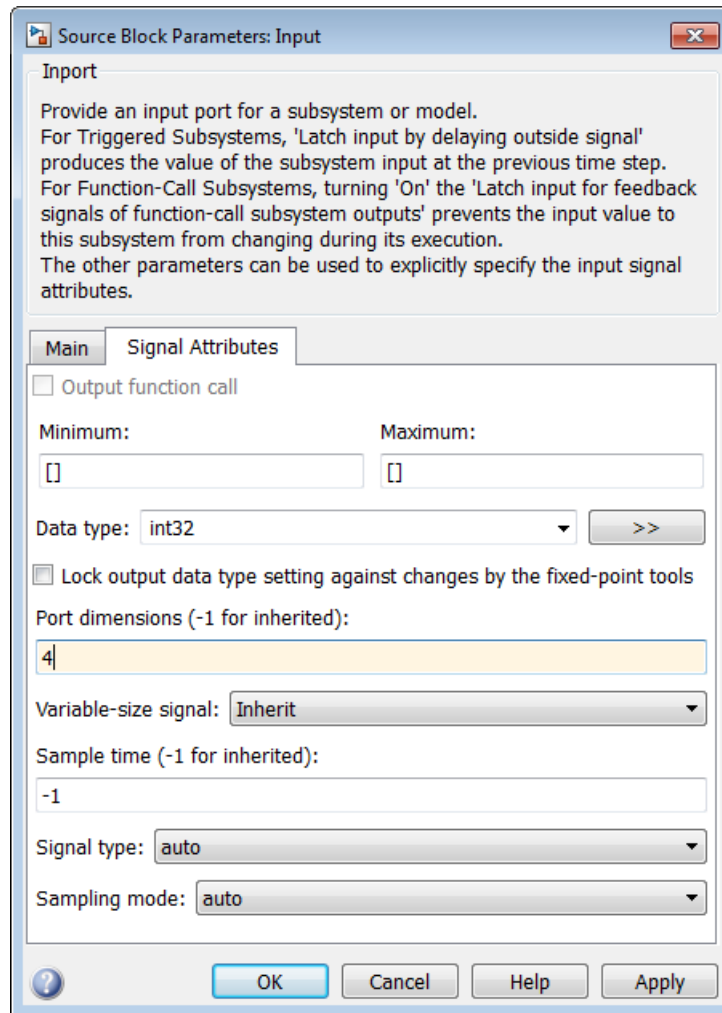

The following figure shows how to specify a bus object, which corresponds to an AUTOSAR composite record.

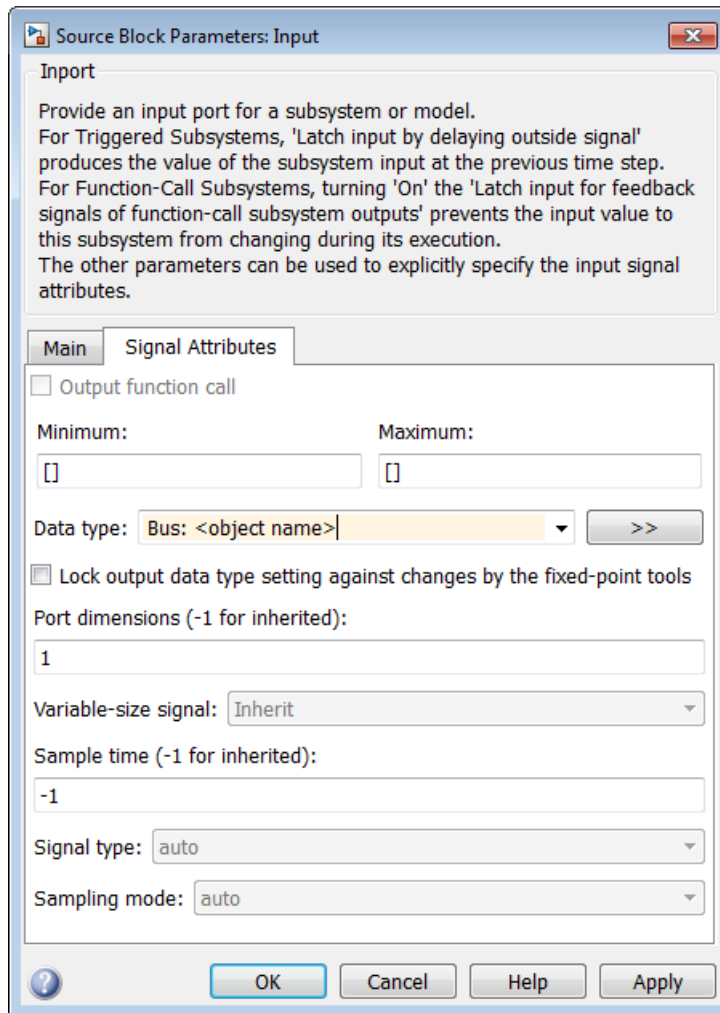

You can use the **Data Type Assistant** on the **Signal Attributes** pane of the Inport or Output Block Parameters dialog box to specify the data types of data elements and arguments of an operation prototype. If you select **Mode** to be **Built in**, then you can specify the data type to be, for example, **single** or **boolean**. Alternatively, if you select **Mode** to be **Expression**, you can specify an (alias) expression for data type. As an example, the following figure shows an alias `UInt4` in the **Data type** field.

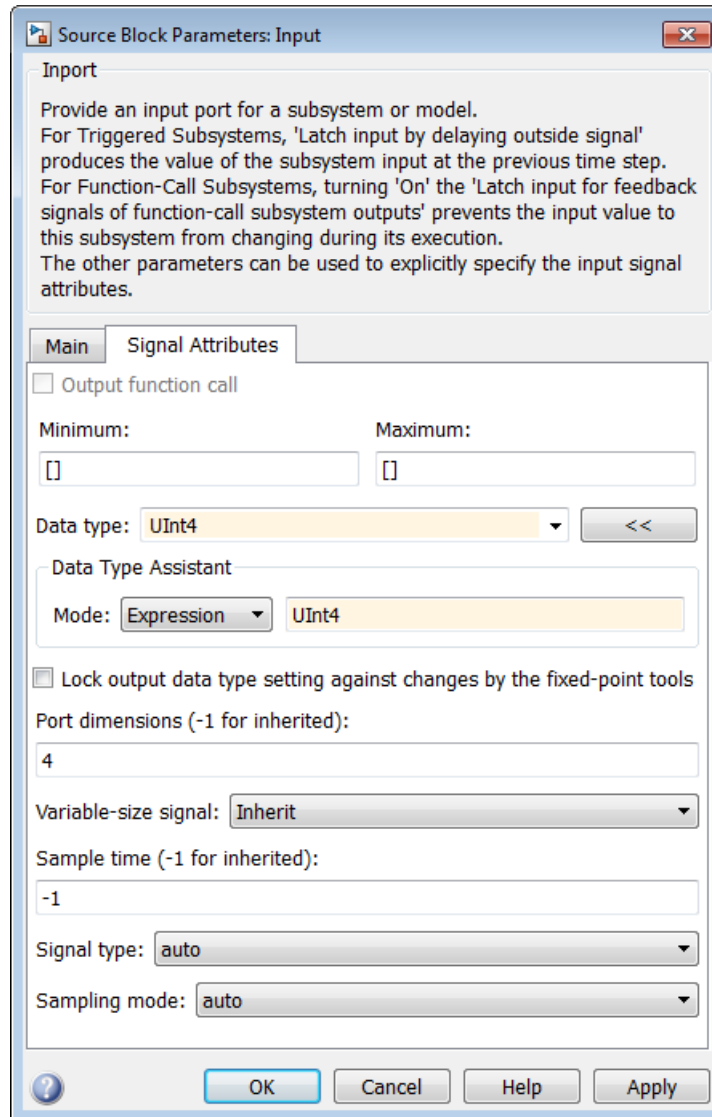

Enumerated Data Types

AUTOSAR supports enumerated data types. For the import process, if there is a corresponding Simulink enumerated data type, the software uses the data

type. The software checks that the two data types are consistent. However, if a corresponding Simulink data type is not found, the software automatically creates the enumerated data type using the `Simulink.defineIntEnumType` class. This automatic creation of data types is useful when you want to import a large number of enumerated data types.

Consider the following example:

```
<SHORT-NAME>BasicColors</SHORT-NAME>
  <COMPU-INTERNAL-TO-PHYS>
    <COMPU-SCALES>
      <COMPU-SCALE>
        <LOWER-LIMIT>0</LOWER-LIMIT>
        <UPPER-LIMIT>0</UPPER-LIMIT>
        <COMPU-CONST>
          <VT>Red</VT>
      . . . .
```

The software creates an enumerated data type using:

```
Simulink.defineIntEnumType( 'BasicColors', ...
    {'Red', 'Green', 'Blue'}, ...
    [0;1;2], ...
    'Description', 'Type definition of BasicColors.', ...
    'HeaderFile', 'Rte_Type.h', ...
    'AddClassNameToEnumNames', false);
```

Structure Parameters

Before exporting an AUTOSAR Software Component, specify the data types of structure parameters to be `Simulink.Bus` objects. See “Structure Parameters and Generated Code” in Simulink Coder documentation. Otherwise, the software displays the following behavior:

- When you validate the AUTOSAR interface, the software issues a warning.
- When you build the model, the software defines each data type to be an *anonymous* struct and generates a random, nondescriptive name for the data type.

When importing an AUTOSAR Software Component, if a parameter structure has a data type name that corresponds to an anonymous struct, the software sets the data type to struct. However, if the component has data elements that reference this anonymous struct data type, the software generates an error.

Data Type Support for Release 4.0

AUTOSAR R4.0 introduces the notion of application data types, implementation data types and base types. The duality of application and implementation data types allows the separation of the following attributes:

- Physical attributes (application level) — For example, real-world range of values, the data structure, and physical semantics.
- Implementation attributes (implementation level) — For example, stored-integer minimum and maximum values and specification of primitive type such as integer, Boolean, real, and opaque.

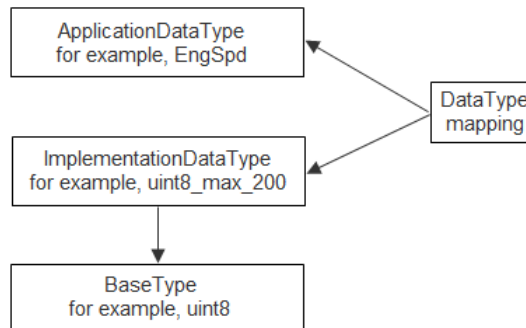

For information about how Simulink supports AUTOSAR R4.0 data types, see “R4.0 Data Types — Generate Code Without Importing XML” on page 17-24 and “R4.0 Data Types — Import XML and Generate Code” on page 17-26.

For comparison, the following table shows how the software translates AUTOSAR R2.X and R3.X data types to Simulink data types.

AUTOSAR	Simulink
Primitive types (excluding fixed point), for example, myInt16 Covers Boolean, integer, real	<pre>>> myInt16 = Simulink.AliasType; >> myInt16.BaseType = `int16`; >> myInt16.IsAlias = true; >> myInt16.HeaderFile = `Rte_Type.h`;</pre>
Primitive type (fixed point), for example, myFixPt	<pre>>> myFixPt = Simulink.NumericType; >> myFixPt.DataTypeMode = ... >> myFixPt.IsAlias = true; >> myFixPt.HeaderFile = `Rte_Type.h`;</pre>
Enumerations, for example, myEnum	<pre>Simulink.defineIntEnumType('myEnum', ... {'Red', 'Green', `Blue'},... [1;2;3], ...);</pre>
Record types, for example, myRecord	<pre>myRecord = Simulink.Bus;</pre>

R4.0 Data Types – Generate Code Without Importing XML. In this workflow, you create a Simulink model and export the model as an AUTOSAR Software Component.

The software generates the application and implementation data types and base types to preserve the information contained within the Simulink data types:

- For Simulink data types, the software generates implementation data types.

- For each fixed-point type, in addition to the implementation data type, the software generates an application data type with the COMPU-METHOD-REF element to preserve scale and bias information. This application data type is mapped to the implementation data type.

Note The software does not support application data types for code generated from referenced models.

Simulink Data Type	AUTOSAR XML	
	Implementation Type	Application Type
Primitive (excluding fixed point), for example, myInt16 <pre>>> myInt16 = Simulink.AliasType; >> myInt16.BaseType = 'int16'; >> myInt16.IsAlias = 'true'</pre> Covers Boolean, integer, real	<pre><IMPLEMENTATION-DATA-TYPE> <SHORT-NAME> myInt16</SHORT-NAME> <CATEGORY>VALUE </CATEGORY> ...</pre>	Not generated
Primitive (fixed point), for example, myFixPt <pre>>> myFixPt = Simulink.NumericType; >> myFixPt.DataTypeMode = ... >> myFixPt.IsAlias = 'true';</pre>	<pre><IMPLEMENTATION-DATA-TYPE> <SHORT-NAME> myFixPt</SHORT-NAME> <CATEGORY>VALUE </CATEGORY> ...</pre>	<pre><APPLICATION-PRIMITIVE-DATA-TYPE> <SHORT-NAME> myFixPt ... <COMPU-METHOD-REF ...</pre>

Simulink Data Type	AUTOSAR XML	
	Implementation Type	Application Type
Enumeration, for example, myEnum <pre>Simulink.defineIntEnumType('myEnum', ... { 'Red', 'Green', 'Blue' }, ... [1;2;3], ...);</pre>	<pre><IMPLEMENTATION-DATA-TYPE> <SHORT-NAME>myEnum</SHORT-NAME> <CATEGORY>VALUE <\CATEGORY> <COMPU-METHOD> ...</pre>	Not generated
Record, for example, myRecord <pre>myRecord = Simulink.Bus;</pre>	<pre><IMPLEMENTATION-DATA-TYPE> <SHORT-NAME>myRecord</SHORT-NAME> <CATEGORY>STRUCT </CATEGORY></pre>	Not generated

R4.0 Data Types – Import XML and Generate Code. With this workflow, you first import an AUTOSAR Software Component using the XML description generated by an AUTOSAR authoring tool. Later, you generate AUTOSAR code.

If the data prototype references an application data type, the software stores application to implementation data type mapping within the model and uses the application data type name to define the Simulink data type.

For example, suppose the authoring tool specifies an application data type:

```
App1DT1
```

In this case, the software defines the following Simulink data type:

```
ImplDT1
```

AUTOSAR XML		Simulink Data Type
Application Type	Implementation Type	
<pre><APPLICATION-PRIMITIVE-DATA-TYPE> <SHORT-NAME>myFixPt ... <COMPU-METHOD-REF ...</pre>	<pre><IMPLEMENTATION-DATA-TYPE> <SHORT-NAME>myInt</pre>	<pre>>> myFixPt = Simulink.NumericType; >> myFixPt.DataTypeMode = ... >> myFixPt.IsAlias = `true`;</pre>

If the data prototype references an implementation data type, the software does not store mapping information and uses the implementation data type name to define the Simulink data type.

The software uses the application data types in simulations and the implementation data types for code generation. When you re-export the AUTOSAR Software Component, the software uses the stored information to provide the same mapping between the exported application and implementation data types.

Per-Instance Memory

AUTOSAR supports per-instance memory, which allows you to specify instance-specific global memory within a software component. An AUTOSAR run-time environment generator allocates this memory and provides an API through which you access this memory.

In Simulink, you can model per-instance memory through the use of Data Store Memory and Data Store Read/Write blocks together with an `AUTOSAR.Signal` data object that specifies, for example, the `PerInstanceMemory` custom storage class.

AUTOSAR also allows you to use per-instance memory as a RAM mirror for data in non-volatile RAM (NVRAM), which enables you to access and use NVRAM in your AUTOSAR application.

Once an `AUTOSAR.Signal` data object specifies the `PerInstanceMemory` custom storage class, you can configure this per-instance memory to be a mirror block for a specific NVRAM block by setting the attribute `needsNVRAMAccess` to true.

For detailed information about how you model per-instance memory, see the example `rtwdemo_autosar_PIM_script`. For an outline, see “Use Data Store Memory Blocks to Specify Per-Instance Memory” on page 17-79.

AUTOSAR Terminology

Term	Notes
AUTOSAR Runtime Environment (RTE)	<ul style="list-style-type: none"> • Layer between Application and Basic Software layers • Realizes communication between: <ul style="list-style-type: none"> ▪ AUTOSAR Software Components ▪ AUTOSAR Software Components and Basic Software
AUTOSAR Software Component	<ul style="list-style-type: none"> • A software component containing one or more algorithms, which communicates with its environment through ports • Connected to the AUTOSAR Runtime Environment (RTE) • Relocatable (not tied to a particular ECU)
Characteristics	Values of characteristics can be changed on an ECU through a calibration data management tool or an offline calibration tool.
Client-Server Interface	<ul style="list-style-type: none"> • <code>PortInterface</code> for client-server communication • Defines operations provided by server and used by client

Term	Notes
Composite data types	Category of data types, such as one of the following: <ul style="list-style-type: none"> • Array — Contains more than one element of the same type, and has zero-based indexing • Record — Non-empty set of objects, where each object has a unique identifier
ComSpec	Defines specific communication attributes.
DataElementPrototype (data element)	Data value (signal) exchanged between a sender and a receiver.
Data types	<ul style="list-style-type: none"> • Either primitive or composite • Types data elements, arguments of operations in a Client-Server Interface, and constants
ErrorStatus	Indicates errors detected by communication system. Runtime Environment defines the following macros for sender-receiver communication: <ul style="list-style-type: none"> • RTE_E_OK: no errors • RTE_E_INVALID: data element invalid • RTE_E_MAX_AGE_EXCEEDED: data element outdated
OperationPrototype (operation)	<ul style="list-style-type: none"> • Invoked by a client • Provides value for each argument with direction <code>in</code> or <code>inout</code>, which must be of the corresponding data type • Client expects to receive a response to the invoked operation, part of which is a value with direction <code>out</code> or <code>inout</code>
PortInterface	<ul style="list-style-type: none"> • Characterizes information provided or required by a port • Can be either Sender-Receiver Interface or Client-Server Interface

Term	Notes
Primitive data types	Category of data types that allow a direct mapping to C intrinsic types.
Provide port (PPort)	Port providing data or service of a server.
Require port (RPort)	Port requiring data or service of a server.
RTEEvent	Event or situation that triggers execution of a runnable by the Runtime Environment (RTE). The software supports the following RTEEvents: <ul style="list-style-type: none"> • OperationInvokedEvent (applicable to server operations) • TimingEvent • DataReceivedEvent
Runnable entity (runnable)	Part of AUTOSAR Software-Component that can be executed and scheduled independently of other runnable entities (runnables).
Sender-Receiver Interface	<ul style="list-style-type: none"> • PortInterface for sender-receiver communication • Defines data elements sent by sending component (with <code>Provide</code> port providing Sender-Receiver Interface) or received by receiving component (with <code>Require</code> requiring Sender-Receiver Interface)
Sender Receiver Annotation	Annotation of data elements in a port that implements Sender-Receiver Interface.
Sensor Actuator Software Component	AUTOSAR Software Component dedicated to the control of a sensor or actuator.
Service	Logical entity of Basic Software that offers functionality, which is used by various AUTOSAR Software Components.

Workflows for AUTOSAR

This section describes how you use Embedded Coder software to configure a Simulink representation of an AUTOSAR application for model-based design, and subsequently generate AUTOSAR-compliant code from the model.

Two typical workflows are

- The *round-trip* workflow, in which you import AUTOSAR Software Components created by an AUTOSAR authoring tool (AAT) into the Simulink model-based design environment, and later export XML descriptions and C code for merging back into the AAT environment.
- The Simulink originated, or *bottom-up*, workflow, in which you take a model-based design that originated in Simulink, configure and evolve it for AUTOSAR code generation, and export XML descriptions and C code for use in the AUTOSAR environment.

The following diagram shows the round-trip workflow.

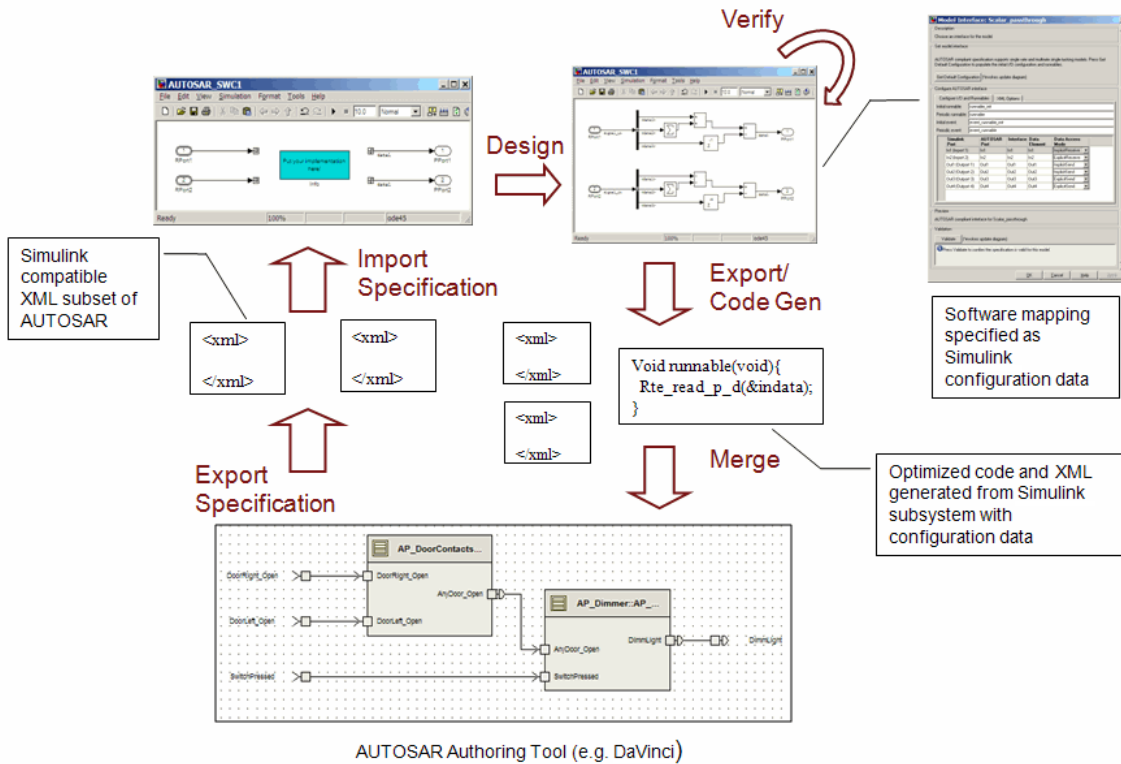

In the round-trip workflow, you perform the following tasks:

- 1 Import previously specified AUTOSAR Software Components, including definitions of calibration parameters, into Simulink. See:
 - “Import an AUTOSAR Software Component” on page 17-34
 - “Configure Calibration Parameters” on page 17-77
- 2 Develop the model using Simulink model-based design. This process includes mapping Simulink model elements to AUTOSAR component elements, configuring the AUTOSAR interface, and validating the interface. See:
 - “Configure the AUTOSAR Interface” on page 17-43

- “Configure Ports for Basic Software and Error Status Receivers” on page 17-60
 - “Configure Client-Server Communication” on page 17-61
 - “Configure AUTOSAR Options Programmatically” on page 17-88
 - “Modify and Validate an Existing AUTOSAR Interface” on page 17-80
- 3** Export the AUTOSAR component from Simulink, generating XML description files and C code files. See:
- “Export AUTOSAR Software Component” on page 17-85
 - “Configure Multiple Runnables” on page 17-69

You can also verify your generated code in a simulation. See “Verify AUTOSAR Code with SIL and PIL” on page 17-89.

- 4** Merge generated code and description files with other systems using an AUTOSAR authoring tool. See example `rtwdemo_autosar_roundtrip_script`.

You can use the authoring tool to export specifications, which can be imported back into Simulink.

In the Simulink originated (*bottom-up*) workflow, you perform the same tasks as with the round-trip workflow, except that rather than importing AUTOSAR Software Components from an AAT (step 1), you start with a Simulink model-based design and use Simulink to create a customized AUTOSAR component. See “Create an AUTOSAR Software Component in Simulink” on page 17-38. Subsequent tasks in the workflow are as listed above.

Import an AUTOSAR Software Component

The AUTOSAR software component importer tool parses an AUTOSAR Software Component description file produced, for example, by an AUTOSAR authoring tool (AAT) and imports software component information into a Simulink model for further configuration and model-based design.

The tool imports a subset of the elements and objects from an arxml file representing an AUTOSAR Software Component. The subset consists of AUTOSAR objects and properties relevant for Simulink model-based design of an automotive application, for example, AUTOSAR Components, Ports, Interfaces, DataTypes, and Packages.

As part of the import operation, the tool validates the XML in the imported arxml files. If XML validation fails for a file, the tool displays errors. For example:

```
Error
The IsService attribute is undefined for interface /mtest_pkg/mtest_if/In1
in file hArxmlFileErrorMissingIsService\_SR\_3p2.arxml:48.
Specify the IsService attribute to be either true or false
```

In this example message, the file name is a hyperlink, and you can click the hyperlink to see the location of the error in the arxml file.

To help support the round trip of AUTOSAR elements between an AAT and the Simulink model-based design environment, Embedded Coder preserves AUTOSAR elements and their UUIDs across arxml import and export, as follows:

- When arxml files created by an AAT are imported into a Simulink model, AUTOSAR element information is preserved, including UUIDs (for Identifiables), properties, references, and packages.
- After import, you can view and edit AUTOSAR objects in a Simulink model window without losing the information imported from the AAT. For example, you can use the Configure AUTOSAR Interface dialog box to edit object name and property values (preserving the original object UUID), add new objects such as Interfaces and Ports (creating new UUIDs), and delete objects (retiring UUIDs). These actions do not perturb the imported objects and their relationships.

- When arxml files are exported from a Simulink model, the elements are generated back into arxml with their UUIDs and other information preserved.

As a result, the arxml files exported from Simulink can more easily be merged back into the AAT environment. Existing elements retain their UUIDs, while new elements created in Simulink get new UUIDs.

The AUTOSAR software component importer tool is implemented as an `arxml.importer` class. For a complete list of methods, see the `arxml.importer` class reference page.

Use `arxml.importer` methods in the following order:

- 1** Call the constructor `arxml.importer`, for example, `arxml.importer('mySoftwareComponentFile.arxml')`, to create an importer object that looks for atomic software components in the specified XML file. In the Command Window, you see reports describing identified atomic software components. You can have multiple components. For example:

The file "mySoftwareComponentFile.arxml" contains:

```
1 Atomic-Software-Component-Type:
  '/ComponentType/complex_type_component'
3 CalPrm-Component-Type:
  '/ComponentType/MyCalibComp1'
  '/ComponentType/MyCalibComp2'
  '/ComponentType/MyCalibComp3'
```

To change the main file and update the list of components, use `arxml.importer.setFile`.

Each software component requires an `arxml.importer` object. For each `arxml.importer` object, specify the file that contains the software component that you want.

- 2** Use `arxml.importer.setDependencies` if you need to specify additional dependent XML files containing the information that completes the software component description (for example, data types, interfaces). You can specify a cell array of files or a single file.

Complete specifying dependencies only for components that you intend to import into Simulink.

3 To import a parsed atomic software component into a Simulink model, call one of the following methods. If you have not specified all dependencies for the components, you will see errors.

- `arxml.importer.createComponentAsSubsystem` — Creates and configures a Simulink subsystem skeleton corresponding to the specified atomic software component description.
- `arxml.importer.createComponentAsModel` — Creates and configures a Simulink model skeleton corresponding to the specified atomic software component description.

For example:

```
importer_obj.createComponentAsModel('/ComponentType/complex_type_component')
```

- `arxml.importer.createCalibrationComponentObjects` — Creates Simulink calibration objects corresponding to the specified AUTOSAR calibration component description.

For example:

```
[success] = createCalibrationComponentObjects(importer_obj,  
'/ComponentType/MyCalibComp1',  
'CreateSimulinkObject', true)
```

See also the limitation, “Cannot Import Internal Behavior” on page 17-92.

After you import your software component into Simulink, you can modify the skeleton model or subsystem. For parameters from a calibration component, after importing the parameters into the MATLAB workspace, assign the calibration parameters to block parameters in your model.

To configure AUTOSAR code generation options and XML export options, see:

- “Prepare a Model for AUTOSAR Code Generation” on page 17-43
- “Generate AUTOSAR Code and Description Files” on page 17-82
- “Configure AUTOSAR Options Programmatically” on page 17-88

To see how to import, modify, and export AUTOSAR Software Components, view the example [Import and Export an AUTOSAR Software Component](#).

Create an AUTOSAR Software Component in Simulink

As an alternative to importing an AUTOSAR Software Component from an AUTOSAR authoring tool (AAT), you can create an AUTOSAR software component in Simulink. To do this:

- 1 Open a Simulink model that is not configured for AUTOSAR.
- 2 Click **Simulation > Model Configuration Parameters** to open the Configuration Parameters dialog box.
- 3 On the **Code Generation** pane, use **System target file** to select the target for AUTOSAR code generation, `autosar.tlc`.
- 4 Go to the **Code Generation > AUTOSAR Code Generation Options** pane, and inspect the settings of the AUTOSAR code generation parameters to see if modifications are required.
- 5 Click the button **Configure AUTOSAR Interface**. This opens the **Create AUTOSAR Component?** dialog box, which offers two paths for creating an AUTOSAR software component:
 - **Create Default Component** — Automatically create an AUTOSAR component and bring it up in the Configure AUTOSAR Interface dialog box.
 - **Create Component Interactively** — Interactively create an AUTOSAR component using the AUTOSAR Component Builder dialog box.

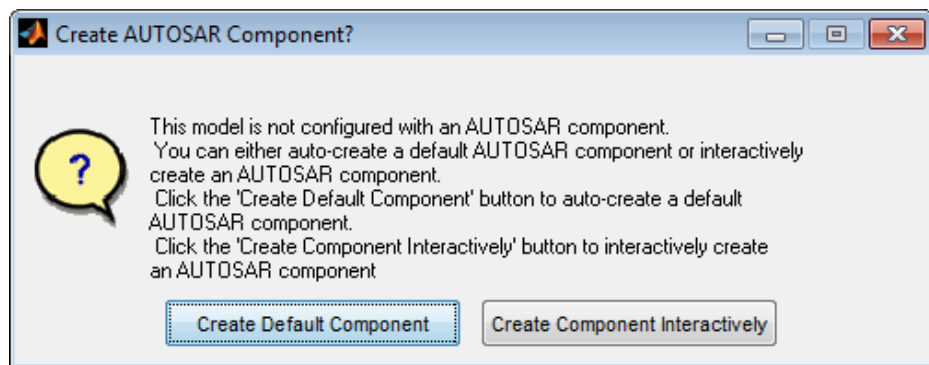

- 6 Click one of the two buttons. If you click **Create Default Component**, a new AUTOSAR component comes up in the Configure AUTOSAR Interface dialog box. For information about using this dialog box, see “Configure the AUTOSAR Interface” on page 17-43. If you click **Create Component Interactively**, the AUTOSAR Component Builder dialog box opens.
- 7 In the initial view of the AUTOSAR Component Builder dialog box, you specify:
 - Path for the AUTOSAR component package.
 - Name for the AUTOSAR component.
 - AUTOSAR component type: Application for an AUTOSAR application software component, or Sensor Accuator for an AUTOSAR sensor/actuator software component.

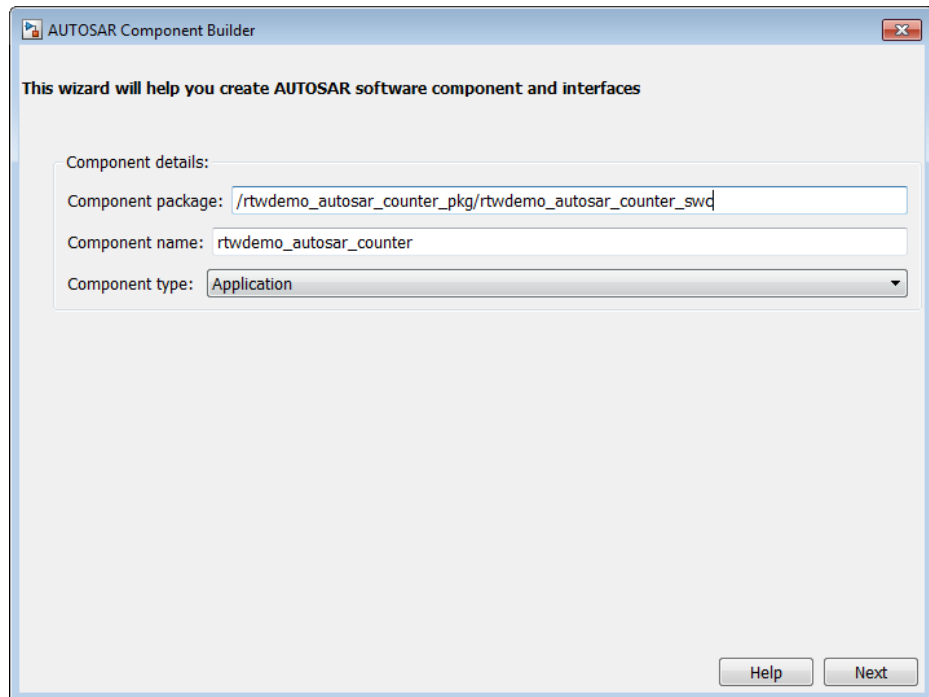

Click **Next** to go to the Add Interfaces view.

- 8** In the Add Interfaces view of the AUTOSAR Component Builder dialog box, you can:
- Modify the name of the Interface package associated with the AUTOSAR component.
 - Use the **Add Interface** button to add more Sender or Receiver interfaces to the displayed list.
 - Use the **Remove Interface** button to remove a selected Sender or Receiver interface.
 - For each listed interface, edit the name, edit the number of data elements it contains, and select whether the interface is a service.

Note If you opened this dialog box from the Configure AUTOSAR Interface dialog box, the **Add Interface** and **Remove Interface** buttons do not appear.

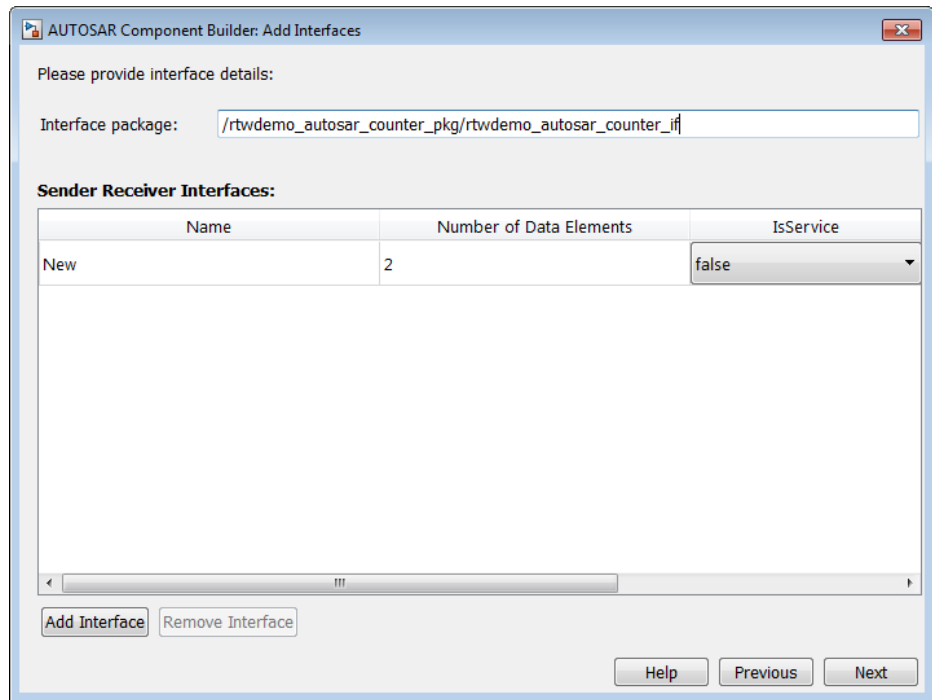

Click **Next** to go to the Add Ports view. (If you opened this dialog box from the Configure AUTOSAR Interface dialog box, click **Add**.)

- 9 In the Add Ports view of the AUTOSAR Component Builder dialog box, you can:
- Use the **Add Port** button to add more ports to the displayed list.
 - Use the **Remove Port** button to remove a selected Sender-Receiver interface.
 - For each listed port, edit the name, select the associated interface, and select whether the port type is Sender or Receiver.

Note If you opened this dialog box from the Configure AUTOSAR Interface dialog box, the **Add Port** and **Remove Port** buttons do not appear, and only one port is listed.

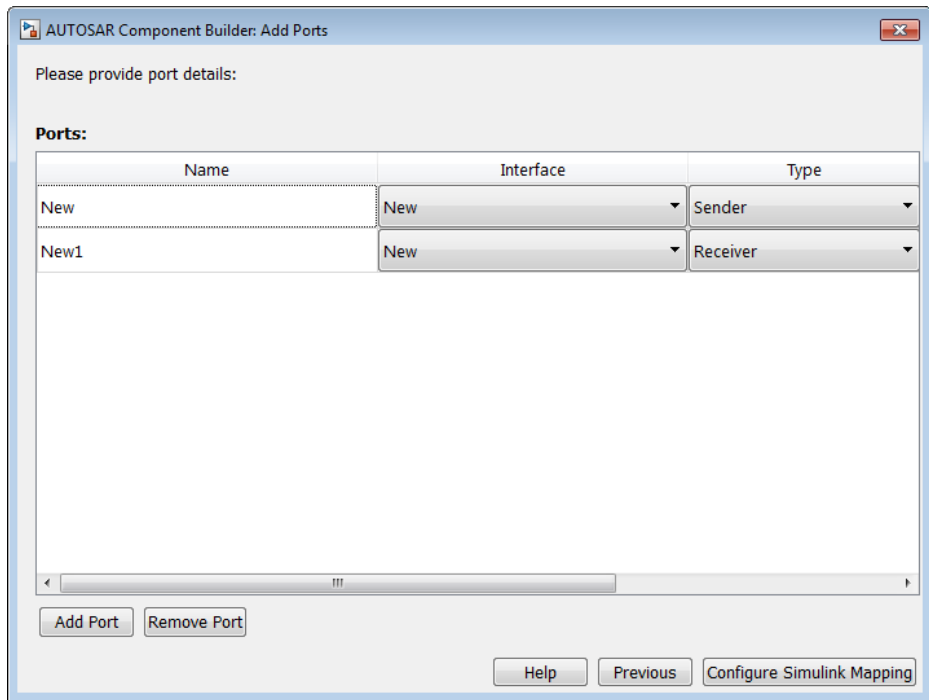

Click **Configure Simulink Mapping** to open the Configure AUTOSAR Interface dialog box. To continue from this point, see “Configure the AUTOSAR Interface” on page 17-43. (If you opened this dialog box from the Configure AUTOSAR Interface dialog box, click **Add**.)

Prepare a Model for AUTOSAR Code Generation

In this section...

- “Configure the AUTOSAR Interface” on page 17-43
- “Configure Single Runnables for DataReceivedEvents” on page 17-57
- “Configure Ports for Basic Software and Error Status Receivers” on page 17-60
- “Configure Client-Server Communication” on page 17-61
- “Configure Multiple Runnables” on page 17-69
- “Configure Calibration Parameters” on page 17-77
- “Use Data Store Memory Blocks to Specify Per-Instance Memory” on page 17-79
- “Modify and Validate an Existing AUTOSAR Interface” on page 17-80

Configure the AUTOSAR Interface

- “Map Simulink Model to AUTOSAR Software Component” on page 17-45
- “Configure AUTOSAR Software Components and Interfaces” on page 17-49

After you have imported an AUTOSAR software component into a Simulink model, using `arxml.importer`, or created a Simulink representation of an AUTOSAR software component, using the AUTOSAR Component Builder, open the model and use the Configure AUTOSAR Interface dialog box to further develop the AUTOSAR component. The Configure AUTOSAR Interface dialog box provides two distinct views of the AUTOSAR component, which can be used separately and together to configure the AUTOSAR interface:

- Simulink-AUTOSAR Mapping Explorer — This view displays model inports, outports, and entry point functions in a tree format. Use this view to map model components and interfaces to AUTOSAR components and interfaces from a Simulink model perspective.
- AUTOSAR Properties Explorer — This view displays AUTOSAR components, S-R interfaces, and XML options in a tree format. Use this

view to configure AUTOSAR elements from an AUTOSAR component perspective.

In a model for which the AUTOSAR code generation target (`autosar.tlc`) has been selected, you can open the Configure AUTOSAR Interface dialog box by selecting **Code > C/C++ Code > Configure Model as AUTOSAR Component**.

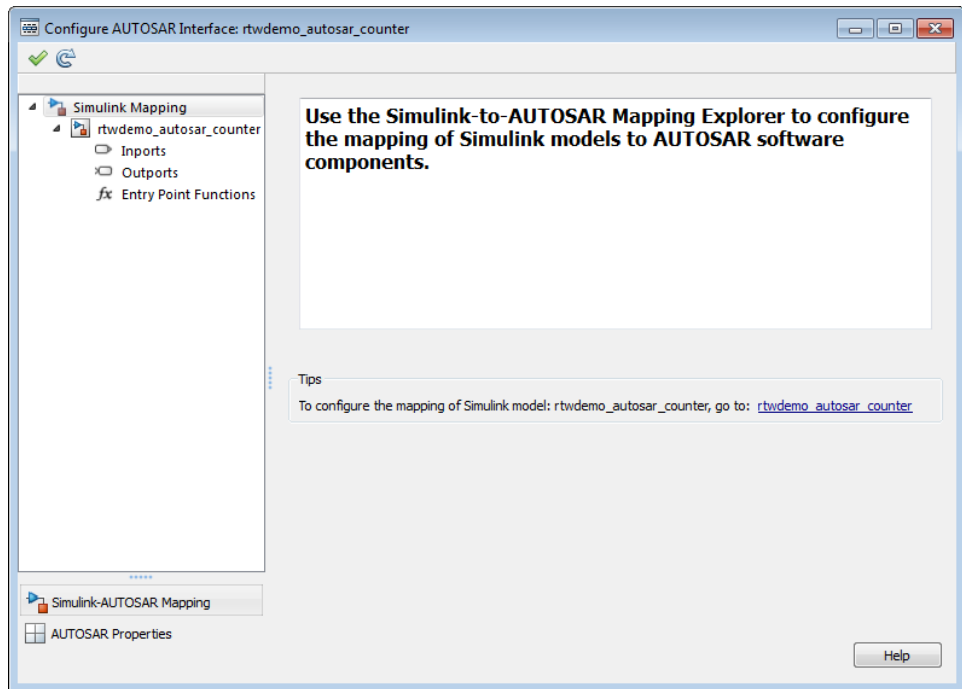

As you progressively configure the model representation of the AUTOSAR component, you can:

- Freely switch between the Simulink and AUTOSAR perspectives, by clicking **Simulink-AUTOSAR Mapping** or **AUTOSAR Properties**.
- Click the Validate icon  to validate the AUTOSAR interface configuration

- If you add a block in your Simulink model, click the Synchronize icon  to update the AUTOSAR interface configuration with content from the added block.
- Use the **Filter Contents** field (where available) to selectively display some elements, while omitting others, in the current view.

For more information on the Simulink-AUTOSAR Mapping Explorer, see “Map Simulink Model to AUTOSAR Software Component” on page 17-45. For more information on the AUTOSAR Properties Explorer, see “Configure AUTOSAR Software Components and Interfaces” on page 17-49.

Map Simulink Model to AUTOSAR Software Component

To map Simulink model elements to AUTOSAR software component elements:

- 1 Open a model for which the AUTOSAR code generation target (`autosar.tlc`) has been selected.
- 2 Open the Configure AUTOSAR Interface dialog box by selecting **Code > C/C++ Code > Configure Model as AUTOSAR Component**. If the Simulink-AUTOSAR Mapping Explorer is not already selected, click **Simulink-AUTOSAR Mapping**. The model tree in the top-level view shows the types of Simulink elements that can be mapped to AUTOSAR component elements:
 - A Simulink model can be mapped to an AUTOSAR component.
 - A Simulink inport or outport can be mapped to a data element of an AUTOSAR port, with a specific data access mode.
 - A Simulink entry-point function can be mapped to an AUTOSAR runnable.

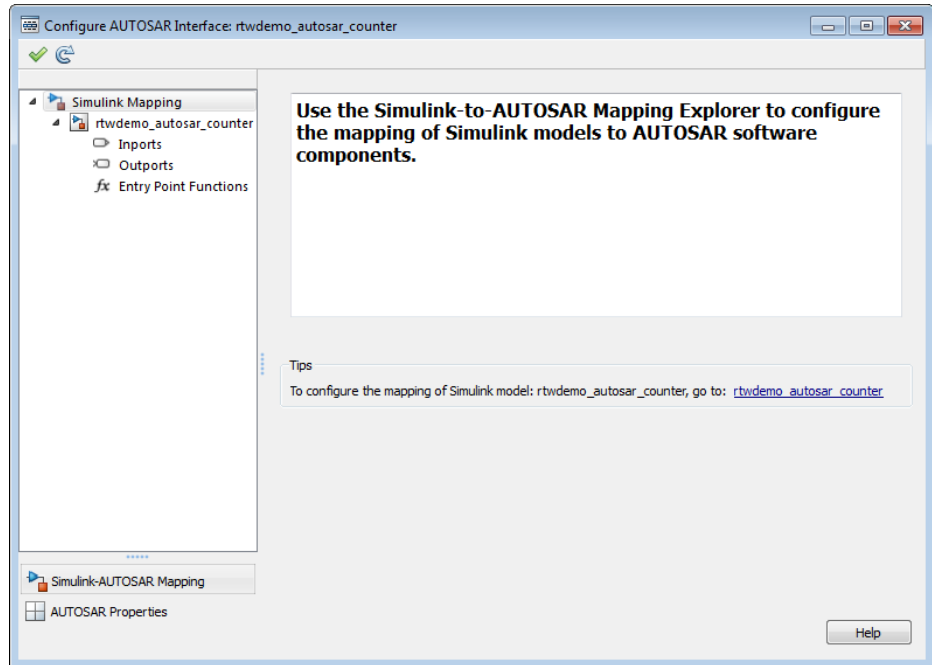

In the left-hand pane, under **Simulink-Mapping**, select the model name.

- 3 The model view of the Simulink-AUTOSAR Mapping Explorer displays the model name and the name of the AUTOSAR component to which the model is being mapped.

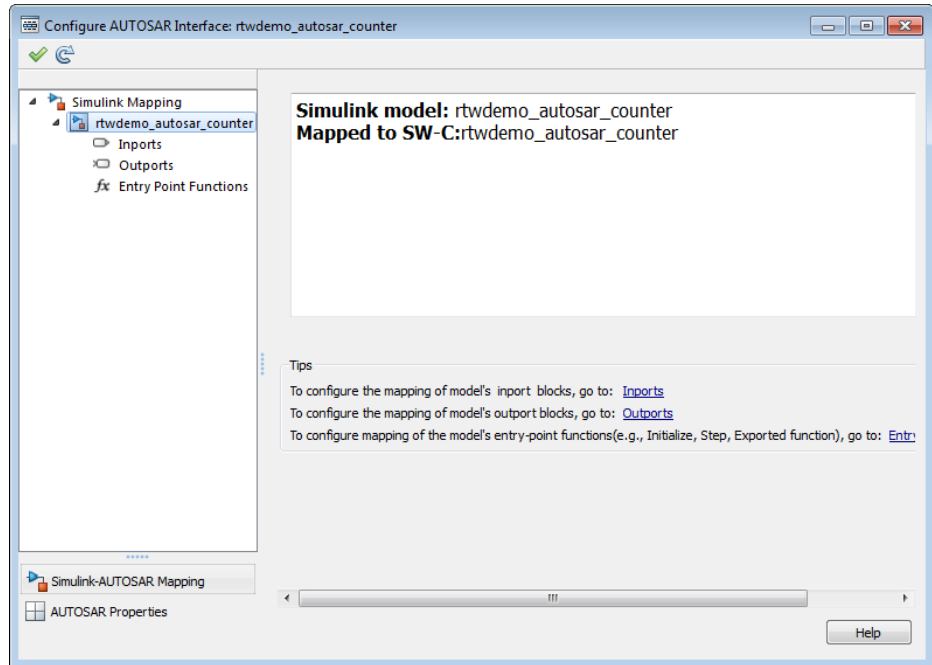

In the left-hand pane, under the model name, select **Inports**.

- 4 The Inports view of the Simulink-AUTOSAR Mapping Explorer maps each Simulink inport to a data element of an AUTOSAR port. You can:
 - Map a Simulink inport by selecting the inport and then selecting menu values for an AUTOSAR Port and an AUTOSAR Element. (In this example, there is only one available mapping.)
 - Select a port and then select a menu value for its AUTOSAR port data access mode: `ImplicitReceive`, `ExplicitReceive`, `QueuedExplicitReceive`, `BasicSoftwarePort`, or `ErrorStatus`.

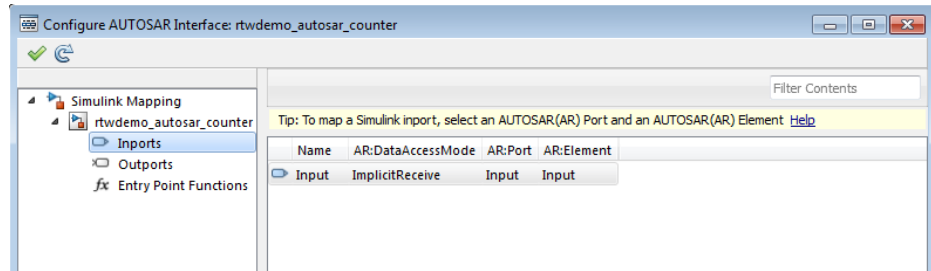

In the left-hand pane, select **Outports**.

- 5 The Outports view of the Simulink-AUTOSAR Mapping Explorer maps each Simulink outpost to a data element of an AUTOSAR port. You can:
 - Map a Simulink outpost by selecting the outpost and then selecting menu values for an AUTOSAR Port and an AUTOSAR Element. (In this example, there is only one available mapping.)
 - Select a port and then select a menu value for its AUTOSAR port data access mode: `ImplicitSend`, `ExplicitSend`, or `BasicSoftwarePort`.

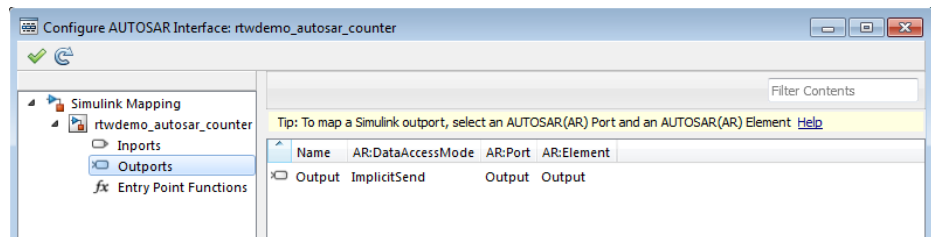

In the left-hand pane, select **Entry Point Functions**.

- 6 The Entry Point Functions view of the Simulink-AUTOSAR Mapping Explorer maps each Simulink entry-point function to an AUTOSAR runnable. You can map a Simulink entry-point function by selecting the entry point function and then selecting a menu value for an AUTOSAR runnable.

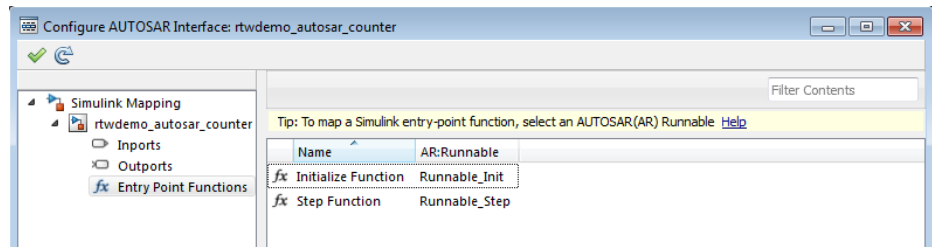

- 7 Click the Validate icon  to validate the AUTOSAR interface configuration. If errors are reported, address them and then retry validation.

Configure AUTOSAR Software Components and Interfaces

To configure AUTOSAR elements from an AUTOSAR component perspective in Simulink:

- 1 Open a model for which the AUTOSAR code generation target (autosar.tlc) has been selected.
- 2 Open the Configure AUTOSAR Interface dialog box by selecting **Code > C/C++ Code > Configure Model as AUTOSAR Component**. If the AUTOSAR Properties Explorer is not already selected, click **AUTOSAR Properties**. The top-level view shows the types of AUTOSAR elements for which properties can be configured — atomic software components, S-R interfaces, and XML options.

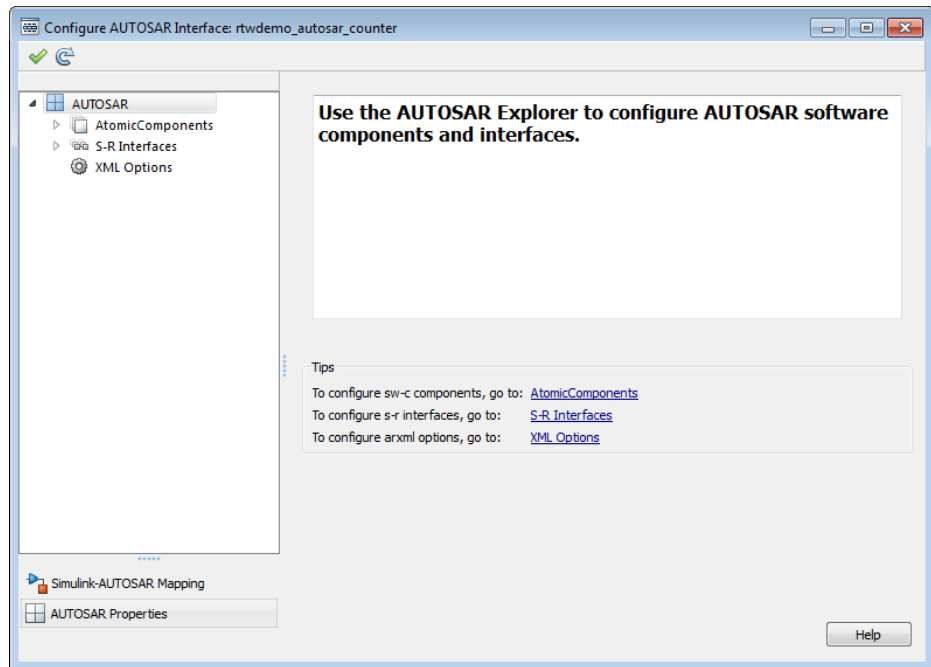

In the left-hand pane, under **AUTOSAR**, select **AtomicComponents**.

- 3 The Atomic Components view of the AUTOSAR Properties Explorer displays atomic components and their types. You can:
 - Select an AUTOSAR component and then select a menu value for its kind: Application for an AUTOSAR application software component, or Sensor Accuator for an AUTOSAR sensor/actuator software component.
 - Rename an AUTOSAR component by clicking its name and then editing the name string.

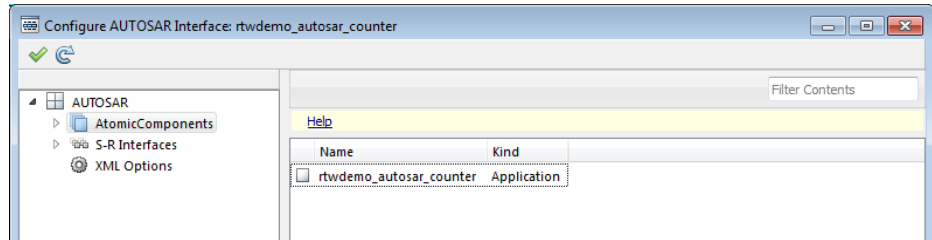

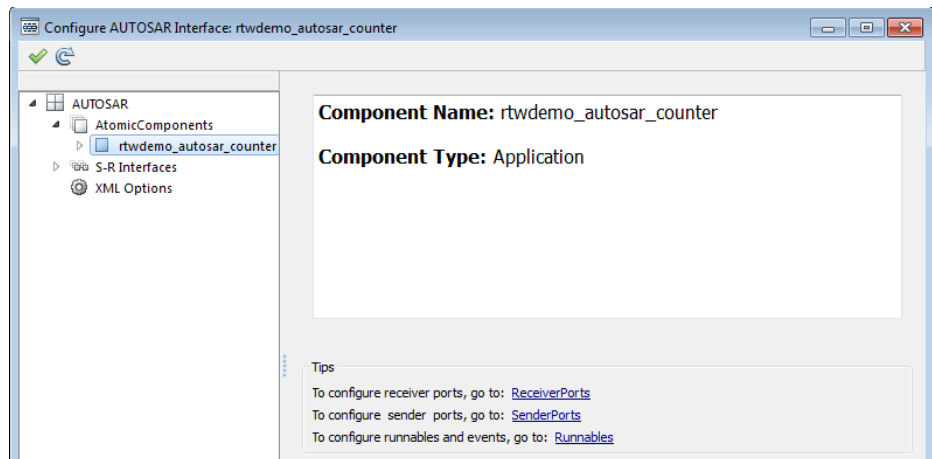

In the left-hand pane, expand **AtomicComponents** and select an AUTOSAR component.

- The component view of the AUTOSAR Properties Explorer displays the name and type of the selected component, and lists the types of AUTOSAR component elements for which properties can be configured — receiver ports, sender ports, and runnables.





In the left-hand pane, expand the component and select **ReceiverPorts**.

- The Receiver Ports view of the AUTOSAR Properties Explorer lists receiver ports and their properties. You can
 - Select an AUTOSAR receiver port and then select a menu value for its interface type: Input or Output.

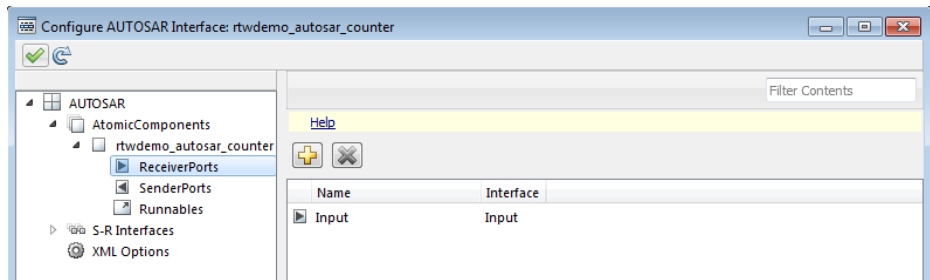
- Rename an AUTOSAR receiver port by clicking its name and then editing the name string.
- Click the Add icon  to open an AUTOSAR Component Builder dialog box to add a port. The Add Ports dialog box lets you add a receiver port for input or output.
- Select a port and then click the Delete icon  to remove it.



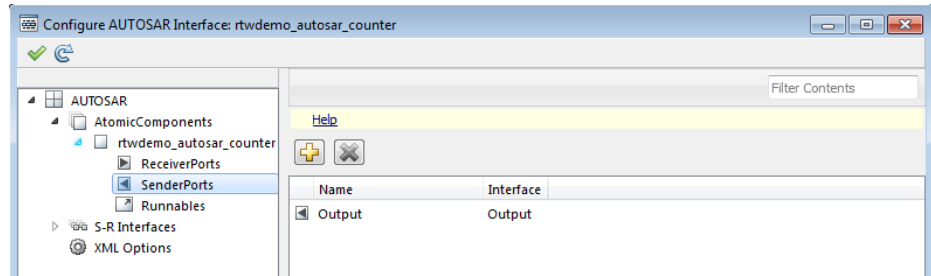

In the left-hand pane, select **SenderPorts**.

- 6 The Sender Ports view of the AUTOSAR Properties Explorer lists sender ports and their properties. You can:
 - Select an AUTOSAR sender port and then select a menu value for its interface type: Input or Output.
 - Rename an AUTOSAR sender port by clicking its name and then editing the name string.
 - Click the Add icon  to open an AUTOSAR Component Builder dialog box to add a port. The Add Ports dialog box lets you add a sender port for input or output.
 - Select a port and then click the Delete icon  to remove it.





In the left-hand pane, select **Runnables**.

7 The Runnables view of the AUTOSAR Properties Explorer lists runnables for the AUTOSAR component. You can:

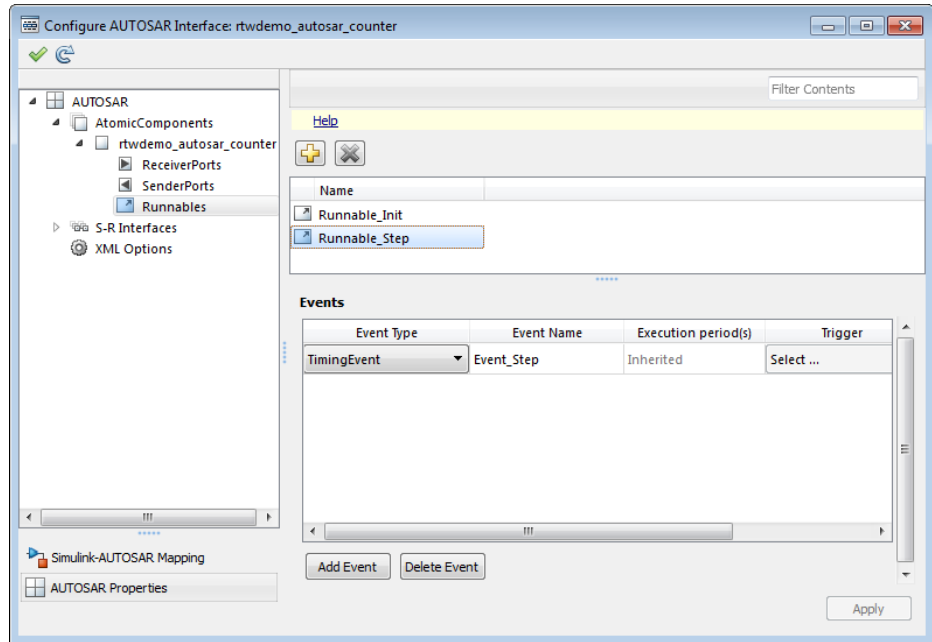
- Rename an AUTOSAR runnable by clicking its name and then editing the name string.
- Click the Add icon  to add an AUTOSAR runnable.
- Select an AUTOSAR runnable and then click the Delete icon  to remove it.
- Select a runnable to see its list of associated events. The **Events** pane lists each AUTOSAR event with its type (`TimingEvent` or `DataReceivedEvent`), name (modifiable string), execution periods (for `TimingEvent` only), and trigger (for `DataReceivedEvent` only). You can use the buttons **Add Event** and **Delete Event** to add or delete events from a runnable.



In the left-hand pane, select **S-R Interfaces**.

- 8 The S-R Interfaces view of the AUTOSAR Properties Explorer lists AUTOSAR sender and receiver interfaces and their properties. You can
 - Select an AUTOSAR interface and then select a menu value to specify whether or not it is a service.
 - Rename an AUTOSAR interface by clicking its name and then editing the name string.
 - Click the Add icon  to open an AUTOSAR Component Builder dialog box to add one or more interfaces. The Add Interfaces dialog box lets you specify the name of the new interface, the number of associated data elements to create, whether or not the interface is a service, and the path of the Interface package associated with the AUTOSAR component.
 - Select an interface and then click the Delete icon  to remove it.

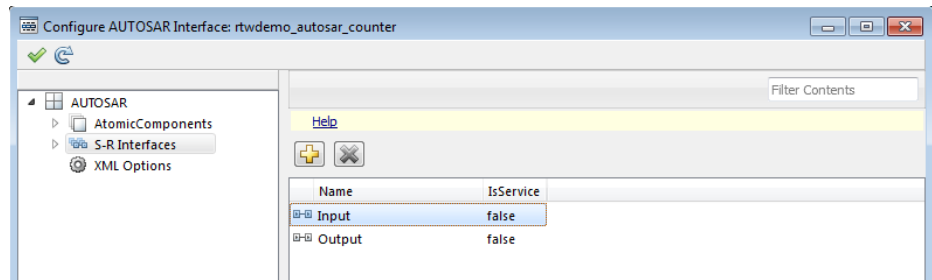



In the left-hand pane, expand **S-R Interfaces** and select an AUTOSAR interface from the list.

- 9 The interface view of the AUTOSAR Properties Explorer displays the name of the selected interface, whether or not it is a service, and shows the type of AUTOSAR interface element for which properties can be configured — data elements.



In the left-hand pane, expand the selected interface and select **DataElements**.

- 10 The Data Elements view of the AUTOSAR Properties Explorer lists interface data elements and their properties. You can
 - Select an AUTOSAR interface data element and edit the name value.
 - Click the Add icon  to add a data element.

- Select a data element and then click the Delete icon  to remove it.

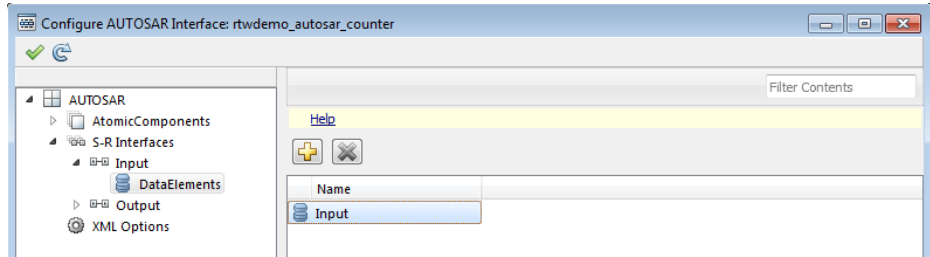

In the left-hand pane, select **XML Options**.

11 The XML Options view of the AUTOSAR Properties Explorer displays XML export parameters and their values. You can:

- Specify the file packaging for exported XML by selecting a menu value: **Modular** or **Single file**. The following table shows which XML files are generated based on the value selection.

Exported XML file packaging Value	File Name	Description
Modular	<i>modelName</i> _behavior.xml	Specifies the software component internal behavior
	<i>modelName</i> _implementation.xml	Specifies the software component implementation
	<i>modelName</i> _interface.xml	Specifies the software component interfaces, including extra interfaces
	<i>modelName</i> _component.xml	Specifies the software component type, including additional ports added to the Simulink model
	<i>modelName</i> _datatype.xml	Specifies the software component data types, including any modified or additional data types
Single file	<i>modelName</i> .xml	Contains all specifications

- Specify paths for the AUTOSAR Component Package, Datatype Package, and Interface Package.
- Specify qualified names for the AUTOSAR Internal Behavior Name and Implementation Name.

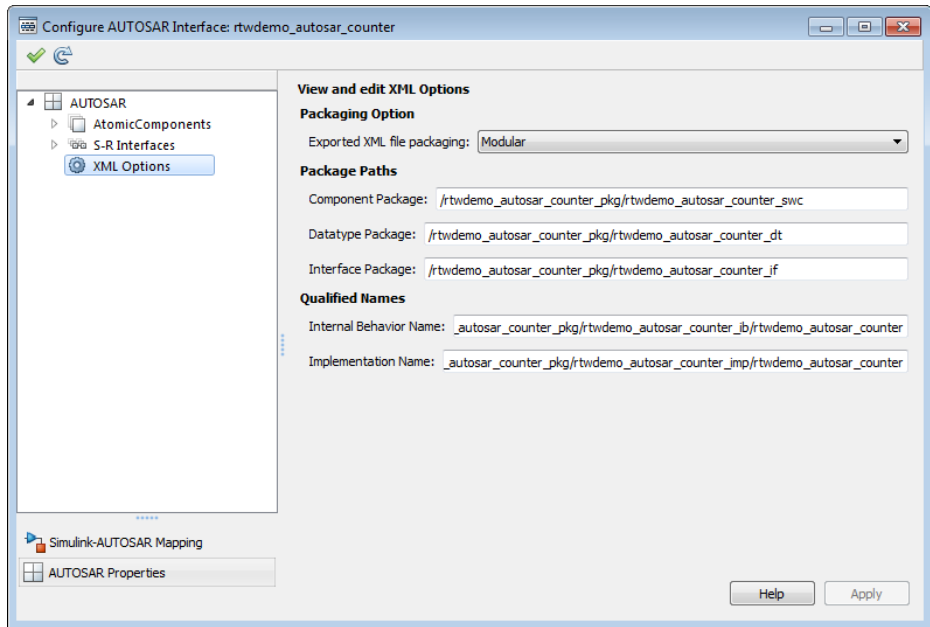

- 12** Click the Validate icon  to validate the AUTOSAR interface configuration. If errors are reported, address them and then retry validation.

Configure Single Runnables for DataReceivedEvents

The AUTOSAR Runtime Environment uses the event type *DataReceivedEvent* to trigger a runnable only when the value of a received data element is updated.

The software supports two data access modes that enable DataReceivedEvents to act as triggers, *ExplicitReceive* and *QueuedExplicitReceive*. The latter, in principle, allows the queuing of events. However, by default, the software

restricts the queue length to one event only. If you want a different queue length, you must edit the generated XML file.

To create a runnable trigger with a DataReceivedEvent:

- 1** Under **Configure AUTOSAR Interface**, select the **Input/Output** tab.
- 2** If you want an input data signal to be a trigger (for example, Input) set **Data Access Mode** for the corresponding inport to **ExplicitReceive** or **QueuedExplicitReceive**.

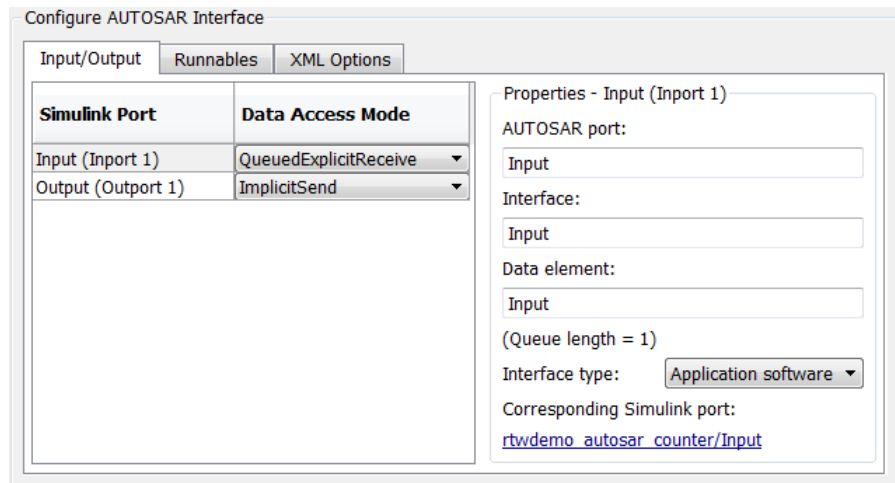

- 3** Select the **Runnables** tab. To create a new trigger event, click **Add Event**. By default, from the **Event Type** drop-down list, the software selects **DataReceivedEvent**.

Configure AUTOSAR Interface

Input/Output Runnables XML Options

Initialize runnable name: Runnable_Init

Runnable name: Runnable_Step

Event Type	Event Name	Execution period	Trigger Port
TimingEvent	Event_Step	Inherited	
DataReceivedEvent	Event		Select ...

Add Event Delete Event

- 4** In the **Event Name** column, specify an event name.
- 5** In the **Trigger Port** column, from the drop-down list, select the Simulink port, for example, Input.
- 6** To create an additional trigger event, repeat steps 3 – 5. You can remove a trigger event by selecting the event row and clicking **Delete Event**.
- 7** To verify that you have configured the event triggers, click **Validate**.

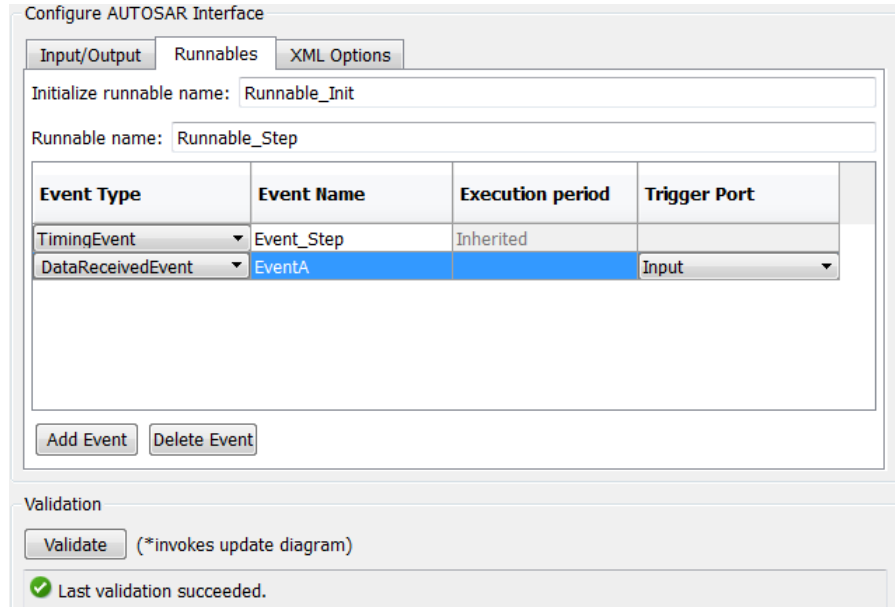

Note If you define a DataReceivedEvent in a top-model or right-click build configuration, you should specify sample time independence for the model, that is, you should set the **Periodic sample time constraint** on the **Solver** configuration parameters dialog pane to **Ensure sample time independent**. This action checks that the generated code can be executed at non-periodic rates, for example, asynchronously. However, if you know the execution context, for example, the data triggers periodically, then you do not have to specify sample time independence.

Configure Ports for Basic Software and Error Status Receivers

You can configure ports to access AUTOSAR services and device drivers (AUTOSAR basic software), and to access communication error status in your model. You can configure ports programmatically or by using the AUTOSAR Model Interface dialog box. To open the dialog box, right-click a subsystem and select **C/C++ Code > Configure Subsystem as AUTOSAR Component**.

In the dialog box, you can specify the **Data Access Mode** of every port.

- Designate inports and outports as access points to basic software.

If you select **Basic Software**, specify the service name, operation, and interface. The service name and operation must be valid AUTOSAR identifiers, and the service interface must be a valid path of the form `AUTOSAR/Service/servicename`.

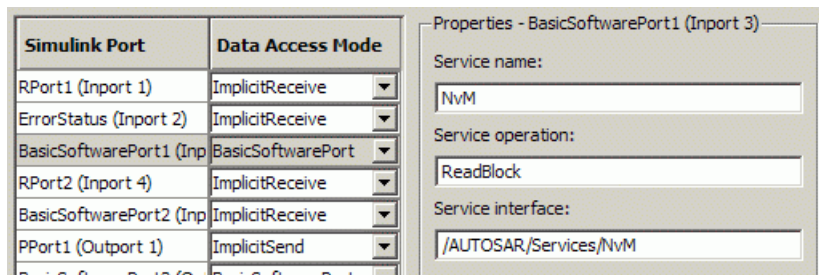

After you export your AUTOSAR components, you must include your service interface definition XML file to import these components into an authoring tool.

- Designate inports to receive error status.

If you select **Error Status** for an inport, you must select the other port (of mode Implicit or Explicit Receive) to listen for error status. Error status ports must use `uint8` data type (or an alias).

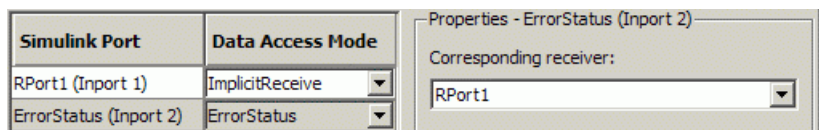

Configure Client-Server Communication

- “Configure a Server Operation” on page 17-63
- “Configure the Invoke AUTOSAR Server Operation Block” on page 17-65
- “Create Configurable Subsystems from a Client-Server Interface” on page 17-67

- “Simulate and Generate Code for Client-Server Communication” on page 17-68

AUTOSAR allows client-server communication between:

- Application software components
- An application software component and Basic Software

An AUTOSAR Client-Server Interface defines the interaction between a software component that *provides* the interface and a software component that *requires* the interface. The component that provides the interface is the server. The component that requires the interface is the client.

In Simulink, you can:

- Configure your model to implement a server operation. When you build your model, you generate AUTOSAR-compliant code and XML description files, including a client-server interface. See “Configure a Server Operation” on page 17-63.
- Configure a client port for your model using an Invoke AUTOSAR Server Operation block that references a client-server interface. When you build your model, you generate AUTOSAR-compliant code and XML description files for your client port. See “Configure the Invoke AUTOSAR Server Operation Block” on page 17-65.

Once you create a client-server interface, you can generate a Simulink library of configurable, client-server subsystems that reference the:

- Invoke AUTOSAR Server Operation block for code generation
- Server operation model block for simulation

For information on how to generate this library, see “Create Configurable Subsystems from a Client-Server Interface” on page 17-67

You can deploy the client-server subsystem in a Simulink model and, using the Mode Switch for Invoke AUTOSAR Server Operation, run the model in either a simulation or code-generation mode. See “Simulate and Generate Code for Client-Server Communication” on page 17-68.

For an example on generating and using an AUTOSAR Client-Server Interface, see `rtwdemo_autosar_clientserver_script`.

Configure a Server Operation

In the Configure AUTOSAR Interface dialog box, you can configure your Simulink model as a server operation. Then you can generate AUTOSAR-compliant code and XML files, including the client-server interface.

- 1 Select the **Configure I/O for server operation** check box. The **Input/Output** tab becomes the **Server Operation** tab.

The screenshot shows the 'Configure AUTOSAR Interface' dialog box. The 'Server Operation' tab is selected. The 'Configure I/O for server operation' checkbox is checked. The 'Component type' is set to 'Application'. The 'Server port name' is 'port'. The 'Operation prototype' is 'rtwdemo_autosar_server_operation(IN double upper, IN double inp'. The 'Interface name' is 'csinterface'. The 'Server type' is 'Application software'. The 'Validate' button is visible, and a message at the bottom says 'Press Validate to confirm the specification is valid for this model.'

Description
AUTOSAR compliant specification supports single rate and multirate single-tasking models.

Press Get Default Configuration to populate the initial I/O configuration.
Any runnable, event or XML option that is left blank will be filled with the default value.

Configure I/O for server operation

Component type: Application

Get Default Configuration (*invokes update diagram)

Configure AUTOSAR Interface

Server Operation | Runnables | XML Options

Server port name: port

Operation prototype: rtwdemo_autosar_server_operation(IN double upper, IN double inp

Interface name: csinterface

Server type: Application software

Validation

Validate (*invokes update diagram)

Press Validate to confirm the specification is valid for this model.

OK Cancel Help Apply

- 2 Click **Get Default Configuration** to populate the controls for your model.

The runnable names, XML properties, and I/O configuration are initialized. If you click **Get Default Configuration** again later, only the I/O configurations are reset to default values.

On the **Configure AUTOSAR Interface** pane, use the controls to change your AUTOSAR code generation options and XML export options.

- 3 On the **Server Operation** tab, specify the following:
 - **Server port name.** Use a valid AUTOSAR short-name identifier.
 - **Operation prototype .** The names of the prototype and its arguments must be valid AUTOSAR short-name identifiers, for example, `rtwdemo_autosar_server_operation(IN double upper, IN double input, IN double lower, OUT double output)`.
 - **Interface name.** The path reference of the client-server interface. Use a valid AUTOSAR short-name path, for example, `csinterface`.
 - **Server type.** From the drop-down list, select either `Application software` or `Basic software`.
- 4 On the **Runnables** tab, specify the names of your initial and periodic runnables, for example, `Runnable_Init` and `Runnable_Step`.

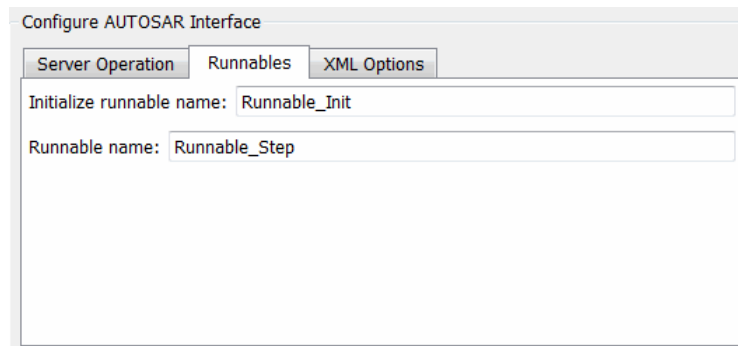

- 5 On the **XML Options** tab, specify:

- a The form of your **Exported XML file packaging**. Select **Modular** (default) if you want to publish the XML descriptions as separate files. If you want to combine the XML descriptions, select **Single file**.
- b The names and package paths of the XML files that you publish when you generate code.

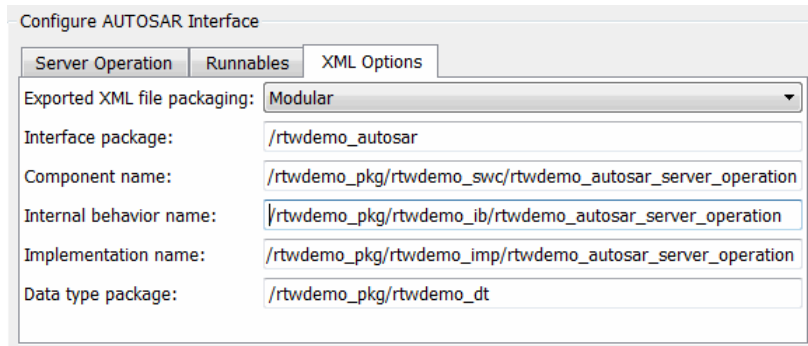

See “Export AUTOSAR Software Component” on page 17-85.

- 6 After you configure your options, click **Validate**, which calls `runValidation`. If a problem occurs, you see messages describing why the configuration is invalid. See also “Modify and Validate an Existing AUTOSAR Interface” on page 17-80.
- 7 If validation succeeds, click **OK** to return to the Configuration Parameters dialog box.
- 8 Save your model.
- 9 To generate AUTOSAR-compliant code and XML files, select **Code > C/C++ Code > Build Model**.

Configure the Invoke AUTOSAR Server Operation Block

You can use the Invoke AUTOSAR Server Operation block in your Simulink model to configure a client port (that accesses either application software or AUTOSAR Basic Software). You can then build the model to generate AUTOSAR-compliant code and XML files.

- 1 Drag an Invoke AUTOSAR Server Operation block into your model.

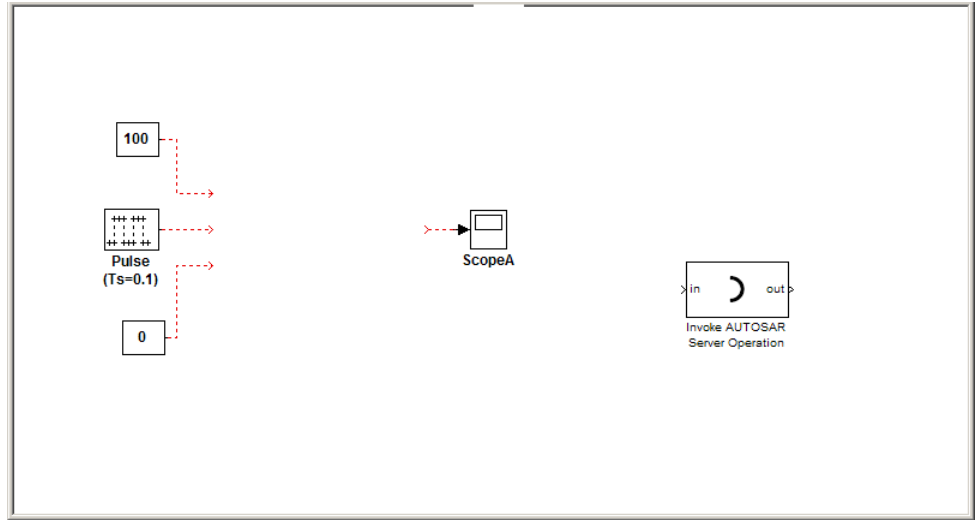

- 2 Double-click the block to open the Invoke AUTOSAR Server Operation dialog box. Specify the following:

- **Client port name.** A valid AUTOSAR short-name identifier.
- **Operation prototype.** The names of the prototype and its arguments must be valid AUTOSAR short-name identifiers, for example, `rtwdemo_autosar_server_operation(IN double upper, IN double input, IN double lower, OUT double output)`.
- **Interface path.** The path reference of the client-server interface. You must use a valid AUTOSAR short-name path, for example, `/AUTOSAR/Interface`.
- **Server type.** From the drop-down list, select either `Application software` or `Basic software`.
- **Show error status.** If you want the client port to receive the error status of client-server communication, select this check box.
- **Sample time.** Set this parameter to `-1` to inherit the sample time.

- 3 Click **OK**. Your Invoke AUTOSAR Server Operation block is updated.

- 4** Connect the updated Invoke AUTOSAR Server Operation block to your model.

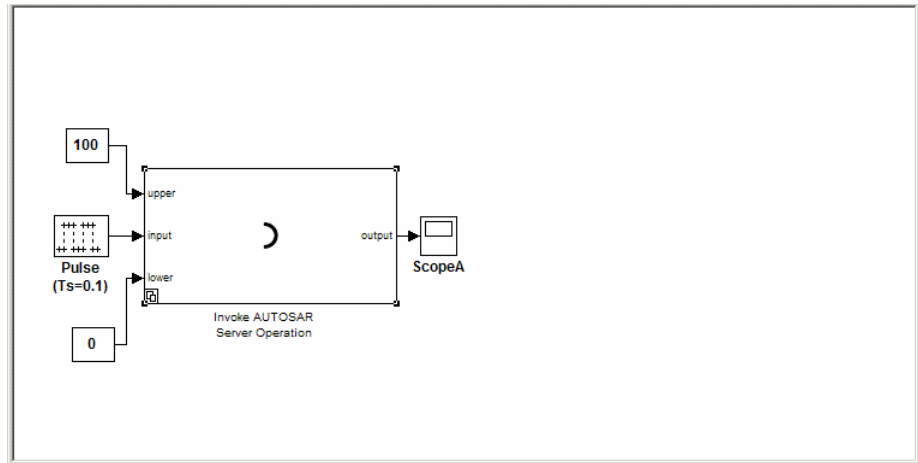

- 5** Select **Code > C/C++ Code > Build Model**. AUTOSAR-compliant code and XML files for the client port are generated.

Create Configurable Subsystems from a Client-Server Interface

You can generate a Simulink library of configurable subsystems by applying the `createOperationAsConfigurableSubsystems` method to the `arxml.importer` object with the client-server interface. For example:

```
% Create an AUTOSAR importer object
obj = arxml.importer('rtwdemo_autosar_csinterface.arxml');

% Create the client-server operation configurable subsystem library
obj.createOperationAsConfigurableSubsystems('/PortInterface/csinterface', ...
                                           'CreateSimulinkObject', false);
```

yield the following `PortInterface_csinterface` library.

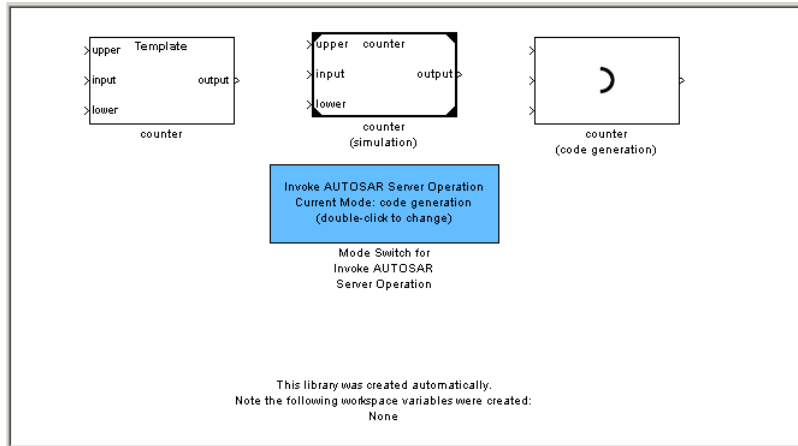

Simulate and Generate Code for Client-Server Communication

Use the Template block from the client-server subsystem library to construct a model that can be run in either code-generation or simulation mode.

- 1 Drag the Template block from the subsystem library into your model window and connect it to other blocks.
- 2 Place the Mode Switch for Invoke AUTOSAR Server Operation in your model window.

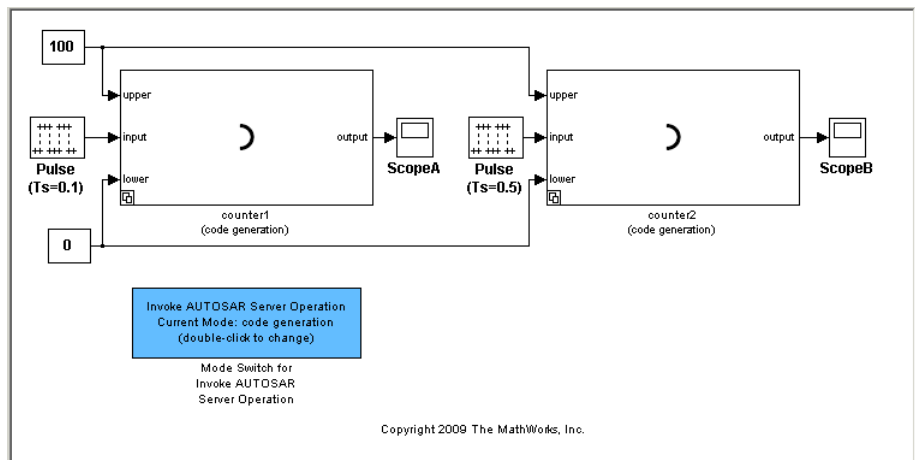

To simulate the model:

- 1 Double-click the Mode Switch for AUTOSAR Server Operation to change the current mode from `code generation` to `simulation`.
- 2 Select **Simulation > Run**.

To generate code for the model:

- 1 Double-click the Mode Switch for AUTOSAR Server Operation to change the current mode from `simulation` to `code generation`.
- 2 Select **Code > C/C++ Code > Build Model**.

Configure Multiple Runnables

You can use function-call subsystems within a wrapper subsystem to represent multiple runnables in a single AUTOSAR Software Component, and export each function-call subsystem as an AUTOSAR runnable.

If you group function-call subsystems within your wrapper subsystem into virtual subsystems, for example, to improve the graphical layout of your model, you can still export the function-call subsystems as AUTOSAR runnables. For information about virtual subsystems, see “Create a Subsystem” and “Virtual Blocks” in the Simulink documentation.

The software supports the following blocks within a wrapper subsystem:

- Data Store
- Display
- DocBlock
- From
- Goto
- Merge
- Model Info
- Scope
- Signal Specification

The software also supports the use of Simulink library blocks when creating multiple runnables from subsystems. See “Simulink Block Library Support for Multiple Runnables” on page 17-75.

Use the Configure AUTOSAR Interface dialog box to specify an AUTOSAR interface for each function-call subsystem that you want to export as a runnable. To open this dialog box, right-click the top-level wrapper subsystem and select **C/C++ Code > Configure Subsystem as AUTOSAR Component**. For information on how you configure multiple runnables, see:

- “Configure the AUTOSAR Interface” on page 17-43
- “Configure Inter-Runnable Variables” on page 17-70
- “Specify Execution Period” on page 17-72
- “Configure Multiple Runnables for DataReceivedEvents” on page 17-73

See also the AUTOSAR Code Generation for Multiple Runnable Entities example.

Configure Inter-Runnable Variables

Inter-runnable variables communicate primitive type data between runnables in a component. You define these inter-runnable variables by the signal lines that connect subsystems. For an example, see “Inter-Runnable Variables” on page 17-16.

By default, the software assigns the signal name to the exported inter-runnable variable. If you want to edit the name, before generating code, double-click the signal name and enter a new name. However, you can specify a different name for the exported variable. In addition, you can specify the data access mode of the inter-runnable variable.

To configure an inter-runnable variable:

- 1 In the Configure AUTOSAR Interface dialog box, select the **Inter-Runnable Variables** tab. You see Simulink signals with (default) inter-runnable names and data access modes.

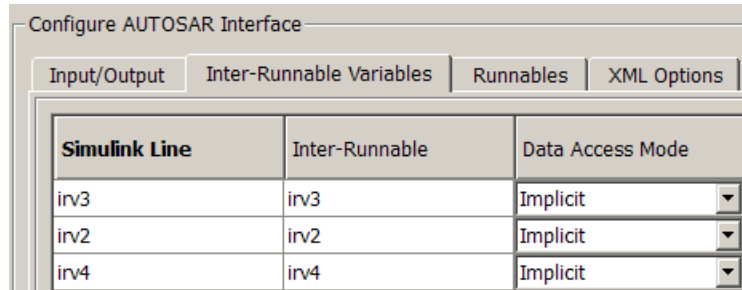

- 2 For each signal that you want to configure:
 - a In the **Inter-Runnable** cell, specify your AUTOSAR name for the exported variable.
 - b In the **Data Access Mode** cell, from the drop-down list, select either Explicit or Implicit (recommended).
- 3 Click **OK**.

When you select a signal, links appear under **Source ports for signal**.

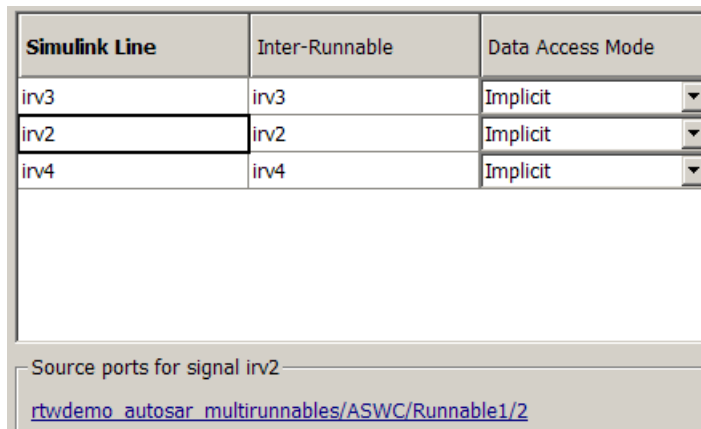

Each link corresponds to an instance of the signal and is associated with a source port in the Simulink model. Click a link to go to the corresponding model signal. For example, clicking [rtw.../ASWC/Runnable1/2](#) takes you to the following.

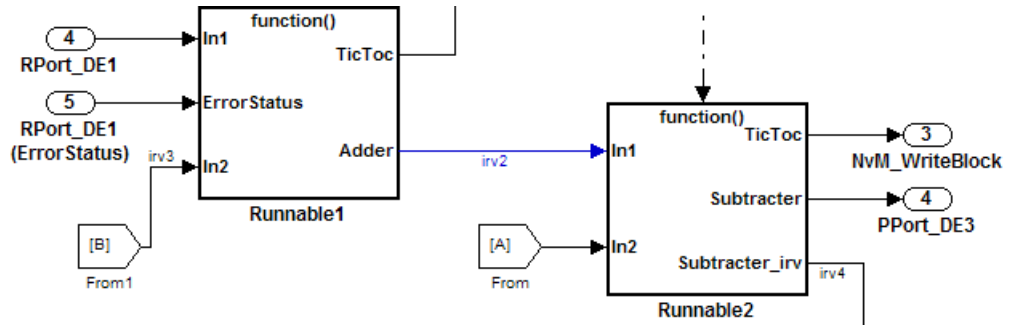

Specify Execution Period

You may need to use blocks that depend on time for a software component with multiple runnables, for example, the Discrete-Time Integrator block. In this case, you can specify a timer for each AUTOSAR runnable. The timer increments at each execution of the runnable.

Use the Configure AUTOSAR Interface dialog box to specify the execution period:

- 1** Select the **Runnables** tab.
- 2** Under **Runnable**, select a runnable, for example, **Runnable1**.
- 3** In the **Execution Period** cell for the TimingEvent of the runnable, enter the execution period.
- 4** Click **OK**.

Note The timer value in an AUTOSAR runnable is valid only if the runnable runs at a periodic rate that corresponds to the execution period that you specify. If the runnable runs at different rate, or does not begin executing at $t = 0$, then the timer value will be incorrect.

The timer data type generated depends on the execution period and the application life span. To specify the application life span:

- 1 Open the Configuration Parameters dialog box and select the **Optimization** pane.
- 2 In the **Application lifespan (days)** field, enter the required value.

Configure Multiple Runnables for DataReceivedEvents

The AUTOSAR Runtime Environment uses the event type `DataReceivedEvent` to trigger runnables only when the value of a received data element is updated.

The software supports two data access modes that enable `DataReceivedEvents` to act as triggers, `ExplicitReceive` and `QueuedExplicitReceive`. The latter, in principle, allows the queuing of events. However, by default, the software restricts the queue length to one event only. If you want a different queue length, you must edit the generated XML file.

To create runnable triggers with `DataReceivedEvents`:

- 1 Under **Configure AUTOSAR Interface**, select the **Input/Output** tab.
- 2 If you want an input data signal to be a trigger, for example, `RPort_DE1`, from the corresponding **Data Access Mode** drop-down list, select either `ExplicitReceive` or `QueuedExplicitReceive`.

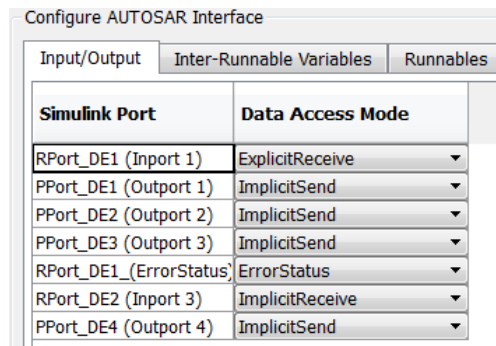

- 3 Select the **Runnables** tab. Under **Runnable**, select the runnable that you want to configure, for example, `Runnable1`.

Properties - Runnable1

Runnable name: Runnable1_Step

Event Type	Event Name	Execution period	Trigger Port
TimingEvent	Event_Runnable1	0.001	

- 4 Click **Add Event** to create a new trigger event. By default, from the **Event Type** drop-down list, the software selects `DataReceivedEvent` .
- 5 In the **Event Name** column, specify an event name.
- 6 In the **Trigger Port** column, from the drop-down list, select the Simulink port, for example, `RPort_DE1`.
- 7 To create an additional trigger event, repeat steps 4 – 6. You can remove a trigger event by selecting the event row and clicking **Delete Event**.
- 8 To verify that you have configured the trigger events, click **Validate**.

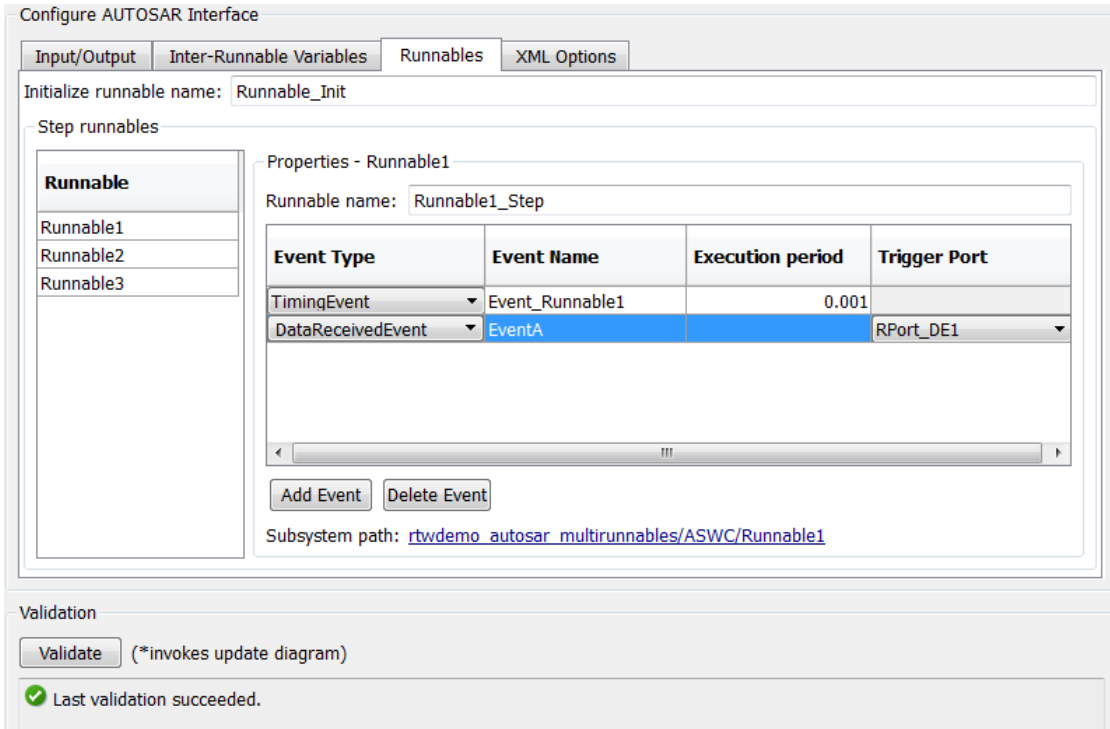

Note If a runnable contains blocks that use absolute time, for example, a discrete-time integrator, you should:

- Use a timing event to trigger the runnable
- Specify the execution period of the timing event to be the same as the sample time of the function-call trigger.

Simulink Block Library Support for Multiple Runnables

The software supports the use of Simulink library blocks when creating multiple runnables from subsystems. This support allows you to use:

- A wrapper subsystem (containing function-call subsystems) that is a link to a library block
- Function-call subsystems (within the wrapper subsystem) that are links to library blocks

Use the Configure AUTOSAR Interface dialog box to configure the linked subsystem. When you save the configured subsystem, the software saves the AUTOSAR configuration in the model file of the subsystem. The software does not store the AUTOSAR configuration of the subsystem as a *parametrized link* — see “Modify Linked Blocks”.

As an example, consider the example model `rtwdemo_autosar_multirunnables`, where the wrapper subsystem `ASWC` is replaced by `MRB_instance`, a link to a block from `my_autosar_lib`.

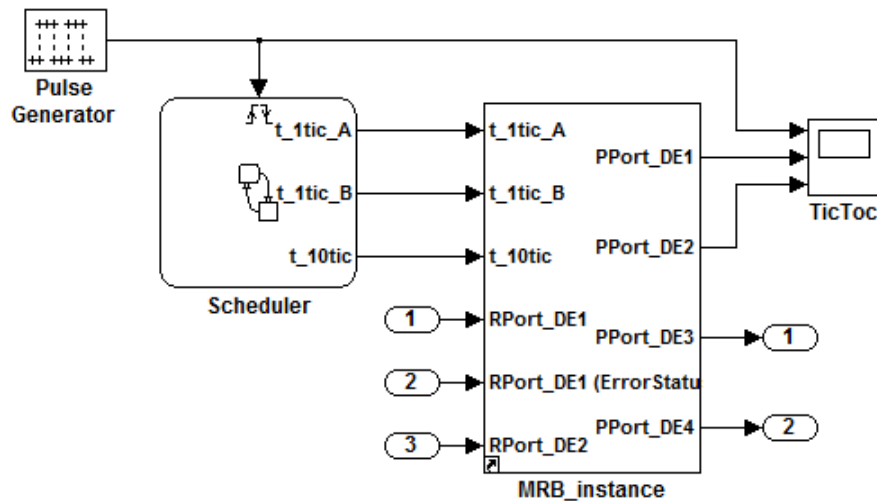

You can go to the block library by selecting `MRB_instance` and typing **Ctrl+L**.

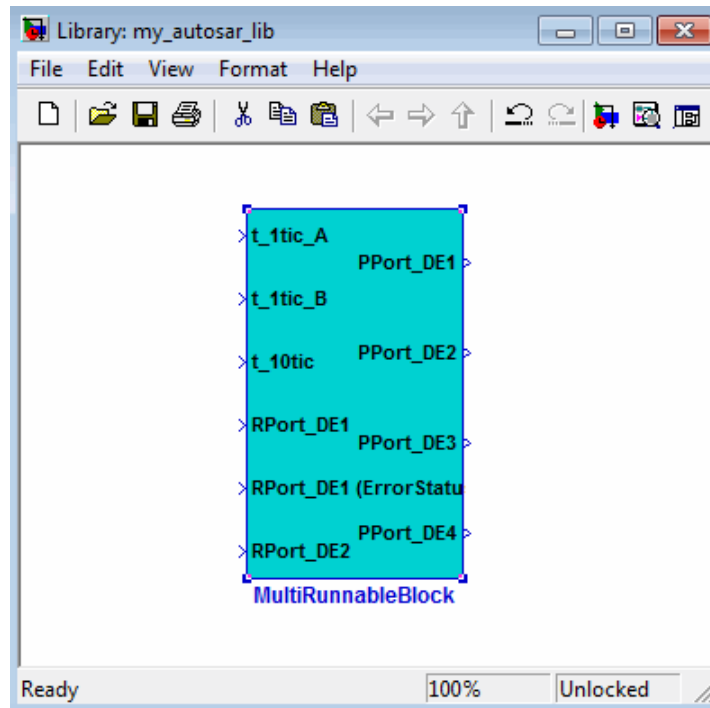

Configure Calibration Parameters

You can specify the type of calibration parameter that you export by configuring properties of the corresponding block parameter in the base workspace.

For example, to configure an *internal calibration parameter* for your AUTOSAR model:

- 1 Create an AUTOSAR.Parameter object.
 - a Open the Model Explorer (**Ctrl+H**).
 - b In the **Model Hierarchy** view, under **Simulink Root**, select **Base Workspace**.
 - c Select **Add > Add Custom**. The Model Explorer – Select Object dialog box opens.

- d** Specify a value in the **Object Name(s)** field, for example, myPrm.
 - e** From the **Object class** drop-down list, select AUTOSAR.Parameter.
 - f** Click **OK**. A new object myPrm appears in the base workspace.
- 2** In the **Contents** pane, select the object, for example, myPrm.
- 3** Using the **Dialog** pane, configure the following properties of this data object:
- **Value** — Specify a value for the calibration parameter. For an internal calibration parameter, this value represents the initial value.
 - **Data type**. For information about a creating data type, for example, a bus object data type, see “Specify Data Types Using Data Type Assistant” in the Simulink documentation.
 - **Storage class** — To specify an internal calibration parameter, from the drop-down list, select InternalCalPrm. You must then specify **Per instance behavior**. Select one of the following:
 - Parameter shared by all instances of the Software Component
 - Each instance of the Software Component has its own copy of the parameter

For information about the **Dialog** pane, see “Model Explorer: Property Dialog Pane” in the Simulink documentation.

- 4** In the Block Parameters dialog box, assign the data object to your model, for example:

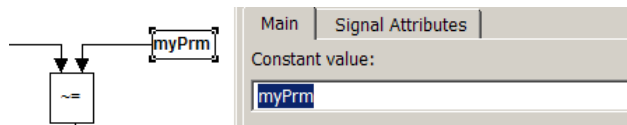

Before you generate code, you must:

- Open the Configuration Parameters dialog box and select **Optimization > Signals and Parameters > Inline parameters**.
- Clear **Code Generation > Ignore custom storage classes**.

Specifying these parameters allows the software to export the calibration parameters. See “Generate Code with Custom Storage Classes” on page 10-53.

For calibration component parameters, after you export your AUTOSAR components, you must include your calibration interface definition XML file to import the parameters into an authoring tool.

Note The software does not support the use of AUTOSAR calibration parameters within Model blocks.

Use Data Store Memory Blocks to Specify Per-Instance Memory

You can model per-instance memory through the use of Data Store Memory blocks together with an `AUTOSAR.Signal` data object. For a detailed example, see `rtwdemo_autosar_PIM_script`. The following is an outline of the required steps:

- 1 In the base workspace, create an `AUTOSAR.Signal` object.
- 2 Set the storage class of this object to `PerInstanceMemory`.
- 3 If required, set `needsNVRAMAccess` property to true.
- 4 Create a Data Store Memory block that references the `AUTOSAR.Signal` object. See Data Store Memory in the Simulink Reference documentation.

Note The software does *not* support per-instance memory modeling within a submodel.

When you build your model, the XML files that are generated define an exclusive area for each Data Store Memory block that references per-instance memory. Every runnable that accesses per-instance memory runs inside the corresponding exclusive area. If multiple AUTOSAR runnables have access to the same Data Store Memory block, the exported AUTOSAR specification enforces data consistency by using an AUTOSAR exclusive area.

With this specification, the runnables have mutually exclusive access to the per-instance memory global data, which prevents data corruption.

If you set `needsNVRAMAccess` to true, then a `SERVICE-NEEDS` entry (schema version 3.0) or `NVRAM-MAPPINGS` entry (schema version 2.1) is declared in XML files to indicate that the per-instance memory is a RAM mirror block and must be serviced by the NvM manager module.

Create an AUTOSAR.Signal Object

To create an `AUTOSAR.Signal` object in the base workspace:

- 1 Open the Model Explorer (**Ctrl+H**).
- 2 In the **Model Heirarchy** view, under **Simulink Root**, select **Base Workspace**.
- 3 Select **Add > Add Custom**. The Model Explorer – Select Object dialog box opens.
- 4 Specify a value in the **Object Name(s)** field, for example, `nvmImplicitRW`.
- 5 From the **Object class** drop-down list, select `AUTOSAR.Signal`.
- 6 Click **OK**. A new object `nvmImplicitRW` appears in the base workspace.

Modify and Validate an Existing AUTOSAR Interface

You can validate your AUTOSAR interface using the Configure AUTOSAR Interface dialog box. See “Configure the AUTOSAR Interface” on page 17-43. The following steps show how you can modify and validate your AUTOSAR interface *programmatically*:

- 1 Get the handle to an existing model-specific `RTW.AutosarInterface` object that is attached to your loaded Simulink model. Enter:

```
obj = RTW.getFunctionSpecification(modelName)
```

`modelName` is a string specifying the name of a loaded Simulink model, and `obj` returns a handle to an `RTW.AutosarInterface` object attached to the specified model.

Test the AUTOSAR interface object. Enter:

```
isa(obj, 'RTW.AutosarInterface')
```

This test must return 1. If the model does not have an AUTOSAR interface object, the function returns [].

- 2** To view and change items, use the AUTOSAR `get` and `set` functions listed in `RTW.AutosarInterface`.
- 3** Validate the function prototype using `RTW.AutosarInterface.runValidation`.
- 4** If validation succeeds, save your model and then generate code.

Generate AUTOSAR Code and Description Files

In this section...
“Select an AUTOSAR Schema” on page 17-82
“Specify Maximum SHORT-NAME Length” on page 17-83
“Configure AUTOSAR Compiler Abstraction Macros” on page 17-83
“Root-Level Matrix I/O” on page 17-85
“Export AUTOSAR Software Component” on page 17-85

Select an AUTOSAR Schema

The default AUTOSAR schema version is 3.1. If you need to change the schema version, you must do so before exporting your AUTOSAR Software Component. Embedded Coder supports the following AUTOSAR schema versions:

- 4.0 (4.0.2)
- 3.2 (3.2.1)
- 3.1 (3.1.4)
- 3.0 (3.0.2)
- 2.1 (XSD rev 0017)

To select a schema version:

- 1** Open the Configuration Parameters dialog box. In models that use the `autosar.tlc` system target file, **AUTOSAR Code Generation Options** appears in the tree.
- 2** Click **AUTOSAR Code Generation Options** to open the **AUTOSAR Code Generation Options** pane.
- 3** From the **Generate XML file for schema version** drop-down list, select the schema version that you require.

Specify Maximum SHORT-NAME Length

The AUTOSAR standard specifies that SHORT-NAME XML elements must not be greater than 32 characters in length. However, your authoring tool may support the use of longer elements, for example, to name ports and interfaces. The software allows you to specify the maximum length of your SHORT-NAME elements.

Before you build your model, in the **Code Generation > AUTOSAR Code Generation Options** pane of the Configuration Parameters dialog box, in the **Maximum SHORT-NAME length** field, specify the maximum length of your SHORT-NAME elements. You may specify a maximum length of up to 128 characters. The default is 32 characters.

Configure AUTOSAR Compiler Abstraction Macros

Compilers for 16-bit platforms (for example, Cosmic and Metrowerks for S12X or Tasking for ST10) use special keywords to deal with the limited 16-bit addressing range. The location of data and code beyond the 64 k border is selected explicitly by special keywords. However, if such keywords are used directly within the source code, then software must be ported separately for each microcontroller family, that is, the software is not platform-independent.

AUTOSAR specifies C macros to abstract compiler directives (near/far memory calls) in a platform-independent manner. These compiler directives, derived from the 16-bit platforms, enable better code efficiencies for 16-bit micro-controllers without separate porting of source code for each compiler. This approach allows your system integrator, rather than your software component implementer, to choose the location of data and code for each software component.

For more information on AUTOSAR compiler abstraction, see www.autosar.org.

Configure AUTOSAR Compiler Macro Generation

Before you build your model, in the **Code Generation > AUTOSAR Code Generation Options** pane of the Configuration Parameters dialog box, select **Use AUTOSAR compiler abstraction macros**.

When you build the model, the software applies compiler abstraction macros to global data and function definitions in the generated code.

For data, the macros are in the following form:

- `CONST(consttype, memclass) varname;`
- `VAR(type, memclass) varname;`

where

- *consttype* and *type* are data types
- *memclass* is a macro string `SWC_VAR` (*SWC* is the software component identifier)
- *varname* is the variable identifier

For functions (model and subsystem), the macros are in the following form:

- `FUNC(type, memclass) funcname(void)`

where

- *type* is the data type of the return argument
- *memclass* is a macro string. This string can be either `SWC_CODE` for runnables (external functions), or `SWC_CODE_LOCAL` for internal functions (*SWC* is the software component identifier).

Example

If you do *not* select the **Use AUTOSAR compiler abstraction macros** option, the software generates the following code:

```
/* Block signals (auto storage) */
BlockIO rtB;

/* Block states (auto storage) */
D_Work rtDWork;

/* Model step function */
```

```
void Runnable_Step(void)
```

However, if you select the **Use AUTOSAR compiler abstraction macros** check box, the software generates macros in the code:

```
/* Block signals (auto storage) */
VAR(BlockIO, SWC1_VAR) rtB;

/* Block states (auto storage) */
VAR(D_Work, SWC1_VAR) rtDWork;

/* Model step function */
FUNC(void, SWC1_CODE) Runnable_Step(void)
```

Root-Level Matrix I/O

The software supports matrix I/O at the root-level by generating code that implements matrices as one-dimensional arrays. However, this behavior is not the default. Before you build your model, on the **AUTOSAR Code Generation Options** pane of the Configuration Parameters dialog box, select **Support root-level matrix I/O using one-dimensional arrays**.

Export AUTOSAR Software Component

After configuring your AUTOSAR export options, generate code to export your AUTOSAR Software Component.

To generate code and XML files:

- For a single runnable from a top model, build the model (**Ctrl+B**).
- For multiple runnables from subsystems:
 - 1** Right-click the top-level subsystem.
 - 2** Select **C/C++ Code > Export Functions**. The Build Code for Subsystem dialog box opens.
 - 3** Click **Build**.

This command builds code for an AUTOSAR runnable for each subsystem. The build also creates an additional runnable to aggregate the initialization functions for each of the function-call subsystems.

The software component C code and the following XML files are exported to the build folder. The following table shows which XML files are generated based on the value of **Configure AUTOSAR Interface > XML Options > Exported XML file packaging**.

Exported XML File Packaging Value	File Name	Description
Modular	<i>modelName</i> _behavior.xml	Specifies the software component internal behavior
	<i>modelName</i> _implementation.xml	Specifies the software component implementation
	<i>modelName</i> _interface.xml	Specifies the software component interfaces, including extra interfaces
	<i>modelName</i> _component.xml	Specifies the software component type, including additional ports added to the Simulink model
	<i>modelName</i> _datatype.xml	Specifies the software component data types, including any modified or additional data types
Single file	<i>modelName</i> .xml	Contains all specifications

Note In addition to the AUTOSAR software component C code, Embedded Coder creates the following header files in the `stub` subfolder of the build folder:

- `Rte_Type.h`
- `Rte_SWC.h`, where *SWC* is the name of the software component
- `Compiler.h`

These files contain dummy implementations of AUTOSAR functions, which the software uses for SIL and PIL simulations. You must *not* use these files outside Simulink. Your AUTOSAR RTE generator should produce the equivalent files.

You can merge the software component information back into an AUTOSAR authoring tool. This software component information is partitioned into separate files to facilitate merging. The partitioning attempts to minimize the number of merges that you must do. You do not need to merge the data type file into the authoring tool because data types are usually defined early in the design process. You must, however, merge the internal behavior file because this information is part of the model implementation.

For examples of how to generate AUTOSAR-compliant code and export AUTOSAR Software Component description XML files from a Simulink model, see the following examples.

- AUTOSAR Code Generation
- AUTOSAR Code Generation for Multiple Runnable Entities

Configure AUTOSAR Options Programmatically

To control AUTOSAR options programmatically, use the AUTOSAR functions listed in the following class reference pages:

- `arxml.importer`
- `RTW.AutosarInterface`

Verify AUTOSAR Code with SIL and PIL

In this section...
“Overview” on page 17-89
“Use the SIL and PIL Simulation Modes” on page 17-89
“Use a SIL or PIL Block for AUTOSAR Verification” on page 17-90

Overview

You can carry out model-based verification of AUTOSAR software components using software-in-the-loop (SIL) and processor-in-the-loop (PIL) simulations. Use SIL for verification of generated source code on your host computer, and PIL for verification of object code on your production target.

Use the SIL and PIL Simulation Modes

You can run a top model or Model block that is configured for the AUTOSAR target (`autosar.tlc`) using the Software-in-the-Loop (SIL) and Processor-in-the-Loop (PIL) simulation modes.

For more information, see “Top-Model SIL or PIL Simulation” on page 31-15 and “Model Block SIL or PIL Simulation” on page 31-17.

AUTOSAR Top Model SIL and PIL Support

For a top model running in SIL or PIL simulation mode, the software does *not* support client-server operations.

Logging Invariant Output Signals. Through signal logging, you can configure your top model to log invariant output signals. However, the software will log these invariant signals as periodically sampled data.

AUTOSAR Model Block SIL and PIL Support

The software supports testing of AUTOSAR components that are modeled as model reference components. These model reference components are implemented as standard model reference Simulink Coder targets and do not contain special AUTOSAR behavior.

Use a SIL or PIL Block for AUTOSAR Verification

To verify source code, you create a SIL block, which wraps the generated code in an S-function. The AUTOSAR target automatically configures the generated S-function to route simulation data using AUTOSAR run-time environment (RTE) API calls.

To verify the behavior of production-intent object code, you create a PIL block. You must provide an implementation of the target connectivity API for this block.

To carry out a verification using a SIL or PIL block:

- 1** In the Configuration Parameters dialog box, select the **Code Generation** pane and clear **Generate code only**. If you select **Generate code only**, the software does not create a SIL or PIL block.
- 2** Select the **Code Generation > Verification** pane.
- 3** From the **Create block** drop-down list, select either SIL or PIL. Click **OK**.
- 4** To create your SIL or PIL block, generate code in the usual way. See “Export AUTOSAR Software Component” on page 17-85 and “Configure Multiple Runnables” on page 17-69.
- 5** Once the SIL or PIL block is built, replace the existing component in your model with the new block.
- 6** Simulate the model and check the output to verify that the code produces the same data as the original subsystem.

Note The software does not propagate non-zero output initialization inside an AUTOSAR model to the outputs (via the RTE) until the step function executes. When you run the generated code in a SIL simulation, you do not see the output initialization until the SIL wrapper executes the step function for the first time.

For more information about configuring and running simulations with SIL or PIL blocks, see “Use a SIL or PIL Block” on page 31-19.

AUTOSAR SIL and PIL Block Support

For a SIL or PIL block, the software does *not* support client-server operations.

Runnable with Stateflow Chart Using Absolute Time. Consider a runnable (function-call subsystem) in a model, which contains a Stateflow chart using absolute-time temporal logic. Replace the runnable with a SIL block and run a simulation with the model. If the SIL block is executed conditionally in the model, then the results of the SIL simulation differ from the results of the Normal mode simulation.

Runnables in Feedback Loops. If your model has function-call subsystems and you export a runnable that has context-dependent inputs (for example, feedback signals), then the results of a SIL/PIL simulation with the generated code may not match the results of the Normal mode simulation of your model. See “Exported Functions in Feedback Loops” on page 31-81.

Limitations and Tips

In this section...

“Cannot Import Internal Behavior” on page 17-92

“Cannot Copy Subsystem Blocks Without Losing Interface Information” on page 17-93

“Source of Initial Output Value for Function-Call Subsystem Output” on page 17-93

“Error If No Default Configuration” on page 17-93

“The Generate Code Only Check Box” on page 17-93

“Specify Sample Time Independent Server Operation Model” on page 17-93

“Invoke AUTOSAR Server Operation Block in Referenced Model” on page 17-94

“Cannot Save Importer Objects in MAT-Files” on page 17-94

“Use the Merge Block for Inter-Runnable Variables” on page 17-94

“Use Goto and From Blocks Within Wrapper Subsystems” on page 17-96

“Postfix in Generated File Names” on page 17-96

“AUTOSAR Compiler Abstraction Macros” on page 17-97

“Intrinsic Fixed-Point Types for Model Configured as Server” on page 17-98

“Server Operation Model with Tunable Parameters” on page 17-99

“Relative File Paths in Code Descriptors” on page 17-99

Cannot Import Internal Behavior

Internal behavior is not parsed. This means I/O information stored at the runnable level (for example, implicit or explicit) is not imported, and internal I/O settings default to implicit. You can subsequently configure these I/O ports with the `setIODataAccessMode` method or in the Configure AUTOSAR Interface dialog box.

Cannot Copy Subsystem Blocks Without Losing Interface Information

If you copy and paste a subsystem block to create a new block in either a new model or the same model, the software does not copy the AUTOSAR interface information stored with the original subsystem block to the new subsystem block.

Source of Initial Output Value for Function-Call Subsystem Output

Before exporting a runnable from a function-call subsystem with an output, you must set the Output block parameter `SourceOfInitialOutputValue` to `Dialog`. Otherwise, when you try to export the runnable, the software generates an error indicating this requirement. See the Output reference page.

Error If No Default Configuration

If you do not configure your model using the **Get Default Configuration** button or the `RTW.AutosarInterface.getDefaultConf` method, when you build the model the software produces an error message indicating this.

The Generate Code Only Check Box

If you do not select the **Generate code only** check box, the software produces an error message when you build the model. The message states that you can build an executable with the AUTOSAR target only if you:

- Configure the model to create a software-in-the-loop (SIL) or processor-in-the-loop (PIL) block
- Run the model in SIL or PIL simulation mode
- Provide a custom template makefile

Specify Sample Time Independent Server Operation Model

For a server operation model, MathWorks recommends that you set the **Periodic sample time constraint** on the **Solver** configuration parameters

dialog pane to Ensure sample time independent. With this parameter, you can specify the sample time of the client model that invokes the server model (through an Invoke AUTOSAR Server Operation block) independently of the server model. If you do not specify this parameter, you need to check that the client block calls the server block at the same sample time. Otherwise, the data returned from the server model may be invalid.

Invoke AUTOSAR Server Operation Block in Referenced Model

The software does not support the use of the Invoke AUTOSAR Server Operation block in a referenced model.

Cannot Save Importer Objects in MAT-Files

If you try to save an `arxml.importer` object in a MAT-file, you lose the information. If you reload the MAT-file, then the object is null (`handle = -1`), because of the Java® objects that compose the `arxml.importer` object.

Use the Merge Block for Inter-Runnable Variables

You can use the Merge block to merge inter-runnable variables. However, you must do the following:

- Connect the output signal of the Merge block to either one root outputport or one or more subsystems.
- If the output signal of the Merge block is connected to the inputs of one or more subsystems, assign the same signal name to the Merge block's output and inputs.

In addition, the signal from the function-call subsystem outputport that enters a Merge block must not be conditionally computed. Consider the following example.

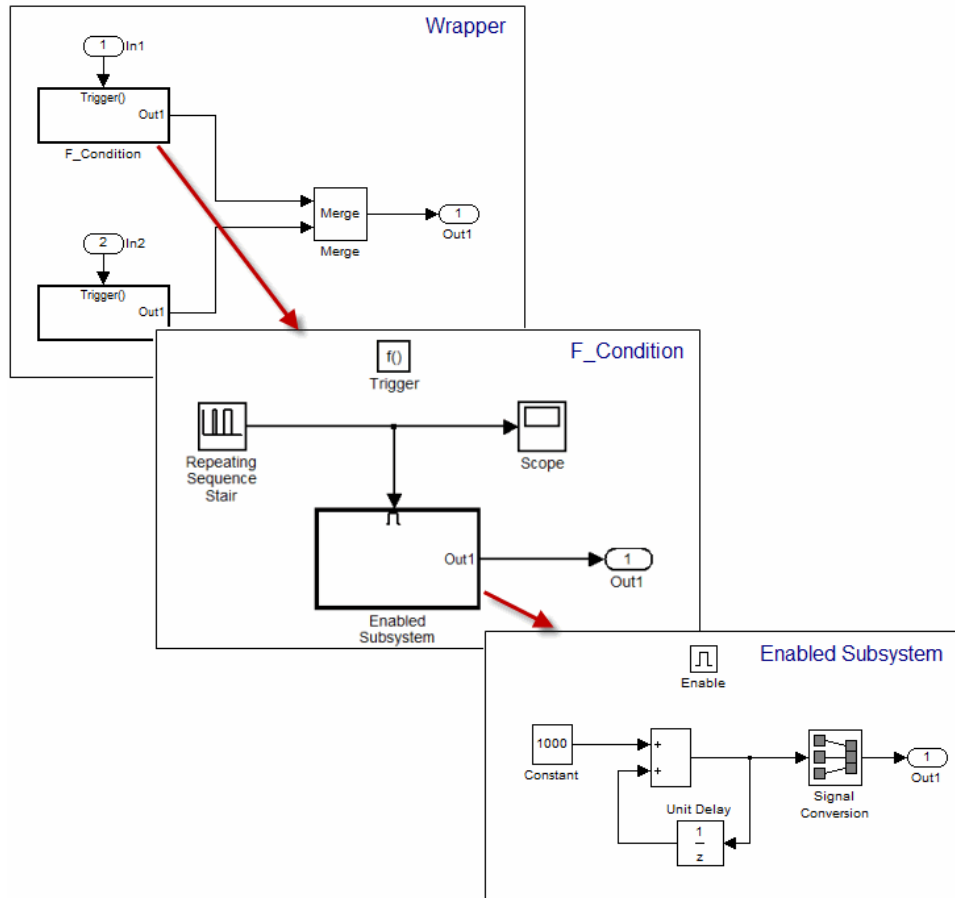

The output from the subsystem F_condition is the conditional output from Enabled Subsystem. When you try to validate or build the model, the software generates an error.

If you use an S-Function block instead of the Enabled Subsystem block, the software generates a *warning* when you validate or build the model.

Use Goto and From Blocks Within Wrapper Subsystems

If your wrapper subsystem contains Goto and From blocks, you can generate code and XML files for multiple runnables. However, you must:

- Set the scope of the Goto block tag to `local`.
- Label, unambiguously, signals entering and leaving Goto and From blocks that connect subsystems. If the signal into the Goto block and the signal out of the corresponding From block connect two subsystems (runnables), then these signal segments represent an inter-runnable variable. You must provide a label for at least one signal segment, for example, the signal into the Goto block. In addition, if there are labels for other segments of the same signal, you must check that these labels are the same.

Postfix in Generated File Names

When you use the Export Functions feature, the software creates a hidden intermediate model and generates code from the intermediate model. The software generates files with names that contain a postfix if:

- Your top model or a loaded model and the wrapper subsystem have identical names.
- Libraries used by your model have the same name as the wrapper subsystem. These libraries are also used by the intermediate model, and the software recognizes this when generating code for the wrapper subsystem.

For example, if you rename the model `rtwdemo_autosar_multirunnables` `ASWC` and build the wrapper subsystem `ASWC`, the software creates the following files:

```
Generated Files
[-] Model files
    ASWC0.c
    ASWC0.h
[+] Utility files (1)
[-] Interface files
    ASWC0_behavior.arxml
    ASWC0_component.arxml
    ASWC0_datatype.arxml
    ASWC0_implementation.arxml
    ASWC0_interface.arxml
[+] Other files (3)
```

The names of files generated from the wrapper subsystem ASWC have the postfix 0.

To avoid creating file names with postfixes, check that:

- The name of the wrapper subsystem is different from your top model or another loaded model.
- Libraries used by your model do not have the same name as the wrapper subsystem.

To identify loaded models and libraries that have the same name as the wrapper subsystem, you can use the command `find_system`. For information about:

- Removing models and libraries from memory, see the `close_system` reference page.
- Closing system windows, see the `bdclose` reference page.

AUTOSAR Compiler Abstraction Macros

The software does not generate AUTOSAR compiler abstraction macros for data or functions arising from the following:

- Model blocks
- Stateflow

- MATLAB Coder
- Shared utility functions
- Custom storage classes
- Local or temporary variables

Intrinsic Fixed-Point Types for Model Configured as Server

The software does not support operation prototype arguments with intrinsic fixed-point data types. For example, `ufix5` shown in the following figure.

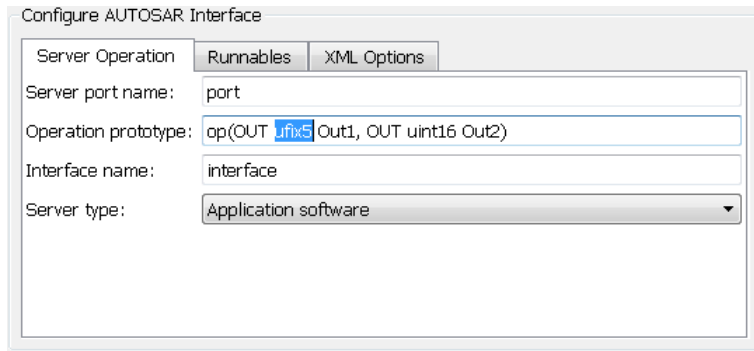

The software produces an error when you build the model.

To work around this limitation, before building the model, create a `Simulink.NumericType` base workspace object with the required property values. For example, to create a `Simulink.NumericType` object `ufix5`, enter the following in the Command Window:

```
>> ufix5 = Simulink.NumericType;
>> ufix5.DataTypeMode = 'Fixed-point: binary point scaling';
>> ufix5.Signedness = 'Signed'
>> ufix5.WordLength = 16
>> ufix5.FractionLength = 0
>> ufix5.IsAlias = 1;
>> ufix5.HeaderFile = 'Rte_Type.h'
```

For more information, see `Simulink.NumericType` in the Simulink documentation.

Server Operation Model with Tunable Parameters

The software does not provide AUTOSAR support for a model that is configured as a server operation and has tunable parameters with storage class set to `SimulinkGlobal (Auto)`.

Relative File Paths in Code Descriptors

When you build a Simulink model for an AUTOSAR target, the software generates a `CODE-DESCRIPTORS` element within the `SWC_IMPLEMENTATION` element. The `CODE-DESCRIPTORS` element contains `XFILE` elements that provide descriptions of the generated code.

For example, if you build the model `rtwdemo_autosar_counter`, the generated file `rtwdemo_autosar_counter_implementation.arxml` has the following `XFILE` element:

```
...
  <XFILE>
    <SHORT-NAME>rtwdemo_autosar_counter_c</SHORT-NAME>
    <CATEGORY>GeneratedFile</CATEGORY>
    <URL>rtwdemo_autosar_counter_autosar_rtw\rtwdemo_autosar_counter.c</URL>
    <TOOL>Embedded Coder</TOOL>
    <TOOL-VERSION>5.6</TOOL-VERSION>
  </XFILE>
...
```

However, the `URL` element does not specify an absolute path. The path is *relative* to the build folder. Therefore, before you use the AUTOSAR XML in a Run-Time Environment to generate code, you must place the XML in the parent folder.

Sample Workflows and Further Reading

AUTOSAR Examples

For detailed explanations of AUTOSAR workflows with Embedded Coder software, see the examples in the following table.

Example	How to ...
AUTOSAR Code Generation: <code>rtwdemo_autosar_legacy_script</code>	Generate AUTOSAR-compliant code and export AUTOSAR Software Component description XML files from a Simulink model.
Using an AUTOSAR Client-Server Interface <code>rtwdemo_autosar_clientserver_script</code>	Configure and generate AUTOSAR-compliant code and export AUTOSAR-compliant XML files for a Simulink model with an AUTOSAR client-server interface.
AUTOSAR Code Generation for Multiple Runnable Entities: <code>rtwdemo_autosar_multirunnables_script</code>	Configure and generate AUTOSAR-compliant code and export AUTOSAR Software Component description XML files for a Simulink model with multiple runnables.
Import and Export an AUTOSAR Software Component: <code>rtwdemo_autosar_roundtrip_script</code>	Use an AUTOSAR authoring tool with Simulink to develop AUTOSAR Software Components. Learn how to import software component interfaces into Simulink, modify and export them, and merge the completed software component back into an AUTOSAR authoring tool.
Using Data Stores to Access Per-Instance Memory: <code>rtwdemo_autosar_PIM_script</code>	Publish an AUTOSAR Software Component with per-instance memory.

Further Reading

For more information, see the AUTOSAR Web site:
<http://www.autosar.org/>.

Report Generation

- “HTML Code Generation Report Extensions” on page 18-2
- “Traceability in Code Generation Report” on page 18-4
- “Model Web View in Code Generation Report” on page 18-6
- “Analyze the Generated Code Interface” on page 18-11
- “Static Code Metrics” on page 18-25
- “Generate a Static Code Metrics Report for a Simulink Model” on page 18-28
- “Generate a Static Code Metrics Report for MATLAB Code” on page 18-32
- “Analyze Code Replacements in the Generated Code” on page 18-35
- “Generate HTML Report After Build Process” on page 18-37

HTML Code Generation Report Extensions

The Embedded Coder code generation report is an enhanced version of the HTML code generation report generated by the Simulink Coder build process. With the Embedded Coder software, you can configure your model to include the following sections in the report:

- The **Code Interface Report** section provides information about the generated code interface, including model entry point functions and input/output data. For more information, see “Analyze the Generated Code Interface” on page 18-11.
- The **Traceability Report** section allows you to account for **Eliminated / Virtual Blocks** that are untraceable versus the listed **Traceable Simulink Blocks / Stateflow Objects / MATLAB Scripts**, providing a complete mapping between model elements and code. For more information, see “Customize Traceability Reports” on page 28-10.
- The **Static Code Metrics Report** section provides statistics of the generated code. Metrics are estimated from static analysis of the generated code. For more information, see “Static Code Metrics” on page 18-25.
- The **Code Replacements Report** section allows you to account for code replacement library (CRL) functions that were used during code generation, providing a mapping between each replacement instance and the Simulink block that triggered the replacement. For more information, see “Analyze Code Replacements in the Generated Code” on page 18-35.
- The model Web view displays an interactive model diagram within the code generation report and supports traceability between the source code and the model. Therefore, you can share your model and generated code outside of the MATLAB environment. For more information, see “Generate HTML Code Generation Report with Model Web View” on page 18-7.

In the **Generated Files** section on the **Contents** pane, you can click the names of source code files generated from your model to view their contents in a MATLAB Web browser window. In the displayed source code:

- If you enable code-to-model traceability, hyperlinks within the displayed source code navigate to the blocks or subsystems from which the code was generated. For more information, see “Traceability in Code Generation

Report” on page 18-4 and “Trace Code to Model Objects Using Hyperlinks” on page 28-4.

- If you enable model-to-code traceability, you can navigate to the generated code for a block in the model. For more information, see “Trace Model Objects to Generated Code” on page 28-6.
- If you set the **Code coverage tool** parameter on the **Code Generation > Verification** pane, you can view the code coverage data and annotations. For more information, see “Code Coverage in SIL and PIL Simulations” on page 32-2.

Traceability in Code Generation Report

This example shows how to create an HTML code generation report which includes links to trace between the source code and the Simulink model window.

- 1 With your ERT-based model open, open the Configuration Parameters dialog box or Model Explorer and navigate to the **Code Generation > Report** pane.
- 2 Select **Create code generation report** if it is not already selected. By default, **Open report automatically** and **Code-to-model** are selected. **Model-to-code** is not selected.
- 3 Select the **Model-to-code** parameter.
- 4 If your model contains referenced models and you want to enable traceability for the referenced model's code generation report, repeat steps 2–3 for each referenced model.
- 5 Generate code for your model by clicking **Build** on the **Code Generation** pane of the Configuration Parameters dialog box. The build process opens the code generation report in a MATLAB Web browser.
- 6 In the left navigation pane, select a source code file. In the source code in the right pane, there are hyperlinks to blocks in the model.
- 7 Click a hyperlink in the code. The model diagram window displays and highlights the corresponding block in the model.
- 8 To highlight the generated code for a block in your Simulink model, right-click the block and select **C/C++ Code > Navigate to C/C++ Code**. This selection highlights the generated code for the block in the HTML code generation report.
- 9 If you have a referenced model in your model, in the left navigation pane, below **Reference Models**, click the link to a referenced model. The code generation report for the referenced model is now displayed in the window.
- 10 In the left navigation pane, click the **Back** button to go back to the previous code generation report.

Note For large models (containing over 1000 blocks), you might find that HTML report generation takes longer than you want. In this case, consider clearing the **Code-to-model** and **Model-to-code** check boxes.

For more information about navigating between the generated code and the model diagram, see:

- “Trace Model Objects to Generated Code” on page 28-6
- “Trace Code to Model Objects Using Hyperlinks” on page 28-4
- “Traceability Limitations” on page 28-13

Model Web View in Code Generation Report

In this section...

“About Model Web View” on page 18-6

“Generate HTML Code Generation Report with Model Web View” on page 18-7

“Model Web View Limitations” on page 18-9

About Model Web View

To review and analyze the generated code, it is helpful to navigate between the code and model. You can include a Web view of the model within the HTML code generation report. You can then share your model and generated code outside of the MATLAB environment. When you generate the report, the Web view includes the block diagram attributes displayed in the Simulink Editor, such as, block sorted execution order, signal properties, and port data types.

A Simulink Report Generator license is required to include a Web view of the model in the code generation report.

Browser Requirements for Web View

Web view requires a Web browser that supports Scalable Vector Graphics (SVG). Web view uses SVG to render and navigate models.

You can use the following Web browsers:

- Mozilla Firefox Version 1.5 or later, which has native support for SVG. To download the Firefox browser, go to www.mozilla.com/.
- The Microsoft Internet Explorer® Web browser with the Adobe® SVG Viewer plug-in. To download the Adobe SVG Viewer plug-in, go to www.adobe.com/svg/.
- Apple Safari Web browser

Generate HTML Code Generation Report with Model Web View

This example shows how to create an HTML code generation report which includes a Web view of the model diagram.

- 1 Open the `rtwdemo_md1reftop` model.
- 2 Open the Configuration Parameters dialog box or Model Explorer and navigate to the **Code Generation** pane.
- 3 Specify `ert.tlc` for the **System target file** parameter.
- 4 Open the **Code Generation > Report** pane.
- 5 Select the following parameters:
 - **Create code generation report**
 - **Open report automatically**
 - **Code-to-model**
 - **Model-to-code**
 - **Generate model Web view**

Note These settings specify only the top model, not referenced models.

- 6 Open the Configuration Parameters for the referenced model, `rtwdemo_md1refbot` and perform steps 3–5.
- 7 Save the models, `rtwdemo_md1reftop` and `rtwdemo_md1refbot`.
- 8 From the top model diagram, press **Ctrl+B**. After building the model and generating code, the code generation report for the top model opens in a MATLAB Web browser.
- 9 In the left navigation pane, select a source code file. The corresponding source code is displayed in the right pane and includes hyperlinks.

The screenshot shows the 'Code Generation Report' window. On the left is a navigation pane with sections for 'Contents' (Summary, Subsystem Report, Code Interface Report, Traceability Report, Static Code Metrics Report, Code Replacements Report) and 'Generated Files' (Main file: ert_main.c; Model files: rtwdemo_mdrefbot.c, rtwdemo_mdrefbot.h, rtwdemo_mdrefbot_private.h, rtwdemo_mdrefbot_types.h; Shared Utility files (1)). Below this is a 'Referenced Models' section with a link to rtwdemo_mdrefbot.

The main area displays C source code for the function `rtwdemo_mdrefbot_step`. The code includes local block I/O variables and a discrete pulse generator block. A comment indicates the pulse generator is '`<Root>/Pulse (Ts=0.1)`'. The code logic checks the clock tick counter and updates the output and counter variables.

Below the code is a Simulink model diagram titled 'rtwdemo_mdrefbot'. The diagram shows three instances of the 'rtwdemo_mdrefbot' block, each with its own 'Counter' (CounterA, CounterB, CounterC) and 'Scope' (ScopeA, ScopeB, ScopeC) block. The blocks are interconnected with 'Pulse' blocks (Ts=0.1, Ts=0.5, Ts=1.0). The 'rtwdemo_mdrefbot' block in the diagram is highlighted in pink, and its corresponding code in the source pane is highlighted in yellow.

At the bottom of the window, there are two blue buttons: 'Generate Code Using Simulink Coder (rtwdemo_mdrefbot)' and 'Generate Code Using Embedded Coder (rtwdemo_mdrefbot)'. There are also 'OK' and 'Help' buttons at the very bottom right.

- 10 Click a link in the code. The model Web view displays and highlights the corresponding block in the model.
- 11 To highlight the generated code for a referenced model block in your model, click CounterB. The corresponding code is highlighted in the source code pane.

Note You cannot open the referenced model diagram in the Web view by double-clicking the referenced model block in the top model.

- 12** To open the code generation report for a referenced model, in the left navigation pane, below **Referenced Models**, click the link, `rtwdemo_md1refbot`. The source files for the referenced model are displayed along with the Web view of the referenced model.
- 13** To go back to the code generation report for the top model, at the top of the left navigation pane, click the **Back** button until the top model's report is displayed.

For more information about exploring a model in a Web view, see “Navigate Web Views” in the Simulink Report Generator documentation.

For more information about navigating between the generated code and the model diagram, see :

- “Trace Model Objects to Generated Code” on page 28-6
- “Trace Code to Model Objects Using Hyperlinks” on page 28-4

Model Web View Limitations

The HTML code generation report includes the following limitations when using the model Web view:

- Code is not generated for virtual blocks. In the model Web view of the code generation report, when tracing between the model and the code, when you click a virtual block, it is highlighted yellow.
- In the model Web view, you cannot open a referenced model diagram by double-clicking the referenced model block in the top model. Instead, open the code generation report for the referenced model by clicking a link under **Referenced Models** in the left navigation pane.
- Stateflow truth tables, events, and links to library charts are not supported in the model Web view.
- Searching in the code generation report does not find or highlight text in the model Web view.

- If you navigate from the actual model diagram (not the model Web view in the report), to the source code in the HTML code generation report, the model Web view is disabled and not visible. To enable the model Web view, open the report again, see “Open Code Generation Report”.
- For a subsystem build, the traceability hyperlinks of the root level inport and outport blocks are disabled.
- “Traceability Limitations” on page 28-13 that apply to tracing between the code and the actual model diagram.

Analyze the Generated Code Interface

In this section...

- “Code Interface Report Overview” on page 18-11
- “Generating a Code Interface Report” on page 18-12
- “Navigating Code Interface Report Subsections” on page 18-15
- “Interpreting the Entry Point Functions Subsection” on page 18-16
- “Interpreting the Inports and Outports Subsections” on page 18-19
- “Interpreting the Interface Parameters Subsection” on page 18-20
- “Interpreting the Data Stores Subsection” on page 18-22
- “Code Interface Report Limitations” on page 18-23

Code Interface Report Overview

When you select the **Create code generation report** option for an ERT-based model, a **Code Interface Report** section is automatically included in the generated HTML report. The **Code Interface Report** section provides documentation of the generated code interface for consumers of the generated code, including model entry point functions and interface data, for consumers of the generated code. The information in the report can help facilitate code review and code integration.

The code interface report includes the following subsections:

- **Entry Point Functions** — interface information about each model entry point function, including `model_initialize`, `model_step`, and (if applicable) `model_terminate`.
- **Inports and Outports** — interface information about each model inport and outport.
- **Interface Parameters** — interface information about tunable parameters that are associated with the model.
- **Data Stores** — interface information about global data stores and data stores with non-auto storage that are associated with the model.

For limitations that apply to code interface reports, see “Code Interface Report Limitations” on page 18-23.

For illustration purposes, this section uses the following models:

- `rtwdemo_basicsc` (with the **ExportedGlobal Storage Class** button selected in the model window) for examples of report subsections
- `rtwdemo_mrmtbb` for examples of timing information
- `rtwdemo_fcnprotoctrl` for examples of function argument and return value information

Generating a Code Interface Report

To generate a code interface report for your model:

- 1** Open your model, go to the **Code Generation** pane of the Configuration Parameters dialog box, and select `ert.tlc` or an ERT-based **System target file**, if one is not already selected.
- 2** Go to the **Code Generation > Report** pane of the Configuration Parameters dialog box and select the option **Create code generation report**, if it is not already selected. The `rtwdemo_basicsc`, `rtwdemo_mrmtbb`, and `rtwdemo_fcnprotoctrl` models used in this section select multiple **Report** pane options by default. But selecting only **Create code generation report**, generates a **Code Interface Report** section in the HTML report.

Alternatively, you can programmatically select the option by issuing the following MATLAB command:

```
set_param(bdroot, 'GenerateReport', 'on')
```

If the **Report** pane option **Code-to-model** is selected, the generated report contains hyperlinks to the model. Leave this value selected unless you plan to use the report outside the MATLAB environment.

- 3** Build the model. If you selected the **Report** pane option **Open report automatically**, the code generation report opens automatically after the build process is complete. (Otherwise, you can open it manually from within the model build folder.)

- 4 To display the code interface report for your model, go to the **Contents** pane of the HTML report and click the **Code Interface Report** link. For example, here is the generated code interface report for the model `rtwdemo_basicsc` (with the **ExportedGlobal Storage Class** button selected in the model window).

Code Interface Report for rtwdemo_basicsc

Table of Contents

- [Entry Point Functions](#)
- [Inports](#)
- [Outports](#)
- [Interface Parameters](#)
- [Data Stores](#)

Entry Point Functions

Function: [rtwdemo_basicsc_initialize](#)

Prototype	void rtwdemo_basicsc_initialize(void)
Description	Initialization entry point of generated code
Timing	Called once
Arguments	None
Return value	None
Header file	rtwdemo_basicsc.h

Function: [rtwdemo_basicsc_step](#)

Prototype	void rtwdemo_basicsc_step(void)
Description	Output entry point of generated code
Timing	Called periodically, every 1 second
Arguments	None
Return value	None
Header file	rtwdemo_basicsc.h

Inports

[-]

Block Name	Code Identifier	Data Type	Dimension
<Root>/In1	rtU.input1	real32_T	1
<Root>/In2	rtU.input2	real32_T	1
<Root>/In3	rtU.input3	real32_T	1
<Root>/In4	rtU.input4	real32_T	1

Outports

Block Name	Code Identifier	Data Type	Dimension
<Root>/Out1	rtY.Out1	real32_T	1

Interface Parameters

No interface/tunable parameters in model.

Data Stores

No data stores in the model; note that this report lists only data stores with non-auto storage class and global data stores

For help navigating the content of the code interface report subsections, see “Navigating Code Interface Report Subsections” on page 18-15. For help interpreting the content of the code interface report subsections, see the sections beginning with “Interpreting the Entry Point Functions Subsection” on page 18-16.

Navigating Code Interface Report Subsections

To help you navigate code interface descriptions, the code interface report provides collapse/expand tokens and hyperlinks, as follows:

- For a large subsection, the report provides [-] and [+] symbols that allow you to collapse or expand that section. In the example in the previous section, the symbols are provided for the **Inports** and **Interface Parameters** sections.
- Several forms of hyperlink navigation are provided in the code interface report. For example:
 - The **Table of Contents** located at the top of the code interface report provides links to each subsection.
 - You can click each function name to go to its definition in *model.c*.
 - You can click each function’s header file name to go to the header file source listing.
 - If you selected the **Report** pane option **Code-to-model** for your model, to go to the corresponding location in the model display, you can click hyperlinks for any of the following:
 - Function argument
 - Function return value
 - Inport
 - Outport
 - Interface parameter (if the parameter source is a block)
 - Data store (if the data store source is a Data Store Memory block)

For backward and forward navigation within the HTML code generation report, use the **Back** and **Forward** buttons above the **Contents** section in the upper-left corner of the report.

Interpreting the Entry Point Functions Subsection

The **Entry Point Functions** subsection of the code interface report provides the following interface information about each model entry point function, including `model_initialize`, `model_step`, and (if applicable) `model_terminate`.

Field	Description
Function:	Lists the function name. You can click the function name to go to its definition in <code>model.c</code> .
Prototype	Displays the function prototype, including the function return value, name, and arguments.
Description	Provides a text description of the function's purpose in the application.
Timing	Describes the timing characteristics of the function, such as how many times the function is called, or if it is called periodically, and at what time interval. For a multirate timing example, see the following <code>rtwdemo_mrmtbb</code> report excerpt.
Arguments	If the function has arguments, displays the number, name, data type, and Simulink description for each argument. If you selected the Report pane option Code-to-model for your model, you can click the hyperlink in the description to go to the block corresponding to the argument in the model display. For argument examples, see the <code>rtwdemo_fcnpctctrl</code> report excerpt below.

Field	Description
Return value	If the function has a return value, this field displays the return value data type and Simulink description. If you selected the Report pane option Code-to-model for your model, you can click the hyperlink in the description to go to the block corresponding to the return value in the model display. For a return value example, see the following <code>rtwdemo_fcncnprotoctrl</code> report excerpt.
Header file	Lists the name of the header file for the function. You can click the header file name to go to the header file source listing.

For example, here is the **Entry Point Functions** subsection for the model `rtwdemo_basicsc`.

Entry Point Functions

Function: [rtwdemo_basicsc_initialize](#)

Prototype	void rtwdemo_basicsc_initialize(void)
Description	Initialization entry point of generated code
Timing	Called once
Arguments	None
Return value	None
Header file	rtwdemo_basicsc.h

Function: [rtwdemo_basicsc_step](#)

Prototype	void rtwdemo_basicsc_step(void)
Description	Output entry point of generated code
Timing	Called periodically, every 1 second
Arguments	None
Return value	None
Header file	rtwdemo_basicsc.h

To illustrate how timing information might be listed for a multirate model, here are the **Entry Point Functions** and **Inports** subsections for the model `rtwdemo_mrmtbb`. This multirate, discrete-time, multitasking model contains Inport blocks 1 and 2, which specify 1-second and 2-second sample times, respectively. The sample times are constrained to the specified times

by the **Periodic sample time constraint** option on the **Solver** pane of the Configuration Parameters dialog box.

Entry Point Functions

Function: [rtwdemo_mrmtbb_initialize](#)

Prototype	void rtwdemo_mrmtbb_initialize(void)
Description	Initialization entry point of generated code
Timing	Called once
Arguments	None
Return value	None
Header file	rtwdemo_mrmtbb.h

Function: [rtwdemo_mrmtbb_step0](#)

Prototype	void rtwdemo_mrmtbb_step0(void)
Description	Output entry point of generated code
Timing	Called periodically, every 1 second
Arguments	None
Return value	None
Header file	rtwdemo_mrmtbb.h

Function: [rtwdemo_mrmtbb_step1](#)

Prototype	void rtwdemo_mrmtbb_step1(void)
Description	Output entry point of generated code
Timing	Called periodically, every 2 seconds
Arguments	None
Return value	None
Header file	rtwdemo_mrmtbb.h

To illustrate how function arguments and return values are displayed in the report, here is the **Entry Point Functions** description of the model step function for the model `rtwdemo_fcnpctctrl`.

Function: [rtwdemo_fcncnprotctrl_step_custom](#)

Prototype	boolean_T rtwdemo_fcncnprotctrl_step_custom (const real_T argIn1, const BusObject *const argIn2, BusObject *argOut2, const BusObject *const argIn3, uint8_T *argIn4)		
Description	Output entry point of generated code		
Timing	Called periodically, every 0.2 seconds		
Arguments	[-]		
	#	Name	Data Type
	1	argIn1	const real_T
	2	argIn2	const BusObject *const
	3	argOut2	BusObject *
	4	argIn3	const BusObject *const
	5	argIn4	uint8_T *
			Description
			<Root>/In1
			<Root>/In2
			<Root>/Out2
			<Root>/In3
			<Root>/In4
Return value	Data Type	Description	
	boolean_T	<Root>/Out1	
Header file	rtwdemo_fcncnprotctrl.h		

Interpreting the Inports and Outports Subsections

The **Inports** and **Outports** subsections of the code interface report provide the following interface information about each inport and output in the model.

Field	Description
Block Name	Displays the Simulink block name of the inport or output. If you selected the Report pane option Code-to-model for your model, you can click on each inport or output Block Name value to go to its location in the model display.
Code Identifier	Lists the identifier associated with the inport or output data in the generated code, as follows: <ul style="list-style-type: none"> • If the data is defined in the generated code, the field displays the identifier string. • If the data is declared but not defined in the generated code — for example, if the data is resolved with an imported storage class — the field displays the identifier string prefixed with the label 'Imported data:'.

Field	Description
	<ul style="list-style-type: none"> If the data is neither defined nor declared in the generated code — for example, if the option Generate reusable code is selected for the model — the field displays the string 'Defined externally'.
Data Type	Lists the data type of the inport or outport.
Dimension	Lists the dimensions of the inport or outport (for example, 1 or [4, 5]).

For example, here are the **Inports** and **Outports** subsections for the model `rtwdemo_basicsc`.

Inports

[-]

Block Name	Code Identifier	Data Type	Dimension
<Root>/In1	input1	real32_T	1
<Root>/In2	input2	real32_T	1
<Root>/In3	input3	real32_T	1
<Root>/In4	input4	real32_T	1

Outports

Block Name	Code Identifier	Data Type	Dimension
<Root>/Out1	output	real32_T	1

Interpreting the Interface Parameters Subsection

The **Interface Parameters** subsection of the code interface report provides the following interface information about tunable parameters that are associated with the model.

Field	Description
Parameter Source	<p>Lists the source of the parameter value, as follows:</p> <ul style="list-style-type: none"> • If the source of the parameter value is a block, the field displays the block name, such as <Root>/Gain2 or <S1>/Lookup1. If you selected the Report pane option Code-to-model for your model, you can click the Parameter Source value to go to the parameter's location in the model display. • If the source of the parameter value is a workspace variable, the field displays the name of the workspace variable prefixed with the label 'Workspace variable:'. For example, <code>Workspace variable: K2</code>.
Code Identifier	<p>Lists the identifier associated with the tunable parameter data in the generated code, as follows:</p> <ul style="list-style-type: none"> • If the data is defined in the generated code, the field displays the identifier string. • If the data is declared but not defined in the generated code — for example, if the data is resolved with an imported storage class — the field displays the identifier string prefixed with the label 'Imported data:'. • If the data is neither defined nor declared in the generated code — for example, if the option Generate reusable code is selected for the model — the field displays the string 'Defined externally'.
Data Type	Lists the data type of the tunable parameter.
Dimension	Lists the dimensions of the tunable parameter (for example, 1 or [4, 5, 6]).

For example, here is the **Interface Parameters** subsection for the model `rtwdemo_basicsc` (with the **ExportedGlobal Storage Class** button selected in the model window).

Interface Parameters

[-]

Parameter Source	Code Identifier	Data Type	Dimension
Workspace variable: K2	K2	real_T	1
Workspace variable: LOWER	LOWER	real32_T	1
Workspace variable: T1Break	T1Break	real32_T	[1 11]
Workspace variable: T1Data	T1Data	real32_T	[1 11]
Workspace variable: T2Break	T2Break	real32_T	[1 3]
Workspace variable: T2Data	T2Data	real32_T	[3 3]
Workspace variable: UPPER	UPPER	real32_T	1
Workspace variable: K1	K1	int8_T	1

Interpreting the Data Stores Subsection

The **Data Stores** subsection of the code interface report provides the following interface information about global data stores and data stores with non-auto storage that are associated with the model.

Field	Description
Data Store Source	<p>Lists the source of the data store memory, as follows:</p> <ul style="list-style-type: none"> • If the data store is defined using a Data Store Memory block, the field displays the block name, such as <Root>/DS1. If you selected the Report pane option Code-to-model for your model, you can click on the Data Store Source value to go to the data store's location in the model display. • If the data store is defined using a Simulink.Signal object, the field displays the name of the Simulink.Signal object prefixed with the label 'Global:'.
Code Identifier	<p>Lists the identifier associated with the data store data in the generated code, as follows:</p> <ul style="list-style-type: none"> • If the data is defined in the generated code, the field displays the identifier string.

Field	Description
	<ul style="list-style-type: none"> • If the data is declared but not defined in the generated code — for example, if the data is resolved with an imported storage class — the field displays the identifier string prefixed with the label 'Imported data:'. • If the data is neither defined nor declared in the generated code — for example, if the option Generate reusable code is selected for the model — the field displays the string 'Defined externally'.
Data Type	Lists the data type of the data store.
Dimension	Lists the dimensions of the data store (for example, 1 or [1, 2]).

For example, here is the **Data Stores** subsection for the model `rtwdemo_basicsc` (with the **ExportedGlobal Storage Class** button selected in the model window).

Data Stores

Data Store Source	Code Identifier	Data Type	Dimension
<Root>/Data Store Memory	mode	boolean_T	1

Code Interface Report Limitations

The following limitations apply to the code interface section of the HTML code generation reports.

- The code interface report does not support the GRT interface with an ERT target or the **C++ (Encapsulated)** language option. For these configurations, the code interface report is not generated and does not appear in the HTML code generation report **Contents** pane.
- The code interface report supports data resolved with most custom storage classes (CSCs), except when the CSC properties are set in any of the following ways:

- The CSC property **Type** is set to FlatStructure. For example, the BitField and Struct CSCs in the Simulink package have **Type** set to FlatStructure.
- The CSC property **Type** is set to Other. For example, the GetSet CSC in the Simulink package has **Type** set to Other.
- The CSC property **Data access** is set to Pointer, indicating that imported symbols are declared as pointer variables rather than simple variables. This property is accessible only when the CSC property **Data scope** is set to Imported or Instance-specific.

In these cases, the report displays empty **Data Type** and **Dimension** fields.

- For outports, the code interface report cannot describe the associated memory (data type and dimensions) if the memory is optimized. In these cases, the report displays empty **Data Type** and **Dimension** fields.
- The code interface report does not support data type replacement using the **Code Generation > Data Type Replacement** pane of the Configuration Parameters dialog box. The data types listed in the report will link to built-in data types rather than their specified replacement data types.

Static Code Metrics

In this section...
“About Static Code Metrics” on page 18-25
“Static Code Metrics Analysis” on page 18-26

About Static Code Metrics

The code generator performs static analysis of the generated C code and provides these metrics in the **Static Code Metrics Report** section of the HTML Code Generation Report.

You can use the information in the report to:

- Find the number of files and lines of code in each file.
- Estimate the number of lines of code and stack usage per function.
- Compare the difference in terms of how many files, functions, variables, and lines of code are generated every time you change the model or MATLAB algorithm.
- Determine a target platform and allocation of RAM to the stack, based on the size of global variables plus the estimated stack size.
- Determine possible performance slow points, such as the largest global variables or the most costly call path in terms of stack usage.
- View the cyclomatic complexity of a function, which counts the number of linearly independent paths through a function.
- View the function call tree. Determine the longest call path to estimate the worst case execution timing.
- View how target functions, provided by the selected code replacement library, are used in the generated code.

For examples, see

- “Generate a Static Code Metrics Report for a Simulink Model” on page 18-28
- “Generate a Static Code Metrics Report for MATLAB Code” on page 18-32

Static Code Metrics Analysis

Static analysis of the generated code is performed only on the source code without executing the program. The results of the static code metrics analysis are included in the **Static Code Metrics** section of the HTML Code Generation Report. The static code metrics report does not support the C++ target language. The report is not available if you generate a MEX function from MATLAB code.

Static analysis of the generated source code files:

- Uses the specified C data types. For Simulink models, you specify these data types in the **Hardware Implementation > Embedded hardware** pane of the Configuration Parameters dialog box. For code generation from MATLAB code, you specify them in the **Hardware** tab of the MATLAB Coder Project Settings dialog box or using a code generation configuration object. Actual object code metrics might differ due to target-specific compiler and platform settings.
- Includes custom code only if you specify it. For Simulink models, you specify custom code on the **Code Generation > Custom Code** pane in the model configuration. For code generation from MATLAB code, you specify it on the **Custom Code** tab of the MATLAB Coder Project Settings dialog box or using a code generation configuration object. An error report is generated if the generated code includes platform-specific files not contained in the standard C run-time library.
- For Simulink models, includes the generated code from referenced models.
- Uses 1-byte alignment for all members of a structure for estimating global and local data structure sizes. The size of a structure is calculated by summing the sizes of all of its fields. This estimation represents the smallest possible size for a structure.
- Calculates the self stack size of a function as the size of local data within a function, excluding input arguments. The accumulated stack size of a function is the self stack size plus the maximum of the accumulated stack sizes of its called functions. For example, if the accumulated stacks sizes for the called functions are represented as `accum_size1...accum_sizeN`, then the accumulated stack size for a function is

```
accumulated_stack_size = self_stack_size + max(accum_size1,...,accum_sizeN)
```

- When estimating the stack size of a function, static analysis stops at the first instance of a recursive call. The **Function Information** table indicates when recursion occurs in a function call path. Code generation generates only recursive code for Stateflow event broadcasting and for graphical functions if it is written as a recursive function.
- Calculates the cyclomatic complexity of a function as the number of decisions plus one:

$$CC = \text{Number of decisions} + 1$$

The following constructs add a decision:

- If statement
- Else-If statement
- Switch statement (1 decision for each case branch)
- Loop statements: While, For, Do-while

Note Boolean operators in the above constructs do not add extra decisions.

- Does not include `ert_main.c`, because you have the option to provide your own `main.c`.

Generate a Static Code Metrics Report for a Simulink Model

The **Static Code Metrics Report** is a section included in the HTML Code Generation Report. For more information on the static analysis of the generated code, see “Static Code Metrics Analysis” on page 18-26.

- 1 Before generating the HTML Code Generation Report, open the Configuration Parameters dialog box for your model. On the **Code Generation > Report** pane, select the “Static code metrics” checkbox.

If your model includes referenced models, select the **Static code metrics** checkbox in each referenced model’s configuration set. Otherwise, you cannot view a separate static code metrics report for a referenced model.

- 2 Press **Ctrl+B** to build your model and generate the HTML code generation report. For more information, see “Traceability in Code Generation Report” on page 18-4.
- 3 If the HTML Code Generation Report is not already open, open the report. On the left navigation pane, in the **Contents** section, select **Static Code Metrics Report**.

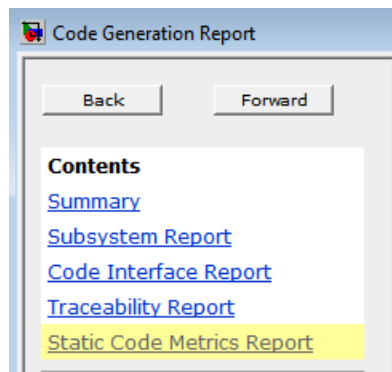

- 4 Hover your cursor over column titles and some column values to see a description of the corresponding data.

[-] File details

File Name	Lines of Code	Lines	Generated On
fuel_rate	595	1,042	06/25/2012 11:22 AM
fuel_rate	252	342	06/25/2012 11:22 AM
fuel_rate	107	268	06/25/2012 11:22 AM
rtwtypes.h	75	153	06/25/2012 11:22 AM

- 5 To see the generated files and how many lines of code are generated per file, look at the **File Information** section.

1. File Information [\[hide\]](#)

[-] Summary (excludes ert_main.c)

Number of .c files : 2
 Number of .h files : 2
 Lines of code : 1,029
 Lines : 1,805

[-] File details

File Name	Lines of Code	Lines	Generated On
fuel_rate_control.c	595	1,042	06/25/2012 11:22 AM
fuel_rate_control_data.c	252	342	06/25/2012 11:22 AM
fuel_rate_control.h	107	268	06/25/2012 11:22 AM
rtwtypes.h	75	153	06/25/2012 11:22 AM

- 6 If your model includes referenced models, the File information section includes a **Referenced Model** column. In this column, click the referenced model name to open its static code metrics report. If the static code metrics report is not available for a referenced model, specify the **Static code metrics** parameter in the referenced model's configuration set and rebuild your model.
- 7 To view the global variables in the generated code and their size, see the **Global Variables** section.

2. Global Variables [\[hide\]](#)

Global variables defined in the generated code.

Global Variable	Size (bytes)
rtDWork	83
rtU	16
rtM	4
rtY	4
Total	107

- 8 To navigate from the report to the source code, click a global variable or function name. These names are hyperlinks to their definitions.
- 9 To view the function call tree of the generated code, in the **Function Information** section, click **Call Tree** at the top of the table.

3. Function Information [\[hide\]](#)

View function metrics in a call tree format or table format. Accumulated stack numbers include the estimated stack size of the function plus the maximum of the accumulated stack size of the subroutines that the function calls.

View: Call Tree | [Table](#)

Function Name	Accumulated Stack Size (bytes)	Self Stack Size (bytes)	Lines of Code	Lines	Complexity
[-] fuel_rate_control_step	60	20	264	515	47
look2_iflf_linlca	40	40	68	111	14
[-] Fail	4	4	67	102	18
Fueling_Mode	0	0	132	209	25
Fueling_Mode	0	0	132	209	25
fuel_rate_control_initialize	0	0	9	24	1

ert_main.c is not included in the code metrics analysis, therefore it is not shown in the call tree format. The **Complexity** column includes the cyclomatic complexity of each function.

- 10 To view the functions in a table format, click **Table**.

3. Function Information [\[hide\]](#)

View function metrics in a call tree format or table format. Accumulated stack numbers include the estimated stack size of the function plus the maximum of the accumulated stack size of the subroutines that the function calls.

View: [Call Tree](#) | [Table](#)

Function Name	Called By (number of call sites)	Accumulated Stack Size (bytes)	Self Stack Size (bytes)	Lines of Code	Lines	Complexity
Fail	fuel_rate_control_step (9)	4	4	67	102	18
Fueling_Mode	Fail (2) fuel_rate_control_step	0	0	132	209	25
fuel_rate_control_initialize		0	0	9	24	1
fuel_rate_control_step		24	20	264	515	47
look2_iff_linlca	fuel_rate_control_step (5)	40	40	68	111	14

The second column, **Called By**, lists functions that call the function listed in the first column, using the following criteria:

- If a function is called by multiple functions, all functions are listed.
- If a function has no called function, this column is empty.

For example, `Fueling_Mode` is called by `Fail` and `fuel_rate_control_step`. The number of call sites is included in parentheses. `Fail` calls `Fueling_Mode` twice.

Generate a Static Code Metrics Report for MATLAB Code

In a MATLAB Coder Project

This example shows how to generate a static code metrics report for a static C library generated from MATLAB code in a MATLAB Coder project.

By default, when you generate standalone C code with MATLAB Coder, the code generation report now includes a static code metrics report. The static code metrics report is not available for generated MEX functions.

- 1 In a local, writable folder, create a MATLAB file, `moving_average.m`, that contains:

```
function [avg,z] = moving_average(x,z)
%#codegen
    if nargin < 2,
        z = zeros(10,1);
    end
    z(2:end) = z(1:end-1); % Update buffer
    z(1) = x;             % Add new value
    avg = mean(z);        % Compute moving average
end
```

- 2 In the same folder, set up a MATLAB Coder project.

- a At the MATLAB command line, enter:

```
coder -new moving_average.prj
```

By default, the project opens in the MATLAB workspace on the right side.

- b On the project **Overview** tab, click the `Add files` link. Browse to the file `moving_average.m`. Click **OK** to add the file to the project.

The file is displayed on the **Overview** tab. Both inputs are undefined.

- c Define the type of input `u`.
 - i On the **Overview** tab, click the field to the right of the input parameter `x` and, from the list of input options, select `double`.

- ii From the list of size options, select 1 x 1 to specify that the input is a scalar.
- 3 Repeat the previous step for input z.
- 4 In the MATLAB Coder project, click the **Build** tab.
- 5 On this tab, set the **Output type** to C/C++ Static library.
The default output file name is moving_average.
- 6 On this tab, click **More settings** to open the Project Settings dialog box.
- 7 In the Project Settings dialog box, select the Debugging tab and verify that **Static code metrics** is selected.
- 8 Click the **Build** button to generate a library.

MATLAB Coder builds the project and generates a C static library and supporting files in the default folder, codegen/lib/moving_average and provides a link to the code generation report.
- 9 Open the code generation report and click **Static Code Metrics Report** to open the report.
- 10 To see the generated files and how many lines of code are generated per file, look at the **File Information** section.
- 11 To view the global variables in the generated code and their size, see the **Global Variables** section.

To navigate from the report to the source code, click a global variable name. The names are hyperlinks to their definitions.

- 12 To view the function call tree of the generated code, in the **Function Information** section, click **Call Tree** at the top of the table.

To navigate from the report to the function code, click a function name.

13 To view the functions in a table format, click **Table**.

The second column, **Called By**, lists functions that call the function listed in the first column, using the following criteria:

- If a function is called by multiple functions, all functions are listed.
- If a function has no called function, this column is empty.

At the Command Line

To enable a static code metrics report at the command line:

1 Create a code generation configuration object for standalone code generation. For example, to generate a static library:

```
cfg = coder.config('lib');
```

2 Generate code, passing the configuration object as a parameter and specifying the `-report` option. For example:

```
codegen -config cfg -report foo
```

Alternatively,

1 Create a code generation configuration object for standalone code generation. For example, to generate a static library:

```
cfg = coder.config('lib');
```

2 Set the configuration object `GenerateReport` and `GenerateCodeMetricsReport` parameters to `true`.

```
cfg.GenerateReport = true;  
cfg.GenerateCodeMetricsReport = true;
```

3 Generate code, passing the configuration object as a parameter. For example:

```
codegen -config cfg foo
```

Analyze Code Replacements in the Generated Code

When you select the **Code Generation > Report** option **Summarize which blocks triggered code replacements** for an ERT-based model, a Code Replacements Report section is automatically included in the generated HTML report. The Code Replacements Report section documents the code replacement library (CRL) functions that were used for code replacements during code generation, providing a mapping between each replacement instance and the Simulink block that triggered the replacement. You can use the report to:

- Determine which replacement functions were used in the generated code.
- Trace each replacement instance back to the block that triggered the replacement.

The figure below shows a Code Replacements Report generated for the CRL model `rtwdemo_crladdsub`. Each replacement function used is listed with a link to the block that triggered the replacement.

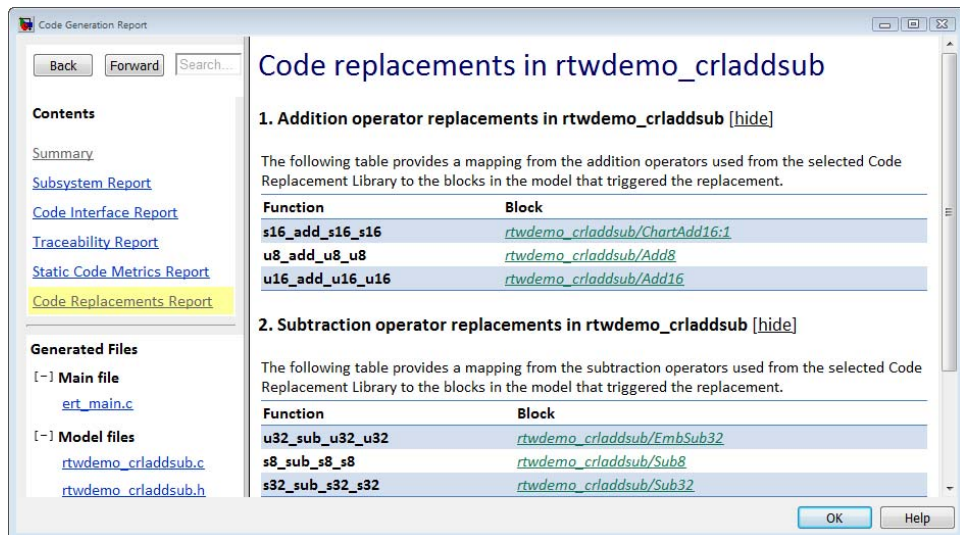

Code replacements in rtwdemo_crladdsub

1. Addition operator replacements in rtwdemo_crladdsub [hide]

The following table provides a mapping from the addition operators used from the selected Code Replacement Library to the blocks in the model that triggered the replacement.

Function	Block
<code>s16_add_s16_s16</code>	rtwdemo_crladdsub/ChartAdd16:1
<code>u8_add_u8_u8</code>	rtwdemo_crladdsub/Add8
<code>u16_add_u16_u16</code>	rtwdemo_crladdsub/Add16

2. Subtraction operator replacements in rtwdemo_crladdsub [hide]

The following table provides a mapping from the subtraction operators used from the selected Code Replacement Library to the blocks in the model that triggered the replacement.

Function	Block
<code>u32_sub_u32_u32</code>	rtwdemo_crladdsub/EmbSub32
<code>s8_sub_s8_s8</code>	rtwdemo_crladdsub/Sub8
<code>s32_sub_s32_s32</code>	rtwdemo_crladdsub/Sub32

If you click a block path in the report, the block that triggered the replacement is highlighted in the model diagram. If the replacement was triggered by a

Stateflow chart or a MATLAB function, a window opens to display the chart or function.

For more information, see [Trace Code Replacements Generated Using Your Code Replacement Library](#).

Generate HTML Report After Build Process

After generating code, if you did not configure your model to create a code generation report, you can generate a code generation report without rebuilding your model.

- 1 In the Simulink editor, select **Code > C/C++ Code > Code Generation Report > Options**. The Configuration Parameters dialog box opens with the Report pane displayed.
- 2 Select any Code Generation Report parameters to be included in the report, such as:
 - **Create code generation report**
 - **Open report automatically**
 - All **Navigation** parameters
 - All **Traceability Report Contents** parameters
 - **Static code metrics**
- 3 In the Simulink editor, select **Code > C/C++ Code > Code Generation Report > Open Model Report**.

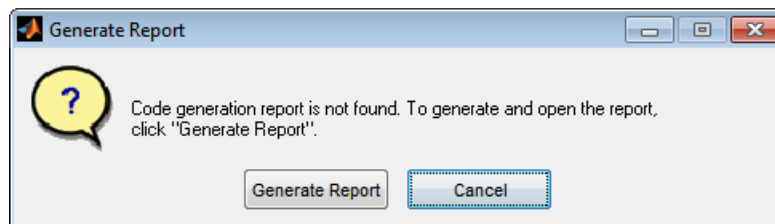

- 4 Click the **Generate Report** button. The code generation report, *model_codgen_rpt.html*, is created in the /html subfolder of the current build folder and automatically opens.

Deployment

- Chapter 19, “Desktops”
- Chapter 20, “Real-Time and Embedded Systems”
- Chapter 21, “Import Custom Code into Model”
- Chapter 22, “Export Code Generated from Model to External Application”
- Chapter 23, “Code Replacement”

Desktops

- “Shared Object Libraries” on page 19-2
- “Non-Real-Time Operating System Integration” on page 19-9

Shared Object Libraries

In this section...

“About Host-Based Shared Libraries” on page 19-2

“Generate Shared Library Version of Model Code” on page 19-3

“Create Application Code to Use Shared Library” on page 19-3

“Host-Based Shared Library Limitations” on page 19-8

About Host-Based Shared Libraries

The Embedded Coder product provides an ERT target, `ert_shrplib.tlc`, for generating a host-based shared library from your Simulink model. Selecting this target allows you to generate a shared library version of your model code for your host platform, either a Windows dynamic link library (.dll) file or a UNIX shared object (.so) file. This feature can be used to package your source code for easy distribution and shared use. The generated .dll or .so file is shareable among different applications and upgradeable without having to recompile the applications that use it.

Code generation for the `ert_shrplib.tlc` target exports

- Variables and signals of type `ExportedGlobal` as data
- Real-time model structure (`model_M`) as data
- Functions essential to executing your model code

To view a list of symbols contained in a generated shared library file, you can

- On Windows, use the Dependency Walker utility, downloadable from <http://www.dependencywalker.com>
- On UNIX, use `nm -D model.so`

To generate and use a host-based shared library, you

- 1 Generate a shared library version of your model code
- 2 Create application code to load and use your shared library file

Generate Shared Library Version of Model Code

This section summarizes the steps to generate a shared library version of your model code.

- 1 To configure your model code for shared use by applications, open your model and select the `ert_shrlib.tlc` target on the **Code Generation** pane of the Configuration Parameters dialog box. Click **OK**.

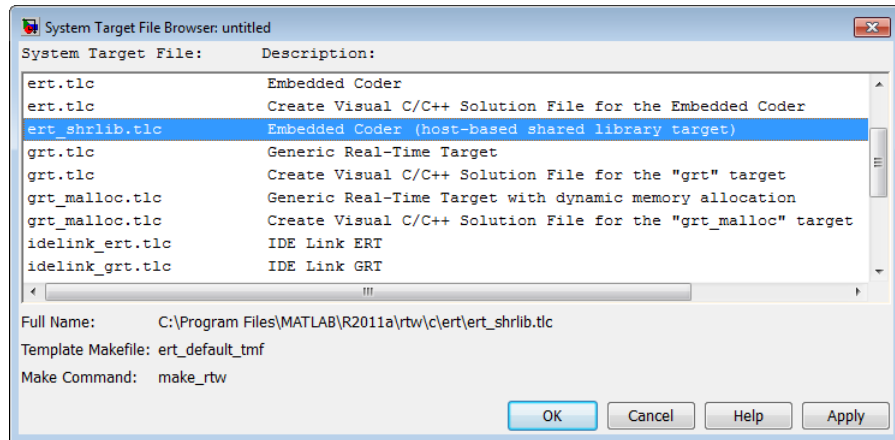

Selecting the `ert_shrlib.tlc` target causes the build process to generate a shared library version of your model code into your current working folder. The selection does not change the code that is generated for your model.

- 2 Build the model.
- 3 After the build completes, you can examine the generated code in the model subfolder, and the `.dll` file or `.so` file that has been generated into your current folder.

Create Application Code to Use Shared Library

To illustrate how application code can load an ERT shared library file and access its functions and data, MathWorks provides the model `rtwdemo_shrlib`. Clicking the blue button in the model runs a script that:

- 1 Builds a shared library file from the model (for example, `rtwdemo_shrlib_win32.dll` on 32-bit Windows)

- 2 Compiles and links an example application, `rtwdemo_shrlib_app`, that will load and use the shared library file
- 3 Executes the example application

Note It is recommended that you change directory to a new or empty folder before running the `rtwdemo_shrlib` script.

The model uses the following example application files, which are located in `matlabroot/toolbox/rtw/rtwdemos/shrlib_demo`.

File	Description
<code>rtwdemo_shrlib_app.h</code>	Example application header file
<code>rtwdemo_shrlib_app.c</code>	Example application that loads and uses the shared library file generated for the model
<code>run_rtwdemo_shrlib_app.m</code>	Script to compile, link, and execute the example application

You can view each of these files by clicking white buttons in the model window. Additionally, running the script places the relevant source and generated code files in your current folder. The files can be used as templates for writing application code for your own ERT shared library files.

The following sections present key excerpts of the example application files.

Example Application Header File

The example application header file `rtwdemo_shrlib_app.h` contains type declarations for the model's external input and output.

```
#ifndef _APP_MAIN_HEADER_
#define _APP_MAIN_HEADER_

typedef struct {
    int32_T Input;
} ExternalInputs_rtwdemo_shrlib;
```

```
typedef struct {
    int32_T Output;
} ExternalOutputs_rtwdemo_shrlib;

#endif /* _APP_MAIN_HEADER_ */
```

Example Application C Code

The example application `rtwdemo_shrlib_app.c` includes the following code for dynamically loading the shared library file. Notice that, depending on platform, the code invokes Windows or UNIX library commands.

```
#if (defined(_WIN32)||defined(_WIN64)) /* WINDOWS */
#include <windows.h>
#define GETSYMBOLADDR GetProcAddress
#define LOADLIB LoadLibrary
#define CLOSELIB FreeLibrary

#else /* UNIX */
#include <dlfcn.h>
#define GETSYMBOLADDR dlsym
#define LOADLIB dlopen
#define CLOSELIB dlclose

#endif

int main()
{
    void* handleLib;
    ...
    #if defined(_WIN64)
        handleLib = LOADLIB("./rtwdemo_shrlib_win64.dll");
    #else
    #if defined(_WIN32)
        handleLib = LOADLIB("./rtwdemo_shrlib_win32.dll");
    #else /* UNIX */
        handleLib = LOADLIB("./rtwdemo_shrlib.so", RTLD_LAZY);
    #endif
    #endif
    #endif
```

```

...
    return(CLOSELIB(handleLib));
}

```

The following code excerpt shows how the C application accesses the model's exported data and functions. Notice the hooks for adding user-defined initialization, step, and termination code.

```

    int32_T i;
...
    void (*mdl_initialize)(boolean_T);
    void (*mdl_step)(void);
    void (*mdl_terminate)(void);

    ExternalInputs_rtwdemo_shrplib (*mdl_Uptr);
    ExternalOutputs_rtwdemo_shrplib (*mdl_Yptr);

    uint8_T (*sum_outptr);
...
#if (defined(LCCDLL) || defined(BORLANDCDLL))
    /* Exported symbols contain leading underscores when DLL is linked with
       LCC or BORLANDC */
    mdl_initialize = (void(*) (boolean_T))GETSYMBOLADDR(handleLib ,
        "_rtwdemo_shrplib_initialize");
    mdl_step       = (void(*) (void))GETSYMBOLADDR(handleLib ,
        "_rtwdemo_shrplib_step");
    mdl_terminate  = (void(*) (void))GETSYMBOLADDR(handleLib ,
        "_rtwdemo_shrplib_terminate");
    mdl_Uptr       = (ExternalInputs_rtwdemo_shrplib*)GETSYMBOLADDR(handleLib ,
        "_rtwdemo_shrplib_U");
    mdl_Yptr       = (ExternalOutputs_rtwdemo_shrplib*)GETSYMBOLADDR(handleLib ,
        "_rtwdemo_shrplib_Y");
    sum_outptr     = (uint8_T*)GETSYMBOLADDR(handleLib , "_sum_out");
#else
    mdl_initialize = (void(*) (boolean_T))GETSYMBOLADDR(handleLib ,
        "rtwdemo_shrplib_initialize");
    mdl_step       = (void(*) (void))GETSYMBOLADDR(handleLib ,
        "rtwdemo_shrplib_step");
    mdl_terminate  = (void(*) (void))GETSYMBOLADDR(handleLib ,
        "rtwdemo_shrplib_terminate");

```

```

mdl_Uptr      =(ExternalInputs_rtwdemo_shrplib*)GETSYMBOLADDR(handleLib ,
                    "rtwdemo_shrplib_U");
mdl_Yptr      =(ExternalOutputs_rtwdemo_shrplib*)GETSYMBOLADDR(handleLib ,
                    "rtwdemo_shrplib_Y");
sum_outptr    =(uint8_T*)GETSYMBOLADDR(handleLib , "sum_out");
#endif

if ((mdl_initialize && mdl_step && mdl_terminate && mdl_Uptr && mdl_Yptr &&
    sum_outptr)) {
    /* === user application initialization function === */
    mdl_initialize(1);
    /* insert other user defined application initialization code here */

    /* === user application step function === */
    for(i=0;i<=12;i++){
        mdl_Uptr->Input = i;
        mdl_step();
        printf("Counter out(sum_out): %d\tAmplifier in(Input): %d\tout(Output): %d\n",
            *sum_outptr, i, mdl_Yptr->Output);
        /* insert other user defined application step function code here */
    }

    /* === user application terminate function === */
    mdl_terminate();
    /* insert other user defined application termination code here */
}
else {
    printf("Cannot locate the specified reference(s) in the shared library.\n");
    return(-1);
}

```

Example Application Script

The application script `run_rtwdemo_shrplib_app.m` loads and rebuilds the model, and then compiles, links, and executes the model's shared library target file. You can view the script source file by opening `rtwdemo_shrplib` and clicking a white button to view source code. The script constructs platform-dependent command strings for compilation, linking, and execution that may apply to your development environment. To run the script, click the blue button.

Host-Based Shared Library Limitations

The following limitations apply to using ERT host-based shared libraries:

- Code generation for the `ert_shrlib.tlc` target exports only the following as data:
 - Variables and signals of type `ExportedGlobal`
 - Real-time model structure (*model_M*)
- Code generation for the `ert_shrlib.tlc` target supports the C language only (not C++). When you select the `ert_shrlib.tlc` target, language selection is greyed out on the **Code Generation** pane of the Configuration Parameters dialog box.
- On Windows systems, the `ert_shrlib` target by default does not generate or retain the `.lib` file for implicit linking (explicit linking is preferred for portability).

You can change the default behavior and retain the `.lib` file by modifying the corresponding template makefile (TMF). If you do this, the generated *model.h* file needs a small modification to be used together with the generated `ert_main.c` for implicit linking. For example, if you are using Visual C++, you need to declare `__declspec(dllimport)` in front of data to be imported implicitly from the shared library file.

- To reconstruct a model simulation using a generated host-based shared library, the application author must maintain the timing between system and shared library function calls in the original application. The timing needs to be consistent so that you can check the simulation and integration results.

Non-Real-Time Operating System Integration

Embedded Coder support non-real-time operating system integration for Linux[®]. For details, see “Working with Linux Target”

Real-Time and Embedded Systems

- “Standalone Programs (No Operating System)” on page 20-2
- “Operating System Integration” on page 20-22
- “Processor Support Packages” on page 20-23

Standalone Programs (No Operating System)

In this section...

“About Standalone Program Execution” on page 20-2

“Generate a Standalone Program” on page 20-2

“Standalone Program Components” on page 20-3

“Main Program” on page 20-3

“rt_OneStep and Scheduling Considerations” on page 20-5

“Static Main Program Module” on page 20-12

“Rate Grouping Compliance and Compatibility Issues” on page 20-16

About Standalone Program Execution

By default, the Embedded Coder software generates *standalone* programs that do not require an external real-time executive or operating system. A standalone program requires minimal modification to be adapted to the target hardware. The standalone program architecture supports execution of models with either single or multiple sample rates.

Generate a Standalone Program

To generate a standalone program:

- 1** In the **Custom templates** section of the **Code Generation > Templates** pane of the Configuration Parameters dialog box, select the **Generate an example main program** option (which is on by default). This enables the **Target operating system** menu.
- 2** From the **Target operating system** menu, select BareBoardExample (the default selection).
- 3** Generate the code.

Different code is generated for multirate models depending on the following factors:

- Whether the model executes in single-tasking or multitasking mode.
- Whether or not reusable code is being generated.

These factors affect the scheduling algorithms used in generated code, and in some cases affect the API for the model entry point functions. The following sections discuss these variants.

Standalone Program Components

The core of a standalone program is the main loop. On each iteration, the main loop executes a background or null task and checks for a termination condition.

The main loop is periodically interrupted by a timer. The function `rt_OneStep` is either installed as a timer interrupt service routine (ISR), or called from a timer ISR at each clock step.

The execution driver, `rt_OneStep`, sequences calls to the `model_step` functions. The operation of `rt_OneStep` differs depending on whether the generating model is single-rate or multirate. In a single-rate model, `rt_OneStep` simply calls the `model_step` function. In a multirate model, `rt_OneStep` prioritizes and schedules execution of blocks according to the rates at which they run.

Main Program

- “Overview of Operation” on page 20-3
- “Guidelines for Modifying the Main Program” on page 20-4

Overview of Operation

The following pseudocode shows the execution of a main program.

```
main()
{
    Initialization (including installation of rt_OneStep as an
        interrupt service routine for a real-time clock)
    Initialize and start timer hardware
    Enable interrupts
```

```
While(not Error) and (time < final time)
    Background task
EndWhile
Disable interrupts (Disable rt_OneStep from executing)
Complete any background tasks
Shutdown
}
```

The pseudocode is a design for a harness program to drive your model. The main program only partially implements this design. You must modify it according to your specifications.

Guidelines for Modifying the Main Program

This section describes the minimal modifications you should make in your production version of the main program module to implement your harness program.

- 1** Call *model_initialize*.
- 2** Initialize target-specific data structures and hardware, such as ADCs or DACs.
- 3** Install *rt_OneStep* as a timer ISR.
- 4** Initialize timer hardware.
- 5** Enable timer interrupts and start the timer.

Note *rtModel* is not in a valid state until *model_initialize* has been called. Servicing of timer interrupts should not begin until *model_initialize* has been called.

- 6** Optionally, insert background task calls in the main loop.
- 7** On termination of the main loop (if applicable):
 - Disable timer interrupts.
 - Perform target-specific cleanup such as zeroing DACs.

- Detect and handle errors. Note that even if your program is designed to run indefinitely, you may need to handle severe error conditions, such as timer interrupt overruns.

You can use the macros `rtmGetErrorStatus` and `rtmSetErrorStatus` to detect and signal errors.

rt_OneStep and Scheduling Considerations

- “Overview of Operation” on page 20-5
- “Single-Rate Single-Tasking Operation” on page 20-6
- “Multirate Multitasking Operation” on page 20-7
- “Multirate Single-Tasking Operation” on page 20-10
- “Guidelines for Modifying `rt_OneStep`” on page 20-10

Overview of Operation

The operation of `rt_OneStep` depends upon

- Whether your model is single-rate or multirate. In a single-rate model, the sample times of all blocks in the model, and the model’s fixed step size, are the same. A model in which the sample times and step size do not meet these conditions is termed multirate.
- Your model’s solver mode (`SingleTasking` versus `MultiTasking`)

Permitted Solver Modes for Embedded Coder® Targeted Models on page 20-6 summarizes the permitted solver modes for single-rate and multirate models. Note that for a single-rate model, only `SingleTasking` solver mode is allowed.

Permitted Solver Modes for Embedded Coder Targeted Models

Mode	Single-Rate	Multirate
SingleTasking	Allowed	Allowed
MultiTasking	Disallowed	Allowed
Auto	Allowed (defaults to SingleTasking)	Allowed (defaults to MultiTasking)

The generated code for `rt_OneStep` (and associated timing data structures and support functions) is tailored to the number of rates in the model and to the solver mode. The following sections discuss each possible case.

Single-Rate Single-Tasking Operation

The only valid solver mode for a single-rate model is `SingleTasking`. Such models run in “single-rate” operation.

The following pseudocode shows the design of `rt_OneStep` in a single-rate program.

```
rt_OneStep()
{
    Check for interrupt overflow or other error
    Enable "rt_OneStep" (timer) interrupt
    Model_Step() -- Time step combines output, logging, update
}
```

For the single-rate case, the generated `model_step` function is

```
void model_step(void)
```

Single-rate `rt_OneStep` is designed to execute `model_step` within a single clock period. To enforce this timing constraint, `rt_OneStep` maintains and checks a timer overrun flag. On entry, timer interrupts are disabled until the overrun flag and other error conditions have been checked. If the overrun flag is clear, `rt_OneStep` sets the flag, and proceeds with timer interrupts enabled.

The overrun flag is cleared only upon successful return from *model_step*. Therefore, if *rt_OneStep* is reinterrupted before completing *model_step*, the re-interruption is detected through the overrun flag.

Re-interruption of *rt_OneStep* by the timer is an error condition. If this condition is detected *rt_OneStep* signals an error and returns immediately. (Note that you can change this behavior if you want to handle the condition differently.)

Note that the design of *rt_OneStep* assumes that interrupts are disabled before *rt_OneStep* is called. *rt_OneStep* should be noninterruptible until the interrupt overflow flag has been checked.

Multirate Multitasking Operation

In a multirate multitasking system, code generation uses a prioritized, preemptive multitasking scheme to execute the different sample rates in your model.

The following pseudocode shows the design of *rt_OneStep* in a multirate multitasking program.

```
rt_OneStep()
{
    Check for base-rate interrupt overrun
    Enable "rt_OneStep" interrupt
    Determine which rates need to run this time step

    Model_Step0()          -- run base-rate time step code

    For N=1:NumTasks-1    -- iterate over sub-rate tasks
        If (sub-rate task N is scheduled)
            Check for sub-rate interrupt overrun
            Model_StepN()  -- run sub-rate time step code
        EndIf
    EndFor
}
```

Task Identifiers. The execution of blocks having different sample rates is broken into tasks. Each block that executes at a given sample rate is assigned a *task identifier* (`tid`), which associates it with a task that executes at that rate. Where there are `NumTasks` tasks in the system, the range of task identifiers is `0..NumTasks-1`.

Prioritization of Base-Rate and Subrate Tasks. Tasks are prioritized, in descending order, by rate. The *base-rate* task is the task that runs at the fastest rate in the system (the hardware clock rate). The base-rate task has highest priority (`tid 0`). The next fastest task (`tid 1`) has the next highest priority, and so on down to the slowest, lowest priority task (`tid NumTasks-1`).

The slower tasks, running at submultiples of the base rate, are called *subrate* tasks.

Rate Grouping and Rate-Specific `model_step` Functions. In a single-rate model, the block output computations are performed within a single function, `model_step`. For multirate, multitasking models, the code generator tries to use a different strategy. This strategy is called *rate grouping*. Rate grouping generates separate `model_step` functions for the base rate task and each subrate task in the model. The function naming convention for these functions is

```
model_stepN
```

where *N* is a task identifier. For example, for a model named `my_model` that has three rates, the following functions are generated:

```
void my_model_step0 (void);  
void my_model_step1 (void);  
void my_model_step2 (void);
```

Each `model_stepN` function executes the blocks sharing `tid N`; in other words, the block code that executes within task *N* is grouped into the associated `model_stepN` function.

Scheduling `model_stepN` Execution. On each clock tick, `rt_OneStep` maintains scheduling counters and *event flags* for each subrate task. The counters are implemented as `taskCounter` arrays indexed on `tid`. The event flags are implemented as arrays indexed on `tid`.

The scheduling counters and task flags for sub-rates are maintained by `rt_OneStep`. The scheduling counters are basically clock rate dividers that count up the sample period associated with each sub-rate task. A pair of tasks that exchanges data maintains an interaction flag at the faster rate. Task interaction flags indicate that both fast and slow tasks are scheduled to run.

The event flags indicate whether or not a given task is scheduled for execution. `rt_OneStep` maintains the event flags based on a task counter that is maintained by code in the main program module for the model. When a counter indicates that a task's sample period has elapsed, the main code sets the event flag for that task.

On each invocation, `rt_OneStep` updates its scheduling data structures and steps the base-rate task (`rt_OneStep` calls `model_step0` because the base-rate task must execute on every clock step). Then, `rt_OneStep` iterates over the scheduling flags in `tid` order, unconditionally calling `model_stepN` for any task whose flag is set. The tasks are executed in order of priority.

Preemption. Note that the design of `rt_OneStep` assumes that interrupts are disabled before `rt_OneStep` is called. `rt_OneStep` should be noninterruptible until the base-rate interrupt overflow flag has been checked (see pseudocode above).

The event flag array and loop variables used by `rt_OneStep` are stored as local (stack) variables. Therefore, `rt_OneStep` is reentrant. If `rt_OneStep` is reinterrupted, higher priority tasks preempt lower priority tasks. Upon return from interrupt, lower priority tasks resume in the previously scheduled order.

Overrun Detection. Multirate `rt_OneStep` also maintains an array of timer overrun flags. `rt_OneStep` detects timer overrun, per task, by the same logic as single-rate `rt_OneStep`.

Note If you have developed multirate S-functions, or if you use a customized static main program module, see “Rate Grouping Compliance and Compatibility Issues” on page 20-16 for information about how to adapt your code for rate grouping compatibility. This adaptation lets your multirate, multitasking models generate more efficient code.

Multirate Single-Tasking Operation

In a multirate single-tasking program, by definition, sample times in the model must be an integer multiple of the model's fixed-step size.

In a multirate single-tasking program, blocks execute at different rates, but under the same task identifier. The operation of `rt_OneStep`, in this case, is a simplified version of multirate multitasking operation. Rate grouping is not used. The only task is the base-rate task. Therefore, only one `model_step` function is generated:

```
void model_step(void)
```

On each clock tick, `rt_OneStep` checks the overrun flag and calls `model_step`. The scheduling function for a multirate single-tasking program is `rate_scheduler` (rather than `rate_monotonic_scheduler`). The scheduler maintains scheduling counters on each clock tick. There is one counter for each sample rate in the model. The counters are implemented in an array (indexed on `tid`) within the `Timing` structure within `rtModel`.

The counters are clock rate dividers that count up the sample period associated with each subrate task. When a counter indicates that a sample period for a given rate has elapsed, `rate_scheduler` clears the counter. This condition indicates that blocks running at that rate should execute on the next call to `model_step`, which is responsible for checking the counters.

Guidelines for Modifying `rt_OneStep`

`rt_OneStep` does not require extensive modification. The only required modification is to reenable interrupts after the overrun flags and error conditions have been checked. If applicable, you should also

- Save and restore your FPU context on entry and exit to `rt_OneStep`.
- Set model inputs associated with the base rate before calling `model_step0`.
- Get model outputs associated with the base rate after calling `model_step0`.

Note If you modify `rt_OneStep` to read a value from a continuous output port after each base-rate model step, see the relevant cautionary guideline below.

- In a multirate, multitasking model, set model inputs associated with subrates before calling `model_stepN` in the subrate loop.
- In a multirate, multitasking model, get model outputs associated with subrates after calling `model_stepN` in the subrate loop.

Comments in `rt_OneStep` indicate the place to add your code.

In multirate `rt_OneStep`, you can improve performance by unrolling `for` and `while` loops.

In addition, you may choose to modify the overrun behavior to continue execution after error recovery is complete.

Also observe the following cautionary guidelines:

- You should not modify the way in which the counters, event flags, or other timing data structures are set in `rt_OneStep`, or in functions called from `rt_OneStep`. The `rt_OneStep` timing data structures (including `rtModel`) and logic are critical to the operation of the generated program.
- If you have customized the main program module to read model outputs after each base-rate model step, be aware that selecting model options **Support: continuous time** and **Single output/update function** together may cause output values read from `main` for a continuous output port to differ slightly from the corresponding output values in the model's logged data. This is because, while logged data is a snapshot of output at major time steps, output read from `main` after the base-rate model step potentially reflects intervening minor time steps. To eliminate the discrepancy, either separate the generated output and update functions (clear the **Single output/update function** option) or place a Zero-Order Hold block before the continuous output port.

Static Main Program Module

- “Overview” on page 20-12
- “Rate Grouping and the Static Main Program” on page 20-13
- “Modify the Static Main Program” on page 20-14

Overview

In most cases, the easiest strategy for deploying generated code is to use the **Generate an example main program option** to generate the `ert_main.c` or `.cpp` module (see “Generate a Standalone Program” on page 20-2).

However, if you turn the **Generate an example main program** option off, you can use the module `matlabroot/rtw/c/src/common/rt_main.c` as a template example for developing your embedded applications. The module is not part of the generated code; it is provided as a basis for your custom modifications, and for use in simulation. If your existing applications depend upon a static `ert_main.c` (developed in releases before R2012b) or `rt_main.c`, you may need to continue using a static main program module.

When developing applications using a static `rt_main.c`, you should copy this module to your working folder and rename it to `model_rt_main.c` before making modifications. Also, you must modify the template makefile such that the build process creates `model_rt_main.obj` (on UNIX, `model_rt_main.o`) in the build folder.

The static `rt_main.c` contains

- `rt_OneStep`, a timer interrupt service routine (ISR). `rt_OneStep` calls `model_step` to execute processing for one clock period of the model.
- A skeletal main function. As provided, `main` is useful in simulation only. You must modify `main` for real-time interrupt-driven execution.

For single-rate models, the operation of `rt_OneStep` and the main function are essentially the same in the static `rt_main.c` as they are in the autogenerated version described in “About Standalone Program Execution” on page 20-2. For multirate, multitasking models, however, the static and generated code is slightly different. The next section describes this case.

Rate Grouping and the Static Main Program

Targets based on the ERT target sometimes use a static `rt_main` module and disallow use of the **Generate an example main program** option. This is done because target-specific modifications have been added to the static `rt_main.c`, and these modifications would not be preserved if the main program were regenerated.

Your `rt_main` module may or may not use rate grouping compatible `model_stepN` functions. If your main module is based on the static `rt_main.c` module, it does not use rate-specific `model_stepN` function calls. The static `rt_main.c` module uses the old-style `model_step` function, passing in a task identifier:

```
void model_step(int_T tid);
```

By default, when the **Generate an example main program** option is off, the ERT target generates a `model_step` “wrapper” for multirate, multitasking models. The purpose of the wrapper is to interface the rate-specific `model_stepN` functions to the old-style call. The wrapper code dispatches to the `model_stepN` call with a `switch` statement, as in the following example:

```
void mymodel_step(int_T tid) /* Sample time: */
{
    switch(tid) {
        case 0 :
            mymodel_step0();
            break;
        case 1 :
            mymodel_step1();
            break;
        case 2 :
            mymodel_step2();
            break;
        default :
            break;
    }
}
```

The following pseudocode shows how `rt_OneStep` calls `model_step` from the static main program in a multirate, multitasking model.

```
rt_OneStep()
{
    Check for base-rate interrupt overflow
    Enable "rt_OneStep" interrupt
    Determine which rates need to run this time step

    ModelStep(tid=0)    --base-rate time step

    For N=1:NumTasks-1 -- iterate over sub-rate tasks
        Check for sub-rate interrupt overflow
        If (sub-rate task N is scheduled)
            ModelStep(tid=N)    --sub-rate time step
        EndIf
    EndFor
}
```

You can use the TLC variable `RateBasedStepFcn` to specify that only the rate-based step functions are generated, without the wrapper function. If your target calls the rate grouping compatible `model_stepN` function directly, set `RateBasedStepFcn` to 1. In this case, the wrapper function is not generated.

You should set `RateBasedStepFcn` prior to the `%include "codegenentry.tlc"` statement in your system target file. Alternatively, you can set `RateBasedStepFcn` in your `target_settings.tlc` file.

Modify the Static Main Program

As with the generated `ert_main.c` or `.cpp`, you should make a few modifications to the main loop and `rt_OneStep`. See “Guidelines for Modifying the Main Program” on page 20-4 and “Guidelines for Modifying `rt_OneStep`” on page 20-10.

Also, you should replace the `rt_OneStep` call in the main loop with a background task call or null statement.

Other modifications you may need to make are

- If your model has multiple rates, the generated code might not operate as expected unless:
 - The multirate scheduling code is removed. The relevant code is tagged with the keyword `REMOVE` in comments (see also the Version 3.0 comments in `rt_main.c`).
 - Use the `MODEL_SETEVENTS` macro (defined in `rt_main.c`) to set the event flags instead of accessing the flags directly. The relevant code is tagged with the keyword `REPLACE` in comments.

Note The `MODEL_SETEVENTS` macro provides a way to call the model entry function `model_SetEventsForThisBaseStep` from a static main program. Versions of the Embedded Coder software prior to R2008a generated the `model_SetEventsForThisBaseStep` function for multirate, multitasking models, but it is no longer generated. You should avoid using `MODEL_SETEVENTS` unless you have a specific need for it.

- If applicable, follow comments in the code regarding where to add code for reading/writing model I/O and saving/restoring FPU context.

Note If you modify `rt_main.c` to read a value from a continuous output port after each base-rate model step, see the relevant cautionary guideline in “Guidelines for Modifying `rt_OneStep`” on page 20-10.

- When the **Generate an example main program** option is off `rtmodel.h` is generated to provide an interface between the main module and generated model code. If you create your own static main program module, you would normally include `rtmodel.h`.

Alternatively, you can suppress generation of `rtmodel.h`, and include `model.h` directly in your main module. To suppress generation of `rtmodel.h`, use the following statement in your system target file:

```
%assign AutoBuildProcedure = 0
```

- If you have cleared the **Terminate function required** option, remove or comment out the following in your production version of `rt_main.c`:
 - The `#if TERMFCN...` compile-time error check
 - The call to `MODEL_TERMINATE`
- If you do *not* want to combine output and update functions, clear the **Single output/update function** option and make the following changes in your production version of `rt_main.c`:
 - Replace calls to `MODEL_STEP` with calls to `MODEL_OUTPUT` and `MODEL_UPDATE`.
 - Remove the `#if ONESTEPFCN...` error check.
- The static `rt_main.c` module does not support the **Generate Reusable Code** option. Use this option only if you are generating a main program. The following error check raises a compile-time error if **Generate Reusable Code** is used illegally.

```
#if MULTI_INSTANCE_CODE==1
```

Rate Grouping Compliance and Compatibility Issues

- “Main Program Compatibility” on page 20-16
- “Make Your S-Functions Rate Grouping Compliant” on page 20-16

Main Program Compatibility

When the **Generate an example main program** option is off, code generation produces slightly different rate grouping code, for compatibility with the older static `ert_main.c` module. See “Rate Grouping and the Static Main Program” on page 20-13 for details.

Make Your S-Functions Rate Grouping Compliant

Built-in Simulink blocks, as well as DSP System Toolbox blocks, are compliant with the requirements for generating rate grouping code. However, user-written multirate inlined S-functions may not be rate grouping compliant. Noncompliant blocks generate less efficient code, but are otherwise compatible with rate grouping. To take full advantage of the efficiency of rate grouping, your multirate inlined S-functions must be upgraded to be

fully rate grouping compliant. You should upgrade your TLC S-function implementations, as described in this section.

Use of noncompliant multirate blocks to generate rate-grouping code generates dead code. This can cause two problems:

- Reduced code efficiency.
- Warning messages issued at compile time. Such warnings are caused when dead code references temporary variables before initialization. Since the dead code does not run, this problem does not affect the run-time behavior of the generated code.

To make your S-functions rate grouping compliant, you can use the following TLC functions to generate `ModelOutputs` and `ModelUpdate` code, respectively:

```
OutputsForTID(block, system, tid)  
UpdateForTID(block, system, tid)
```

The code listings below illustrate generation of output computations without rate grouping (Listing 1) and with rate grouping (Listing 2). Note the following:

- The `tid` argument is a task identifier (`0..NumTasks-1`).
- Only code guarded by the `tid` passed in to `OutputsForTID` is generated. The `if (%<LibIsSFcnSampleHit(portName)>)` test is not used in `OutputsForTID`.
- When generating rate grouping code, `OutputsForTID` and/or `UpdateForTID` is called during code generation. When generating non-rate-grouping code, `Outputs` and/or `Update` is called.
- In rate grouping compliant code, the top-level `Outputs` and/or `Update` functions call `OutputsForTID` and/or `UpdateForTID` functions for each rate (`tid`) involved in the block. The code returned by `OutputsForTID` and/or `UpdateForTID` must be guarded by the corresponding `tid` guard:

```
if (%<LibIsSFcnSampleHit(portName)>)
```

as in Listing 2.

Listing 1: Outputs Code Generation Without Rate Grouping.

```
%% multirate_blk.tlc

%implements "multirate_blk" "C"

%% Function: mdlOutputs =====
%% Abstract:
%%
%% Compute the two outputs (input signal decimated by the
%% specified parameter). The decimation is handled by sample times.
%% The decimation is only performed if the block is enabled.
%% Each ports has a different rate.
%%
%% Note, the usage of the enable should really be protected such that
%% Neach task has its own enable state. In this example, the enable
%% occurs immediately which may or may not be the expected behavior.
%%
```

```

%function Outputs(block, system) Output
/* %<Type> Block: %<Name> */
%assign enable = LibBlockInputSignal(0, "", "", 0)
{
    int_T *enabled = &%<LibBlockIWork(0, "", "", 0)>;

    %if LibGetSFcnTIDType("InputPortIdx0") == "continuous"
        %% Only check the enable signal on a major time step.
        if (%<LibIsMajorTimeStep()> && ...
            %<LibIsSFcnSampleHit("InputPortIdx0")>) {
            *enabled = (%<enable> > 0.0);
        }
    %else
        if (%<LibIsSFcnSampleHit("InputPortIdx0")>) {
            *enabled = (%<enable> > 0.0);
        }
    %endif

    if (*enabled) {
        %assign signal = LibBlockInputSignal(1, "", "", 0)
        if (%<LibIsSFcnSampleHit("OutputPortIdx0")>) {
            %assign y = LibBlockOutputSignal(0, "", "", 0)
            %<y> = %<signal>;
        }
        if (%<LibIsSFcnSampleHit("OutputPortIdx1")>) {
            %assign y = LibBlockOutputSignal(1, "", "", 0)
            %<y> = %<signal>;
        }
    }
}

%endfunction
%% [EOF] sfun_multirate.tlc

```

Listing 2: Outputs Code Generation With Rate Grouping.

```

%% example_multirateblk.tlc

%implements "example_multirateblk" "C"

```

```

%% Function: mdlOutputs =====
%% Abstract:
%%
%% Compute the two outputs (the input signal decimated by the
%% specified parameter). The decimation is handled by sample times.
%% The decimation is only performed if the block is enabled.
%% All ports have different sample rate.
%%
%% Note: the usage of the enable should really be protected such that
%% each task has its own enable state. In this example, the enable
%% occurs immediately which may or may not be the expected behavior.
%%
%function Outputs(block, system) Output

%assign portIdxName = ["InputPortIdx0", "OutputPortIdx0", "OutputPortIdx1"]
%assign portTID      = [%<LibGetGlobalTIDFromLocalSFcnTID("InputPortIdx0")>, ...
                        %<LibGetGlobalTIDFromLocalSFcnTID("OutputPortIdx0")>, ...
                        %<LibGetGlobalTIDFromLocalSFcnTID("OutputPortIdx1")>]

%foreach i = 3
    %assign portName = portIdxName[i]
    %assign tid      = portTID[i]
    if (%<LibIsSFcnSampleHit(portName)>) {
        %<OutputsForTID(block, system, tid)>
    }
%endforeach

%endfunction

%function OutputsForTID(block, system, tid) Output
/* %<Type> Block: %<Name> */
%assign enable = LibBlockInputSignal(0, "", "", 0)
%assign enabled = LibBlockIWork(0, "", "", 0)
%assign signal = LibBlockInputSignal(1, "", "", 0)

%switch(tid)
    %case LibGetGlobalTIDFromLocalSFcnTID("InputPortIdx0")
        %if LibGetSFcnTIDType("InputPortIdx0") == "continuous"

```

```
        %% Only check the enable signal on a major time step.
        if (<LibIsMajorTimeStep()>) {
            <enabled> = (<enable> > 0.0);
        }
    %else
        <enabled> = (<enable> > 0.0);
    %endif
    %break
%case LibGetGlobalTIDFromLocalSFcnTID("OutputPortIdx0")
    if (<enabled>) {
        %assign y = LibBlockOutputSignal(0, "", "", 0)
        <y> = <signal>;
    }
    %break
%case LibGetGlobalTIDFromLocalSFcnTID("OutputPortIdx1")
    if (<enabled>) {
        %assign y = LibBlockOutputSignal(1, "", "", 0)
        <y> = <signal>;
    }
    %break
%default
    %% error it out
%endswitch

%endfunction

%% [EOF] sfun_multirate.tlc
```

Operating System Integration

Embedded Coder supports integration for Linux, Texas Instruments™ DSP/BIOS™, and Wind River VxWorks. For details, see “Embedded Systems”.

Processor Support Packages

Embedded Coder supports integration for specific processors. For details, see “Embedded Systems”.

Import Custom Code into Model

Generate S-Function Wrappers

In this section...

“About S-Function Wrapper Generation” on page 21-2

“Create a SIL Block” on page 21-3

“S-Function Wrapper Generation Limitations” on page 21-3

About S-Function Wrapper Generation

An S-function wrapper is an S-function that calls your C or C++ code from within Simulink. S-function wrappers provide a standard interface between Simulink and externally written code, allowing you to integrate your code into a model with minimal modification. This is useful for software-in-the-loop (SIL) code verification (validating your generated code in Simulink), as well as for simulation acceleration purposes (see “Use a SIL or PIL Block” on page 31-19). For more information, see “About S-Functions and Code Generation”.

Using the **Create block** parameter, on the **Code Generation > Verification** pane, you can build in one automated step:

- A noninlined C or C++ MEX S-function wrapper that calls generated code
- A model with a SIL block. This block, which contains the generated S-function, is ready for use with other blocks or models

When the **Create block** parameter is set to **SIL**, the build process generates an additional source code file, *model_sf.c* or *.cpp*, in the build folder. This module contains the S-function that calls the generated code that you deploy. You can use this S-function within Simulink.

The build process then compiles and links *model_sf.c* or *.cpp* with *model.c* or *.cpp* and the other generated code modules, building a MEX-file. The MEX-file is named *model_sf.mexext*. (*mexext* is the file extension for MEX-files on your platform, as given by the MATLAB `mexext` command.) The MEX-file is stored in your working folder. Finally, the build process creates and opens an untitled model containing the SIL block with the generated S-function.

Note To generate a wrapper S-function for a subsystem, you can use a right-click subsystem build. Right-click the subsystem block in your model, select **C/C++ Code > Generate S-Function**, and in the Generate S-Function dialog box, select **Create Software-In-the-Loop (SIL) block** and click **Build**.

Create a SIL Block

To create a SIL block with the S-function wrapper for your generated code, open your ERT-based Simulink model and do the following:

- 1 Open the Configuration Parameters dialog box.
- 2 Select the **Code Generation > Verification** pane.
- 3 From the **Create block** drop-down list, select **SIL**.
- 4 Configure the other code generation options as required.
- 5 To initialize the memory for the S-function to zero, you must clear the following options in the **Data initialization** section of the **Optimization > General** pane:
 - “**Remove root level I/O zero initialization**”
 - “**Remove internal data zero initialization**”
 - “**Use memset to initialize floats and doubles to 0.0**”
- 6 Select the **Code Generation** pane, and click **Build**.
- 7 When the build process completes, an untitled model window opens. This model contains a SIL block with the generated S-function.
- 8 Save the new model.
- 9 You can now use the SIL block with other blocks or models in Simulink.

S-Function Wrapper Generation Limitations

The following limitations apply to Embedded Coder S-function wrapper generation:

- Continuous sample time is not supported. The **Support continuous time** option should not be selected when creating a SIL block.
- Models that contain S-function blocks for which the S-function is not inlined with a TLC file are not supported when creating a SIL block.
- You cannot use multiple instances of a SIL block within a model, because the code uses static memory allocation. Each instance potentially can overwrite global data values of the others.
- SIL blocks can be used with other blocks and models for SIL code verification and simulation acceleration, but they cannot be used for code generation.
- A MEX S-function wrapper must only be used in the version of MATLAB in which the wrapper is created.

Export Code Generated from Model to External Application

- “Export Function-Call Subsystems” on page 22-2
- “Control Generation of Function Prototypes” on page 22-14
- “C++ Encapsulation Interface Control” on page 22-16

Export Function-Call Subsystems

In this section...
“Exporting Function-Call Subsystems” on page 22-2
“Requirements for Exporting Function-Call Subsystems” on page 22-3
“Techniques for Exporting Function-Call Subsystems” on page 22-6
“Optimize Exported Function-Call Subsystems” on page 22-8
“Export Functions That Depend on Elapsed Time” on page 22-8
“Function-Call Subsystem Export” on page 22-9
“Function-Call Subsystems Export Limitations” on page 22-12

Exporting Function-Call Subsystems

Embedded Coder software provides code export capabilities that you can use to

- Automatically generate code for
 - A function-call subsystem that contains only blocks that support code generation
 - A virtual subsystem that contains only such subsystems and a few other types of blocks
- Create a SIL block that represents the generated code

You can use these capabilities only if the subsystem and its interface to the Simulink model conform to certain requirements and constraints, as described in “Requirements for Exporting Function-Call Subsystems” on page 22-3. For limitations that apply, see “Function-Call Subsystems Export Limitations” on page 22-12. To see an example of exported function-call subsystems, type `rtwdemo_export_functions` in the MATLAB Command Window.

Note For models designed in earlier releases, Embedded Coder software also supports the ability to export functions from triggered subsystems. In general, the requirements and limitations stated for exporting functions from function-call subsystems also apply to exporting functions from triggered subsystems, with the following exceptions:

- Triggered subsystems from which you intend to export functions must be encapsulated in a single top-level virtual subsystem.
 - Triggered subsystems do not have to meet the requirements in “Trigger Signals Require a Common Source” on page 22-4 and “Requirements for Exported Virtual Subsystems” on page 22-5.
 - The section “Export Functions That Depend on Elapsed Time” on page 22-8 is not applicable to exporting functions from triggered subsystems.
-

Additional Information

See the following in the Simulink documentation for additional information relating to exporting function-call subsystems:

- “Systems and Subsystems”
- “Signals”
- “Triggered Subsystems”
- “Function-Call Subsystems and S-Functions”
- “Host-Specific Code”

If you want to use Stateflow blocks to trigger exportable function-call subsystems, you may also need information from “Interface with Simulink”.

Requirements for Exporting Function-Call Subsystems

To be exportable as code, a function-call subsystem, or a virtual subsystem that contains such subsystems, must meet certain requirements. Most requirements are similar for either type of export, but some apply only to

virtual subsystems. The requirements for Simulink code generation also apply.

For brevity, *exported subsystem* in this section means only an exported function-call subsystem or an exported virtual subsystem that contains such subsystems. The requirements listed do not necessarily apply to other types of exported subsystems.

Requirements for Exported Subsystems

These requirements apply to both exported function-call subsystems and exported virtual subsystems that contain such subsystems.

Blocks Must Support Code Generation. All blocks within an exported subsystem must support code generation. However, blocks outside the subsystem need not support code generation unless they will be converted to code in some other context.

Blocks Must Not Use Absolute Time. Certain blocks use absolute time. Blocks that use absolute time are not supported in exported function-call subsystems. For a complete list of such blocks, see “Limitations on the Use of Absolute Time” in the Simulink Coder documentation.

Blocks Must Not Depend on Elapsed Time. Certain blocks, like the Sine Wave block and Discrete Integrator block, depend on elapsed time. If an exported function-call subsystem contains a block that depends on elapsed time, the subsystem must specify periodic execution. See “Export Functions That Depend on Elapsed Time” on page 22-8 in the Simulink Coder documentation.

Trigger Signals Require a Common Source. If more than one trigger signal crosses the boundary of an exported system, all of the trigger signals must be periodic and originate from the same function-call initiator.

Trigger Signals Must Be Scalar. A trigger signal that crosses the boundary of an exported subsystem must be scalar. Input and output data signals that do not act as triggers need not be scalar.

Data Signals Must Be Nonvirtual. A data signal that crosses the boundary of an exported system cannot be a virtual bus, and cannot be implemented as a Goto-From connection. Every data signal crossing the export boundary must be scalar, muxed, or a nonvirtual bus.

Requirements for Exported Virtual Subsystems

These requirements apply only to exported virtual subsystems that contain function-call subsystems.

Virtual Subsystem Must Use Only Permissible Blocks. The top level of an exported virtual subsystem that contains function-call subsystem blocks can contain only the following other types of blocks:

- Input and Output blocks (ports)
- Constant blocks (including blocks that resolve to constants, such as Add)
- Merge blocks
- Virtual connection blocks (Mux, Demux, Bus Creator, Bus Selector, Signal Specification)
- Signal-viewer blocks, such as Scope blocks

These restrictions do *not* apply within function-call subsystems, whether or not they appear in a virtual subsystem. They apply only at the top level of an exported virtual subsystem that contains one or more function-call subsystems.

Constant Blocks Must Be Inlined. When a constant block appears at the top level of an exported virtual subsystem, the containing model must check **Inline parameters** on the **Optimization > Signals and Parameters** pane of the Configuration Parameters dialog box.

Constant Outputs Must Specify a Storage Class. When a constant signal drives an output port of an exported virtual subsystem, the signal must specify a storage class.

Techniques for Exporting Function-Call Subsystems

- “General Workflow” on page 22-6
- “Specify a Custom Initialize Function Name” on page 22-7
- “Specify a Custom Description” on page 22-7

General Workflow

To export a function-call subsystem, or a virtual subsystem that contains function-call subsystems,

- 1** Check that the subsystem to be exported satisfies the “Requirements for Exporting Function-Call Subsystems” on page 22-3.
- 2** In the Configuration Parameters dialog box:
 - a** On the **Code Generation** pane, specify an ERT code generation target such as `ert.tlc`.
 - b** If you want a SIL block with the generated code, go to the **Verification** pane and, from the **Create block** drop-down list, select **SIL**.
 - c** Click **OK** or **Apply**.
- 3** Right-click the subsystem block and choose **C/C++ Code > Export Functions** from the context menu.

The **Build code for subsystem: *Subsystem*** dialog box appears. This dialog box is not specific to exporting function-call subsystems, and generating code does not require entering information in the box.

- 4** Click **Build**.

The MATLAB Command Window displays messages similar to the code generation sequence. Simulink generates code and places it in the working folder.

If you set **Create block** to **SIL** in step 2b, Simulink opens a new window that contains an S-function block that represents the generated code. This block has the same size, shape, and connectors as the original subsystem.

Code generation and optional block creation are now complete. You can test and use the code and optional block as you could for generated ERT code and S-function block.

Specify a Custom Initialize Function Name

You can specify a custom name for the initialize function of your exported function as an argument to the `rtwbuild` command. When used for this purpose, the command takes the following form:

```
blockHandle = rtwbuild('subsystem', 'Mode', 'ExportFunctionCalls',..
                    'ExportFunctionInitializeFunctionName', 'fcnname')
```

where *fcnname* specifies the desired function name. For example, if you specify the name 'myinitfcn', the build process emits code similar to the following:

```
/* Model initialize function */
void myinitfcn(void){
...
}
```

Specify a Custom Description

You can enter a custom description for an exported function using the Block Properties dialog box of an Inport block. To do this, go to the subsystem that is to be exported as a function, right-click on the Inport block that drives the control port of the subsystem, and select **Properties**. In the **General** tab, use the **Description** field to enter your descriptive text. During function export, the text you enter is emitted to the generated code in the header for the Inport block. For example, if you open the example program `rtwdemo_export_functions` and enter a description in the Block Properties dialog box for port `t_1tic_A`, code similar to the following is emitted:

```
/*
 * Output and update for exported function: t_1tic_A
 *
 * My custom description of the exported function
 */
void t_1tic_A(void)
{
```

```
...  
}
```

Optimize Exported Function-Call Subsystems

To optimize the code generated for a function-call subsystem or virtual block that contains such subsystems, you can

- Specify a storage class for every input signal and output signal that crosses the boundary of the subsystem.
- For each function-call subsystem to be exported (whether directly or within a virtual subsystem):
 - 1 Right-click the subsystem and choose **Block Parameters (Subsystem)** from the context menu.
 - 2 Select the **Code Generation** tab and set the **Function packaging** parameter to Auto.
 - 3 Click **OK** or **Apply**.

Export Functions That Depend on Elapsed Time

Some blocks, such as the Sine Wave block (if sample-based) and the Discrete-Time Integrator block, depend on elapsed time. See “Absolute and Elapsed Time Computation” in the Simulink Coder documentation for more information.

When a block that depends on elapsed time exists in a function-call subsystem, the subsystem cannot be exported unless it specifies periodic execution. To specify for this:

- 1 Right-click the Trigger block in the function-call subsystem and choose **Block Parameters** from the context menu.
- 2 Specify **periodic** in the **Sample time type** field.
- 3 Set the **Sample time** to the same granularity specified (directly or by inheritance) in the function-call initiator.
- 4 Click **OK** or **Apply**.

Function-Call Subsystem Export

This example shows a virtual subsystem that contains two function-call subsystems, and the associated code that implements the virtual subsystem. The first figure shows the top level of a model that uses a Stateflow chart named Chart to input two function-call trigger signals (denoted by dash-dot lines) to a virtual subsystem named Subsystem.

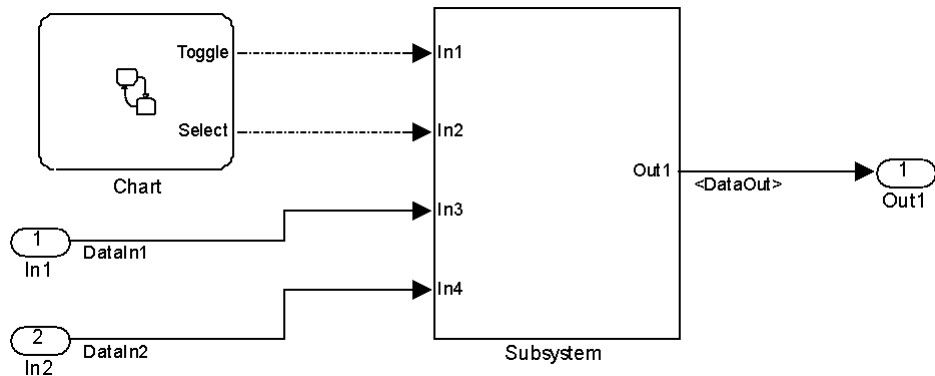

The next figure shows the contents of Subsystem in the previous figure. The subsystem contains two function-call subsystems, each driven by one of the signals input from the top level.

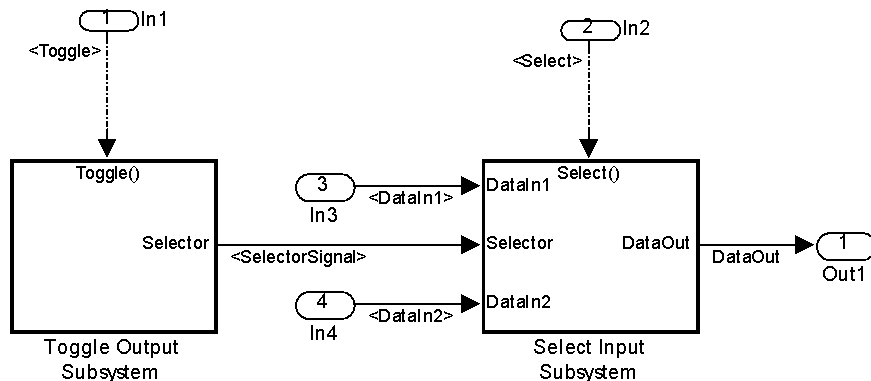

In the preceding model, the Stateflow chart can assert either of two scalar signals, Toggle and Select.

- Asserting `Toggle` toggles the Boolean state of the function-call subsystem `Toggle Output Subsystem`.
- Asserting `Select` causes the function-call subsystem `Select Input Subsystem` to assign the value of `DataIn1` or `DataIn2` to its output signal. The value assigned depends on the current state of `Toggle Output Subsystem`.

The following generated code implements the subsystem named `Subsystem`. The code is typical for virtual subsystems that contain function-call subsystems. It specifies an initialization function and a function for each contained subsystem, and would also include functions to enable and disable subsystems if applicable.

```
#include "Subsystem.h"
#include "Subsystem_private.h"

/* Exported block signals */
real_T DataIn1;           /* '<Root>/In3' */
real_T DataIn2;          /* '<Root>/In4' */
real_T DataOut;          /* '<S4>/Switch' */
boolean_T SelectorSignal; /* '<S5>/Logical Operator' */

/* Exported block states */
boolean_T SelectorState; /* '<S5>/Unit Delay' */

/* Real-time model */
RT_MODEL_Subsystem Subsystem_M_;
RT_MODEL_Subsystem *Subsystem_M = &Subsystem_M_;

/* Initial conditions for exported function: Toggle */

void Toggle_Init(void)
{
    /* Initial conditions for function-call system: '<S1>/Toggle Output Subsystem' */

    /* InitializeConditions for UnitDelay: '<S5>/Unit Delay' */
    SelectorState = Subsystem_P.UnitDelay_X0;
}

/* Output and update for exported function: Toggle */
```

```
void Toggle(void)
{
    /* Output and update for function-call system: '<S1>/Toggle Output Subsystem' */

    /* Logic: '<S5>/Logical Operator' incorporates:
     * UnitDelay: '<S5>/Unit Delay'
     */
    SelectorSignal = !SelectorState;

    /* Update for UnitDelay: '<S5>/Unit Delay' */
    SelectorState = SelectorSignal;
}

/* Output and update for exported function: Select */

void Select(void)
{
    /* Output and update for function-call system: '<S1>/Select Input Subsystem' */

    /* Switch: '<S4>/Switch' incorporates:
     * Inport: '<Root>/In3'
     * Inport: '<Root>/In4'
     */
    if(SelectorSignal) {
        DataOut = DataIn1;
    } else {
        DataOut = DataIn2;
    }
}

/* Model initialize function */

void Subsystem_initialize(void)
{
    /* initialize error status */
    rtmSetErrorStatus(Subsystem_M, (const char_T *)0);

    /* block I/O */
}
```

```
/* exported global signals */
DataOut = 0.0;
SelectorSignal = FALSE;

/* states (dwork) */

/* exported global states */
SelectorState = FALSE;

/* external inputs */
DataIn1 = 0.0;
DataIn2 = 0.0;

Toggle_Init();
}

/* Model terminate function */

void Subsystem_terminate(void)
{
    /* (no terminate code required) */
}
```

Function-Call Subsystems Export Limitations

The function-call subsystem export capabilities have the following limitations:

- Subsystem block parameters do not control the names of the files containing the generated code. All such filenames begin with the name of the exported subsystem. Each filename is suffixed to the file.
- Subsystem block parameters do not control the names of top-level functions in the generated code. Each function name reflects the name of the signal that triggers the function, or for an unnamed signal, the block from which the signal originates.
- The software cannot export reusable code for a function-call subsystem. The parameter **Configuration Parameters > Code Generation > Interface > Generate reusable code** does not apply for a function-call subsystem.
- The function-call subsystem export capability does not support the target language C++ (Encapsulated).

- The software supports code generation for a SIL block provided the block does not have function-call input ports. However, the block will appear as a noninlined S-function in the generated code.
- The software supports a SIL block in accelerator mode only if its function-call initiator is noninlined in accelerator mode. Examples of noninlined initiators include Stateflow charts.
- The SIL block must be driven by a Level-2 S-function initiator block, such as a Stateflow chart or the built-in Function-call Generator block.
- An asynchronous (sample-time) function-call system can be exported, but the software does not support the ERT S-function wrapper for an asynchronous system.
- The software does not support code generation for a SIL block if the block is generated for exported function calls.
- The output from a SIL block cannot be merged using the Merge block.
- The software does not support MAT-file logging for exported function calls. Specifications that enable MAT-file logging is ignored.
- The use of the TLC function `LibIsFirstInit` is deprecated for exported function calls.

Control Generation of Function Prototypes

The Embedded Coder software provides a **Configure Model Functions** button, located on the **Code Generation > Interface** pane of the Configuration Parameters dialog box, that allows you to control the model function prototypes that are generated for ERT-based Simulink models.

By default, the function prototype of an ERT-based model's generated *model_step* function resembles the following:

```
void model_step(void);
```

The function prototype of an ERT-based model's generated *model_initialize* function resembles the following:

```
void model_initialize(void);
```

(For more detailed information about the default calling interface for the *model_step* function, see the *model_step* reference page.)

The **Configure Model Functions** button on the **Interface** pane provides you flexible control over the model function prototypes that are generated for your model. Clicking **Configure Model Functions** launches a Model Interface dialog box. Based on the **Function specification** value you specify for your model function (supported values include **Default model initialize and step functions** and **Model specific C prototypes**), you can preview and modify the function prototypes. Once you validate and apply your changes, you can generate code based on your function prototype modifications.

For more information about using the **Configure Model Functions** button and the Model Interface dialog box, see “Sample Procedure for Configuring Function Prototypes” on page 12-11 and the example model *rtwdemo_fcnprotoctrl*, which is preconfigured to demonstrate function prototype control.

Alternatively, you can use function prototype control functions to programmatically control model function prototypes. For more information, see “Configure Function Prototypes Programmatically” on page 12-16 “Configure Function Prototypes Programmatically” on page 12-16.

You can also control model function prototypes for nonvirtual subsystems, if you generate subsystem code using right-click build. To launch the **Model Interface for subsystem** dialog box, use the `RTW.configSubsystemBuild` function.

Right-click building the subsystem generates the step and initialization functions according to the customizations you make. For more information, see “Configure Function Prototypes for Nonvirtual Subsystems” on page 12-8.

For limitations that apply, see “Function Prototype Control Limitations” on page 12-21.

C++ Encapsulation Interface Control

Using the **Language** option, C++ (Encapsulated), on the **Code Generation** pane of the Configuration Parameters dialog box, you can generate a C++ class interface to model code. The generated interface encapsulates required model data into C++ class attributes and model entry point functions into C++ class methods. The benefits of encapsulation include:

- Greater control over access to model data
- Ability to multiply instantiate model classes
- Easier integration of model code into C++ programming environments

C++ encapsulation also works for right-click builds of nonvirtual subsystems. (For information on requirements that apply, see “Configure C++ Encapsulation Interfaces for Nonvirtual Subsystems” on page 12-41.)

The general procedure for generating C++ encapsulation interfaces to model code is as follows:

- 1** Configure your model to use an `ert.tlc` system target file provided by MathWorks.
- 2** Select the language option C++ (Encapsulated) for your model.
- 3** Optionally, configure related C++ encapsulation interface settings for your model code, using either a graphical user interface (GUI) or application programming interface (API).
- 4** Generate model code and examine the results.

To get started with an example, see “Simple Use of C++ Encapsulation Control” on page 12-25. For more details about configuring C++ encapsulation interfaces for your model code, see *Generating and Configuring C++ Encapsulation Interfaces to Model Code* and “Configure C++ Encapsulation Interfaces Programmatically” on page 12-43. For limitations that apply, see “C++ Encapsulation Interface Control Limitations” on page 12-47.

Note For a demonstration of the C++ encapsulation capability, see the example model `rtwdemo_cppencap`.

Code Replacement

- “Introduction to Code Replacement Libraries” on page 23-2
- “Create Code Replacement Tables” on page 23-18
- “Manage CRTs with the Code Replacement Tool” on page 23-168
- “Examine and Validate Code Replacement Tables” on page 23-191
- “Register Code Replacement Libraries” on page 23-203
- “Custom Code Substitution for MATLAB Functions Using Code Replacement Libraries” on page 23-212
- “Replace MATLAB Function with Custom Code” on page 23-213
- “Enable the Code Replacements Report” on page 23-219
- “Viewing Code Replacements in the Generated Code” on page 23-221
- “Replace MATLAB Function Block Code with Custom Code” on page 23-223
- “Code Replacement Library Limitations” on page 23-229

Introduction to Code Replacement Libraries

In this section...

“Overview of Code Replacement Libraries” on page 23-2

“Code Replacement Libraries General Workflow” on page 23-10

“Code Replacement Libraries Quick-Start Example” on page 23-11

Overview of Code Replacement Libraries

The Embedded Coder software provides the code replacement library (CRL) API, which allows you to create and register code replacement tables. When selected for a model, these CRL tables provide the basis for replacing default functions and operators in your model code with target-specific code. The ability to control function and operator replacements potentially allows you to optimize target speed and memory and better integrate model code with external and legacy code.

A *code replacement library* (CRL) is a set of one or more code replacement tables that define the target-specific implementations of functions and operators to be used in generating code for your Simulink model. The code generation software provides default CRLs, described in the following table. You select these CRLs from the **Code replacement library** drop-down list on the **Code Generation > Interface** pane of the Configuration Parameters dialog box.

CRL	Description	Contains Tables...
C89/C90 (ANSI)	Generates calls to the ISO®/IEC 9899:1990 C standard math library for floating-point functions.	ansi_tfl_table_tmw.mat private_intrinsic_tfl_table_tmw.mat rtw_linux_tfl_table_tmw.mat rtw_mac_tfl_table_tmw.mat rtw_windows_tfl_table_tmw.mat rtw_vxworks_tfl_table_tmw.mat
C99 (ISO)	Generates calls to the ISO/IEC 9899:1999 C standard math library.	iso_tfl_table_tmw.mat ansi_tfl_table_tmw.mat private_intrinsic_tfl_table_tmw.mat rtw_linux_tfl_table_tmw.mat rtw_mac_tfl_table_tmw.mat

CRL	Description	Contains Tables...
		rtw_windows_tfl_table_tmw.mat rtw_vxworks_tfl_table_tmw.mat
GNU99 (GNU)	Generates calls to the GNU ⁷ gcc math library, which provides C99 extensions as defined by compiler option <code>-std=gnu99</code> .	gnu_tfl_table_tmw.mat iso_tfl_table_tmw.mat ansi_tfl_table_tmw.mat private_intrinsic_tfl_table_tmw.mat rtw_linux_tfl_table_tmw.mat rtw_mac_tfl_table_tmw.mat rtw_windows_tfl_table_tmw.mat rtw_vxworks_tfl_table_tmw.mat
C++ (ISO)	Generates calls to the ISO/IEC 14882:2003 C++ standard math library.	iso_cpp_tfl_table_tmw.mat private_iso_cpp_tfl_table_tmw.mat iso_tfl_table_tmw.mat ansi_tfl_table_tmw.mat private_intrinsic_tfl_table_tmw.mat rtw_linux_tfl_table_tmw.mat rtw_mac_tfl_table_tmw.mat rtw_windows_tfl_table_tmw.mat rtw_vxworks_tfl_table_tmw.mat

When a CRL contains multiple tables, the order in which they are listed reflects the order in which they are searched. The CRL API allows you to create your own CRLs, made up of your own function tables in combination with one of the default CRLs. For example, you could create a CRL for an embedded processor that combines some special-purpose function customizations with a processor-specific library of function and operator implementations:

7. GNU[®] is a registered trademark of the Free Software Foundation.

MyProcessor (ANSI)	Generates calls to my custom function implementations or a processor-specific library.	<pre>crl_table_sinfcn.m crl_table_myprocessor.m ansi_tfl_table_tmw.mat private_intrinsic_tfl_table_tmw.mat rtw_linux_tfl_table_tmw.mat rtw_mac_tfl_table_tmw.mat rtw_windows_tfl_table_tmw.mat rtw_vxworks_tfl_table_tmw.mat</pre>
-----------------------	--	--

Each CRL code replacement table contains one or more table entries, with each table entry representing a potential replacement for a single function or operator. Each table entry provides a mapping between a *conceptual view* of the function or operator (similar to the Simulink block view of the function or operator) and a *target-specific implementation* of that function or operator.

The conceptual view of a function or operator is represented in a CRL table entry by the following elements, which identify the function or operator entry to the code generation process:

- A function or operator key (a function name such as 'cos' or an operator ID string such as 'RTW_OP_ADD')
- A set of conceptual arguments that observe a Simulink naming scheme ('y1', 'u1', 'u2', ...), along with their I/O types (output or input) and data types
- Other attributes, such as fixed-point saturation and rounding characteristics for operators, to identify the function or operator to the code generation process as exactly as you require for matching purposes

The target-specific implementation of a function or operator is represented in a CRL table entry by the following elements:

- The name of your implementation function (such as 'cos_db1' or 'u8_add_u8_u8')
- A set of implementation arguments that you define (the order of which must correspond to the conceptual arguments), along with their I/O types (output or input) and data types

- Parameters providing the build information for your implementation function, including header file and source file names and paths

Additionally, a CRL table entry includes a priority value (0–100, with 0 as the highest priority), which defines the entry’s priority relative to other entries in the table.

During code generation for your model, when the code generation process encounters a call site for a function or operator, it creates and partially populates a CRL entry object, for the purpose of querying the CRL for a replacement function. The information provided for the CRL query includes the function or operator key and the conceptual argument list. The CRL entry object is then passed to the CRL. If a matching table entry exists in the CRL, a fully-populated CRL entry, including the implementation function name, argument list, and build information, is returned to the call site and used to generate code.

Within the CRL that is selected for your model, the tables that comprise the CRL are searched in the order in which they are listed (by `RTW.viewTFL` or by the CRL’s **Code replacement library** tool tip). Within each table, if multiple matches are found for a CRL entry object, priority level determines the match that is returned. A higher-priority (lower-numbered) entry is used over a similar entry with a lower priority (higher number).

The Embedded Coder software supports the following functions for replacement with custom library functions using CRL tables.

Note Function replacement supports only scalar inputs. (Operation replacement supports nonscalar inputs for some matrix operations.)

Math Functions

Note For detailed support information, see “Map Math Functions to Target-Specific Implementations” on page 23-30.

abs	acos	acosh	asin
-----	------	-------	------

asinh	atan	atan2	atanh
ceil	cos	cosh	exactrSqrt
exp	fix	floor	frexp
hypot	ldexp	ln	log
log10	max	min	mod/fmod
pow	rem	round	rSqrt
saturate	sign	sin	sincos
sinh	sqrt	round	tanh
Memory Utility Functions			
memcmp	memcpy	memset	memset2zero ¹
Nonfinite Support Utility Functions²			
getInf	getMinusInf	getNaN	isInf ³
isNaN ³			
Notes: ¹ Some target processors provide optimized memset functions for use when performing a memory set to zero. The CRL API supports replacing memset to zero functions with more efficient target-specific functions. ² Replacement of nonfinite functions is supported for Simulink code generation (not for Stateflow or MATLAB Coder code generation). ³ Replacement of isInf and isNaN is supported only for complex floating-point inputs.			

The Embedded Coder software also supports the following operations for replacement with custom library functions using CRL tables.

Note Unless otherwise stated, the listed operators are supported for the following input data types:

- single, double, and their complex equivalents
- int8, int16, int32, and their complex equivalents
- uint8, uint16, uint32, and their complex equivalents
- Fixed-point data types
- Mixed data types (different types for different inputs)

Operator	Key	Scalar Inputs	Nonscalar Inputs
Addition (+)	RTW_OP_ADD	Yes	Yes
Subtraction (-)	RTW_OP_MINUS	Yes	Yes
Multiplication (*)	RTW_OP_MUL	Yes	Yes, including the ability to map to Basic Linear Algebra Subroutine (BLAS) multiplication functions
Division (/)	RTW_OP_DIV	Yes	—
Data type conversion (cast)	RTW_OP_CAST	Yes	—
Shift left (<<)	RTW_OP_SL	Yes, for integer and fixed-point data types	—
Shift right (>>)	RTW_OP_SRA (arithmetic) ¹ RTW_OP_SRL (logical)	Yes, for integer and fixed-point data types	—

Operator	Key	Scalar Inputs	Nonscalar Inputs
Element-wise matrix multiplication (\cdot^*)	RTW_OP_ELEM_MUL ²	—	Yes
Matrix right division (/)	RTW_OP_RDIV ³	—	Yes
Matrix left division (\)	RTW_OP_LDIV ³	—	Yes
Matrix inversion (inv)	RTW_OP_INV ³	—	Yes
Complex conjugation	RTW_OP_CONJUGATE	Yes	Yes
Transposition (\cdot')	RTW_OP_TRANS	—	Yes
Hermitian (complex conjugate) transposition (\cdot')	RTW_OP_HERMITIAN	—	Yes
Multiplication with transposition	RTW_OP_TRMUL	—	Yes, including the ability to map to BLAS multiplication functions

Operator	Key	Scalar Inputs	Nonscalar Inputs
Multiplication with Hermitian transposition	RTW_OP_HMMUL	—	Yes, including the ability to map to BLAS multiplication functions

Notes:

¹ CRLs that provide arithmetic shift right implementations should also provide logical shift right implementations, because some arithmetic shift rights are converted to logical shift rights during code generation.

² For scalar multiplication, use RTW_OP_MUL.

³ Matrix division and inversion are supported for Simulink code generation (not for Stateflow or MATLAB Coder code generation).

For multicore target environments, the Embedded Coder software supports the following semaphore and mutex operations for replacement with custom library functions using CRL tables.

Note Semaphore and mutex code replacement is supported for Simulink code generation for data transfer between tasks, and for code generation targets. For more information, see “Map Semaphore or Mutex Operations to Target-Specific Implementations” on page 23-152.

Operation	Key
Mutex Destroy	RTW_MUTEX_DESTROY
Mutex Init	RTW_MUTEX_INIT
Mutex Lock	RTW_MUTEX_LOCK
Mutex Unlock	RTW_MUTEX_UNLOCK
Semaphore Destroy	RTW_SEM_DESTROY
Semaphore Init	RTW_SEM_INIT
Semaphore Post	RTW_SEM_POST
Semaphore Wait	RTW_SEM_WAIT

Code Replacement Libraries General Workflow

The general steps for creating and using a code replacement library are as follows:

- 1 Create one or more CRL tables containing replacement entries for math operators and functions. To create a table, you can use either a MATLAB based API or the Code Replacement Tool graphical interface. (The example `rtwdemo_crl_script` provides example tables that can be used as a starting point for customization.)

Name	Implementation	NumIn	In1Type	In2Type
RTW_OP_ADD	u16_add_SameSlopeZeroBias	2	fixdt(0,16,*)	fixdt
RTW_OP_ADD	s32_add_SameSlopeZeroBias	2	fixdt(1,32,*)	fixdt
RTW_OP_DIV	s16_div_s16_s16_slopebias	2	fixdt(1,16,15,2)	fixdt
RTW_OP_DIV	s32_div_s16_s16_binarypoint	2	fixdt(1,16,15)	fixdt
RTW_OP_DIV	s16_div_s16_s16_rsf0p125	2	fixdt(1,16,*)	fixdt
RTW_OP_MINUS	s8_sub_SameSlopeZeroBias	2	fixdt(1,8,*)	fixdt
RTW_OP_MUL	s32_mul_s16_s16_binarypoint	2	fixdt(1,16,15)	fixdt
RTW_OP_MUL	s16_mul_s16_s16_rsf0p125	2	fixdt(1,16,*)	fixdt

RTW_OP_MUL	
General Information	Fixed-point Settings
Summary	
Description:	
Key:	RTW_OP_MUL with 2 input(s)
Implementation:	s16_mul_s16_s16_rsf0p125 () with 2 input(s)
Implementation type:	FCN_IMPL_FUNCT
Saturation mode:	RTW_WRAP_ON_OVERFLOW
Rounding modes:	RTW_ROUND_SIMPLEST
GenCallback file:	
Implementation header:	s16_mul_s16_s16_rsf0p125.h
Implementation source:	s16_mul_s16_s16_rsf0p125.c
Priority:	90
Total Usage Count:	0
Entry class:	RTW.TrfCOperationEntryGenerator

- 2 Register a code replacement library, consisting of one or more replacement tables, for use with Simulink or MATLAB Coder software. To register a library, you can use either a MATLAB based API or the Code Replacement Tool graphical interface.
- 3 For Simulink code generation, open your model and select the desired code replacement library from the **Code replacement library** drop-down list located on the **Code Generation > Interface** pane of the Configuration Parameters dialog box.

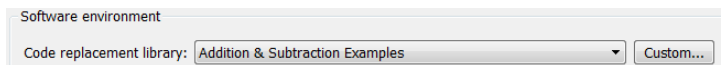

For MATLAB Coder applications, instantiate a Simulink Coder configuration object, set the code replacement library, and provide the configuration object in a call to the codegen function, as follows:

```
cfg = coder.config('lib','ecoder',true);
```



```
cfg.CodeReplacementLibrary = 'Addition & Subtraction Examples';
codegen -config cfg addsub_tow_int16 -args {t,t};
```

4 Build your Simulink model or MATLAB Coder application.

See the example `rtwdemo_crl_script`, which illustrates how to use CRLs to replace operators and functions in generated code. With each model included in this example, a separate CRL is provided to illustrate the creation of operator and function replacements and how to register the replacements with Simulink or MATLAB Coder software.

Code Replacement Libraries Quick-Start Example

This section steps you through a simple example of the complete CRL workflow. (The materials for this example can easily be created based on the file and model displays in this section.)

Note This example uses MATLAB based APIs to create a CRL table and register a CRL. You can perform the same steps using the Code Replacement Tool graphical interface. For more information, see “Manage CRTs with the Code Replacement Tool” on page 23-168.

- 1 Create and save a CRL table definition file that instantiates and populates a CRL table entry, such as the file `crl_table_sinfcn.m` shown below. This file creates function table entries for the `sin` function. For detailed information on creating table definition files for functions and operators, see “Create Code Replacement Tables” on page 23-18.

```
function hTable = crl_table_sinfcn()
%CRL_TABLE_SINFCN - Describe function entries for a Code Replacement Library table.

hTable = RTW.Tf1Table;

% Create entry for double data type sine function replacement
hTable.registerCFunctionEntry(100, 1, 'sin', 'double', 'sin_dbl', ...
                              'double', 'sin_dbl.h','','');

% Create entry for single data type sine function replacement
```

```
hTable.registerCFunctionEntry(100, 1, 'sin', 'single', 'sin_sgl', ...  
                                'double', 'sin_sgl.h', '', '');
```

Note See “Map Math Functions to Target-Specific Implementations” on page 23-30 for another example of `sin` function replacement, in which function arguments are created individually.

- 2** As a first check of the validity of your table entries, invoke the CRL table definition file as follows:

```
>> tbl = crl_table_sinfcn  
tbl =  
RTW.Tf1Table handle  
Package: RTW  
  
Properties:  
    Version: '1.0'  
    ReservedSymbols: []  
    StringResolutionMap: []  
    AllEntries: [2x1 RTW.Tf1CFunctionEntry]  
    EnableTrace: 1  
Methods, Events, Superclasses  
>>
```

Errors found during the invocation are displayed.

- 3** As a further check of your table entries, invoke the Code Replacement Viewer using the following MATLAB command:

```
>> RTW.viewTf1(crl_table_sinfcn)
```

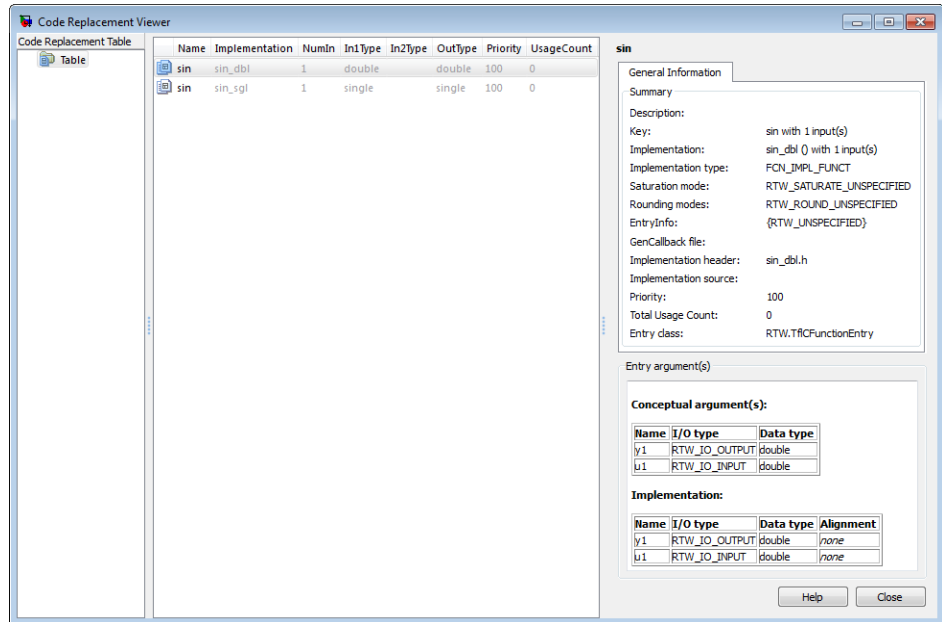

Select entries in your table and verify that the graphical display of the contents of your table meets your expectations. (The Code Replacement Viewer can also help you debug issues with the order of entries in a table, the order of tables in a CRL, and function signature mismatches. For more information, see “Examine and Validate Code Replacement Tables” on page 23-191.)

- 4 Create and save a CRL registration file that includes the `cr1_table_sincfn` table, such as the `s1_customization.m` file shown below. The file specifies that the CRL to be registered is named 'Sine Function Example' and consists of `cr1_table_sincfn`, with the default ANSI⁸ math library as the base CRL table.

```
function s1_customization(cm)
% s1_customization function to register a code replacement library (CRL)

% Register the CRL defined in local function locCrlRegFcn
cm.registerTargetInfo(@locCrlRegFcn);
```

8. ANSI[®] is a registered trademark of the American National Standards Institute, Inc.

```
end % End of SL_CUSTOMIZATION

% Local function to define a CRL containing crl_table_sinfcn
function thisCrl = locCrlRegFcn

    % Instantiate a CRL registry entry
    thisCrl = RTW.Tf1Registry;

    % Define the CRL properties
    thisCrl.Name = 'Sine Function Example';
    thisCrl.Description = 'Example of sine function replacement';
    thisCrl.TableList = {'crl_table_sinfcn'};
    thisCrl.BaseTf1 = 'C89/C90 (ANSI)';
    thisCrl.TargetHWDDeviceType = {'*'};

end % End of LOCCRLREGFCN
```

If you place this `s1_customization.m` file in the MATLAB search path or in the current working folder, the CRL is registered at each Simulink startup.

Tip To refresh Simulink customizations within the current MATLAB session, use the command `s1_refresh_customizations`. To refresh MATLAB Coder CRL registration information within a MATLAB session, use the command `RTW.TargetRegistry.getInstance('reset');`.

For more information about registering CRLs with Simulink or MATLAB Coder software, see “Register Code Replacement Libraries” on page 23-203.

- 5 With your `s1_customization.m` file in the MATLAB search path or in the current working folder, open an ERT-based Simulink model and go to the **Code Generation > Interface** pane of the Configuration Parameters dialog box. Verify that the **Code replacement library** option lists the CRL name you specified and select it.

Note If you hover over the selected library with the cursor, a tool tip appears. This tip contains information derived from your CRL registration file, such as the CRL description and the list of tables it contains.

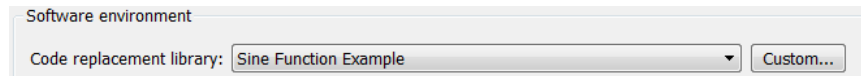

Optionally, you can relaunch the Code Replacement Viewer, using the command `RTW.viewTFL` without arguments, to examine currently registered CRLs, including Sine Function Example.

- 6 Create an ERT-based model with a Trigonometric Function block set to the sine function, for example:

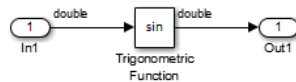

Check that the CRL you registered, Sine Function Example, is selected for this model.

- 7 Go to the **Code Generation > Report** pane of the Configuration Parameters dialog box and select the options **Create code generation report** and **Model-to-code**. Then go to the **Code Generation** pane, select the **Generate code only** option, and generate code for the model.
- 8 Go to Simulink Editor and use model-to-code highlighting to trace the code generated using your CRL entry. For example, right-click the Trigonometric Function block and select **C/C++ Code > Navigate to C/C++ Code**. This selection highlights the `sin` function code within the model step function in `sinefcn.c`. In this case, `sin` has been replaced with `sin_dbl` in the generated code.

```

21
22 /* Real-time model */
23 RT_MODEL_sinefcn sinefcn_M;
24 RT_MODEL_sinefcn *sinefcn_M = &sinefcn_M;
25
26 /* Model step function */
27 void sinefcn_step(void)
28 {
29     /* Outport: '<Root>/Out1' incorporates:
30      * Inport: '<Root>/In1'
31      * Trigonometry: '<Root>/Trigonometric Function'
32      */
33     sinefcn_Y.Out1 = sin_dbl(sinefcn_U.In1);
34 }
35
36 /* Model initialize function */
37 void sinefcn_initialize(void)
38 {
39     /* Registration code */

```

- 9 If functions were not replaced as you intended, you can use the techniques described in “Examine and Validate Code Replacement Tables” on page 23-191 to help you determine why the code generation process was unable to match a function signature with the CRL table entry you created for it.

For example, you can view the CRL cache hits and misses logged during the most recent build. For the code generation step in this example, there was one cache hit and zero cache misses, as shown in the following HitCache and MissCache entries:

```

>> a=get_param('sinefcn','TargetFcnLibHandle')
a =
RTW.Tf1Control
    Version: '1.0'
    HitCache: [1x1 RTW.Tf1CFunctionEntry]
    MissCache: []
    TLCCallList: [0x1 handle]
    Tf1Tables: [9x1 RTW.Tf1Table]
    TargetHWWordLengths: '8,16,32,32'
    SupportNonFinite: 1
    TLCSupported: 1
    Recording: 0
    LoadedLibrary: 'Sine Function Example'
    TargetCharacteristics: [1x1 RTW.TargetCharacteristics]
>> a.HitCache(1)

```

```
ans =  
  RTW.Tf1CFunctionEntry handle  
  Package: RTW  
  
  Properties:  
  .  
  .  
  .  
      Key: 'sin'  
      Priority: 100  
      ConceptualArgs: [2x1 RTW.Tf1ArgNumeric]  
      Implementation: [1x1 RTW.CImplementation]  
  .  
  .  
  .  
>>
```

Create Code Replacement Tables

In this section...

“Overview of Code Replacement Table Creation” on page 23-18

“Create Table Entries” on page 23-22

“Map Math Functions to Target-Specific Implementations” on page 23-30

“Map memcpy Function to Target-Specific Implementations” on page 23-37

“Map Nonfinite Utility Functions to Target-Specific Implementations” on page 23-42

“Map Scalar Operators to Target-Specific Implementations” on page 23-47

“Map Nonscalar Operators to Target-Specific Implementations” on page 23-52

“Map Fixed-Point Operators to Target-Specific Implementations” on page 23-82

“Remap Operator Outputs to Implementation Function Inputs” on page 23-118

“Configure Data Alignment for Function Implementations” on page 23-120

“Refine Matching and Replacement Using Custom Entries” on page 23-133

“Replace Math Functions Based on Computation Method” on page 23-150

“Map Semaphore or Mutex Operations to Target-Specific Implementations” on page 23-152

“Specify Build Information for Code Replacements” on page 23-161

“Add Code Replacement Library Reserved Identifiers” on page 23-165

Overview of Code Replacement Table Creation

To create a CRL table containing replacement information for supported functions and operators, you perform the following steps.

Note This procedure uses MATLAB based APIs to create a CRL table. You can perform the same steps using the Code Replacement Tool graphical interface. For more information, see “Manage CRTs with the Code Replacement Tool” on page 23-168.

- 1** Create a table definition file containing a function definition in the following general form:

```
function hTable = crl_table_name()
%CRL_TABLE_NAME - Describe entries for a Code Replacement Library table.
.
.
.
```

For example, the following sample function definition is from the “Code Replacement Libraries Quick-Start Example” on page 23-11:

```
function hTable = crl_table_sinfcn()
%CRL_TABLE_SINFCN - Describe function entries for a Code Replacement Library table.
.
.
.
```

- 2** Within the function body, instantiate a CRL table with a command such as the following:

```
hTable = RTW.Tf1Table;
```

- 3** Use the CRL table creation functions (listed in the table below) to add table entries representing your replacements for supported functions and operators. For each individual function or operator entry, you issue one or more function calls to
 - a** Instantiate a table entry.
 - b** Add conceptual arguments, implementation arguments, and other attributes to the entry.
 - c** Add the entry to the table.

“Create Table Entries” on page 23-22 describes this procedure in detail, including two methods for creating function entries. The following sample function entry is from the “Code Replacement Libraries Quick-Start Example” on page 23-11:

```
% Create entry for double data type sine function replacement
hTable.registerCFunctionEntry(100, 1, 'sin', 'double', 'sin_dbl', ...
                              'double', 'sin_dbl.h', '', '');
```

- 4** Save the table definition file using the name of the table definition function, for example, `crl_table_sinfcn.m`.

After you have created a table definition file, you can do the following:

- Examine and validate the table, as described in “Examine and Validate Code Replacement Tables” on page 23-191.
- Register a CRL containing the table with the Simulink software, as described in “Register Code Replacement Libraries” on page 23-203.

After you register a CRL with the Simulink software, it appears in the Simulink GUI and can be selected for use in building models.

The following table provides a functional grouping of the CRL table creation functions.

Function	Description
Table entry creation	
addEntry	Add table entry to collection of table entries registered in CRL table
copyConceptualArgsToImplementation	Copy conceptual argument specifications to matching implementation arguments for CRL table entry
createAndAddConceptualArg	Create conceptual argument from specified properties and add to conceptual arguments for CRL table entry
createAndAddImplementationArg	Create implementation argument from specified properties and add to implementation arguments for CRL table entry

Function	Description
createAndSetCImplementationReturn	Create implementation return argument from specified properties and add to implementation for CRL table entry
enableCPP	Enable C++ support for function entry in CRL table
setNameSpace	Set name space for C++ function entry in CRL table
setTf1CFunctionEntryParameters	Set specified parameters for function entry in CRL table
setTf1COperationEntryParameters	Set specified parameters for operator entry in CRL table
setTf1CSemaphoreEntryParameters	Set specified parameters for semaphore entry in CRL table
Alternative method for conceptual argument creation	
addConceptualArg	Add conceptual argument to array of conceptual arguments for CRL table entry
addDWorkArg	Add DWork argument for semaphore entry in CRL table
getTf1ArgFromString	Create CRL argument based on specified name and built-in data type
getTf1DWorkFromString	Create CRL DWork argument for semaphore entry based on specified name and data type
Alternative method for function entry creation	
registerCFunctionEntry	Create CRL function entry based on specified parameters and register in CRL table
registerCPPFunctionEntry	Create CRL C++ function entry based on specified parameters and register in CRL table
registerCPromotableMacroEntry	Create CRL promotable macro entry based on specified parameters and register in CRL table (for abs function replacement only)
Build information	
addAdditionalHeaderFile	Add additional header file to array of additional header files for CRL table entry

Function	Description
<code>addAdditionalIncludePath</code>	Add additional include path to array of additional include paths for CRL table entry
<code>addAdditionalLinkObj</code>	Add additional link object to array of additional link objects for CRL table entry
<code>addAdditionalLinkObjPath</code>	Add additional link object path to array of additional link object paths for CRL table entry
<code>addAdditionalSourceFile</code>	Add additional source file to array of additional source files for CRL table entry
<code>addAdditionalSourcePath</code>	Add additional source path to array of additional source paths for CRL table entry
Reserved identifiers	
<code>setReservedIdentifiers</code>	Register specified reserved identifiers to be associated with CRL table

Create Table Entries

- “Overview of Table Entry Creation” on page 23-22
- “Create Function and Operator Entries” on page 23-25
- “Alternative Method for Creating Function Entries” on page 23-29

Overview of Table Entry Creation

You define CRL table entries by issuing CRL table creation function calls inside a table definition file. The function calls must follow a function declaration and a CRL table instantiation, such as the following.

Note This section uses MATLAB based APIs to create a CRL table. You can perform the same steps using the Code Replacement Tool graphical interface. For more information, see “Manage CRTs with the Code Replacement Tool” on page 23-168.

```
function hTable = crl_table_sinfcn()
```

`%CRL_TABLE_SINFCN` - Describe function entries for a Code Replacement Library table.

```
hTable = RTW.Tf1Table;
```

Within the function body, you use the CRL table creation functions to add table entries representing your replacements for supported functions and operators. For each individual function or operator entry, you issue one or more function calls to

- 1** Instantiate a table entry.
- 2** Add conceptual arguments, implementation arguments, and other attributes to the entry.
- 3** Add the entry to the table.

The general method for creating function and operator entries, described in “Create Function and Operator Entries” on page 23-25, uses the functions shown in the following table.

Function	Description
Table entry creation	
<code>addEntry</code>	Add table entry to collection of table entries registered in CRL table
<code>copyConceptualArgsToImplementation</code>	Copy conceptual argument specifications to matching implementation arguments for CRL table entry
<code>createAndAddConceptualArg</code>	Create conceptual argument from specified properties and add to conceptual arguments for CRL table entry
<code>createAndAddImplementationArg</code>	Create implementation argument from specified properties and add to implementation arguments for CRL table entry
<code>createAndSetCImplementationReturn</code>	Create implementation return argument from specified properties and add to implementation for CRL table entry
<code>enableCPP</code>	Enable C++ support for function entry in CRL table
<code>setNameSpace</code>	Set name space for C++ function entry in CRL table

Function	Description
setTf1CFunctionEntryParameters	Set specified parameters for function entry in CRL table
setTf1COperationEntryParameters	Set specified parameters for operator entry in CRL table
setTf1CSemaphoreEntryParameters	Set specified parameters for semaphore entry in CRL table
Alternative method for conceptual argument creation	
addConceptualArg	Add conceptual argument to array of conceptual arguments for CRL table entry
addDWorkArg	Add DWork argument for semaphore entry in CRL table
getTf1ArgFromString	Create CRL argument based on specified name and built-in data type
getTf1DWorkFromString	Create CRL DWork argument for semaphore entry based on specified name and data type

A simpler alternative creation method is available for function entries, with the constraints that input types must be uniform and implementation arguments must use default Simulink naming. The alternative method uses the following functions and is described in “Alternative Method for Creating Function Entries” on page 23-29.

Function	Description
Alternative method for function entry creation	
registerCFunctionEntry	Create CRL function entry based on specified parameters and register in CRL table
registerCPPFunctionEntry	Create CRL C++ function entry based on specified parameters and register in CRL table
registerCPromotableMacroEntry	Create CRL promotable macro entry based on specified parameters and register in CRL table (for abs function replacement only)

Create Function and Operator Entries

The general workflow for creating CRL table entries applies equally to function and operator replacements, and involves the following steps.

Note

- This section uses MATLAB based APIs to create a CRL table. You can perform the same steps using the Code Replacement Tool graphical interface. For more information, see “Manage CRTs with the Code Replacement Tool” on page 23-168.
- You can remap operator outputs to implementation function inputs for operator replacement entries (see “Remap Operator Outputs to Implementation Function Inputs” on page 23-118). However, for function replacement entries, implementation argument order must match the conceptual argument order. Remapping the argument order in a function implementation is not supported.
- For function entries, if your implementations additionally meet the requirements that all input arguments are of the same type and your implementation arguments use default Simulink naming (return argument *y1* and input arguments *un*), you can use a simpler alternative method for creating the entries, as described in “Alternative Method for Creating Function Entries” on page 23-29.

-
- 1 Within the function body of your table definition file, instantiate a CRL table entry for a function or operator, using one of the following lines of code:

<code>fcn_entry = RTW.Tf1CFunctionEntry;</code>	Supports function replacement
<code>fcn_entry = MyCustomFunctionEntry; (where MyCustomFunctionEntry is a class derived from RTW.Tf1CFunctionEntry)</code>	Supports function replacement using custom CRL table entries, described in “Refine Matching and Replacement Using Custom Entries” on page 23-133

<pre>op_entry = RTW.Tf1COperationEntry;</pre>	<p>Supports operator replacement</p>
<pre>op_entry = RTW.Tf1COperationEntry- Generator;</pre>	<p>Provides relative scaling factor (RSF) fixed-point parameters, described in “Map Fixed-Point Operators to Target-Specific Implementations” on page 23-82, that are not available in RTW.Tf1COperationEntry</p>
<pre>op_entry = RTW.Tf1COperationEntry- Generator_NetSlope;</pre>	<p>Provides net slope parameters, described in “Map Fixed-Point Operators to Target-Specific Implementations” on page 23-82, that are not available in RTW.Tf1COperationEntry</p>
<pre>op_entry = RTW.Tf1BlasEntry- Generator;</pre>	<p>Supports replacement of nonscalar operators with MathWorks BLAS functions, described in “Map Nonscalar Operators to Target-Specific Implementations” on page 23-52</p>
<pre>op_entry = RTW.Tf1CBlasEntry- Generator;</pre>	<p>Supports replacement of nonscalar operators with ANSI/ISO C BLAS functions, described in “Map Nonscalar Operators to Target-Specific Implementations” on page 23-52</p>
<pre>op_entry = MyCustomOperationEntry; (where MyCustomOperationEntry is a class derived from RTW.Tf1COperationEntry)</pre>	<p>Supports operator replacement using custom CRL table entries, described in “Refine Matching and Replacement Using Custom Entries” on page 23-133</p>
<pre>sem_entry = RTW.Tf1CSemaphoreEntry;</pre>	<p>Supports semaphore and mutex replacement, described in “Map Semaphore or Mutex Operations to Target-Specific Implementations” on page 23-152</p>

2 Set the table entry parameters, which are passed in parameter/value pairs to one of the following functions:

- `setTf1CFunctionEntryParameters`
- `setTf1COperationEntryParameters`
- `setTf1CSemaphoreEntryParameters`

For example:

```
setTf1CFunctionEntryParameters(fcn_entry, ...
                              'Key',          'sin', ...
                              'Priority',     30, ...
                              'ImplementationName', 'mySin', ...
                              'ImplementationHeaderFile', 'basicMath.h',...
                              'ImplementationSourceFile', 'basicMath.c');
```

For detailed descriptions of the settable function and operator attributes, see the `setTf1CFunctionEntryParameters` and `setTf1COperationEntryParameters` reference pages.

3 Create and add conceptual arguments to the function or operator entry. Output arguments must precede input arguments, and the function signature (including argument naming, order, and attributes) must fulfill the signature match sought by function or operator callers. Conceptual argument names follow the default Simulink naming convention:

- For return argument, `y1`
- For input argument names, `u1`, `u2`, ..., `un`

You can create and add conceptual arguments in either of two ways:

- Call the `createAndAddConceptualArg` function to create the argument and add it to the table entry. For example:

```
createAndAddConceptualArg(fcn_entry, 'RTW.Tf1ArgNumeric', ...
                          'Name',     'y1',...
                          'IOType',   'RTW_IO_OUTPUT',...
                          'DataTypeMode', 'double');
```

- Call the `getTf1ArgFromString` function to create an argument based on a built-in data type, and then call the `addConceptualArg` function to add the argument to the table entry.

Note If you use `getTf1ArgFromString`, the `IOType` property of the created argument defaults to `'RTW_IO_INPUT'`, indicating an input argument. For an output argument, you must change the `IOType` value to `'RTW_IO_OUTPUT'` by directly assigning the argument property, as shown in the following example.

```
arg = getTf1ArgFromString(hTable, 'y1', 'int16');
arg.IOType = 'RTW_IO_OUTPUT';
addConceptualArg(op_entry, arg);
```

- 4 Create and add implementation arguments, representing the signature of your implementation function, to the function or operator entry. The implementation argument order must match the conceptual argument order. You can create and add implementation arguments in either of two ways:

- Call the `copyConceptualArgsToImplementation` function to populate the implementation arguments as copies of the previously created conceptual arguments. For example:

```
copyConceptualArgsToImplementation(fcn_entry);
```

- Call the `createAndSetCImplementationReturn` function to create the implementation return argument and add it to the table entry, and then call the `createAndAddImplementationArg` function to individually create and add each of your implementation arguments. This method allows you to vary argument attributes, including argument naming, as long as conceptual argument order is maintained. For example:

```
createAndSetCImplementationReturn(op_entry, 'RTW.Tf1ArgNumeric', ...
                                   'Name',      'y1', ...
                                   'IOType',     'RTW_IO_OUTPUT', ...
                                   'IsSigned',   true, ...
                                   'WordLength', 32, ...
                                   'FractionLength', 0);
```

```

createAndAddImplementationArg(op_entry, 'RTW.Tf1ArgNumeric',...
                              'Name',      'u1', ...
                              'IOType',    'RTW_IO_INPUT',...
                              'IsSigned',   true,...
                              'WordLength', 32, ...
                              'FractionLength', 0 );

createAndAddImplementationArg(op_entry, 'RTW.Tf1ArgNumeric',...
                              'Name',      'u2', ...
                              'IOType',    'RTW_IO_INPUT',...
                              'IsSigned',   true,...
                              'WordLength', 32, ...
                              'FractionLength', 0 );

```

- 5** Add the function or operator entry to the CRL table using the `addEntry` function. For example:

```
addEntry(hTable, fcn_entry);
```

For complete examples of function entries and operator entries created using the general method, see “Map Math Functions to Target-Specific Implementations” on page 23-30 and “Map Scalar Operators to Target-Specific Implementations” on page 23-47. For syntax examples, see the examples in the CRL table creation function reference pages.

Alternative Method for Creating Function Entries

You can use a simpler alternative method for creating CRL function entries if your function implementation meets the following criteria:

- The implementation argument order matches the conceptual argument order.
- All input arguments are of the same type.
- The return argument name and input argument names follow the default Simulink naming convention:
 - For the return argument, `y1`
 - For input argument names, `u1, u2, ..., un`

The alternative method for creating function entries involves a single step. Call one of the following functions to create and add conceptual and implementation arguments and register the function entry:

- `registerCFunctionEntry`
- `registerCPPFunctionEntry`
- `registerCPromotableMacroEntry` (use only for the `abs` function)

For example:

```
hTable = RTW.Tf1Table;

registerCFunctionEntry(hTable, 100, 1, 'sqrt', 'double', ...
    'sqrt', 'double', '<math.h>', '', '');
```

For detailed descriptions of the function arguments, see the `registerCFunctionEntry`, `registerCPPFunctionEntry`, and `registerCPromotableMacroEntry` reference pages.

Map Math Functions to Target-Specific Implementations

The Embedded Coder software supports the following math functions for replacement with custom library functions using code replacement library (CRL) tables.

Note Function replacement supports only scalar inputs. (Operation replacement supports nonscalar inputs for some matrix operations.)

Math Function	Simulink Support	Stateflow Support	MATLAB functions and MATLAB Coder Support
<code>abs</code> ¹	<ul style="list-style-type: none"> • Floating-point • Integer • Fixed-point 	<ul style="list-style-type: none"> • Floating-point • Integer 	Floating-point
<code>acos</code> ²	Floating-point	Floating-point	Floating-point

Math Function	Simulink Support	Stateflow Support	MATLAB functions and MATLAB Coder Support
acosh ²	Floating-point	Not available (NA)	Not replaceable (NR)
asin ²	Floating-point	Floating-point	Floating-point
asinh ²	Floating-point	NA	NR
atan ²	Floating-point	Floating-point	Floating-point
atan2	Floating-point	Floating-point	Floating-point
atanh ²	Floating-point	NA	NR
ceil	Floating-point	Floating-point	Floating-point
cos ^{2,3}	Floating-point	Floating-point	Floating-point
cosh ²	Floating-point	Floating-point	Floating-point
exactrSqrt	<ul style="list-style-type: none"> • Floating-point • Integer 	NA	NA
exp	Floating-point	Floating-point	Floating-point
fix	Floating-point	NA	Floating-point
floor	Floating-point	Floating-point	Floating-point
frexp	Floating-point	NA	NA
hypot	Floating-point	NA	Floating-point
ldexp	Floating-point	Floating-point	Floating-point
ln	Floating-point	NA	NA
log	Floating-point	Floating-point	Floating-point
log10	Floating-point	Floating-point	Floating-point
max	<ul style="list-style-type: none"> • Floating-point • Integer • Fixed-point 	<ul style="list-style-type: none"> • Floating-point • Integer 	<ul style="list-style-type: none"> • Floating-point • Integer

Math Function	Simulink Support	Stateflow Support	MATLAB functions and MATLAB Coder Support
min	<ul style="list-style-type: none"> • Floating-point • Integer • Fixed-point 	<ul style="list-style-type: none"> • Floating-point • Integer 	<ul style="list-style-type: none"> • Floating-point • Integer
mod/fmod	<ul style="list-style-type: none"> • Floating-point (mod) • Integer (mod) 	Floating-point (fmod)	NR
pow	Floating-point	Floating-point	Floating-point
rem	Floating-point	NA	Floating-point
round	Floating-point	NA	Floating-point
rSqrt	<ul style="list-style-type: none"> • Floating-point • Integer 	NA	NA
saturate	<ul style="list-style-type: none"> • Floating-point • Integer • Fixed-point 	NA	NA
sign	<ul style="list-style-type: none"> • Floating-point • Integer • Fixed-point 	NA	Floating-point
$\sin^{2,3}$	Floating-point	Floating-point	Floating-point
$\operatorname{sincos}^{2,3}$	Floating-point	NA	NA
\sinh^2	Floating-point	Floating-point	Floating-point
sqrt	<ul style="list-style-type: none"> • Floating-point • Integer • Fixed-point 	Floating-point	Floating-point
\tan^2	Floating-point	Floating-point	Floating-point

Math Function	Simulink Support	Stateflow Support	MATLAB functions and MATLAB Coder Support
\tanh^2	Floating-point	Floating-point	Floating-point

Notes:

¹ `abs` is supported for wrap on integer overflow only; the block option **Saturate on integer overflow** must be cleared.

² Complex/real type combinations are supported for `acos`, `acosh`, `asin`, `asinh`, `atan`, `atanh`, `cos`, `cosh`, `sin`, `sincos`, `sinh`, `tan`, and `tanh` for Simulink code generation (not for Stateflow or MATLAB Coder code generation). Combinations include complex input/complex output and real input/complex output.

³ The CORDIC approximation method is supported for `sin`, `cos`, and `sincos` for Simulink code generation (not for Stateflow or MATLAB Coder code generation).

The following example uses the method described in “Create Function and Operator Entries” on page 23-25 to create a CRL table entry for the `sin` function.

Note

- This example uses MATLAB based APIs to create a CRL table and register a CRL. You can perform the same steps using the Code Replacement Tool graphical interface. For more information, see “Manage CRTs with the Code Replacement Tool” on page 23-168.
 - See “Code Replacement Libraries Quick-Start Example” on page 23-11 for another example of `sin` function replacement, in which function arguments are created using the simpler method described in “Alternative Method for Creating Function Entries” on page 23-29.
-

1 Create and save the following CRL table definition file, `cr1_table_sinfcn2.m`. This file defines a CRL table containing a code replacement entry for the `sin` function.

The function body sets selected sine function entry parameters, creates the `y1` and `u1` conceptual arguments individually, and then copies the conceptual arguments to the implementation arguments. Finally the function entry is added to the table.

```
function hTable = crl_table_sinfcn2()
%CRL_TABLE_SINFCN2 - Describe function entry for a Code Replacement Library table.

hTable = RTW.Tf1Table;

% Create entry for sine function replacement
fcn_entry = RTW.Tf1CFunctionEntry;
setTf1CFunctionEntryParameters(fcn_entry, ...
    'Key', 'sin', ...
    'Priority', 30, ...
    'ImplementationName', 'mySin', ...
    'ImplementationHeaderFile', 'basicMath.h',...
    'ImplementationSourceFile', 'basicMath.c');

createAndAddConceptualArg(fcn_entry, 'RTW.Tf1ArgNumeric', ...
    'Name', 'y1',...
    'IOType', 'RTW_IO_OUTPUT',...
    'DataTypeMode', 'double');

createAndAddConceptualArg(fcn_entry, 'RTW.Tf1ArgNumeric', ...
    'Name', 'u1', ...
    'IOType', 'RTW_IO_INPUT',...
    'DataTypeMode', 'double');

copyConceptualArgsToImplementation(fcn_entry);

addEntry(hTable, fcn_entry);
```

- 2** Optionally, perform a quick check of the validity of the function entry by invoking the table definition file at the MATLAB command line (`>> tbl = crl_table_sinfcn2`) and by viewing it in the Code Replacement Viewer (`>> RTW.viewTf1(crl_table_sinfcn2)`). For more information about validating CRL tables, see “Examine and Validate Code Replacement Tables” on page 23-191.

- 3** Create and save the following CRL registration file, which references the `crl_table_sinfcn2` table.

The file specifies that the CRL to be registered is named 'Sine Function Example 2' and consists of `crl_table_sinfcn2`, with the default ANSI⁹ math library as the base CRL table.

```
function sl_customization(cm)
% sl_customization function to register a code replacement library (CRL)

    % Register the CRL defined in local function locCrlRegFcn
    cm.registerTargetInfo(@locCrlRegFcn);

end % End of SL_CUSTOMIZATION

% Local function to define a CRL containing crl_table_sinfcn2
function thisCrl = locCrlRegFcn

    % Instantiate a CRL registry entry
    thisCrl = RTW.TflRegistry;

    % Define the CRL properties
    thisCrl.Name = 'Sine Function Example 2';
    thisCrl.Description = 'Example of sine function replacement';
    thisCrl.TableList = {'crl_table_sinfcn2'};
    thisCrl.BaseTfl = 'C89/C90 (ANSI)';
    thisCrl.TargetHWDeviceType = {'*'};

end % End of LOCCRLREGFCN
```

Place this `sl_customization.m` file in the MATLAB search path or in the current working folder, so that the CRL is registered at each Simulink startup.

9. ANSI[®] is a registered trademark of the American National Standards Institute, Inc.

Tip To refresh Simulink customizations within the current MATLAB session, use the command `sl_refresh_customizations`. To refresh MATLAB Coder CRL registration information within a MATLAB session, use the command `RTW.TargetRegistry.getInstance('reset');`

For more information about registering CRLs with Simulink or MATLAB Coder software, see “Register Code Replacement Libraries” on page 23-203.

- 4 With your `sl_customization.m` file in the MATLAB search path or in the current working folder, open an ERT-based Simulink model and go to the **Code Generation > Interface** pane of the Configuration Parameters dialog box. Verify that the **Code replacement library** option lists the CRL name you specified and select it.

Note If you hover over the selected library with the cursor, a tool tip appears. This tip provides information derived from your CRL registration file, such as the CRL description and the list of tables it contains.

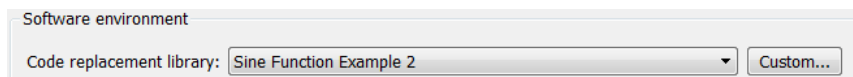

Optionally, you can relaunch the Code Replacement Viewer, using the MATLAB command `RTW.viewTFL` without arguments, to examine the currently registered CRLs, including Sine Function Example 2.

- 5 Create an ERT-based model with a Trigonometric Function block set to the sine function, such as the following:

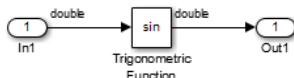

Check that the CRL you registered, Sine Function Example 2, is selected for this model.

- 6 Go to the **Code Generation > Report** pane of the Configuration Parameters dialog box and select the options **Create code generation report** and **Model-to-code**. Then go to the **Code Generation** pane, select the **Generate code only** option, and generate code for the model.
- 7 Go to the Simulink Editor and use model-to-code highlighting to trace the code generated using your CRL entry. For example, right-click the Trigonometric Function block and select **C/C++ Code > Navigate to C/C++ Code**. This selection highlights the sin function code within the model step function in `sinefcn.c`. In this case, `sin` has been replaced with `mySin` in the generated code.

```

21
22 /* Real-time model */
23 RT_MODEL_sinefcn sinefcn_M;
24 RT_MODEL_sinefcn *sinefcn_M = &sinefcn_M;
25
26 /* Model step function */
27 void sinefcn_step(void)
28 {
29     /* Output: '<Root>/Out1' incorporates:
30      * Inport: '<Root>/In1'
31      * Trigonometry: '<Root>/Trigonometric Function'
32      */
33     sinefcn_Y.Out1 = mySin(sinefcn_U.In1);
34 }
35
36 /* Model initialize function */
37 void sinefcn_initialize(void)
38 {
39     /* Registration code */

```

Map memcpy Function to Target-Specific Implementations

The Embedded Coder software supports the following memory utility functions for replacement with custom library functions using code replacement library (CRL) tables.

```

memcpy
memcpy
memset
memset2zero

```

The following example uses the method described in “Create Function and Operator Entries” on page 23-25 to create a CRL table entry for the `memcpy` function.

Note This example uses MATLAB based APIs to create a CRL table and register a CRL. You can perform the same steps using the Code Replacement Tool graphical interface. For more information, see “Manage CRTs with the Code Replacement Tool” on page 23-168.

- 1 Create and save the following CRL table definition file, `cr1_table_memcpy.m`. This file defines a CRL table containing a code replacement entry for the `memcpy` function.

The function body sets selected `memcpy` function entry parameters, creates the `y1`, `u1`, `u2`, and `u3` conceptual arguments individually, adds each argument to the conceptual arguments array for the function, and then copies the conceptual arguments to the implementation arguments. Finally the function entry is added to the table.

```
function hTable = cr1_table_memcpy()
%CRL_TABLE_MEMCPY - Describe memcpy function entry for a CRL table.

hTable = RTW.Tf1Table;

% Create function replacement entry for void* memcpy(void*, void*, size_t)
fcn_entry = RTW.Tf1FunctionEntry;
setTf1FunctionEntryParameters(fcn_entry, ...
                              'Key',          'memcpy', ...
                              'Priority',     90, ...
                              'ImplementationName', 'memcpy_int', ...
                              'ImplementationHeaderFile', 'memcpy_int.h',...
                              'SideEffects',  true);

% Set SideEffects to 'true' for function returning void to prevent it being
% optimized away

arg = getTf1ArgFromString(hTable, 'y1', 'void*');
arg.IOType = 'RTW_IO_OUTPUT';
addConceptualArg(fcn_entry, arg);
```

```

arg = getTf1ArgFromString(hTable, 'u1', 'void*');
addConceptualArg(fcn_entry, arg);

arg = getTf1ArgFromString(hTable, 'u2', 'void*');
addConceptualArg(fcn_entry, arg);

arg = getTf1ArgFromString(hTable, 'u3', 'size_t');
addConceptualArg(fcn_entry, arg);

copyConceptualArgsToImplementation(fcn_entry);
addEntry(hTable, fcn_entry);

```

- 2** Optionally, perform a quick check of the validity of the memcpy entry by invoking the table definition file at the MATLAB command line (>> tbl = crl_table_memcpy) and by viewing it in the Code Replacement Viewer (>> RTW.viewTf1(crl_table_memcpy)). For more information about validating CRL tables, see “Examine and Validate Code Replacement Tables” on page 23-191.
- 3** Create and save the following CRL registration file, which references the crl_table_memcpy table.

The file specifies that the CRL to be registered is named 'Memcpy Function Example' and consists of crl_table_memcpy, with the default ANSI¹⁰ math library as the base CRL table.

```

function sl_customization(cm)
% sl_customization function to register a code replacement library (CRL)

% Register the CRL defined in local function locCrlRegFcn
cm.registerTargetInfo(@locCrlRegFcn);

end % End of SL_CUSTOMIZATION

% Local function to define a CRL containing crl_table_memcpy
function thisCrl = locCrlRegFcn

```

10. ANSI® is a registered trademark of the American National Standards Institute, Inc.

```
% Instantiate a CRL registry entry
thisCrl = RTW.Tf1Registry;

% Define the CRL properties
thisCrl.Name = 'Memcpy Function Example';
thisCrl.Description = 'Example of memcpy function replacement';
thisCrl.TableList = {'crl_table_memcpy'};
thisCrl.BaseTf1 = 'C89/C90 (ANSI)';
thisCrl.TargetHWDDeviceType = {'*'};

end % End of LOCCRLREGFCN
```

Place this `sl_customization.m` file in the MATLAB search path or in the current working folder, so that the CRL is registered at each Simulink startup.

Tip To refresh Simulink customizations within the current MATLAB session, use the command `sl_refresh_customizations`. To refresh MATLAB Coder CRL registration information within a MATLAB session, use the command `RTW.TargetRegistry.getInstance('reset');`

For more information about registering CRLs with Simulink or MATLAB Coder software, see “Register Code Replacement Libraries” on page 23-203.

- 4 With your `sl_customization.m` file in the MATLAB search path or in the current working folder, open an ERT-based Simulink model and go to the **Code Generation > Interface** pane of the Configuration Parameters dialog box. Verify that the **Code replacement library** option lists the CRL name you specified and select it.

Note If you hover over the selected library with the cursor, a tool tip appears. This tip provides information derived from your CRL registration file, such as the CRL description and the list of tables it contains.

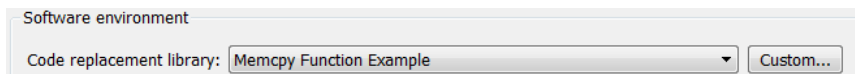

Optionally, you can relaunch the Code Replacement Viewer, using the MATLAB command `RTW.viewTFL` without arguments, to examine the currently registered CRLs, including Memcpy Function Example.

- 5 Create an ERT-based model that uses memcpy for vector assignments. For example,

- a Use In, Out, and Mux blocks to create the following model. (Alternatively, you can open `rtwdemo_crlmath/Subsystem1` and copy the subsystem contents to a new model.)

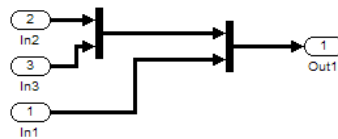

- b Select the diagram and use **Edit > Subsystem** to make it a subsystem.

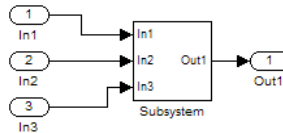

- c Select an ERT-based system target file on the **Code Generation** pane of the Configuration Parameters dialog box, and select the CRL you registered, Memcpy Function Example, on the **Code Generation > Interface** pane. You should also select a fixed-step solver on the **Solver** pane. Leave the memcpy options on the **Optimization > Signals and Parameters** pane at their default settings, that is, **Use memcpy for vector assignment** is selected, and **Memcpy threshold (bytes)** at 64. Apply the changes.
 - d Open Model Explorer and configure the **Signal Attributes** for the In1, In2, and In3 source blocks. For each, set **Port dimensions** to `[1, 100]`, and set **Data type** to `int32`. Apply the changes. Save the model.
- 6 Go to the **Code Generation > Report** pane of the Configuration Parameters dialog box and select the **Create code generation report**. Then go to the **Code Generation** pane, select the **Generate code only** option, and generate code for the model. When code generation completes, the HTML code generation report is displayed.

- 7 In the HTML code generation report, click on the *model.c* section (for example, *memcpyfcn.c*) and inspect the model step function to confirm that *memcpy* has been replaced with *memcpy_int* in the generated code.

```
31 /* Model step function */
32 void memcpyfcn_step(void)
33 {
34     /* Output: '<Root>/Out1' incorporates:
35      * Inport: '<Root>/In1'
36      * Inport: '<Root>/In2'
37      * Inport: '<Root>/In3'
38      */
39     memcpy_int((void *)(&memcpyfcn_Y.Out1[0]), (void *)(&memcpyfcn_U.In2[0]), 100U
40               * sizeof(int32_T));
41     memcpy_int((void *)(&memcpyfcn_Y.Out1[100]), (void *)(&memcpyfcn_U.In3[0]),
42               100U * sizeof(int32_T));
43     memcpy_int((void *)(&memcpyfcn_Y.Out1[200]), (void *)(&memcpyfcn_U.In1[0]),
44               100U * sizeof(int32_T));
45 }
46
47 /* Model initialize function */
48 void memcpyfcn_initialize(void)
49 {
```

Map Nonfinite Utility Functions to Target-Specific Implementations

The Embedded Coder software supports the following nonfinite support utility functions for replacement with custom library functions using code replacement library (CRL) tables.

```
GetInf
GetMinusInf
GetNaN
IsInf
IsNan
```

Note

- Replacement of nonfinite functions is supported for Simulink code generation (not for Stateflow or MATLAB Coder code generation).
 - *IsInf* and *IsNan* are supported only for complex floating-point inputs.
-

The following example uses the method described in “Create Function and Operator Entries” on page 23-25 to create CRL table entries for the nonfinite functions.

- 1 Create and save the following CRL table definition file, `crl_table_nonfinite.m`. This file defines a CRL table containing code replacement entries for three nonfinite functions.

For each function, the function body uses the local function `locAddFcnEnt` to create entries for `single` and `double` replacement. For each entry, the local function sets selected function entry parameters, creates the `y1` and `u1` conceptual arguments individually, and then copies the conceptual arguments to the implementation arguments. Finally the function entry is added to the table.

```
function hTable = crl_table_nonfinite()
%CRL_TABLE_NONFINITE - Describe function entries for a CRL table.

hTable = RTW.Tf1Table;

%% Create entries for nonfinite support utility functions
%locAddFcnEnt(hTable, key,          implName,          out,          in1,          hdr )
locAddFcnEnt(hTable, 'getNaN',      'getNaN',       'double', 'void', 'nonfin.h');
locAddFcnEnt(hTable, 'getNaN',      'getNaNF',      'single', 'void', 'nonfin.h');
locAddFcnEnt(hTable, 'getInf',      'getInf',       'double', 'void', 'nonfin.h');
locAddFcnEnt(hTable, 'getInf',      'getInfF',      'single', 'void', 'nonfin.h');
locAddFcnEnt(hTable, 'getMinusInf', 'getMinusInf',  'double', 'void', 'nonfin.h');
locAddFcnEnt(hTable, 'getMinusInf', 'getMinusInfF', 'single', 'void', 'nonfin.h');

%% Local Function
function locAddFcnEnt(hTable, key, implName, out, in1, hdr)
    if isempty(hTable)
        return;
    end

    fcn_entry = RTW.Tf1CFunctionEntry;
    setTf1CFunctionEntryParameters(fcn_entry, ...
                                    'Key', key, ...
                                    'Priority', 90, ...
                                    'ImplementationName', implName, ...
```

```
                                'ImplementationHeaderFile', hdr);

    arg = getTf1ArgFromString(hTable, 'y1', out);
    arg.IOType = 'RTW_IO_OUTPUT';
    addConceptualArg(fcn_entry, arg);

    arg = getTf1ArgFromString(hTable, 'u1', in1);
    addConceptualArg(fcn_entry, arg);

    copyConceptualArgsToImplementation(fcn_entry);

    addEntry(hTable, fcn_entry);

    %EOF
```

- 2** Optionally, perform a quick check of the validity of the nonfinite function entries by invoking the table definition file at the MATLAB command line (`>> tbl = crl_table_nonfinite`) and by viewing it in the Code Replacement Viewer (`>> RTW.viewTf1(crl_table_nonfinite)`). For more information about validating CRL tables, see “Examine and Validate Code Replacement Tables” on page 23-191.
- 3** Create and save the following CRL registration file, which references the `crl_table_nonfinite` table.

The file specifies that the CRL to be registered is named 'Nonfinite Functions Example' and consists of `crl_table_nonfinite`, with the default ANSI¹¹ math library as the base CRL table.

```
function sl_customization(cm)
% sl_customization function to register a code replacement library (CRL)

% Register the CRL defined in local function locCrlRegFcn
cm.registerTargetInfo(@locCrlRegFcn);

end % End of SL_CUSTOMIZATION

% Local function to define a CRL containing crl_table_nonfinite
```

11. ANSI[®] is a registered trademark of the American National Standards Institute, Inc.

```

function thisCr1 = locCr1RegFcn

    % Instantiate a CRL registry entry
    thisCr1 = RTW.TflRegistry;

    % Define the CRL properties
    thisCr1.Name = 'Nonfinite Functions Example';
    thisCr1.Description = 'Example of nonfinite functions replacement';
    thisCr1.TableList = {'crl_table_nonfinite'};
    thisCr1.BaseTfl = 'C89/C90 (ANSI)';
    thisCr1.TargetHWDDeviceType = {'*'};

end % End of LOCCRLREGFCN

```

Place this `sl_customization.m` file in the MATLAB search path or in the current working folder, so that the CRL is registered at each Simulink startup.

Tip To refresh Simulink customizations within the current MATLAB session, use the command `sl_refresh_customizations`. To refresh MATLAB Coder CRL registration information within a MATLAB session, use the command `RTW.TargetRegistry.getInstance('reset');`.

For more information about registering CRLs with Simulink or MATLAB Coder software, see “Register Code Replacement Libraries” on page 23-203.

- 4 With your `sl_customization.m` file in the MATLAB search path or in the current working folder, open an ERT-based Simulink model and go to the **Code Generation > Interface** pane of the Configuration Parameters dialog box. Verify that the **Code replacement library** option lists the CRL name you specified and select it.

Note If you hover over the selected library with the cursor, a tool tip appears. This tip provides information derived from your CRL registration file, such as the CRL description and the list of tables it contains.

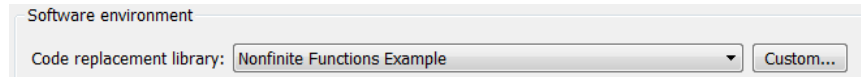

Optionally, you can relaunch the Code Replacement Viewer, using the MATLAB command `RTW.viewTFL` without arguments, to examine the currently registered CRLs, including Nonfinite Functions Example.

- 5 Create an ERT-based model with a Math Function block set to the `rem` function, such as the following:

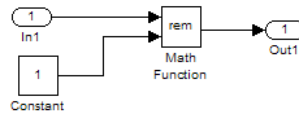

Open Model Explorer. Select the **Support: non-finite numbers** parameter on the **Code Generation > Interface** pane of the Configuration Parameters dialog box and configure the **Signal Attributes** for the `In1` and `Constant` source blocks. For each source block, set **Data type** to `double`. Apply the changes. Save the model.

Check that the CRL you registered, Nonfinite Functions Example, is selected for this model.

- 6 Go to the **Code Generation > Report** pane of the Configuration Parameters dialog box and select the option **Create code generation report**. Then go to the **Code Generation** pane, select the **Generate code only** option, and generate code for the model.
- 7 In the HTML code generation report, click on the `rtnonfinite.c` link and inspect the `rt_InitInfAndNaN` function to confirm that your replacements for nonfinite support functions are present in the generated code.

```

13  /*
14  * Abstract:
15  *   Real-Time Workshop function to initialize non-finites,
16  *   (Inf, NaN and -Inf).
17  */
18  #include "rt_ponfinite.h"
19  #include "nonfin.h"
20  #include "nonfin.h"
21  #define NumBitsPerChar      8
22
23  real_T rtInf;
24  real_T rtMinusInf;
25  real_T rtNaN;
26  real32_T rtInIF;
27  real32_T rtMinusInIF;
28  real32_T rtNaNF;
29
30  /* Function: rt_InitInfAndNaN =====
31  * Abstract:
32  *   Initialize the rtInf, rtMinusInf, and rtNaN needed by the
33  *   generated code. NaN is initialized as non-signaling. Assumes IEEE.
34  */
35  void rt_InitInfAndNaN(size_t realSize)
36  {
37      (void) (realSize);
38      rtNaN = getNaN();
39      rtNaNF = getNaNF();
40      rtInf = getInf();
41      rtInIF = getInIF();
42      rtMinusInf = getMinusInf();
43      rtMinusInIF = getMinusInIF();
44  }

```

Map Scalar Operators to Target-Specific Implementations

The Embedded Coder software supports the following scalar operators for replacement with custom library functions using code replacement library (CRL) tables:

Operator	Key
Addition (+)	RTW_OP_ADD
Subtraction (-)	RTW_OP_MINUS
Multiplication (*)	RTW_OP_MUL
Division (/)	RTW_OP_DIV
Data type conversion (cast)	RTW_OP_CAST
Shift left (<<) [integer and fixed-point data types]	RTW_OP_SL

Operator	Key
Shift right (>>) [integer and fixed-point data types]	RTW_OP_SRA (arithmetic) ¹ RTW_OP_SRL (logical)
Complex conjugation	RTW_OP_CONJUGATE
Notes: ¹ CRLs that provide arithmetic shift right implementations should also provide logical shift right implementations, because some arithmetic shift rights are converted to logical shift rights during code generation.	

Unless otherwise stated, the listed operators are supported for the following input data types:

- single, double, and their complex equivalents
- int8, int16, int32, and their complex equivalents
- uint8, uint16, uint32, and their complex equivalents
- Fixed-point data types
- Mixed data types (different types for different inputs)

The following example uses the method described in “Create Function and Operator Entries” on page 23-25 to create a CRL table entry for the + (addition) operator.

Note This example uses MATLAB based APIs to create a CRL table and register a CRL. You can perform the same steps using the Code Replacement Tool graphical interface. For more information, see “Manage CRTs with the Code Replacement Tool” on page 23-168.

- 1 Create and save the following CRL table definition file, `crl_table_add_uint8.m`. This file defines a CRL table containing an operator replacement entry for the + (addition) operator.

The function body sets selected addition operator entry parameters, creates the y1, u1, and u2 conceptual arguments individually, and then copies

the conceptual arguments to the implementation arguments. Finally, the operator entry is added to the table.

```
function hTable = crl_table_add_uint8
%CRL_TABLE_ADD_UINT8 - Describe operator entry for a Code Replacement Library table.

hTable = RTW.Tf1Table;

% Create entry for addition of built-in uint8 data type
% Saturation on, Rounding unspecified
op_entry = RTW.Tf1COperationEntry;
setTf1COperationEntryParameters(op_entry, ...
    'Key', 'RTW_OP_ADD', ...
    'Priority', 90, ...
    'SaturationMode', 'RTW_SATURATE_ON_OVERFLOW', ...
    'RoundingModes', {'RTW_ROUND_UNSPECIFIED'}, ...
    'ImplementationName', 'u8_add_u8_u8', ...
    'ImplementationHeaderFile', 'u8_add_u8_u8.h', ...
    'ImplementationSourceFile', 'u8_add_u8_u8.c' );

arg = getTf1ArgFromString(hTable, 'y1', 'uint8');
arg.IOType = 'RTW_IO_OUTPUT';
addConceptualArg(op_entry, arg);

arg = getTf1ArgFromString(hTable, 'u1', 'uint8');
addConceptualArg(op_entry, arg );

arg = getTf1ArgFromString(hTable, 'u2', 'uint8');
addConceptualArg(op_entry, arg );

copyConceptualArgsToImplementation(op_entry);

addEntry(hTable, op_entry);
```

- 2** Optionally, perform a quick check of the validity of the operator entry by invoking the table definition file at the MATLAB command line (>> `tbl = crl_table_add_uint8`) and by viewing it in the Code Replacement Viewer (>> `RTW.viewTf1(crl_table_add_uint8)`).

For more information about validating CRL tables, see “Examine and Validate Code Replacement Tables” on page 23-191.

- 3** Create and save the following CRL registration file, which references the `crl_table_add_uint8` table.

The file specifies that the CRL to be registered is named 'Addition Operator Example' and consists of `crl_table_add_uint8`, with the default ANSI math library as the base CRL table.

```
function sl_customization(cm)
% sl_customization function to register a code replacement library (CRL)

% Register the CRL defined in local function locCrlRegFcn
cm.registerTargetInfo(@locCrlRegFcn);

end % End of SL_CUSTOMIZATION

% Local function to define a CRL containing crl_table_add_uint8
function thisCrl = locCrlRegFcn

% Instantiate a CRL registry entry
thisCrl = RTW.Tf1Registry;

% Define the CRL properties
thisCrl.Name = 'Addition Operator Example';
thisCrl.Description = 'Example of addition operator replacement';
thisCrl.TableList = {'crl_table_add_uint8'};
thisCrl.BaseTf1 = 'C89/C90 (ANSI)';
thisCrl.TargetHWDeviceType = {'*'};

end % End of LOCCRLREGFCN
```

Place this `sl_customization.m` file in the MATLAB search path or in the current working folder, so that the CRL is registered at each Simulink startup.

Tip To refresh Simulink customizations within the current MATLAB session, use the command `sl_refresh_customizations`. To refresh MATLAB Coder CRL registration information within a MATLAB session, use the command `RTW.TargetRegistry.getInstance('reset');`

For more information about registering CRLs with Simulink or MATLAB Coder software, see “Register Code Replacement Libraries” on page 23-203.

- 4 With your `sl_customization.m` file in the MATLAB search path or in the current working folder, open an ERT-based Simulink model and go to the **Code Generation > Interface** pane of the Configuration Parameters dialog box. Verify that the **Code replacement library** option lists the CRL name you specified and select it.

Note If you hover over the selected library with the cursor, a tool tip appears. This tip provides information derived from your CRL registration file, such as the CRL description and the list of tables it contains.

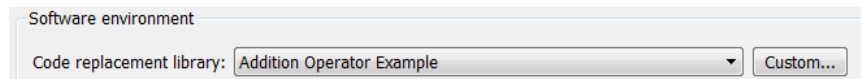

Optionally, you can relaunch the Code Replacement Viewer, using the MATLAB command `RTW.viewTFL` without arguments, to examine The currently registered CRLs, including Addition Operator Example.

- 5 Create an ERT-based model with an Add block, such as the following:

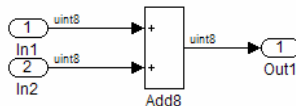

Check that the CRL you registered, Addition Operator Example, is selected for this model.

- 6 Go to the **Code Generation > Report** pane of the Configuration Parameters dialog box and select the options **Create code generation report** and **Model-to-code**. Then go to the **Code Generation** pane, select the **Generate code only** option, and generate code for the model.
- 7 Go to Simulink Editor and use model-to-code highlighting to trace the code generated using your CRL entry. For example, right-click the Add block and select **C/C++ Code > Navigate to C/C++ Code**. This selection highlights the Sum block code within the model step function in `add8.c`. In this case, code containing the `+` operator has been replaced with `u8_add_u8_u8` in the generated code.

```

21
22  /* Real-time model */
23  RT_MODEL_add8 add8_M;
24  RT_MODEL_add8 *add8_M = &add8_M;
25
26  /* Model step function */
27  void add8_step(void)
28  {
29      /* Output: '<Root>/Out1' incorporates:
30       *   Inport: '<Root>/In1'
31       *   Inport: '<Root>/In2'
32       *   Sum: '<Root>/Add8'
33       */
34      add8_Y.Out1 = u8_add_u8_u8(add8_U.In1, add8_U.In2);
35  }
36
37  /* Model initialize function */
38  void add8_initialize(void)
39  {

```

Map Nonscalar Operators to Target-Specific Implementations

- “Map Small Matrix Operations to Intrinsic Functions” on page 23-54
- “Map Matrix Multiplication to MathWorks BLAS Functions” on page 23-60
- “Map Matrix Multiplication to ANSI/ISO C BLAS Functions” on page 23-71

The Embedded Coder software supports the following nonscalar operators for replacement with custom library functions using code replacement library (CRL) tables:

Operator	Key
Addition (+)	RTW_OP_ADD
Subtraction (-)	RTW_OP_MINUS
Multiplication (*)	RTW_OP_MUL
Element-wise matrix multiplication (.*)	RTW_OP_ELEM_MUL ¹
Matrix right division (/)	RTW_OP_RDIV ²
Matrix left division (/)	RTW_OP_LDIV ²
Matrix inversion (inv)	RTW_OP_INV ²
Complex conjugation	RTW_OP_CONJUGATE
Transposition (.')	RTW_OP_TRANS
Hermitian (complex conjugate) transposition (')	RTW_OP_HERMITIAN
Multiplication with transposition	RTW_OP_TRMUL
Multiplication with Hermitian transposition	RTW_OP_HMMUL
Notes:	
¹ For scalar multiplication, use RTW_OP_MUL.	
² Matrix division and inversion are supported for Simulink code generation (not for Stateflow or MATLAB Coder code generation).	

These operators are supported for the following input data types:

- single, double, and their complex equivalents
- int8, int16, int32, and their complex equivalents
- uint8, uint16, uint32, and their complex equivalents
- Fixed-point data types
- Mixed data types (different types for different inputs)

Note Saturation and rounding modes are ignored for floating-point nonscalar addition and subtraction. In CRL table entries for nonscalar addition and subtraction, if the argument data types are all floating-point, the `setTf1COperationEntryParameters` function call should register `'RTW_SATURATE_UNSPECIFIED'` for the `SaturationMode` parameter and `{ 'RTW_ROUND_UNSPECIFIED' }` for the `RoundingModes` parameter.

Map Small Matrix Operations to Intrinsic Functions

You can efficiently implement small matrix operations by invoking processor-specific intrinsic functions. The following example uses the method described in “Create Function and Operator Entries” on page 23-25 to create a CRL table entry mapping small matrix sum operations to implementation functions that could invoke processor-specific intrinsic functions.

Note

- This example uses MATLAB based APIs to create a CRL table and register a CRL. You can perform the same steps using the Code Replacement Tool graphical interface. For more information, see “Manage CRTs with the Code Replacement Tool” on page 23-168.
- For examples of replacing other matrix operations and handling other data types, see the Matrix Operator Replacement section of the CRL examples page `rtwdemo_crl_script`, including the example model `rtwdemo_crlmatops` and its associated files.

-
- 1 Create and save the following CRL table definition file, `crl_table_matrix_add_double.m`. This file defines a CRL table containing two matrix operator replacement entries for the + (addition) operator and the double data type.

The function body sets selected addition operator entry parameters, creates the `y1`, `u1`, and `u2` conceptual arguments individually, and then configures the implementation arguments. Finally, the operator entry is added to the table.

To specify a matrix argument to `createAndAddConceptualArg`, use the CRL argument class `RTW.Tf1ArgMatrix` and specify the base type and the dimensions for which the argument is valid. In this example, the first table entry specifies [2 2] and the second table entry specifies [3 3].

```
function hTable = crl_table_matrix_add_double
%CRL_TABLE_MATRIX_ADD_DOUBLE - Describe two matrix operator entries for a CRL table.

hTable = RTW.Tf1Table;

LibPath = fullfile(matlabroot, 'toolbox', 'rtw', 'rtwdemos', 'crl_demo');

% Create table entry for matrix_sum_2x2_double
op_entry = RTW.Tf1COperationEntry;
setTf1COperationEntryParameters(op_entry, ...
    'Key', 'RTW_OP_ADD', ...
    'Priority', 30, ...
    'SaturationMode', 'RTW_WRAP_ON_OVERFLOW', ...
    'ImplementationName', 'matrix_sum_2x2_double', ...
    'ImplementationHeaderFile', 'MatrixMath.h', ...
    'ImplementationSourceFile', 'MatrixMath.c', ...
    'ImplementationHeaderPath', LibPath, ...
    'ImplementationSourcePath', LibPath, ...
    'AdditionalIncludePaths', {LibPath}, ...
    'GenCallback', 'RTW.copyFileToBuildDir', ...
    'SideEffects', true);

% Specify operands and result
createAndAddConceptualArg(op_entry, 'RTW.Tf1ArgMatrix', ...
    'Name', 'y1', ...
    'IOType', 'RTW_IO_OUTPUT', ...
    'BaseType', 'double', ...
    'DimRange', [2 2]);
createAndAddConceptualArg(op_entry, 'RTW.Tf1ArgMatrix', ...
    'Name', 'u1', ...
    'BaseType', 'double', ...
    'DimRange', [2 2]);
createAndAddConceptualArg(op_entry, 'RTW.Tf1ArgMatrix', ...
    'Name', 'u2', ...
    'BaseType', 'double', ...
```

```

        'DimRange',    [2 2]);

% Specify replacement function signature
arg = getTflArgFromString(hTable, 'y2', 'void');
arg.IOType = 'RTW_IO_OUTPUT';
op_entry.Implementation.setReturn(arg);
arg = getTflArgFromString(hTable, 'u1', ['double' '*'']);
op_entry.Implementation.addArgument(arg);
arg = getTflArgFromString(hTable, 'u2', ['double' '*'']);
op_entry.Implementation.addArgument(arg);
arg = getTflArgFromString(hTable, 'y1', ['double' '*'']);
arg.IOType = 'RTW_IO_OUTPUT';
op_entry.Implementation.addArgument(arg);

addEntry(hTable, op_entry);

% Create table entry for matrix_sum_3x3_double
op_entry = RTW.TflCOperationEntry;
setTflCOperationEntryParameters(op_entry, ...
    'Key',                'RTW_OP_ADD', ...
    'Priority',           30, ...
    'SaturationMode',    'RTW_WRAP_ON_OVERFLOW', ...
    'ImplementationName', 'matrix_sum_3x3_double', ...
    'ImplementationHeaderFile', 'MatrixMath.h', ...
    'ImplementationSourceFile', 'MatrixMath.c', ...
    'ImplementationHeaderPath', LibPath, ...
    'ImplementationSourcePath', LibPath, ...
    'AdditionalIncludePaths', {LibPath}, ...
    'GenCallback',       'RTW.copyFileToBuildDir', ...
    'SideEffects',       true);

% Specify operands and result
createAndAddConceptualArg(op_entry, 'RTW.TflArgMatrix', ...
    'Name',        'y1', ...
    'IOType',      'RTW_IO_OUTPUT', ...
    'BaseType',    'double', ...
    'DimRange',    [3 3]);
createAndAddConceptualArg(op_entry, 'RTW.TflArgMatrix', ...
    'Name',        'u1', ...
    'BaseType',    'double', ...

```

```

        'DimRange',    [3 3]);
createAndAddConceptualArg(op_entry, 'RTW.Tf1ArgMatrix',...
        'Name',        'u2', ...
        'BaseType',    'double', ...
        'DimRange',    [3 3]);

% Specify replacement function signature
arg = getTf1ArgFromString(hTable, 'y2', 'void');
arg.IOType = 'RTW_IO_OUTPUT';
op_entry.Implementation.setReturn(arg);
arg = getTf1ArgFromString(hTable, 'u1', ['double' '*'']);
op_entry.Implementation.addArgument(arg);
arg = getTf1ArgFromString(hTable, 'u2', ['double' '*'']);
op_entry.Implementation.addArgument(arg);
arg = getTf1ArgFromString(hTable, 'y1', ['double' '*'']);
arg.IOType = 'RTW_IO_OUTPUT';
op_entry.Implementation.addArgument(arg);

addEntry(hTable, op_entry);

```

- 2** Optionally, perform a quick check of the validity of the operator entries by invoking the table definition file at the MATLAB command line (>> `tbl = crl_table_matrix_add_double`) and by viewing it in the Code Replacement Viewer (>> `RTW.viewTf1(crl_table_matrix_add_double)`).

For more information about validating CRL tables, see “Examine and Validate Code Replacement Tables” on page 23-191.

- 3** Create and save the following CRL registration file, which references the `crl_table_matrix_add_double` table.

The file specifies that the CRL to be registered is named 'Matrix Addition Operator Example' and consists of `crl_table_matrix_add_double`, with the default ANSI math library as the base CRL table.

```

function sl_customization(cm)
% sl_customization function to register a code replacement library (CRL)

% Register the CRL defined in local function locCrlRegFcn
cm.registerTargetInfo(@locCrlRegFcn);

```

```
end % End of SL_CUSTOMIZATION

% Local function to define a CRL containing crl_table_matrix_add_double
function thisCrl = locCrlRegFcn

    % Instantiate a CRL registry entry
    thisCrl = RTW.TflRegistry;

    % Define the CRL properties
    thisCrl.Name = 'Matrix Addition Operator Example';
    thisCrl.Description = 'Example of matrix addition operator replacement';
    thisCrl.TableList = {'crl_table_matrix_add_double'};
    thisCrl.BaseTfl = 'C89/C90 (ANSI)';
    thisCrl.TargetHWDDeviceType = {'*'};

end % End of LOCCRLREGFCN
```

Place this `sl_customization.m` file in the MATLAB search path or in the current working folder, so that the CRL is registered at each Simulink startup.

Tip To refresh Simulink customizations within the current MATLAB session, use the command `sl_refresh_customizations`. To refresh MATLAB Coder CRL registration information within a MATLAB session, use the command `RTW.TargetRegistry.getInstance('reset');`.

For more information about registering CRLs with Simulink or MATLAB Coder software, see “Register Code Replacement Libraries” on page 23-203.

- 4 With your `sl_customization.m` file in the MATLAB search path or in the current working folder, open an ERT-based Simulink model and go to the **Code Generation > Interface** pane of the Configuration Parameters dialog box. Verify that the **Code replacement library** option lists the CRL name you specified and select it.

Note If you hover over the selected library with the cursor, a tool tip appears. This tip provides information derived from your CRL registration file, such as the CRL description and the list of tables it contains.

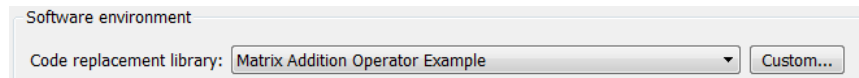

Optionally, you can relaunch the Code Replacement Viewer, using the MATLAB command `RTW.viewTFL` without arguments, to examine the currently registered CRLs, including Matrix Addition Operator Example.

- 5 Create an ERT-based model with an Add block, such as the following:

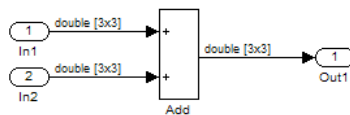

Configure the **Signal Attributes** for the In1 and In2 source blocks. For each source block, set **Port dimensions** to [3 3] and set the **Data type** to **double**. Also, go to the **Solver** pane of the Configuration Parameters dialog box and select a fixed-step, discrete solver with a fixed-step size such as 0.1. Apply the changes. Save the model.

Check that the CRL you registered, Matrix Addition Operator Example, is selected for this model.

- 6 Go to the **Code Generation > Report** pane of the Configuration Parameters dialog box and select the options **Create code generation report** and **Model-to-code**. Then go to the **Code Generation** pane, select the **Generate code only** option, and generate code for the model.
- 7 Go to Simulink Editor and use model-to-code highlighting to trace the code generated using your CRL entry. For example, right-click the Add block and select **C/C++ Code > Navigate to C/C++ Code**. This selection highlights the Sum block code within the model step function in `matrixadd.c`. In this case, code containing the + operator has been replaced with `matrix_sum_3x3_double` in the generated code.

```

26
27 /* Real-time model */
28 RT_MODEL_matrixadd matrixadd_M;
29 RT_MODEL_matrixadd *matrixadd_M = &matrixadd_M;
30
31 /* Model step function */
32 void matrixadd_step(void)
33 {
34 /* Output: '<Root>/Out1' incorporates:
35  * Inport: '<Root>/In1'
36  * Inport: '<Root>/In2'
37  * Sum: '<Root>/Add'
38 */
39 matrix_sum_3x3_double(&matrixadd_U.In1[0], &matrixadd_U.In2[0],
40                      &matrixadd_Y.Out1[0]);
41 }
42
43 /* Model initialize function */
44 void matrixadd_initialize(void)
45 {
46 /* Registration code */
47
48 /* initialize error status */
49 rtmSetErrorStatus(matrixadd_M, (NULL));
50

```

Note Optionally, you can reconfigure the In1 and In2 block **Port dimensions** to [2 2], regenerate code, and observe that code containing the + operator is replaced with `matrix_sum_2x2_double`.

Map Matrix Multiplication to MathWorks BLAS Functions

You can use CRL tables to map nonscalar multiplication operations to the Basic Linear Algebra Subroutine (BLAS) multiplication functions `xgemm` and `xgemv`. The following example uses the method described in “Create Function and Operator Entries” on page 23-25 to create a CRL table entry mapping floating-point matrix/matrix and matrix/vector multiplication operations to MathWorks BLAS library multiplication functions.

Note

- This example uses MATLAB based APIs to create a CRL table and register a CRL. You can perform the same steps using the Code Replacement Tool graphical interface. For more information, see “Manage CRTs with the Code Replacement Tool” on page 23-168.
 - For examples of handling other data types, see the BLAS Support section of the CRL examples page `rtwdemo_crl_script`, including the example model `rtwdemo_crlblas` and its associated files.
-

BLAS libraries support matrix/matrix multiplication in the form of $C = a(\text{op}(A) * \text{op}(B)) + bC$, where $\text{op}(X)$ means X , transposition of X , or Hermitian transposition of X . However, CRLs support only the limited case of $C = \text{op}(A) * \text{op}(B)$ ($a = 1.0$, $b = 0.0$). Correspondingly, although BLAS libraries support matrix/vector multiplication in the form of $y = a(\text{op}(A) * x) + by$, CRLs support only the limited case of $y = \text{op}(A) * x$ ($a = 1.0$, $b = 0.0$).

- 1 Create and save the following CRL table definition file, `crl_table_tmwblas_mmult_double.m`. This file defines a CRL table containing `dgemm` and `dgemv` replacement entries for the matrix multiplication operator and the double data type.

For each entry, the function body sets selected matrix multiplication operator entry parameters, creates the `y1`, `u1`, and `u2` conceptual arguments individually, and then configures special implementation arguments that are required for `dgemm` and `dgemv` replacements. Finally, each operator entry is added to the table.

To specify a matrix argument to `createAndAddConceptualArg`, use the CRL argument class `RTW.Tf1ArgMatrix` and specify the base type and the dimensions for which the argument is valid. This type of table entry supports a range of dimensions specified in the format `[Dim1Min Dim2Min ... DimNMin; Dim1Max Dim2Max ... DimNMax]`. For example, `[2 2; inf inf]` means any two-dimensional matrix of size 2×2 or larger. In this example, the conceptual output argument for the `dgemm32` entry for

matrix/matrix multiplication replacement specifies dimensions [2 2; inf inf], while the conceptual output argument for the `dgemv32` entry for matrix/vector multiplication replacement specifies dimensions [2 1; inf 1].

```
function hTable = cml_table_tmwblas_mmult_double
%CML_TABLE_TMWBLAS_MMULT_DOUBLE - Describe two mmult operator entries for CML table.

hTable = RTW.TflTable;

% Define library path for Windows or UNIX
arch = computer('arch');
if ~ispc
    LibPath = fullfile('$ (MATLAB_ROOT)', 'bin', arch);
else
    % Use Stateflow to get the compiler info
    compilerInfo = sf('Private','compilerman','get_compiler_info');
    compilerName = compilerInfo.compilerName;
    if strcmp(compilerName, 'msvc90') || ...
        strcmp(compilerName, 'msvc80') || ...
        strcmp(compilerName, 'msvc71') || ...
        strcmp(compilerName, 'msvc60'), ...
        compilerName = 'microsoft';
    end
    LibPath = fullfile('$ (MATLAB_ROOT)', 'extern', 'lib', arch, compilerName);
end

% Create table entry for dgemm32
op_entry = RTW.TflBlasEntryGenerator;
if ispc
    libExt = 'lib';
elseif ismac
    libExt = 'dylib';
else
    libExt = 'so';
end
setTflCOperationEntryParameters(op_entry, ...
    'Key',                'RTW_OP_MUL', ...
    'Priority',            100, ...
    'ImplementationName', 'dgemm32', ...
```

```

    'ImplementationHeaderFile', 'blascompat32.h', ...
    'ImplementationHeaderPath', fullfile('${MATLAB_ROOT}','extern','include'), ...
    'AdditionalLinkObjs',      {'libmwblascompat32.' libExt}}, ...
    'AdditionalLinkObjsPaths', {LibPath}, ...
    'SideEffects',            true);

% Specify operands and result
createAndAddConceptualArg(op_entry, 'RTW.Tf1ArgMatrix', ...
    'Name',          'y1', ...
    'IOType',        'RTW_IO_OUTPUT', ...
    'BaseType',      'double', ...
    'DimRange',      [2 2; inf inf]);
createAndAddConceptualArg(op_entry, 'RTW.Tf1ArgMatrix', ...
    'Name',          'u1', ...
    'BaseType',      'double', ...
    'DimRange',      [2 2; inf inf]);
createAndAddConceptualArg(op_entry, 'RTW.Tf1ArgMatrix', ...
    'Name',          'u2', ...
    'BaseType',      'double', ...
    'DimRange',      [1 1; inf inf]);

% Using RTW.Tf1BlasEntryGenerator for xgemm requires the following
% implementation signature:
%
% void f(char* TRANSA, char* TRANSB, int* M, int* N, int* K,
%        type* ALPHA, type* u1, int* LDA, type* u2, int* LDB,
%        type* BETA, type* y, int* LDC)
%
% Upon a match, the CRL entry will compute the
% values for M, N, K, LDA, LDB, and LDC and insert them into the
% generated code. TRANSA and TRANSB both will be set to 'N'.

% Specify replacement function signature

arg = getTf1ArgFromString(hTable, 'y2', 'void');
arg.IOType = 'RTW_IO_OUTPUT';
op_entry.Implementation.setReturn(arg);

arg = RTW.Tf1ArgCharConstant('TRANSA');
% Possible values for PassByType property are

```

```
% RTW_PASSBY_AUTO, RTW_PASSBY_POINTER,
% RTW_PASSBY_VOID_POINTER, RTW_PASSBY_BASE_POINTER
arg.PassByType = 'RTW_PASSBY_POINTER';
op_entry.Implementation.addArgument(arg);

arg = RTW.Tf1ArgCharConstant('TRANSB');
arg.PassByType = 'RTW_PASSBY_POINTER';
op_entry.Implementation.addArgument(arg);

arg = getTf1ArgFromString(hTable, 'M', 'integer', 0);
arg.PassByType = 'RTW_PASSBY_POINTER';
arg.Type.ReadOnly = true;
op_entry.Implementation.addArgument(arg);

arg = getTf1ArgFromString(hTable, 'N', 'integer', 0);
arg.PassByType = 'RTW_PASSBY_POINTER';
arg.Type.ReadOnly = true;
op_entry.Implementation.addArgument(arg);

arg = getTf1ArgFromString(hTable, 'K', 'integer', 0);
arg.PassByType = 'RTW_PASSBY_POINTER';
arg.Type.ReadOnly = true;
op_entry.Implementation.addArgument(arg);

arg = getTf1ArgFromString(hTable, 'ALPHA', 'double', 0);
arg.PassByType = 'RTW_PASSBY_POINTER';
arg.Type.ReadOnly = true;
op_entry.Implementation.addArgument(arg);

arg = getTf1ArgFromString(hTable, 'u1', ['double' '*' ]);
arg.PassByType = 'RTW_PASSBY_POINTER';
arg.Type.ReadOnly = true;
op_entry.Implementation.addArgument(arg);

arg = getTf1ArgFromString(hTable, 'LDA', 'integer', 0);
arg.PassByType = 'RTW_PASSBY_POINTER';
arg.Type.ReadOnly = true;
op_entry.Implementation.addArgument(arg);

arg = getTf1ArgFromString(hTable, 'u2', ['double' '*' ]);
```

```

arg.PassByType = 'RTW_PASSBY_POINTER';
arg.Type.ReadOnly = true;
op_entry.Implementation.addArgument(arg);

arg = getTf1ArgFromString(hTable, 'LDB', 'integer', 0);
arg.PassByType = 'RTW_PASSBY_POINTER';
arg.Type.ReadOnly = true;
op_entry.Implementation.addArgument(arg);

arg = getTf1ArgFromString(hTable, 'BETA', 'double', 0);
arg.PassByType = 'RTW_PASSBY_POINTER';
arg.Type.ReadOnly = true;
op_entry.Implementation.addArgument(arg);

arg = getTf1ArgFromString(hTable, 'y1', ['double' '*'']);
arg.IOType = 'RTW_IO_OUTPUT';
arg.PassByType = 'RTW_PASSBY_POINTER';
op_entry.Implementation.addArgument(arg);

arg = getTf1ArgFromString(hTable, 'LDC', 'integer', 0);
arg.PassByType = 'RTW_PASSBY_POINTER';
arg.Type.ReadOnly = true;
op_entry.Implementation.addArgument(arg);

addEntry(hTable, op_entry);

% Create table entry for dgemv32
op_entry = RTW.Tf1BlasEntryGenerator;
if ispc
    libExt = 'lib';
elseif ismac
    libExt = 'dylib';
else
    libExt = 'so';
end
setTf1COperationEntryParameters(op_entry, ...
    'Key', 'RTW_OP_MUL', ...
    'Priority', 100, ...
    'ImplementationName', 'dgemv32', ...
    'ImplementationHeaderFile', 'blascompat32.h', ...

```

```

    'ImplementationHeaderPath', fullfile('${MATLAB_ROOT}','extern','include'), ...
    'AdditionalLinkObjs',      {'libmwblascompat32.' libExt}}, ...
    'AdditionalLinkObjsPaths', {LibPath},...
    'SideEffects',            true);

% Specify operands and result
createAndAddConceptualArg(op_entry, 'RTW.Tf1ArgMatrix', ...
    'Name',                    'y1', ...
    'IOType',                  'RTW_IO_OUTPUT', ...
    'BaseType',                'double', ...
    'DimRange',                [2 1; inf 1]);
createAndAddConceptualArg(op_entry, 'RTW.Tf1ArgMatrix', ...
    'Name',                    'u1', ...
    'BaseType',                'double', ...
    'DimRange',                [2 2; inf inf]);
createAndAddConceptualArg(op_entry, 'RTW.Tf1ArgMatrix',...
    'Name',                    'u2', ...
    'BaseType',                'double', ...
    'DimRange',                [1 1; inf 1]);

% Using RTW.Tf1BlasEntryGenerator for xgemv requires the following
% implementation signature:
%
% void f(char* TRANS, int* M, int* N,
%         type* ALPHA, type* u1, int* LDA, type* u2, int* INCX,
%         type* BETA, type* y, int* INCY)
%
% Upon a match, the CRL entry will compute the
% values for M, N, LDA, INCX, and INCY, and insert them into the
% generated code. TRANS will be set to 'N'.

% Specify replacement function signature

arg = getTf1ArgFromString(hTable, 'y2', 'void');
arg.IOType = 'RTW_IO_OUTPUT';
op_entry.Implementation.setReturn(arg);

arg = RTW.Tf1ArgCharConstant('TRANS');
arg.PassByType = 'RTW_PASSBY_POINTER';
op_entry.Implementation.addArgument(arg);

```



```
arg = getTf1ArgFromString(hTable, 'M', 'integer', 0);
arg.PassByType = 'RTW_PASSBY_POINTER';
arg.Type.ReadOnly = true;
op_entry.Implementation.addArgument(arg);

arg = getTf1ArgFromString(hTable, 'N', 'integer', 0);
arg.PassByType = 'RTW_PASSBY_POINTER';
arg.Type.ReadOnly = true;
op_entry.Implementation.addArgument(arg);

arg = getTf1ArgFromString(hTable, 'ALPHA', 'double', 0);
arg.PassByType = 'RTW_PASSBY_POINTER';
arg.Type.ReadOnly = true;
op_entry.Implementation.addArgument(arg);

arg = getTf1ArgFromString(hTable, 'u1', ['double' '*']);
arg.PassByType = 'RTW_PASSBY_POINTER';
arg.Type.ReadOnly = true;
op_entry.Implementation.addArgument(arg);

arg = getTf1ArgFromString(hTable, 'LDA', 'integer', 0);
arg.PassByType = 'RTW_PASSBY_POINTER';
arg.Type.ReadOnly = true;
op_entry.Implementation.addArgument(arg);

arg = getTf1ArgFromString(hTable, 'u2', ['double' '*']);
arg.PassByType = 'RTW_PASSBY_POINTER';
arg.Type.ReadOnly = true;
op_entry.Implementation.addArgument(arg);

arg = getTf1ArgFromString(hTable, 'INCX', 'integer', 0);
arg.PassByType = 'RTW_PASSBY_POINTER';
arg.Type.ReadOnly = true;
op_entry.Implementation.addArgument(arg);

arg = getTf1ArgFromString(hTable, 'BETA', 'double', 0);
arg.PassByType = 'RTW_PASSBY_POINTER';
arg.Type.ReadOnly = true;
op_entry.Implementation.addArgument(arg);
```

```

arg = getTf1ArgFromString(hTable, 'y1', ['double' '*' ]);
arg.IOType = 'RTW_IO_OUTPUT';
arg.PassByType = 'RTW_PASSBY_POINTER';
op_entry.Implementation.addArgument(arg);

arg = getTf1ArgFromString(hTable, 'INCY', 'integer', 0);
arg.PassByType = 'RTW_PASSBY_POINTER';
arg.Type.ReadOnly = true;
op_entry.Implementation.addArgument(arg);

addEntry(hTable, op_entry);

```

- 2 Optionally, perform a quick check of the validity of the operator entries by invoking the table definition file at the MATLAB command line (>> `tbl = crl_table_tmwblas_mmult_double`) and by viewing it in the Code Replacement Viewer (>> `RTW.viewTf1(crl_table_tmwblas_mmult_double)`).

For more information about validating CRL tables, see “Examine and Validate Code Replacement Tables” on page 23-191.

- 3 Create and save the following CRL registration file, which references the `crl_table_tmwblas_mmult_double` table.

The file specifies that the CRL to be registered is named 'MathWorks BLAS Matrix Multiplication Operator Example' and consists of `crl_table_tmwblas_mmult_double`, with the default ANSI math library as the base CRL table.

```

function sl_customization(cm)
% sl_customization function to register a code replacement library (CRL)

% Register the CRL defined in local function locCrlRegFcn
cm.registerTargetInfo(@locCrlRegFcn);

end % End of SL_CUSTOMIZATION

% Local function to define a CRL containing crl_table_tmwblas_mmult_double
function thisCrl = locCrlRegFcn

```

```
% Instantiate a CRL registry entry
thisCrl = RTW.Tf1Registry;

% Define the CRL properties
thisCrl.Name = 'MathWorks BLAS Matrix Multiplication Operator Example';
thisCrl.Description = 'Example of MathWorks BLAS mmult operator replacement';
thisCrl.TableList = {'crl_table_tmwblas_mmult_double'};
thisCrl.BaseTf1 = 'C89/C90 (ANSI)';
thisCrl.TargetHWDDeviceType = {'*'};

end % End of LOCCRLREGFCN
```

Place this `sl_customization.m` file in the MATLAB search path or in the current working folder, so that the CRL is registered at each Simulink startup.

Tip To refresh Simulink customizations within the current MATLAB session, use the command `sl_refresh_customizations`. To refresh MATLAB Coder CRL registration information within a MATLAB session, use the command `RTW.TargetRegistry.getInstance('reset');`

For more information about registering CRLs with Simulink or MATLAB Coder software, see “Register Code Replacement Libraries” on page 23-203.

- 4 With your `sl_customization.m` file in the MATLAB search path or in the current working folder, open an ERT-based Simulink model and go to the **Code Generation > Interface** pane of the Configuration Parameters dialog box. Verify that the **Code replacement library** option lists the CRL name you specified and select it.

Note If you hover over the selected library with the cursor, a tool tip appears. This tip provides information derived from your CRL registration file, such as the CRL description and the list of tables it contains.

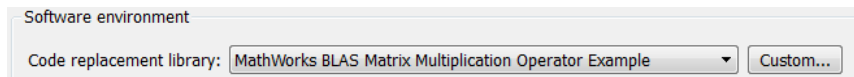

Optionally, you can relaunch the Code Replacement Viewer, using the MATLAB command `RTW.viewTFL` without arguments, to examine the currently registered CRLs, including MathWorks BLAS Matrix Multiplication Operator Example.

- 5 Create an ERT-based model with two Product blocks, such as the following:

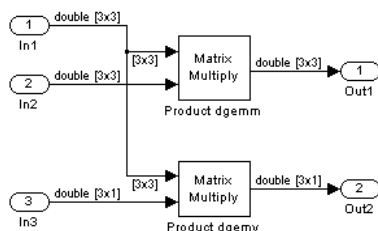

- a For each Product block, set the block parameter **Multiplication** to the value `Matrix(*)`.
 - b Configure the **Signal Attributes** for the In1, In2, and In3 source blocks. For In1 and In2, set **Port dimensions** to [3 3] and set the **Data type** to double. For In3, set **Port dimensions** to [3 1] and set the **Data type** to double.
 - c Also, go to the **Solver** pane of the Configuration Parameters dialog box and select a fixed-step, discrete solver with a fixed-step size such as 0.1. Apply the changes.
 - d Save the model.
 - e Check that the CRL you registered, MathWorks BLAS Matrix Multiplication Operator Example, is selected for this model.
- 6 Go to the **Code Generation > Report** pane of the Configuration Parameters dialog box and select the options **Create code generation report** and **Model-to-code**. Then go to the **Code Generation** pane, select the **Generate code only** option, and generate code for the model.
 - 7 Go to Simulink Editor and use model-to-code highlighting to trace the code generated using your CRL entry. For example, right-click the top Product

block and select **C/C++ Code > Navigate to C/C++ Code**. This selection highlights the Product block code within the model step function in `tmwblas_mmult.c`. In this case, code containing the matrix multiplication operator has been replaced with a call to `dgemm32` in the generated code.

```

45  /* Outport: '<Root>/Out1' incorporates:
46  * Inport: '<Root>/In1'
47  * Inport: '<Root>/In2'
48  * Product: '<Root>/Product dgemm'
49  */
50  TRANSA = 'N';
51  TRANSB = 'N';
52  M = 3;
53  N = 3;
54  K = 3;
55  ALPHA = 1.0;
56  LDA = 3;
57  LDB = 3;
58  BETA = 0.0;
59  LDC = 3;
60  dgemm32(&TRANSA, &TRANSB, &M, &N, &K, &ALPHA, &tmwblas_mmult_U.In1[0], &LDA,
61         &tmwblas_mmult_U.In2[0], &LDB, &BETA, &tmwblas_mmult_Y.Out1[0], &LDC);
62
63  /* Outport: '<Root>/Out2' incorporates:
64  * Inport: '<Root>/In1'
65  * Inport: '<Root>/In3'
66  * Product: '<Root>/Product dgemv'

```

Map Matrix Multiplication to ANSI/ISO C BLAS Functions

You can use CRL tables to map nonscalar multiplication operations to the ANSI/ISO C BLAS multiplication functions `xgemm` and `xgemv`. The following example uses the method described in “Create Function and Operator Entries” on page 23-25 to create a CRL table entry mapping floating-point matrix/matrix and matrix/vector multiplication operations to ANSI/ISO C BLAS library multiplication functions.

Note

- This example uses MATLAB based APIs to create a CRL table and register a CRL. You can perform the same steps using the Code Replacement Tool graphical interface. For more information, see “Manage CRTs with the Code Replacement Tool” on page 23-168.
 - For examples of handling other data types, see the BLAS Support section of the CRL examples page `rtwdemo_cr1_script`, including the example model `rtwdemo_cr1blas` and its associated files.
-

BLAS libraries support matrix/matrix multiplication in the form of $C = a(\text{op}(A) * \text{op}(B)) + bC$, where $\text{op}(X)$ means X , transposition of X , or Hermitian transposition of X . However, CRLs support only the limited case of $C = \text{op}(A) * \text{op}(B)$ ($a = 1.0$, $b = 0.0$). Correspondingly, although BLAS libraries support matrix/vector multiplication in the form of $y = a(\text{op}(A) * x) + by$, CRLs support only the limited case of $y = \text{op}(A) * x$ ($a = 1.0$, $b = 0.0$).

- 1 Create and save the following CRL table definition file, `cr1_table_cblas_mmult_double.m`. This file defines a CRL table containing `dgemm` and `dgemv` replacement entries for the matrix multiplication operator and the double data type.

For each entry, the function body sets selected matrix multiplication operator entry parameters, creates the `y1`, `u1`, and `u2` conceptual arguments individually, and then configures special implementation arguments that are required for `dgemm` and `dgemv` replacements. Finally, each operator entry is added to the table.

To specify a matrix argument to `createAndAddConceptualArg`, use the CRL argument class `RTW.Tf1ArgMatrix` and specify the base type and the dimensions for which the argument is valid. This type of table entry supports a range of dimensions specified in the format `[Dim1Min Dim2Min ... DimNMin; Dim1Max Dim2Max ... DimNMax]`. For example, `[2 2; inf inf]` means any two-dimensional matrix of size 2x2 or larger. In this example, the conceptual output argument for the `cblas_dgemm` entry for

matrix/matrix multiplication replacement specifies dimensions [2 2; inf inf], while the conceptual output argument for the `cblas_dgemv` entry for matrix/vector multiplication replacement specifies dimensions [2 1; inf 1].

```
function hTable = crl_table_cblas_mmult_double
%CRL_TABLE_CBLAS_MMULT_DOUBLE - Describe two mmult operator entries for CRL table.

hTable = RTW.TflTable;

LibPath = fullfile(matlabroot, 'toolbox', 'rtw', 'rtwdemos', 'crl_demo');

% Create table entry for cblas_dgemm
op_entry = RTW.TflCblasEntryGenerator;
setTflCOperationEntryParameters(op_entry, ...
    'Key', 'RTW_OP_MUL', ...
    'Priority', 100, ...
    'ImplementationName', 'cblas_dgemm', ...
    'ImplementationHeaderFile', 'cblas.h', ...
    'ImplementationHeaderPath', LibPath, ...
    'AdditionalIncludePaths', {LibPath}, ...
    'GenCallback', 'RTW.copyFileToBuildDir', ...
    'SideEffects', true);

% Specify operands and result
createAndAddConceptualArg(op_entry, 'RTW.TflArgMatrix', ...
    'Name', 'y1', ...
    'IOType', 'RTW_IO_OUTPUT', ...
    'BaseType', 'double', ...
    'DimRange', [2 2; inf inf]);
createAndAddConceptualArg(op_entry, 'RTW.TflArgMatrix', ...
    'Name', 'u1', ...
    'BaseType', 'double', ...
    'DimRange', [2 2; inf inf]);
createAndAddConceptualArg(op_entry, 'RTW.TflArgMatrix', ...
    'Name', 'u2', ...
    'BaseType', 'double', ...
    'DimRange', [1 1; inf inf]);

% Using RTW.TflCblasEntryGenerator for xgemm requires the following
```

```
% implementation signature:
%
% void f(enum ORDER, enum TRANSA, enum TRANSB, int M, int N, int K,
%       type ALPHA, type* u1, int LDA, type* u2, int LDB,
%       type BETA, type* y, int LDC)
%
% Since CRLs do not have the ability to specify enums, you must
% use integer. (This will cause problems with C++ code generation,
% so for C++, use a wrapper function to cast each int to the
% corresponding enumeration type.)
%
% Upon a match, the CRL entry will compute the
% values for M, N, K, LDA, LDB, and LDC and insert them into the
% generated code.

% Specify replacement function signature

arg = getTf1ArgFromString(hTable, 'y2', 'void');
arg.IOType = 'RTW_IO_OUTPUT';
op_entry.Implementation.setReturn(arg);

arg = getTf1ArgFromString(hTable, 'ORDER', 'integer', 102);
%arg.Type.ReadOnly=true;
op_entry.Implementation.addArgument(arg);

arg = getTf1ArgFromString(hTable, 'TRANSA', 'integer', 111);
%arg.Type.ReadOnly=true;
op_entry.Implementation.addArgument(arg);

arg = getTf1ArgFromString(hTable, 'TRANSB', 'integer', 111);
%arg.Type.ReadOnly=true;
op_entry.Implementation.addArgument(arg);

arg = getTf1ArgFromString(hTable, 'M', 'integer', 0);
op_entry.Implementation.addArgument(arg);

arg = getTf1ArgFromString(hTable, 'N', 'integer', 0);
op_entry.Implementation.addArgument(arg);

arg = getTf1ArgFromString(hTable, 'K', 'integer', 0);
```



```

op_entry.Implementation.addArgument(arg);

arg = getTf1ArgFromString(hTable, 'ALPHA', 'double', 1);
op_entry.Implementation.addArgument(arg);

arg = getTf1ArgFromString(hTable, 'u1', ['double' '*' ]);
op_entry.Implementation.addArgument(arg);

arg = getTf1ArgFromString(hTable, 'LDA', 'integer', 0);
op_entry.Implementation.addArgument(arg);

arg = getTf1ArgFromString(hTable, 'u2', ['double' '*' ]);
op_entry.Implementation.addArgument(arg);

arg = getTf1ArgFromString(hTable, 'LDB', 'integer', 0);
op_entry.Implementation.addArgument(arg);

arg = getTf1ArgFromString(hTable, 'BETA', 'double', 0);
op_entry.Implementation.addArgument(arg);

arg = getTf1ArgFromString(hTable, 'y1', ['double' '*' ]);
arg.IOType = 'RTW_IO_OUTPUT';
op_entry.Implementation.addArgument(arg);

arg = getTf1ArgFromString(hTable, 'LDC', 'integer', 0);
op_entry.Implementation.addArgument(arg);

addEntry(hTable, op_entry);

% Create table entry for cblas_dgemv
op_entry = RTW.Tf1CBlasEntryGenerator;
setTf1COperationEntryParameters(op_entry, ...
    'Key', 'RTW_OP_MUL', ...
    'Priority', 100, ...
    'ImplementationName', 'cblas_dgemv', ...
    'ImplementationHeaderFile', 'cblas.h', ...
    'ImplementationHeaderPath', LibPath, ...
    'AdditionalIncludePaths', {LibPath}, ...
    'GenCallback', 'RTW.copyFileToBuildDir', ...
    'SideEffects', true);

```

```

% Specify operands and result
createAndAddConceptualArg(op_entry, 'RTW.Tf1ArgMatrix', ...
                           'Name',      'y1', ...
                           'IOType',    'RTW_IO_OUTPUT', ...
                           'BaseType',   'double', ...
                           'DimRange',   [2 1; inf 1]);
createAndAddConceptualArg(op_entry, 'RTW.Tf1ArgMatrix', ...
                           'Name',      'u1', ...
                           'BaseType',   'double', ...
                           'DimRange',   [2 2; inf inf]);
createAndAddConceptualArg(op_entry, 'RTW.Tf1ArgMatrix',...
                           'Name',      'u2', ...
                           'BaseType',   'double', ...
                           'DimRange',   [1 1; inf 1]);

% Using RTW.Tf1CBlasEntryGenerator for xgemv requires the following
% implementation signature:
%
% void f(enum ORDER, enum TRANSA, int M, int N,
%        type ALPHA, type* u1, int LDA, type* u2, int INCX,
%        type BETA, type* y, int INCY)
%
% Since CRLs do not have the ability to specify enums, you must
% use integer. (This will cause problems with C++ code generation,
% so for C++, use a wrapper function to cast each int to the
% corresponding enumeration type.)
%
% Upon a match, the CRL entry will compute the
% values for M, N, LDA, INCX, and INCY and insert them into the
% generated code.

% Specify replacement function signature

arg = getTf1ArgFromString(hTable, 'y2', 'void');
arg.IOType = 'RTW_IO_OUTPUT';
op_entry.Implementation.setReturn(arg);

arg = getTf1ArgFromString(hTable, 'ORDER', 'integer', 102);
%arg.Type.ReadOnly=true;

```

```
op_entry.Implementation.addArgument(arg);

arg = getTf1ArgFromString(hTable, 'TRANSA', 'integer', 111);
%arg.Type.ReadOnly=true;
op_entry.Implementation.addArgument(arg);

arg = getTf1ArgFromString(hTable, 'M', 'integer', 0);
op_entry.Implementation.addArgument(arg);

arg = getTf1ArgFromString(hTable, 'N', 'integer', 0);
op_entry.Implementation.addArgument(arg);

arg = getTf1ArgFromString(hTable, 'ALPHA', 'double', 1);
op_entry.Implementation.addArgument(arg);

arg = getTf1ArgFromString(hTable, 'u1', ['double' '*' ]);
op_entry.Implementation.addArgument(arg);

arg = getTf1ArgFromString(hTable, 'LDA', 'integer', 0);
op_entry.Implementation.addArgument(arg);

arg = getTf1ArgFromString(hTable, 'u2', ['double' '*' ]);
op_entry.Implementation.addArgument(arg);

arg = getTf1ArgFromString(hTable, 'INCX', 'integer', 0);
op_entry.Implementation.addArgument(arg);

arg = getTf1ArgFromString(hTable, 'BETA', 'double', 0);
op_entry.Implementation.addArgument(arg);

arg = getTf1ArgFromString(hTable, 'y1', ['double' '*' ]);
arg.IOType = 'RTW_IO_OUTPUT';
op_entry.Implementation.addArgument(arg);

arg = getTf1ArgFromString(hTable, 'INCY', 'integer', 0);
op_entry.Implementation.addArgument(arg);

addEntry(hTable, op_entry);
```

- 2 Optionally, perform a quick check of the validity of the operator entries by invoking the table definition file at the MATLAB command line (`>> tbl = crl_table_cblas_mmult_double`) and by viewing it in the Code Replacement Viewer (`>> RTW.viewTFL(crl_table_cblas_mmult_double)`).

For more information about validating CRL tables, see “Examine and Validate Code Replacement Tables” on page 23-191.

- 3 Create and save the following CRL registration file, which references the `crl_table_cblas_mmult_double` table.

The file specifies that the CRL to be registered is named 'ANSI/ISO C BLAS Matrix Multiplication Operator Example' and consists of `crl_table_cblas_mmult_double`, with the default ANSI math library as the base CRL table.

```
function sl_customization(cm)
% sl_customization function to register a code replacement library (CRL)

% Register the CRL defined in local function locCrlRegFcn
cm.registerTargetInfo(@locCrlRegFcn);

end % End of SL_CUSTOMIZATION

% Local function to define a CRL containing crl_table_cblas_mmult_double
function thisCrl = locCrlRegFcn

% Instantiate a CRL registry entry
thisCrl = RTW.TflRegistry;

% Define the CRL properties
thisCrl.Name = 'ANSI/ISO C BLAS Matrix Multiplication Operator Example';
thisCrl.Description = 'Example of C BLAS mmult operator replacement';
thisCrl.TableList = {'crl_table_cblas_mmult_double'};
thisCrl.BaseTfl = 'C89/C90 (ANSI)';
thisCrl.TargetHWDeviceType = {'*'};

end % End of LOCCRLREGFCN
```

Place this `sl_customization.m` file in the MATLAB search path or in the current working folder, so that the CRL is registered at each Simulink startup.

Tip To refresh Simulink customizations within the current MATLAB session, use the command `sl_refresh_customizations`. To refresh MATLAB Coder CRL registration information within a MATLAB session, use the command `RTW.TargetRegistry.getInstance('reset');`

For more information about registering CRLs with Simulink or MATLAB Coder software, see “Register Code Replacement Libraries” on page 23-203.

- 4 With your `sl_customization.m` file in the MATLAB search path or in the current working folder, open an ERT-based Simulink model and go to the **Code Generation > Interface** pane of the Configuration Parameters dialog box. Verify that the **Code replacement library** option lists the CRL name you specified and select it.

Note If you hover over the selected library with the cursor, a tool tip appears. This tip provides information derived from your CRL registration file, such as the CRL description and the list of tables it contains.

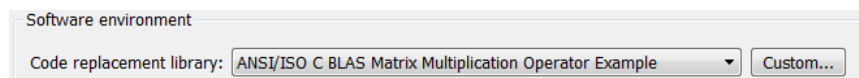

Optionally, you can relaunch the Code Replacement Viewer, using the MATLAB command `RTW.viewTFL` without arguments, to examine the currently registered CRLs, including ANSI/ISO C BLAS Matrix Multiplication Operator Example.

- 5 Create an ERT-based model with two Product blocks, such as the following:

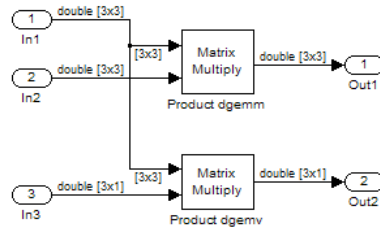

- a For each Product block, set the block parameter **Multiplication** to the value `Matrix(*)`.
 - b Configure the **Signal Attributes** for the In1, In2, and In3 source blocks. For In1 and In2, set **Port dimensions** to [3 3] and set the **Data type** to double. For In3, set **Port dimensions** to [3 1] and set the **Data type** to double.
 - c Also, go to the **Solver** pane of the Configuration Parameters dialog box and select a fixed-step, discrete solver with a fixed-step size such as 0.1. Apply the changes.
 - d Save the model.
 - e Check that the CRL you registered, ANSI/ISO C BLAS Matrix Multiplication Operator Example, is selected for this model.
- 6 Go to the **Code Generation > Report** pane of the Configuration Parameters dialog box and select the options **Create code generation report** and **Model-to-code**. Then go to the **Code Generation** pane, select the **Generate code only** option, and generate code for the model.
 - 7 Go to Simulink Editor and use model-to-code highlighting to trace the code generated using your CRL entry. For example, right-click the top Product block and select **C/C++ Code > Navigate to C/C++ Code**. This selection highlights the Product block code within the model step function in `cblas_mmult.c`. In this case, code containing the matrix multiplication operator has been replaced with a call to `cblas_dgemm` in the generated code.

```
31 /* Model step function */
32 void cblas_mmult_step(void)
33 {
34     /* Outport: '<Root>/Out1' incorporates:
35      * Inport: '<Root>/In1'
36      * Inport: '<Root>/In2'
37      * Product: '<Root>/Product dgemm'
38     */
39     cblas_dgemm(102, 111, 111, 3, 3, 3, 1.0, &cblas_mmult_U.In1[0], 3,
40                &cblas_mmult_U.In2[0], 3, 0.0, &cblas_mmult_Y.Out1[0], 3);
41
42     /* Outport: '<Root>/Out2' incorporates:
43      * Inport: '<Root>/In1'
44      * Inport: '<Root>/In3'
45      * Product: '<Root>/Product dgemv'
46     */
47     cblas_dgemv(102, 111, 3, 3, 1.0, &cblas_mmult_U.In1[0], 3, &cblas_mmult_U.In3
48                [0], 1, 0.0, &cblas_mmult_Y.Out2[0], 1);
49 }
50
51 /* Model initialize function */
52 void cblas_mmult_initialize(void)
53 {
54     /* Registration code */
```

Map Fixed-Point Operators to Target-Specific Implementations

- “Overview of Fixed-Point Operator Replacement” on page 23-82
- “Fixed-Point Numbers and Arithmetic” on page 23-84
- “Create Fixed-Point Operator Entries” on page 23-90
- “Create Fixed-Point Operator Entries for Binary-Point-Only Scaling” on page 23-93
- “Create Fixed-Point Operator Entries for [Slope Bias] Scaling” on page 23-96
- “Create Fixed-Point Operator Entries for Relative Scaling (Multiplication and Division)” on page 23-99
- “Create Fixed-Point Operator Entries for Net Slope (Multiplication and Division)” on page 23-103
- “Create Fixed-Point Operator Entries for Equal Slope and Zero Net Bias (Addition and Subtraction)” on page 23-106
- “Map Data Type Conversion (Cast) Operations to Target-Specific Implementations” on page 23-110
- “Map Fixed-Point Shift Left Operations to Target-Specific Implementations” on page 23-113

Overview of Fixed-Point Operator Replacement

The Embedded Coder software supports CRL-based code replacement for the following scalar operations on fixed-point data types:

Operator	Key
Addition (+)	RTW_OP_ADD
Subtraction (-)	RTW_OP_MINUS
Multiplication (*)	RTW_OP_MUL
Division (/)	RTW_OP_DIV
Data type conversion (cast)	RTW_OP_CAST

Operator	Key
Shift left (<<)	RTW_OP_SL
Shift right (>>)	RTW_OP_SRA (arithmetic) ¹ RTW_OP_SRL (logical)
Notes: ¹ CRLs that provide arithmetic shift right implementations should also provide logical shift right implementations, because some arithmetic shift rights are converted to logical shift rights during code generation.	

Fixed-point operator table entries can be defined as matching:

- A specific binary-point-only scaling combination on the operator inputs and output.
- A specific [slope bias] scaling combination on the operator inputs and output.
- Relative scaling or net slope between multiplication or division operator inputs and output.

Use these methods to map a range of slope and bias values to a replacement function for multiplication or division.

- Equal slope and zero net bias across addition or subtraction operator inputs and output.

Use this method to disregard specific slope and bias values and map relative slope and bias values to a replacement function for addition or subtraction.

Note

- The example `rtwdemo_crlfixpt` demonstrates these replacements and provides example tables that can be used as a starting point for customization.
 - Using fixed-point data types in a model requires a Fixed-Point Designer license.
 - The fixed-point terminology used in this section is defined and explained in the Fixed-Point Designer documentation. See especially “Fixed-Point Numbers” and “Arithmetic Operations”.
-

Fixed-Point Numbers and Arithmetic

Fixed-point numbers use integers and integer arithmetic to represent real numbers and arithmetic with the following encoding scheme:

$$V = \tilde{V} = SQ + B$$

where

- V is an arbitrarily precise real-world value.
- \tilde{V} is the approximate real-world value that results from fixed-point representation.
- Q is an integer that encodes \tilde{V} , referred to as the *quantized integer*.
- S is a coefficient of Q , referred to as the *slope*.
- B is an additive correction, referred to as the *bias*.

The general equation for an operation between fixed-point operands is as follows:

$$(S_o Q_o + B_o) \langle op \rangle (S_2 Q_2 + B_2)$$

The objective of CRL fixed-point operator replacement is to replace an operator that accepts and returns fixed-point or integer inputs and output with a function that accepts and returns built-in C numeric data types (not fixed-point data types). The following sections provide additional programming information for each supported operator.

Addition

The operation $V_0 = V_1 + V_2$ implies that

$$Q_0 = \left(\frac{S_1}{S_0} \right) Q_1 + \left(\frac{S_2}{S_0} \right) Q_2 + \left(\frac{B_1 + B_2 - B_0}{S_0} \right)$$

If an addition replacement function is defined such that the scaling on the operands and sum are equal and the net bias

$$\left(\frac{B_1 + B_2 - B_0}{S_0} \right)$$

is zero (for example, a function `s8_add_s8_s8` that adds two signed 8-bit values and produces a signed 8-bit result), then the CRL operator entry must set the operator entry parameters `SlopesMustBeTheSame` and `MustHaveZeroNetBias` to true. (For parameter descriptions, see the reference page for the function `setTf1COperationEntryParameters`.)

Subtraction

The operation $V_0 = V_1 - V_2$ implies that

$$Q_0 = \left(\frac{S_1}{S_0} \right) Q_1 - \left(\frac{S_2}{S_0} \right) Q_2 + \left(\frac{B_1 - B_2 - B_0}{S_0} \right)$$

If a subtraction replacement function is defined such that the scaling on the operands and difference are equal and the net bias

$$\left(\frac{B_1 - B_2 - B_0}{S_0} \right)$$

is zero (for example, a function `s8_sub_s8_s8` that subtracts two signed 8-bit values and produces a signed 8-bit result), then the CRL operator entry must set the operator entry parameters `SlopesMustBeTheSame` and `MustHaveZeroNetBias` to true. (For parameter descriptions, see the reference page for the function `setTf1CoperationEntryParameters`.)

Multiplication

There are different ways to specify multiplication replacements. The most direct way is to specify an exact match of the input and output types. This is feasible if a model contains only a few (known) slope and bias combinations. For this, use the `Tf1CoperationEntry` class and specify the exact values of slope and bias on each argument. For scenarios where there are numerous slope/bias combinations, it is not feasible to specify each value with a different CRL entry. For this, use a relative scaling factor (RSF) entry or a net slope entry:

- **Relative scaling factor (RSF) entry:**

The operation $V_0 = V_1 * V_2$ implies, for binary-point-only scaling, that

$$S_0 Q_0 = (S_1 Q_1)(S_2 Q_2)$$

$$Q_0 = \left(\frac{S_1 S_2}{S_0} \right) Q_1 Q_2$$

$$Q_0 = S_n Q_1 Q_2$$

where S_n is the net slope.

Multiplication replacement functions may be defined such that all scaling is contained by a single operand. For example, a replacement function `s8_mul_s8_u8_rsf0p125` can multiply a signed 8-bit value by a factor of [0 ... 0.1245] and produce a signed 8-bit result. The following discussion describes how to convert the slope on each operand into a net factor.

To match a multiplication operation to the `s8_mul_s8_u8_rsf0p125` replacement function, $0 \leq S_n Q_2 \leq 2^{-3}$. Substituting the maximum integer value for Q_2 results in the following match criteria: When $S_n 2^8 = 2^{-3}$, or $S_n = 2^{-11}$, CRL replacement processing maps the multiplication operation to the `s8_mul_s8_u8_rsf0p125` function.

To accomplish this mapping, the CRL operator entry must define a *relative scaling factor*, $F2^E$, where the values for F and E are provided using operator entry parameters `RelativeScalingFactorF` and `RelativeScalingFactorE`. (For parameter descriptions, see the reference page for the function `setTf1COperationEntryParameters`.) For the `s8_mul_s8_u8_rsf0p125` function, the `RelativeScalingFactorF` would be set to 1 and the `RelativeScalingFactorE` would be set to -3.

Note When an operator entry specifies `RelativeScalingFactorF` and `RelativeScalingFactorE`, zero bias is implied for the inputs and output.

- **Net slope entry:**

Net slope entries are similar to the relative scaling factor entry described above. The difference is the match criteria. For a net slope entry, the net slope of the call-site operation, S_n , must match the specified net slope, $S_n = F2^E$, without regard to the maximum integer value. Specify the desired net slope F and E values using operator entry parameters `NetSlopeAdjustmentFactor` and `NetFixedExponent`. (For parameter descriptions, see the reference page for the function `setTf1COperationEntryParameters`.)

Note When an operator entry specifies `NetSlopeAdjustmentFactor` and `NetFixedExponent`, matching entries must have arguments with zero bias.

Division

There are different ways to specify division replacements. The most direct way is to specify an exact match of the input and output types. This is feasible if a model contains only a few (known) slope and bias combinations. For this,

use the `Tf1COperationEntry` class and specify the exact values of slope and bias on each argument. For scenarios where there are numerous slope/bias combinations, it is not feasible to specify each value with a different CRL entry. For this, use a relative scaling factor (RSF) entry or a net slope entry:

- **Relative scaling factor (RSF) entry:**

The operation $V_0 = (V_1 / V_2)$ implies, for binary-point-only scaling, that

$$S_0 Q_0 = \left(\frac{S_1 Q_1}{S_2 Q_2} \right)$$

$$Q_0 = S_n \left(\frac{Q_1}{Q_2} \right)$$

where S_n is the net slope.

As with multiplication, division replacement functions may be defined such that all scaling is contained by a single operand. For example, a replacement function `s16_rsf0p5_div_s16_s16` can divide a signed 16<<16 value by a signed 16-bit value and produce a signed 16-bit result. The following discussion describes how to convert the slope on each operand into a net factor.

To match a division operation to the `s16_rsf0p5_div_s16_s16` replacement function, $0 \leq S_n Q_1 \leq 2^{-1}$. Substituting the maximum integer value for Q_1 results in the following match criteria: When $S_n 2^{15} = 2^{-1}$, or $S_n = 2^{-16}$, CRL replacement processing maps the division operation to the `s8_mul_s8_u8_rsf0p125` function.

To accomplish this mapping, the CRL operator entry must define a *relative scaling factor*, $F2^E$, where the values for F and E are provided using operator entry parameters `RelativeScalingFactorF` and `RelativeScalingFactorE`. (For parameter descriptions, see the reference page for the function `setTf1COperationEntryParameters`.) For the `s16_rsf0p5_div_s16_s16` function, the `RelativeScalingFactorF` would be set to 1 and the `RelativeScalingFactorE` would be set to -1.

Note When an operator entry specifies `RelativeScalingFactorF` and `RelativeScalingFactorE`, zero bias is implied for the inputs and output.

- **Net slope entry:**

Net slope entries are similar to the relative scaling factor entry described above. The difference is the match criteria. For a net slope entry, the net slope of the call-site operation, S_n , must match the specified net slope, $S_n = F2^E$, without regard to the maximum integer value. Specify the desired net slope F and E values using operator entry parameters `NetSlopeAdjustmentFactor` and `NetFixedExponent`. (For parameter descriptions, see the reference page for the function `setTf1COperationEntryParameters`.)

Note When an operator entry specifies `NetSlopeAdjustmentFactor` and `NetFixedExponent`, matching entries must have arguments with zero bias.

Data Type Conversion (Cast)

The data type conversion operation $V_0 = V_1$ implies, for binary-point-only scaling, that

$$Q_0 = \left(\frac{S_1}{S_0} \right) Q_1$$

$$Q_0 = S_n Q_1$$

where S_n is the net slope.

Shift

The shift left or shift right operation $V_0 = (V_1 / 2^n)$ implies, for binary-point-only scaling, that

$$S_0 Q_0 = \left(\frac{S_1 Q_1}{2^n} \right)$$

$$Q_0 = \left(\frac{S_1}{S_0} \right) + \left(\frac{Q_1}{2^n} \right)$$

$$Q_0 = S_n \left(\frac{Q_1}{2^n} \right)$$

where S_n is the net slope.

Create Fixed-Point Operator Entries

To create CRL table entries for fixed-point operators, you use the “Create Function and Operator Entries” on page 23-25 and specify fixed-point parameter/value pairs to the functions shown in the following table.

Function	Description
createAndAddConceptualArg	Create conceptual argument from specified properties and add to conceptual arguments for CRL table entry
createAndAddImplementationArg	Create implementation argument from specified properties and add to implementation arguments for CRL table entry
createAndSetCImplementationReturn	Create implementation return argument from specified properties and add to implementation for CRL table entry
setTf1COperationEntryParameters	Set specified parameters for operator entry in CRL table

The following table maps some common methods of matching CRL fixed-point operator table entries to the associated fixed-point parameters that you need to specify in your CRL table definition file.

To match...	Instantiate class...	Minimally specify parameters...
<p>A specific binary-point-only scaling combination on the operator inputs and output</p> <p>See “Create Fixed-Point Operator Entries for Binary-Point-Only Scaling” on page 23-93.</p>	RTW.Tf1COperationEntry	<p>createAndAddConceptualArg function:</p> <ul style="list-style-type: none"> • CheckSlope: Specify the value true. • CheckBias: Specify the value true. • DataTypeMode (or DataType/Scaling equivalent): Specify fixed-point binary-point-only scaling. • FractionLength: Specify a fraction length (for example, 3).
<p>A specific [slope bias] scaling combination on the operator inputs and output</p> <p>See “Create Fixed-Point Operator Entries for [Slope Bias] Scaling” on page 23-96.</p>	RTW.Tf1COperationEntry	<p>createAndAddConceptualArg function:</p> <ul style="list-style-type: none"> • CheckSlope: Specify the value true. • CheckBias: Specify the value true. • DataTypeMode (or DataType/Scaling equivalent): Specify fixed-point [slope bias] scaling. • Slope (or SlopeAdjustmentFactor/-FixedExponent equivalent): Specify a slope value (for example, 15). • Bias: Specify a bias value (for example, 2).
<p>Relative scaling between operator inputs and output (multiplication and division)</p> <p>See “Create Fixed-Point Operator Entries for Relative Scaling</p>	RTW.Tf1COperationEntry-Generator	<p>setTf1COperationEntryParameters function:</p> <ul style="list-style-type: none"> • RelativeScalingFactorF: Specify the slope adjustment factor (F) part of the relative scaling factor, $F2^E$ (for example, 1.0). • RelativeScalingFactorE: Specify the fixed exponent (E) part of the relative scaling factor, $F2^E$ (for example, -3.0).

To match...	Instantiate class...	Minimally specify parameters...
<p>(Multiplication and Division)” on page 23-99.</p>		<p>createAndAddConceptualArg function:</p> <ul style="list-style-type: none"> • CheckSlope: Specify the value false. • CheckBias: Specify the value false. • DataType: Specify the value 'Fixed'.
<p>Net slope between operator inputs and output (multiplication and division)</p> <p>See “Create Fixed-Point Operator Entries for Net Slope (Multiplication and Division)” on page 23-103.</p>	<p>RTW.Tf1COperationEntry-Generator_NetSlope</p>	<p>setTf1COperationEntryParameters function:</p> <ul style="list-style-type: none"> • NetSlopeAdjustmentFactor: Specify the slope adjustment factor (F) part of the net slope, $F2^E$ (for example, 1.0). • NetFixedExponent: Specify the fixed exponent (E) part of the net slope, $F2^E$ (for example, -3.0). <p>createAndAddConceptualArg function:</p> <ul style="list-style-type: none"> • CheckSlope: Specify the value false. • CheckBias: Specify the value false. • DataType: Specify the value 'Fixed'.
<p>Equal slope and zero net bias across operator inputs and output (addition and subtraction)</p> <p>See “Create Fixed-Point Operator Entries for Equal Slope and Zero Net Bias (Addition and</p>	<p>RTW.Tf1COperationEntry-Generator</p>	<p>setTf1COperationEntryParameters function:</p> <ul style="list-style-type: none"> • SlopesMustBeTheSame: Specify the value true. • MustHaveZeroNetBias: Specify the value true. <p>createAndAddConceptualArg function:</p> <ul style="list-style-type: none"> • CheckSlope: Specify the value false.

To match...	Instantiate class...	Minimally specify parameters...
Subtraction” on page 23-106.		<ul style="list-style-type: none"> • CheckBias: Specify the value false.

Create Fixed-Point Operator Entries for Binary-Point-Only Scaling

CRL table entries for operations on fixed-point data types can be defined as matching a specific binary-point-only scaling combination on the operator inputs and output. These binary-point-only scaling entries can map the specified binary-point-scaling combination to a replacement function for addition, subtraction, multiplication, or division.

The following example uses the method described in “Create Function and Operator Entries” on page 23-25 to create a CRL table entry for multiplication of fixed-point data types where arguments are specified with binary-point-only scaling.

Note This example uses MATLAB based APIs to create a CRL table. You can perform the same steps using the Code Replacement Tool graphical interface. For more information, see “Manage CRTs with the Code Replacement Tool” on page 23-168.

In this example:

- The CRL operator entry is instantiated using the `RTW.Tf1C0perationEntry` class.
- The function `setTf1C0perationEntryParameters` is called to set operator entry parameters. These parameters include the type of operation (multiplication), the saturation mode (saturate on overflow), the rounding mode (unspecified), and the name of the replacement function (`s32_mul_s16_s16_binarypoint`).
- The function `createAndAddConceptualArg` is called to create and add conceptual output and input arguments to the operator entry. Each argument specifies that the data type is fixed-point, the mode is binary-point-only scaling, and its derived slope and bias values must

exactly match the call-site slope and bias values. The output argument is 32 bits, signed, with a fraction length of 28, while the input arguments are 16 bits, signed, with fraction lengths of 15 and 13.

- The functions `createAndSetCImplementationReturn` and `createAndAddImplementationArg` are called to create and add implementation output and input arguments to the operator entry. Implementation arguments must describe fundamental numeric data types (not fixed-point data types). In this case, the output argument is 32 bits and signed (`int32`) and the input arguments are 16 bits and signed (`int16`).

```
hTable = RTW.Tf1Table;

op_entry = RTW.Tf1COperationEntry;
setTf1COperationEntryParameters(op_entry, ...
    'Key',                'RTW_OP_MUL', ...
    'Priority',           90, ...
    'SaturationMode',    'RTW_SATURATE_ON_OVERFLOW', ...
    'RoundingModes',     {'RTW_ROUND_UNSPECIFIED'}, ...
    'ImplementationName', 's32_mul_s16_s16_binarypoint', ...
    'ImplementationHeaderFile', 's32_mul_s16_s16_binarypoint.h', ...
    'ImplementationSourceFile', 's32_mul_s16_s16_binarypoint.c');

createAndAddConceptualArg(op_entry, 'RTW.Tf1ArgNumeric', ...
    'Name',              'y1', ...
    'IOType',            'RTW_IO_OUTPUT', ...
    'CheckSlope',        true, ...
    'CheckBias',         true, ...
    'DataTypeMode',      'Fixed-point: binary point scaling', ...
    'IsSigned',          true, ...
    'WordLength',        32, ...
    'FractionLength',    28);

createAndAddConceptualArg(op_entry, 'RTW.Tf1ArgNumeric', ...
    'Name',              'u1', ...
    'IOType',            'RTW_IO_INPUT', ...
    'CheckSlope',        true, ...
    'CheckBias',         true, ...
    'DataTypeMode',      'Fixed-point: binary point scaling', ...
    'IsSigned',          true, ...
```

```

        'WordLength',    16, ...
        'FractionLength', 15);

createAndAddConceptualArg(op_entry, 'RTW.Tf1ArgNumeric', ...
    'Name',            'u2', ...
    'IOType',          'RTW_IO_INPUT', ...
    'CheckSlope',      true, ...
    'CheckBias',       true, ...
    'DataTypeMode',    'Fixed-point: binary point scaling', ...
    'IsSigned',        true, ...
    'WordLength',      16, ...
    'FractionLength',  13);

createAndSetCImplementationReturn(op_entry, 'RTW.Tf1ArgNumeric', ...
    'Name',            'y1', ...
    'IOType',          'RTW_IO_OUTPUT', ...
    'IsSigned',        true, ...
    'WordLength',      32, ...
    'FractionLength',  0);

createAndAddImplementationArg(op_entry, 'RTW.Tf1ArgNumeric',...
    'Name',            'u1', ...
    'IOType',          'RTW_IO_INPUT', ...
    'IsSigned',        true, ...
    'WordLength',      16, ...
    'FractionLength',  0);

createAndAddImplementationArg(op_entry, 'RTW.Tf1ArgNumeric',...
    'Name',            'u2', ...
    'IOType',          'RTW_IO_INPUT', ...
    'IsSigned',        true, ...
    'WordLength',      16, ...
    'FractionLength',  0);

addEntry(hTable, op_entry);

```

To generate code using this table entry, you can follow the general procedure in “Map Scalar Operators to Target-Specific Implementations” on page 23-47, substituting in the code above and an ERT-based model such as the following:

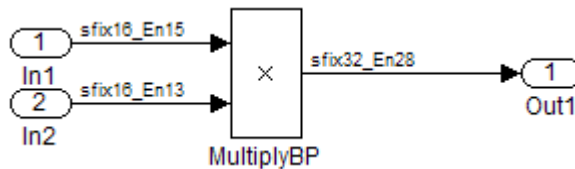

For this model,

- Set the Inport 1 **Data type** to `fixdt(1,16,15)`
- Set the Inport 2 **Data type** to `fixdt(1,16,13)`
- In the Product block:
 - Set **Output data type** to `fixdt(1,32,28)`
 - Select the option **Saturate on integer overflow**

Create Fixed-Point Operator Entries for [Slope Bias] Scaling

CRL table entries for operations on fixed-point data types can be defined as matching a specific [slope bias] scaling combination on the operator inputs and output. These [slope bias] scaling entries can map the specified [slope bias] combination to a replacement function for addition, subtraction, multiplication, or division.

The following example uses the method described in “Create Function and Operator Entries” on page 23-25 to create a CRL table entry for division of fixed-point data types where arguments are specified using [slope bias] scaling.

Note This example uses MATLAB based APIs to create a CRL table. You can perform the same steps using the Code Replacement Tool graphical interface. For more information, see “Manage CRTs with the Code Replacement Tool” on page 23-168.

In this example:

- The CRL operator entry is instantiated using the `RTW.Tf1COperationEntry` class.
- The function `setTf1COperationEntryParameters` is called to set operator entry parameters. These parameters include the type of operation (division), the saturation mode (saturate on overflow), the rounding mode (round to ceiling), and the name of the replacement function (`s16_div_s16_s16_slopebias`).
- The function `createAndAddConceptualArg` is called to create and add conceptual output and input arguments to the operator entry. Each argument specifies that the data type is fixed-point, the mode is [slope bias] scaling, and its specified slope and bias values must exactly match the call-site slope and bias values. The output argument and input arguments are 16 bits, signed, each with specific [slope bias] specifications.
- The functions `createAndSetCImplementationReturn` and `createAndAddImplementationArg` are called to create and add implementation output and input arguments to the operator entry. Implementation arguments must describe fundamental numeric data types (not fixed-point data types). In this case, the output and input arguments are 16 bits and signed (`int16`).

```

hTable = RTW.Tf1Table;

op_entry = RTW.Tf1COperationEntry;
setTf1COperationEntryParameters(op_entry, ...
    'Key',                'RTW_OP_DIV', ...
    'Priority',           90, ...
    'SaturationMode',    'RTW_SATURATE_ON_OVERFLOW', ...
    'RoundingModes',     {'RTW_ROUND_CEILING'}, ...
    'ImplementationName', 's16_div_s16_s16_slopebias', ...
    'ImplementationHeaderFile', 's16_div_s16_s16_slopebias.h', ...
    'ImplementationSourceFile', 's16_div_s16_s16_slopebias.c');

createAndAddConceptualArg(op_entry, 'RTW.Tf1ArgNumeric', ...
    'Name',                'y1', ...
    'IOType',              'RTW_IO_OUTPUT', ...
    'CheckSlope',          true, ...
    'CheckBias',           true, ...
    'DataTypeMode',        'Fixed-point: slope and bias scaling', ...

```

```
        'IsSigned',      true, ...
        'WordLength',   16, ...
        'Slope',        15, ...
        'Bias',         2);

createAndAddConceptualArg(op_entry, 'RTW.Tf1ArgNumeric', ...
    'Name',             'u1', ...
    'IOType',           'RTW_IO_INPUT', ...
    'CheckSlope',      true, ...
    'CheckBias',       true, ...
    'DataTypeMode',    'Fixed-point: slope and bias scaling', ...
    'IsSigned',        true, ...
    'WordLength',      16, ...
    'Slope',           15, ...
    'Bias',            2);

createAndAddConceptualArg(op_entry, 'RTW.Tf1ArgNumeric', ...
    'Name',             'u2', ...
    'IOType',           'RTW_IO_INPUT', ...
    'CheckSlope',      true, ...
    'CheckBias',       true, ...
    'DataTypeMode',    'Fixed-point: slope and bias scaling', ...
    'IsSigned',        true, ...
    'WordLength',      16, ...
    'Slope',           13, ...
    'Bias',            5);

createAndSetCImplementationReturn(op_entry, 'RTW.Tf1ArgNumeric', ...
    'Name',             'y1', ...
    'IOType',           'RTW_IO_OUTPUT', ...
    'IsSigned',        true, ...
    'WordLength',      16, ...
    'FractionLength',  0);

createAndAddImplementationArg(op_entry, 'RTW.Tf1ArgNumeric', ...
    'Name',             'u1', ...
    'IOType',           'RTW_IO_INPUT', ...
    'IsSigned',        true, ...
    'WordLength',      16, ...
    'FractionLength',  0);
```



```

createAndAddImplementationArg(op_entry, 'RTW.Tf1ArgNumeric',...
                                'Name',      'u2', ...
                                'IOType',    'RTW_IO_INPUT', ...
                                'IsSigned',   true, ...
                                'WordLength', 16, ...
                                'FractionLength', 0);

addEntry(hTable, op_entry);

```

To generate code using this table entry, you can follow the general procedure in “Map Scalar Operators to Target-Specific Implementations” on page 23-47, substituting in the code above and an ERT-based model such as the following:

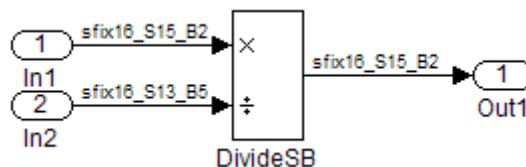

For this model,

- Set the Inport 1 **Data type** to `fixdt(1,16,15,2)`
- Set the Inport 2 **Data type** to `fixdt(1,16,13,5)`
- In the Divide block:
 - Set **Output data type** to `Inherit`: `Inherit via back propagation`
 - Set **Integer rounding mode** to `Ceiling`
 - Select the option **Saturate on integer overflow**

Create Fixed-Point Operator Entries for Relative Scaling (Multiplication and Division)

CRL table entries for multiplication or division of fixed-point data types can be defined as matching relative scaling between operator inputs and output. These relative scaling entries can map a range of slope and bias values to a replacement function for multiplication or division.

The following example uses the method described in “Create Function and Operator Entries” on page 23-25 to create a CRL table entry for division of fixed-point data types using a relative scaling factor.

Note This example uses MATLAB based APIs to create a CRL table. You can perform the same steps using the Code Replacement Tool graphical interface. For more information, see “Manage CRTs with the Code Replacement Tool” on page 23-168.

In this example:

- The CRL operator entry is instantiated using the `RTW.Tf1COperationEntryGenerator` class, which provides access to the fixed-point parameters `RelativeScalingFactorF` and `RelativeScalingFactorE`.
- The function `setTf1COperationEntryParameters` is called to set operator entry parameters. These parameters include the type of operation (division), the saturation mode (saturation off), the rounding mode (round to ceiling), and the name of the replacement function (`s16_div_s16_s16_rsf0p125`). Additionally, `RelativeScalingFactorF` and `RelativeScalingFactorE` are used to specify the F and E parts of the relative scaling factor $F2^E$.
- The function `createAndAddConceptualArg` is called to create and add conceptual output and input arguments to the operator entry. Each argument is specified as fixed-point, 16 bits, and signed. Also, each argument specifies that CRL replacement request processing should *not* check for an exact match to the call-site slope and bias values.
- The functions `createAndSetCImplementationReturn` and `createAndAddImplementationArg` are called to create and add implementation output and input arguments to the operator entry. Implementation arguments must describe fundamental numeric data types (not fixed-point data types). In this case, the output and input arguments are 16 bits and signed (`int16`).

```
hTable = RTW.Tf1Table;
```

```

op_entry = RTW.Tf1COperationEntryGenerator;
setTf1COperationEntryParameters(op_entry, ...
    'Key',                'RTW_OP_DIV', ...
    'Priority',           90, ...
    'SaturationMode',    'RTW_WRAP_ON_OVERFLOW', ...
    'RoundingModes',     {'RTW_ROUND_CEILING'}, ...
    'RelativeScalingFactorF', 1.0, ...
    'RelativeScalingFactorE', -3.0, ...
    'ImplementationName',    's16_div_s16_s16_rsf0p125', ...
    'ImplementationHeaderFile', 's16_div_s16_s16_rsf0p125.h', ...
    'ImplementationSourceFile', 's16_div_s16_s16_rsf0p125.c');

createAndAddConceptualArg(op_entry, 'RTW.Tf1ArgNumeric', ...
    'Name',                'y1', ...
    'IOType',              'RTW_IO_OUTPUT', ...
    'CheckSlope',          false, ...
    'CheckBias',           false, ...
    'DataType',            'Fixed', ...
    'IsSigned',            true, ...
    'WordLength',          16);

createAndAddConceptualArg(op_entry, 'RTW.Tf1ArgNumeric', ...
    'Name',                'u1', ...
    'IOType',              'RTW_IO_INPUT', ...
    'CheckSlope',          false, ...
    'CheckBias',           false, ...
    'DataType',            'Fixed', ...
    'IsSigned',            true, ...
    'WordLength',          16);

createAndAddConceptualArg(op_entry, 'RTW.Tf1ArgNumeric', ...
    'Name',                'u2', ...
    'IOType',              'RTW_IO_INPUT', ...
    'CheckSlope',          false, ...
    'CheckBias',           false, ...
    'DataType',            'Fixed', ...
    'IsSigned',            true, ...
    'WordLength',          16);

createAndSetCImplementationReturn(op_entry, 'RTW.Tf1ArgNumeric', ...

```

```
'Name',          'y1', ...
'IOType',       'RTW_IO_OUTPUT', ...
'IsSigned',    true, ...
'WordLength',  16, ...
'FractionLength', 0);
```

```
createAndAddImplementationArg(op_entry, 'RTW.Tf1ArgNumeric',...
    'Name',          'u1', ...
    'IOType',       'RTW_IO_INPUT', ...
    'IsSigned',    true, ...
    'WordLength',  16, ...
    'FractionLength', 0);
```

```
createAndAddImplementationArg(op_entry, 'RTW.Tf1ArgNumeric',...
    'Name',          'u2', ...
    'IOType',       'RTW_IO_INPUT', ...
    'IsSigned',    true, ...
    'WordLength',  16, ...
    'FractionLength', 0);
```

```
addEntry(hTable, op_entry);
```

To generate code using this table entry, you can follow the general procedure in “Map Scalar Operators to Target-Specific Implementations” on page 23-47, substituting in the code above and an ERT-based model such as the following:

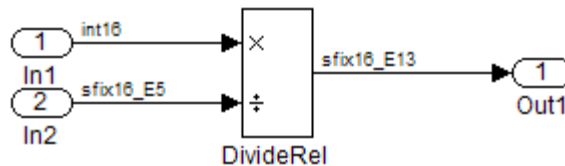

For this model,

- Set the Inport 1 **Data type** to int16
- Set the Inport 2 **Data type** to fixdt(1,16,-5)
- In the Divide block:

- Set **Output data type** to `fixdt(1,16,-13)`
- Set **Integer rounding mode** to `Ceiling`

Create Fixed-Point Operator Entries for Net Slope (Multiplication and Division)

CRL table entries for multiplication or division of fixed-point data types can be defined as matching net slope between operator inputs and output. These net slope entries can map a range of slope and bias values to a replacement function for multiplication or division.

The following example uses the method described in “Create Function and Operator Entries” on page 23-25 to create a CRL table entry for division of fixed-point data types using a net slope.

Note This example uses MATLAB based APIs to create a CRL table. You can perform the same steps using the Code Replacement Tool graphical interface. For more information, see “Manage CRTs with the Code Replacement Tool” on page 23-168.

In this example:

- The CRL operator entry is instantiated using the `RTW.Tf1COperationEntryGenerator_NetSlope` class, which provides access to the fixed-point parameters `NetSlopeAdjustmentFactor` and `NetFixedExponent`.
- The function `setTf1COperationEntryParameters` is called to set operator entry parameters. These parameters include the type of operation (division), the saturation mode (wrap on overflow), the rounding mode (unspecified), and the name of the replacement function (`user_div_*`). Additionally, `NetSlopeAdjustmentFactor` and `NetFixedExponent` are used to specify the F and E parts of the net slope $F2^E$.
- The function `createAndAddConceptualArg` is called to create and add conceptual output and input arguments to the operator entry. Each argument is specified as fixed-point and signed. Also, each argument specifies that CRL replacement request processing should *not* check for an exact match to the call-site slope and bias values.

- The function `getTf1ArgFromString` is called to create implementation output and input arguments that are added to the operator entry. Implementation arguments must describe fundamental numeric data types (not fixed-point data types).

```

hTable = RTW.Tf1Table;

wv = [16,32];
for iy = 1:2
    for inum = 1:2
        for iden = 1:2
            hTable = getDivOpEntry(hTable, ...
                                   fixdt(1,wv(iy)),fixdt(1,wv(inum)),fixdt(1,wv(iden)));
        end
    end
end

%-----
function hTable = getDivOpEntry(hTable,dti,dtnum,dtden)
%-----
% Create an entry for division of fixed-point data types where
% arguments are specified using Slope and Bias scaling
% Saturation on, Rounding unspecified

funcStr = sprintf('user_div_%s_%s_%s',...
                  typeStrFunc(dti),...
                  typeStrFunc(dtnum),...
                  typeStrFunc(dtden));

op_entry = RTW.Tf1COperationEntryGenerator_NetSlope;
setTf1COperationEntryParameters(op_entry, ...
                                'Key',          'RTW_OP_DIV', ...
                                'Priority',     90, ...
                                'SaturationMode', 'RTW_WRAP_ON_OVERFLOW',...
                                'RoundingModes', {'RTW_ROUND_UNSPECIFIED'},...
                                'NetSlopeAdjustmentFactor', 1.0, ...
                                'NetFixedExponent', 0.0, ...
                                'ImplementationName', funcStr, ...
                                'ImplementationHeaderFile', [funcStr,'.h'], ...

```

```

        'ImplementationSourceFile', [funcStr, '.c'] );

createAndAddConceptualArg(op_entry, ...
    'RTW.Tf1ArgNumeric', ...
    'Name',          'y1',...
    'IOType',        'RTW_IO_OUTPUT',...
    'CheckSlope',    false,...
    'CheckBias',     false,...
    'DataTypeMode',  'Fixed-point: slope and bias scaling',...
    'IsSigned',      dtty.Signed,...
    'WordLength',    dtty.WordLength,...
    'Bias',          0);

createAndAddConceptualArg(op_entry, ...
    'RTW.Tf1ArgNumeric',...
    'Name',          'u1', ...
    'IOType',        'RTW_IO_INPUT',...
    'CheckSlope',    false,...
    'CheckBias',     false,...
    'DataTypeMode',  'Fixed-point: slope and bias scaling',...
    'IsSigned',      dtnum.Signed,...
    'WordLength',    dtnum.WordLength,...
    'Bias',          0);

createAndAddConceptualArg(op_entry, ...
    'RTW.Tf1ArgNumeric', ...
    'Name',          'u2', ...
    'IOType',        'RTW_IO_INPUT',...
    'CheckSlope',    false,...
    'CheckBias',     false,...
    'DataTypeMode',  'Fixed-point: slope and bias scaling',...
    'IsSigned',      dtden.Signed,...
    'WordLength',    dtden.WordLength,...
    'Bias',          0);

arg = getTf1ArgFromString(hTable, 'y1', typeStrBase(dtty));
op_entry.Implementation.setReturn(arg);

arg = getTf1ArgFromString(hTable, 'u1', typeStrBase(dtnum));
op_entry.Implementation.addArgument(arg);

```

```

arg = getTf1ArgFromString(hTable, 'u2',typeStrBase(dtDen));
op_entry.Implementation.addArgument(arg);

addEntry(hTable, op_entry);

%-----
function str = typeStrFunc(dt)
%-----

if dt.Signed
    sstr = 's';
else
    sstr = 'u';
end
str = sprintf('%s%d',sstr,dt.WordLength);

%-----
function str = typeStrBase(dt)
%-----

if dt.Signed
    sstr = ;
else
    sstr = 'u';
end
str = sprintf('%sint%d',sstr,dt.WordLength);

```

Create Fixed-Point Operator Entries for Equal Slope and Zero Net Bias (Addition and Subtraction)

CRL table entries for addition or subtraction of fixed-point data types can be defined as matching relative slope and bias values (equal slope and zero net bias) across operator inputs and output. These entries allow you to disregard specific slope and bias values and map relative slope and bias values to a replacement function for addition or subtraction.

The following example uses the method described in “Create Function and Operator Entries” on page 23-25 to create a CRL table entry for addition of

fixed-point data types where slopes must be equal and net bias must be zero across the operator inputs and output.

Note This example uses MATLAB based APIs to create a CRL table. You can perform the same steps using the Code Replacement Tool graphical interface. For more information, see “Manage CRTs with the Code Replacement Tool” on page 23-168.

In this example:

- The CRL operator entry is instantiated using the `RTW.Tf1COperationEntryGenerator` class, which provides access to the fixed-point parameters `SlopesMustBeTheSame` and `MustHaveZeroNetBias`.
- The function `setTf1COperationEntryParameters` is called to set operator entry parameters. These parameters include the type of operation (addition), the saturation mode (saturation off), the rounding mode (unspecified), and the name of the replacement function (`u16_add_SameSlopeZeroBias`). Additionally, `SlopesMustBeTheSame` and `MustHaveZeroNetBias` are set to `true` to indicate that slopes must be equal and net bias must be zero across the addition inputs and output.
- The function `createAndAddConceptualArg` is called to create and add conceptual output and input arguments to the operator entry. Each argument is specified as 16 bits and unsigned. Also, each argument specifies that CRL replacement request processing should *not* check for an exact match to the call-site slope and bias values.
- The functions `createAndSetCImplementationReturn` and `createAndAddImplementationArg` are called to create and add implementation output and input arguments to the operator entry. Implementation arguments must describe fundamental numeric data types (not fixed-point data types). In this case, the output and input arguments are 16 bits and unsigned (`uint16`).

```
hTable = RTW.Tf1Table;
```

```
op_entry = RTW.Tf1COperationEntryGenerator;  
setTf1COperationEntryParameters(op_entry, ...
```

```

        'Key',                'RTW_OP_ADD', ...
        'Priority',           90, ...
        'SaturationMode',    'RTW_WRAP_ON_OVERFLOW', ...
        'RoundingModes',     {'RTW_ROUND_UNSPECIFIED'}, ...
        'SlopesMustBeTheSame', true, ...
        'MustHaveZeroNetBias', true, ...
        'ImplementationName', 'u16_add_SameSlopeZeroBias', ...
        'ImplementationHeaderFile', 'u16_add_SameSlopeZeroBias.h', ...
        'ImplementationSourceFile', 'u16_add_SameSlopeZeroBias.c');

createAndAddConceptualArg(op_entry, 'RTW.Tf1ArgNumeric', ...
    'Name',                'y1', ...
    'IOType',              'RTW_IO_OUTPUT', ...
    'CheckSlope',          false, ...
    'CheckBias',           false, ...
    'IsSigned',            false, ...
    'WordLength',          16);

createAndAddConceptualArg(op_entry, 'RTW.Tf1ArgNumeric', ...
    'Name',                'u1', ...
    'IOType',              'RTW_IO_INPUT', ...
    'CheckSlope',          false, ...
    'CheckBias',           false, ...
    'IsSigned',            false, ...
    'WordLength',          16);

createAndAddConceptualArg(op_entry, 'RTW.Tf1ArgNumeric', ...
    'Name',                'u2', ...
    'IOType',              'RTW_IO_INPUT', ...
    'CheckSlope',          false, ...
    'CheckBias',           false, ...
    'IsSigned',            false, ...
    'WordLength',          16);

createAndSetCImplementationReturn(op_entry, 'RTW.Tf1ArgNumeric', ...
    'Name',                'y1', ...
    'IOType',              'RTW_IO_OUTPUT', ...
    'IsSigned',            false, ...
    'WordLength',          16, ...
    'FractionLength',      0);

```

```

createAndAddImplementationArg(op_entry, 'RTW.Tf1ArgNumeric',...
                               'Name',      'u1', ...
                               'IOType',    'RTW_IO_INPUT', ...
                               'IsSigned',  false, ...
                               'WordLength', 16, ...
                               'FractionLength', 0);

createAndAddImplementationArg(op_entry, 'RTW.Tf1ArgNumeric',...
                               'Name',      'u2', ...
                               'IOType',    'RTW_IO_INPUT', ...
                               'IsSigned',  false, ...
                               'WordLength', 16, ...
                               'FractionLength', 0);

addEntry(hTable, op_entry);

```

To generate code using this table entry, you can follow the general procedure in “Map Scalar Operators to Target-Specific Implementations” on page 23-47, substituting in the code above and an ERT-based model such as the following:

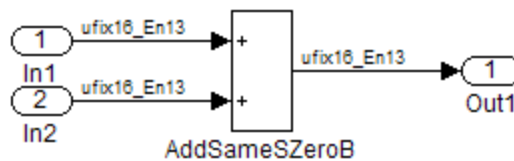

For this model,

- Set the Inport 1 **Data type** to `fixdt(0,16,13)`
- Set the Inport 2 **Data type** to `fixdt(0,16,13)`
- In the Add block:
 - Verify that **Output data type** is set to its default, Inherit via internal rule
 - Set **Integer rounding mode** to Zero

Map Data Type Conversion (Cast) Operations to Target-Specific Implementations

- “Create a CRL Entry to Replace Casts From int32 To int16” on page 23-110
- “Create a CRL Entry to Replace Fixed-Point Casts Using Net Slope” on page 23-111

You can use CRL table entries to replace the default generated code for data type conversion (cast) operations with calls to optimized functions.

For details of the arithmetic supported for replacement of data type conversion, see the data type conversion (cast) subsection of “Fixed-Point Numbers and Arithmetic” on page 23-84.

Create a CRL Entry to Replace Casts From int32 To int16. The following example uses the method described in “Create Function and Operator Entries” on page 23-25 to create a CRL table entry to replace int32 to int16 data type conversion (cast) operations. In this example:

- The CRL operator entry is instantiated using the `RTW.Tf1COperationEntry` class.
- The function `setTf1COperationEntryParameters` is called to set operator entry parameters. These parameters include the type of operation (cast), the saturation mode (saturate on overflow), the rounding mode (toward negative infinity), and the name of the replacement function (`my_sat_cast`).
- The function `getTf1ArgFromString` is called to create an int16 output argument, which is then added to the operator entry both as the first conceptual argument and the implementation return argument.
- The function `getTf1ArgFromString` is called to create an int32 input argument, which is then added to the operator entry both as the second conceptual argument and the sole implementation input argument.

```
hTable = RTW.Tf1Table;  
  
% Create an int16 to int32 cast replacement  
op_entry = RTW.Tf1COperationEntry;  
setTf1COperationEntryParameters(op_entry, ...
```

```

        'Key',                'RTW_OP_CAST', ...
        'Priority',          50, ...
        'ImplementationName', 'my_sat_cast', ...
        'SaturationMode',   'RTW_SATURATE_ON_OVERFLOW', ...
        'RoundingModes',   {'RTW_ROUND_FLOOR'}, ...
        'ImplementationHeaderFile', 'some_hdr.h', ...
        'ImplementationSourceFile', 'some_hdr.c');

% Create int16 arg as conceptual arg 1 and implementation return
arg = getTf1ArgFromString(hTable, 'y1', 'int16');
arg.IOType = 'RTW_IO_OUTPUT';
addConceptualArg(op_entry, arg);
op_entry.Implementation.setReturn(arg);

% Create int32 arg as conceptual arg 2 and implementation input arg 1
arg = getTf1ArgFromString(hTable, 'u1', 'int32');
addConceptualArg(op_entry, arg);
op_entry.Implementation.addArgument(arg);

addEntry(hTable, op_entry);

```

Create a CRL Entry to Replace Fixed-Point Casts Using Net Slope.

The following example uses the method described in “Create Function and Operator Entries” on page 23-25 to create a CRL table entry to replace data type conversions (casts) of fixed-point data types using a net slope.

Note This example uses MATLAB based APIs to create a CRL table. You can perform the same steps using the Code Replacement Tool graphical interface. For more information, see “Manage CRTs with the Code Replacement Tool” on page 23-168.

In this example:

- The CRL operator entry is instantiated using the `RTW.Tf1COperationEntryGenerator_NetSlope` class, which provides access to the fixed-point parameters `NetSlopeAdjustmentFactor` and `NetFixedExponent`.

- The function `setTf1COperationEntryParameters` is called to set operator entry parameters. These parameters include the type of operation (cast), the saturation mode (saturate on overflow), the rounding mode (toward negative infinity), and the name of the replacement function (`my_fxp_cast`). Additionally, `NetSlopeAdjustmentFactor` and `NetFixedExponent` are used to specify the F and E parts of the net slope $F2^E$.
- The function `createAndAddConceptualArg` is called to create conceptual output and input arguments that are added to the operator entry. Each argument is specified as fixed-point and signed. Also, each argument specifies that CRL replacement request processing should *not* check for an exact match to the call-site slope and bias values.
- The functions `createAndSetCImplementationReturn` and `createAndAddImplementationArg` are called to create implementation return and input arguments that are added to the operator entry. Implementation arguments must describe fundamental numeric data types (not fixed-point data types).

```

hTable = RTW.Tf1Table;

% Create a fixed-point cast replacement using a NetSlope entry
op_entry = RTW.Tf1COperationEntryGenerator_NetSlope;
InFL = 2;
InWL = 16;
InSgn = true;
OutFL = 4;
OutWL = 32;
OutSgn = true;
setTf1COperationEntryParameters(op_entry, ...
    'Key', 'RTW_OP_CAST', ...
    'Priority', 50, ...
    'SaturationMode', 'RTW_SATURATE_ON_OVERFLOW', ...
    'RoundingModes', {'RTW_ROUND_FLOOR'}, ...
    'NetSlopeAdjustmentFactor', 1.0, ...
    'NetFixedExponent', (OutFL - InFL), ...
    'ImplementationName', 'my_fxp_cast', ...
    'ImplementationHeaderFile', 'some_hdr.h', ...
    'ImplementationSourceFile', 'some_hdr.c');

createAndAddConceptualArg(op_entry, 'RTW.Tf1ArgNumeric', ...

```

```

        'Name',          'y1', ...
        'IOType',       'RTW_IO_OUTPUT', ...
        'CheckSlope',  false, ...
        'CheckBias',   false, ...
        'DataTypeMode', 'Fixed-point: binary point scaling', ...
        'IsSigned',    OutSgn, ...
        'WordLength',  OutWL, ...
        'FractionLength',OutFL);

createAndAddConceptualArg(op_entry, 'RTW.Tf1ArgNumeric', ...
        'Name',          'u1', ...
        'IOType',       'RTW_IO_INPUT', ...
        'CheckSlope',  false, ...
        'CheckBias',   false, ...
        'DataTypeMode', 'Fixed-point: binary point scaling', ...
        'IsSigned',    InSgn, ...
        'WordLength',  InWL, ...
        'FractionLength',InFL);

createAndSetCImplementationReturn(op_entry, 'RTW.Tf1ArgNumeric', ...
        'Name',          'y1', ...
        'IOType',       'RTW_IO_OUTPUT', ...
        'IsSigned',     OutSgn, ...
        'WordLength',   OutWL, ...
        'FractionLength', 0);

createAndAddImplementationArg(op_entry, 'RTW.Tf1ArgNumeric',...
        'Name',          'u1', ...
        'IOType',       'RTW_IO_INPUT', ...
        'IsSigned',     InSgn, ...
        'WordLength',   InWL, ...
        'FractionLength', 0);

addEntry(hTable, op_entry);

```

Map Fixed-Point Shift Left Operations to Target-Specific Implementations

- “Create a CRL Entry to Replace Shift Lefts for int16 Data” on page 23-114

- “Create a CRL Entry to Replace Fixed-Point Shift Lefts Using Net Slope” on page 23-115

You can use CRL table entries to replace the default generated code for << (shift left) operations with calls to optimized functions.

For details of the arithmetic supported for replacement of shift-left operations, see the shift left subsection of “Fixed-Point Numbers and Arithmetic” on page 23-84.

Create a CRL Entry to Replace Shift Lefts for int16 Data. The following example uses the method described in “Create Function and Operator Entries” on page 23-25 to create a CRL table entry to replace << (shift left) operations for int16 data. In this example:

- The CRL operator entry is instantiated using the `RTW.Tf1COperationEntry` class.
- The function `setTf1COperationEntryParameters` is called to set operator entry parameters. These parameters include the type of operation (shift left) and the name of the replacement function (`my_shift_left`).
- The function `getTf1ArgFromString` is called to create an int16 output argument, which is then added to the operator entry both as the first conceptual argument and the implementation return argument.
- The function `getTf1ArgFromString` is called to create an int16 input argument, which is then added to the operator entry both as the second conceptual argument and the first implementation input argument.
- The function `getTf1ArgFromString` is called to create an int8 input argument, which is then added to the operator entry both as the third conceptual argument and the second implementation input argument. This argument specifies the number of bits to shift the previous input argument. Since the argument type is not relevant, type checking is disabled by setting the `CheckType` property to `false`.

```
hTable = RTW.Tf1Table;  
  
% Create a shift left replacement for int16 data  
op_entry = RTW.Tf1COperationEntry;  
setTf1COperationEntryParameters(op_entry, ...
```



```

        'Key',                'RTW_OP_SL', ...
        'Priority',          50, ...
        'ImplementationName', 'my_shift_left', ...
        'ImplementationHeaderFile', 'some_hdr.h', ...
        'ImplementationSourceFile', 'some_hdr.c');

% Create int16 arg as conceptual arg 1 and implementation return
arg = getTf1ArgFromString(hTable, 'y1', 'int16');
arg.IOType = 'RTW_IO_OUTPUT';
addConceptualArg(op_entry, arg);
op_entry.Implementation.setReturn(arg);

% Create int16 arg as conceptual arg 2 and implementation input arg 1
arg = getTf1ArgFromString(hTable, 'u1', 'int16');
addConceptualArg(op_entry, arg);
op_entry.Implementation.addArgument(arg);

% Create int8 arg as conceptual arg 3 and implementation input arg 2
% Turn off type checking for number of bits to shift argument
arg = getTf1ArgFromString(hTable, 'u2', 'int8');
arg.CheckType = false;
addConceptualArg(op_entry, arg);
op_entry.Implementation.addArgument(arg);

addEntry(hTable, op_entry);

```

Create a CRL Entry to Replace Fixed-Point Shift Lefts Using Net Slope.

The following example uses the method described in “Create Function and Operator Entries” on page 23-25 to create a CRL table entry to replace << (shift left) operations for fixed-point data using a net slope. In this example:

- The CRL operator entry is instantiated using the `RTW.Tf1COperationEntryGenerator_NetSlope` class, which provides access to the fixed-point parameters `NetSlopeAdjustmentFactor` and `NetFixedExponent`.
- The function `setTf1COperationEntryParameters` is called to set operator entry parameters. These parameters include the type of operation (shift left), the saturation mode (saturate on overflow), the rounding mode (toward negative infinity), and the name of the replacement function

(my_fxp_shift_left). Additionally, NetSlopeAdjustmentFactor and NetFixedExponent are used to specify the F and E parts of the net slope $F2^E$.

- The function createAndAddConceptualArg is called to create conceptual output and input arguments that are added to the operator entry. Each argument is specified as fixed-point and signed. Also, each argument specifies that CRL replacement request processing should *not* check for an exact match to the call-site slope and bias values.
- The functions createAndSetCImplementationReturn and createAndAddImplementationArg are called to create implementation return and input arguments that are added to the operator entry. Implementation arguments must describe fundamental numeric data types (not fixed-point data types).
- The function getTf1ArgFromString is called to create a uint8 input argument, which is then added to the operator entry both as the third conceptual argument and the second implementation input argument. This argument specifies the number of bits to shift the previous input argument. Since the argument type is not relevant, type checking is disabled by setting the CheckType property to false.

```
hTable = RTW.Tf1Table;

% Create a fixed-point shift left replacement using a NetSlope entry
op_entry = RTW.Tf1COperationEntryGenerator_NetSlope;
InFL = 2;
InWL = 16;
InSgn = true;
OutFL = 4;
OutWL = 32;
OutSgn = true;
setTf1COperationEntryParameters(op_entry, ...
    'Key', 'RTW_OP_SL', ...
    'Priority', 50, ...
    'SaturationMode', 'RTW_SATURATE_ON_OVERFLOW', ...
    'RoundingModes', {'RTW_ROUND_FLOOR'}, ...
    'NetSlopeAdjustmentFactor', 1.0, ...
    'NetFixedExponent', (OutFL - InFL), ...
    'ImplementationName', 'my_fxp_shift_left', ...
    'ImplementationHeaderFile', 'some_hdr.h', ...
```

```

'ImplementationSourceFile', 'some_hdr.c');

% Create fixed-point arg as conceptual arg 1
createAndAddConceptualArg(op_entry, 'RTW.Tf1ArgNumeric', ...
    'Name',          'y1', ...
    'IOType',        'RTW_IO_OUTPUT', ...
    'CheckSlope',    false, ...
    'CheckBias',     false, ...
    'DataTypeMode',  'Fixed-point: binary point scaling', ...
    'IsSigned',      OutSgn, ...
    'WordLength',    OutWL, ...
    'FractionLength',OutFL);

% Create fixed-point arg as conceptual arg 2
createAndAddConceptualArg(op_entry, 'RTW.Tf1ArgNumeric', ...
    'Name',          'u1', ...
    'IOType',        'RTW_IO_INPUT', ...
    'CheckSlope',    false, ...
    'CheckBias',     false, ...
    'DataTypeMode',  'Fixed-point: binary point scaling', ...
    'IsSigned',      InSgn, ...
    'WordLength',    InWL, ...
    'FractionLength',InFL);

% Create implementation return arg
createAndSetCImplementationReturn(op_entry, 'RTW.Tf1ArgNumeric', ...
    'Name',          'y1', ...
    'IOType',        'RTW_IO_OUTPUT', ...
    'IsSigned',      OutSgn, ...
    'WordLength',    OutWL, ...
    'FractionLength', 0);

% Create implementation input arg 1
createAndAddImplementationArg(op_entry, 'RTW.Tf1ArgNumeric', ...
    'Name',          'u1', ...
    'IOType',        'RTW_IO_INPUT', ...
    'IsSigned',      InSgn, ...
    'WordLength',    InWL, ...
    'FractionLength', 0);

```

```
% Create uint8 arg as conceptual arg 3 and implementation input arg 2
% Turn off type checking for number of bits to shift argument
arg = getTf1ArgFromString(hTable, 'u2', 'uint8');
arg.CheckType = false;
addConceptualArg(op_entry, arg);
op_entry.Implementation.addArgument(arg);

addEntry(hTable, op_entry);
```

Remap Operator Outputs to Implementation Function Inputs

If you need your generated code to meet a specific coding pattern or you want more flexibility, for example, to further improve performance, you have the option of remapping operator outputs to input positions in an implementation function argument list.

Note Remapping outputs to implementation function inputs is supported only for operator replacement.

For example, for a sum operation, the build process might generate code similar to the following:

```
add8_Y.Out1 = u8_add_u8_u8(add8_U.In1, add8_U.In2);
```

If you remap the output to the first input, the build process generates code similar to the following:

```
u8_add_u8_u8(&add8_Y.Out1;, add8_U.In1, add8_U.In2);
```

Note To prevent generation of extra data copies in the code, select the model configuration option **Minimize data copies between local and global variables** (EnhancedBackFolding) on the **Optimization > Signals and Parameters** pane of the Configuration Parameters dialog box.

To remap an operator output to an implementation function input for an existing CRL operator replacement entry, you modify the CRL table definition file as follows.

- 1** In the `setTf1COperationEntryParameters` function call for the operator replacement, specify the `SideEffects` parameter as `true`.
- 2** When defining the implementation function return, create a new void output argument, for example, `y2`.
- 3** When defining the implementation function arguments, set the operator output argument (for example, `y1`) as an additional input argument, marking its `IOType` as output, and make its type a pointer type.

For example, the following CRL table definition file for a sum operation has been modified to remap operator output `y1` as the first function input argument. The modified lines of code are shown in **bold** type. (This definition file generated the example remap code shown above.)

Note To exercise this example, you can use the registration file, model, and instructions shown in “Map Scalar Operators to Target-Specific Implementations” on page 23-47.

```
function hTable = crl_table_add_uint8
%CRL_TABLE_ADD_UINT8 - Describe operator entry for a Code Replacement Library table.

hTable = RTW.Tf1Table;

% Create entry for addition of built-in uint8 data type
op_entry = RTW.Tf1COperationEntry;
setTf1COperationEntryParameters(op_entry, ...
    'Key', 'RTW_OP_ADD', ...
    'Priority', 90, ...
    'ImplementationName', 'u8_add_u8_u8', ...
    'ImplementationHeaderFile', 'u8_add_u8_u8.h', ...
    'ImplementationSourceFile', 'u8_add_u8_u8.c', ...
    'SideEffects', true );
```

```
arg = getTf1ArgFromString(hTable, 'y1', 'uint8');
arg.IOType = 'RTW_IO_OUTPUT';
addConceptualArg(op_entry, arg);

arg = getTf1ArgFromString(hTable, 'u1', 'uint8');
addConceptualArg(op_entry, arg );

arg = getTf1ArgFromString(hTable, 'u2', 'uint8');
addConceptualArg(op_entry, arg );

% Create new void output y2
arg = getTf1ArgFromString(hTable, 'y2', 'void');
arg.IOType = 'RTW_IO_OUTPUT';
op_entry.Implementation.setReturn(arg);

% Set y1 as first input arg, mark IOType as output, and use pointer type
arg=getTf1ArgFromString(hTable, 'y1', 'uint8*');
arg.IOType = 'RTW_IO_OUTPUT';
op_entry.Implementation.addArgument(arg);

arg=getTf1ArgFromString(hTable, 'u1', 'uint8');
op_entry.Implementation.addArgument(arg);

arg=getTf1ArgFromString(hTable, 'u2', 'uint8');
op_entry.Implementation.addArgument(arg);

addEntry(hTable, op_entry);
```

Configure Data Alignment for Function Implementations

- “About CRL-Specified Data Alignment” on page 23-121
- “Specify Data Alignment Requirements for Function Arguments” on page 23-121
- “Provide Data Alignment Specifications for Compilers” on page 23-123
- “Basic Example of CRL-Specified Data Alignment” on page 23-127
- “Data Alignment Limitations” on page 23-132

About CRL-Specified Data Alignment

CRLs provide the ability to align data objects passed into a replacement function to a specified boundary. This allows you to take advantage of target-specific function implementations that require data to be aligned in order to optimize application performance. To configure data alignment for a function implementation:

- 1 Specify the data alignment requirements in a CRL table entry. Alignment can be specified separately for each implementation function argument or collectively for all function arguments. For more information, see “Specify Data Alignment Requirements for Function Arguments” on page 23-121.
- 2 Specify the data alignment capabilities and syntax for one or more compilers, and include the alignment specifications in a CRL registry entry in an `sl_customization.m` or `rtwTargetInfo.m` file. For more information, see “Provide Data Alignment Specifications for Compilers” on page 23-123.
- 3 Register the CRL containing the table entry and the alignment specification object.

You can then select the CRL for your model, generate code, and observe the results.

For examples, see “Basic Example of CRL-Specified Data Alignment” on page 23-127 and the data alignment examples in the example `rtwdemo_crl_script`.

Specify Data Alignment Requirements for Function Arguments

To specify the data alignment requirement for an argument in a CRL replacement entry:

- If you are defining a replacement function in a CRL table definition file, you instantiate an object of class `RTW.ArgumentDescriptor`, use its `AlignmentBoundary` property to specify the required alignment boundary, and assign the `RTW.ArgumentDescriptor` object to the `Descriptor` property of the argument.
- If you are defining a replacement function using the Code Replacement Tool, you enter a value in the **Alignment value** parameter, which is located on the **Mapping Information** tab, within the **Argument properties** for the replacement function.

The screenshot shows a configuration window for a replacement function. It is divided into several sections:

- Function prototype:**
 - Name:
 - C++ namespace:
 - Function returns void
- Function arguments:** A list box containing 'y1(return arg)' and 'u1'. There are up and down arrow buttons next to the list.
- Argument properties:**
 - Data type:
 - I/O type:
 - Const
 - Pointer
 - Complex
 - Alignment value:

The `AlignmentBoundary` property (or **Alignment value** parameter) specifies the alignment boundary for data passed to a function argument, in number of bytes. The `AlignmentBoundary` property is valid only for addressable objects, including matrix and pointer arguments. It is not applicable for value arguments. Valid values are:

- -1 (default) — If the data is a `Simulink.Bus`, `Simulink.Signal`, or `Simulink.Parameter` object, specifies that the code generator should determine an optimal alignment based on usage. Otherwise, specifies that there is not an alignment requirement for this argument.
- Positive integer that is a power of 2, not exceeding 128 — Specifies number of bytes in the boundary. The starting memory address for the data allocated for the function argument will be a multiple of the specified value. If you specify an alignment boundary that is less than the natural alignment of the argument data type, the alignment directive is emitted in the generated code, but is silently ignored by the target compiler.

For example, the following code specifies the `AlignmentBoundary` for an argument as 16 bytes.

```
hLib = RTW.Tf1Table;
entry = RTW.Tf1COperationEntry;
arg = hLib.getTf1ArgFromString('u1','single*');
desc = RTW.ArgumentDescriptor;
desc.AlignmentBoundary = 16;
```



```
arg.Descriptor = desc;
entry.Implementation.addArgument(arg);
```

Here is the equivalent alignment boundary specification in the Code Replacement Tool dialog box:

The screenshot shows a dialog box titled "Argument properties". It contains the following fields and controls:

- Data type:** A dropdown menu with "single" selected.
- I/O type:** A dropdown menu with "INPUT" selected.
- Const:** An unchecked checkbox.
- Pointer:** A checked checkbox.
- Complex:** An unchecked checkbox.
- Alignment value:** A text input field containing the number "16".

Note If your model imports `Simulink.Bus`, `Simulink.Parameter`, or `Simulink.Signal` objects, you can specify an alignment boundary in the object properties, using the **Alignment** property. For more information, see the reference pages for `Simulink.Bus`, `Simulink.Parameter`, and `Simulink.Signal`.

Provide Data Alignment Specifications for Compilers

To support data alignment in generated code, you must describe the data alignment capabilities and syntax for your compiler(s) to the CRL registry. To do this, you provide one or more alignment specifications for each compiler in a CRL registry entry. For more information about CRL registry entries, see “Register Code Replacement Libraries” on page 23-203.

To describe the data alignment capabilities and syntax for a compiler:

- If you are defining a CRL registry entry in a `sl_customization.m` or `rtwTargetInfo.m` customization file, you add one or more `AlignmentSpecification` objects to an `RTW.DataAlignment` object, and attach the `RTW.DataAlignment` object to the `TargetCharacteristics` object of the CRL registry entry.

The `RTW.DataAlignment` object also has the property `DefaultMallocAlignment`, which specifies the default alignment boundary, in bytes, that the compiler uses for dynamically-allocated

memory. During code generation, if dynamic memory allocation is used for a data object involved in a code replacement, this value is used to determine if the dynamically allocated memory satisfies the alignment requirement of the replacement. If not, the replacement is disallowed. The default value for `DefaultMallocAlignment` is -1, indicating that the default alignment boundary used for dynamically-allocated memory is unknown. In this case, code generation uses the natural alignment of the data type to determine whether to allow a replacement.

- If you are generating a customization file function using the Code Replacement Tool, you fill out the following fields for each compiler:

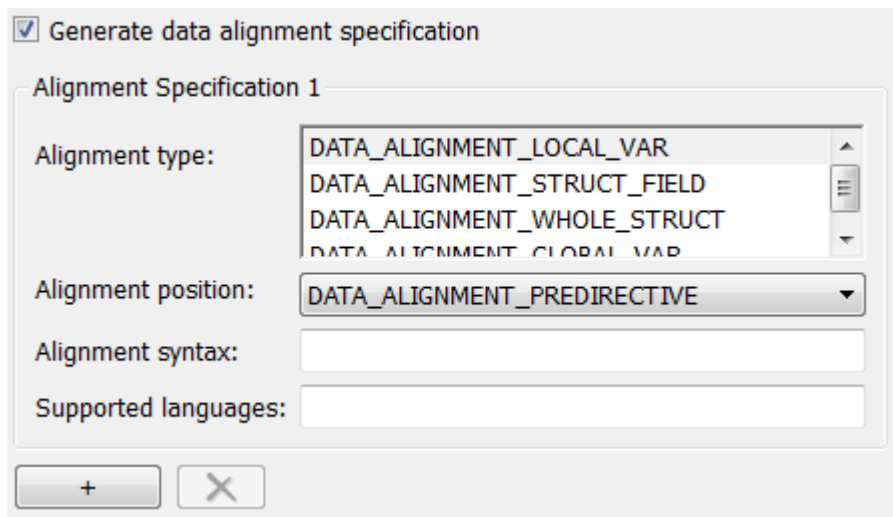

The screenshot shows a dialog box titled "Generate data alignment specification" with a checked checkbox. Below the title is a section labeled "Alignment Specification 1". It contains four fields: "Alignment type:" with a list box containing "DATA_ALIGNMENT_LOCAL_VAR", "DATA_ALIGNMENT_STRUCT_FIELD", "DATA_ALIGNMENT_WHOLE_STRUCT", and "DATA_ALIGNMENT_GLOBAL_VAR"; "Alignment position:" with a dropdown menu set to "DATA_ALIGNMENT_PREDIRECTIVE"; "Alignment syntax:" with an empty text box; and "Supported languages:" with an empty text box. At the bottom of the dialog are two buttons: a plus sign (+) and a close sign (X).

Click the plus (+) symbol to add additional compiler specifications.

For each data alignment specification, you provide the following information:

Alignment-Specification Property	Dialog Box Parameter	Description
AlignmentType	Alignment type	<p>Cell array of predefined enumerated strings, specifying which types of alignment are supported by this specification:</p> <ul style="list-style-type: none"> • <code>DATA_ALIGNMENT_LOCAL_VAR</code> — Local variables. • <code>DATA_ALIGNMENT_GLOBAL_VAR</code> — Global variables. • <code>DATA_ALIGNMENT_STRUCT_FIELD</code> — Individual structure fields. • <code>DATA_ALIGNMENT_WHOLE_STRUCT</code> — Whole structure, with padding (individual structure field alignment, if specified, is favored and takes precedence over whole structure alignment). <p>Each alignment specification must specify at least <code>DATA_ALIGNMENT_GLOBAL_VAR</code> and <code>DATA_ALIGNMENT_STRUCT_FIELD</code>.</p>
AlignmentPosition	Alignment position	<p>Predefined enumerated string specifying the position in which the compiler alignment directive should be placed for alignment type <code>DATA_ALIGNMENT_WHOLE_STRUCT</code>:</p> <ul style="list-style-type: none"> • <code>DATA_ALIGNMENT_PREDIRECTIVE</code> — The alignment directive is emitted before <code>struct st_tag{ }</code>, as part of the type definition statement (for example, MSVC). • <code>DATA_ALIGNMENT_POSTDIRECTIVE</code> — The alignment directive is emitted after <code>struct st_tag{ }</code>, as part of the type definition statement (for example, gcc). • <code>DATA_ALIGNMENT_PRECEDING_STATEMENT</code> — The alignment directive is emitted as a stand alone

Alignment-Specification Property	Dialog Box Parameter	Description
		<p>statement immediately preceding the definition of the structure type. The registered alignment syntax must be terminated by a semicolon (;).</p> <ul style="list-style-type: none"> • <code>DATA_ALIGNMENT_FOLLOWING_STATEMENT</code> — The alignment directive is emitted as a stand alone statement immediately following the definition of the structure type. The registered alignment syntax must be terminated by a semicolon (;). <p>For alignment types other than <code>DATA_ALIGNMENT_WHOLE_STRUCT</code>, code generation uses alignment position <code>DATA_ALIGNMENT_PREDIRECTIVE</code>.</p>
AlignmentSyntax-Template	Alignment syntax	<p>Specifies the alignment directive string that the compiler supports. The string is registered as a syntax template that has placeholders in it. The following placeholders are supported:</p> <ul style="list-style-type: none"> • <code>%n</code> — Replaced by the alignment boundary for the replacement function argument. • <code>%s</code> — Replaced by the symbol that will be aligned, usually the identifier of a variable. <p>For example, for the gcc compiler, you might specify <code>__attribute__((aligned(%n)))</code>, or for the MSVC compiler, <code>__declspec(align(%n))</code>.</p>
SupportedLanguages	Supported languages	<p>Cell array specifying the language(s) to which this alignment specification applies, among <code>c</code> and <code>c++</code>. Sometimes alignment syntax and position differ between languages for a compiler.</p>

For example, here is a data alignment specification for the GCC compiler:

```

da = RTW.DataAlignment;

as = RTW.AlignmentSpecification;
as.AlignmentType = {'DATA_ALIGNMENT_LOCAL_VAR', ...
                  'DATA_ALIGNMENT_STRUCT_FIELD', ...
                  'DATA_ALIGNMENT_GLOBAL_VAR'};
as.AlignmentSyntaxTemplate = '__attribute__((aligned(%n)))';
as.AlignmentPosition = 'DATA_ALIGNMENT_PREDIRECTIVE';
as.SupportedLanguages = {'c', 'c++'};
da.addAlignmentSpecification(as);

tc = RTW.TargetCharacteristics;
tc.DataAlignment = da;

```

Here is the corresponding specification in the Generate customization dialog box of the Code Replacement Tool:

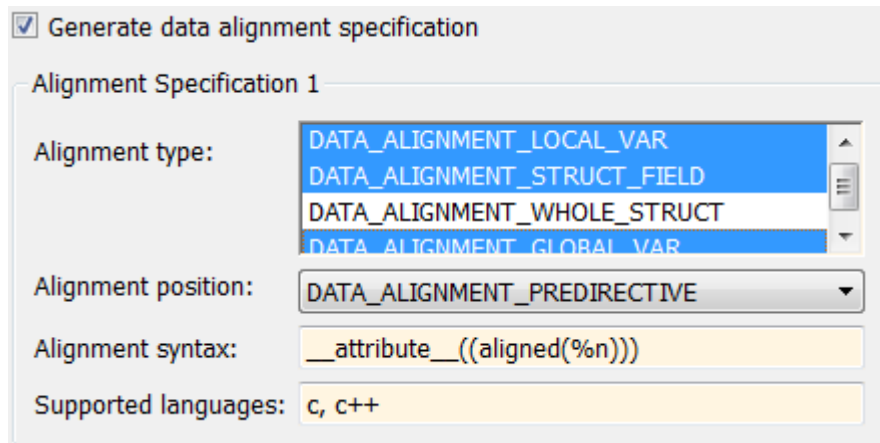

Basic Example of CRL-Specified Data Alignment

This section steps you through a simple example of the complete workflow for CRL-specified data alignment.

- 1 Create and save the following CRL table definition file, `crl_table_mmul_4x4_single_align.m`. This CRL table defines a replacement entry for the `*` (multiplication) operator, the `single` data type,

and input dimensions [4,4]. The entry also specifies a data alignment boundary of 16 bytes for each replacement function argument. This expresses the requirement that the starting memory address for the data allocated for the function arguments during code generation will be a multiple of 16.

```
function hLib = crl_table_mmul_4x4_single_align
%CRL_TABLE_MMUL_4x4_SINGLE_ALIGN - Describe matrix operator entry with data alignment

hLib = RTW.TflTable;
entry = RTW.TflCOperationEntry;
entry.setTflCOperationEntryParameters(...
    'Key',          'RTW_OP_MUL', ...
    'Priority',     90, ...
    'ImplementationName', 'matrix_mul_4x4_s');

% conceptual arguments
entry.createAndAddConceptualArg('RTW.TflArgMatrix',...
    'Name',        'y1', ...
    'IOType',      'RTW_IO_OUTPUT', ...
    'BaseType',    'single', ...
    'DimRange',    [4 4]);

entry.createAndAddConceptualArg('RTW.TflArgMatrix',...
    'Name',        'u1', ...
    'BaseType',    'single', ...
    'DimRange',    [4 4]);

entry.createAndAddConceptualArg('RTW.TflArgMatrix',...
    'Name',        'u2', ...
    'BaseType',    'single', ...
    'DimRange',    [4 4]);

% implementation arguments
arg = hLib.getTflArgFromString('y2', 'void');
arg.IOType = 'RTW_IO_OUTPUT';
entry.Implementation.Return=arg;

arg = hLib.getTflArgFromString('y1','single*');
desc = RTW.ArgumentDescriptor;
```

```

desc.AlignmentBoundary = 16;
arg.Descriptor = desc;
entry.Implementation.addArgument(arg);

arg = hLib.getTflArgFromString('u1', 'single*');
desc = RTW.ArgumentDescriptor;
desc.AlignmentBoundary = 16;
arg.Descriptor = desc;
entry.Implementation.addArgument(arg);

arg = hLib.getTflArgFromString('u2', 'single*');
desc = RTW.ArgumentDescriptor;
desc.AlignmentBoundary = 16;
arg.Descriptor = desc;
entry.Implementation.addArgument(arg);

hLib.addEntry(entry);

```

- 2** Create and save the following CRL registration file, `rtwTargetInfo.m`. If you intend to compile the code generated in this example, you can modify the `AlignmentSyntaxTemplate` property for the compiler you intend to use. For example, for the MSVC compiler, replace the gcc template string `__attribute__((aligned(%n)))` with `__declspec(align(%n))`.

```

function rtwTargetInfo(cm)
% rtwTargetInfo function to register a code replacement library (CRL)
% for use with code generation

% Register the CRL defined in local function locCrlRegFcn
cm.registerTargetInfo(@locCrlRegFcn);

end % End of RTWTARGETINFO

% Local function to define a CRL containing crl_table_mmul_4x4_single_align
function thisCrl = locCrlRegFcn

% create an alignment specification object, assume gcc
as = RTW.AlignmentSpecification;
as.AlignmentType = {'DATA_ALIGNMENT_LOCAL_VAR', ...
                   'DATA_ALIGNMENT_GLOBAL_VAR', ...

```

```

                                'DATA_ALIGNMENT_STRUCT_FIELD');
as.AlignmentSyntaxTemplate = '__attribute__((aligned(%n)))';
as.SupportedLanguages={'c', 'c++'};

% add the alignment specification object
da = RTW.DataAlignment;
da.addAlignmentSpecification(as);

% add the data alignment object to target characteristics
tc = RTW.TargetCharacteristics;
tc.DataAlignment = da;

% Instantiate a CRL registry entry
thisCr1 = RTW.Tf1Registry;

% Define the CRL properties
thisCr1.Name = 'Data Alignment Example';
thisCr1.Description = 'Example of replacement with data alignment';
thisCr1.TableList = {'crl_table_mmul_4x4_single_align'};
thisCr1.BaseTf1 = 'C89/C90 (ANSI)';
thisCr1.TargetCharacteristics = tc;

end % End of LOCCRLREGFCN

```

- 3 To register your CRL with code generation software without having to restart MATLAB, enter the following command in the MATLAB Command Window:

```
>> RTW.TargetRegistry.getInstance('reset');
```

- 4 Open an ERT-based Simulink model and go to the **Code Generation > Interface** pane of the Configuration Parameters dialog box. Verify that the **Code replacement library** option lists the CRL name you specified and select it.

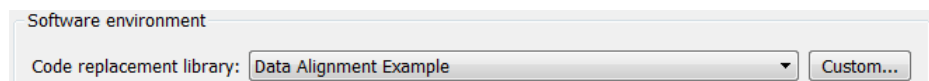

- 5 Create an ERT-based model with a Product block and configure the Product block for [4,4] matrix multiplication.

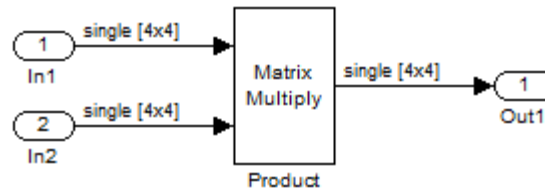

Check that the CRL you registered, Data Alignment Example, is selected for this model.

- 6 Go to the **Code Generation > Report** pane of the Configuration Parameters dialog box and select the options **Create code generation report** and **Model-to-code**. Then go to the **Code Generation** pane, select the **Generate code only** option, and generate code for the model.
- 7 Go to Simulink Editor and use model-to-code highlighting to trace the code generated using your CRL entry. For example, right-click the Product block and select **C/C++ Code > Navigate to C/C++ Code**. This selection highlights the Product function code within the model step function in `mmalign.c`. In this case, a multiplication operation has been replaced with a `matrix_mul_4x4_s` function call in the generated code.

```

30  /* Model step function */
31  void mmalign_step(void)
32  {
33  /* Product: '<Root>/Product' incorporates:
34   * Inport: '<Root>/In1'
35   * Inport: '<Root>/In2'
36   * Outport: '<Root>/Out1'
37   */
38  matrix_mul_4x4_s(*(real32_T (*) [16])&mmalign_Y.Out1[0], mmalign_U.In1,
39                  mmalign_U.In2);
40  }
  
```

Also, in `mmalign.h`, the gcc alignment directive `__attribute__((aligned(16)))` has been generated to align the function variables.

```
37  /* External inputs (root import signals with auto storage) */
38  typedef struct {
39      __attribute__((aligned(16))) real32_T In1[16];/* '<Root>/In1' */
40      __attribute__((aligned(16))) real32_T In2[16];/* '<Root>/In2' */
41  } ExternalInputs_mmalign;
42
43  /* External outputs (root outputs fed by signals with auto storage) */
44  typedef struct {
45      __attribute__((aligned(16))) real32_T Out1[16];/* '<Root>/Out1' */
46  } ExternalOutputs_mmalign;
```

Data Alignment Limitations

CRL data alignment has the following limitations:

- Complex data types are not supported.
- Software-in-the-loop (SIL) and Processor-in-the-loop (PIL) are not supported.
- Model reference parameters are not supported.
- For `Simulink.Bus`:
 - If structure field alignment is not supported by user registered alignment specifications, aligning `Simulink.Bus` objects is not supported unless the `Simulink.Bus` is imported.
 - When aligning a `Simulink.Bus` data object, the elements in the bus object will be aligned on the same boundary, which is the lowest common multiple of the alignment requirements for each individual bus element.
- When using the CRL data alignment feature for MATLAB Coder code generation, local variables in a MATLAB function will not be promoted to structure fields if the registered data alignment type specification does not support alignment of local variables. If a desired replacement of an operation on local variables cannot be aligned as required, the replacement does not occur, and code is generated as if the CRL replacement was not registered.
- Data alignment is not honored in code generation for shared utilities if the replacement would impose alignment requirements on the shared utility interface arguments. Under these conditions, replacement does not occur.

Replacement is allowed if the registered data alignment type specification supports alignment of local variables, and the replacement involves only local variables.

- Data alignment is not honored in code generation for a Stateflow graphical function if the function is exported; replacement does not occur.
- When alignment is specified for functions that occur in a model reference hierarchy, and the same function data is operated on by multiple models in the hierarchy, the bottommost model dictates the alignment for the rest of the hierarchy. If the alignment requirement for a function in a model higher in the hierarchy cannot be honored due to the alignment set by a model lower in the hierarchy, the replacement in the higher model does not occur (in some cases, an error message is generated). To work around this issue, if the shared data is represented by a bus or signal object, you can manually set the alignment property on the shared data by setting the alignment property of the `Simulink.Bus` or `Simulink.Signal` object.

Refine Matching and Replacement Using Custom Entries

- “Customize CRL Matching and Replacement for Operators” on page 23-135
- “Customize CRL Matching and Replacement for Functions” on page 23-144

During code generation for your model, the CRL replacement capability uses

- Preset match criteria to identify functions and operators for which target-specific implementations should replace default implementations
- Preset replacement function signatures

However, preset match criteria and preset replacement function signatures might not completely meet your function and operator replacement needs. For example,

- You might want to replace an operator with a particular fixed-point implementation function only when fraction lengths are within a particular range.

- When a match is made, you might want to modify your replacement function signature based on compile-time information, such as passing fraction-length values into the function.

When you need to add extra logic into the CRL matching and replacement process, you can create custom CRL table entries. Custom entries allow you to specify additional match criteria and/or modify the replacement function signature to meet your application needs.

To create a custom CRL table entry, you perform the following steps:

- 1** Create a custom CRL entry class, derived from either `RTW.Tf1COperationEntryML` (for operator replacement) or `RTW.Tf1CFunctionEntryML` (for function replacement).
- 2** In your derived class, implement a `do_match` method with a fixed preset signature as a MATLAB function. In your `do_match` method, you can provide either or both of the following customizations for use by CRL table entries that instantiate the class:
 - a** Add any additional match criteria not provided by the base class. The base class provides a match based on argument number, argument name, signedness, word size, slope (if not wildcarded), bias (if not wildcarded), math modes such as saturation and rounding, and operator or function key. For example, you can accept a match only when additional size or range conditions are met.
 - b** Modify the implementation signature by adding additional arguments or setting constant input argument values. For example, you can inject a constant value, such as an input's scaling value, as an additional argument to the replacement function.
- 3** Create CRL table entries that instantiate your custom CRL entry class.
- 4** Register a CRL containing the CRL table entries. The registered CRL is then available for selection in the **Code Generation > Interface** pane of the Simulink Configuration Parameters dialog box.

During code generation, the CRL matching process first tries to match function or operator call sites with the base class of your derived entry class. If a match is found, the software calls your `do_match` method to execute your

additional match logic (if any) and your replacement function customizations (if any).

The following sections provide examples of creating custom CRL table entries to refine matching and replacement for operators and functions. For more examples, see the CRL examples page, including the example model `rtwdemo_crlcustomentry`.

Customize CRL Matching and Replacement for Operators

This example demonstrates how to use custom CRL table entries to refine the matching and replacement logic for operators. In this example, a fixed-point addition replacement needs to be modified such that the implementation function passes in the fraction lengths of the input and output data types as arguments.

- 1 To exercise the custom CRL table entries created in this example, create an ERT-based model with one or more unsigned 32-bit fixed-point addition operations, such as the following:

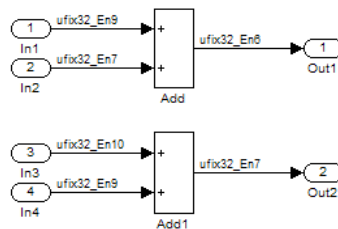

For the purposes of this example, in the block parameters for both Add blocks, set **Integer rounding mode** to **Floor** and select the option **Saturate on integer overflow**.

- 2 Create a class folder using the name of your derived class, such as `@Tf1CustomOperationEntry`. Check that the class folder is in the MATLAB search path or in the current working folder.
- 3 In the class folder, create and save the following class definition file, `Tf1CustomOperationEntry.m`. This file defines the class `Tf1CustomOperationEntry`, which is derived from the base class `RTW.Tf1COperationEntryML`

The derived class defines a `do_match` method . In the `do_match` method signature,

- `ent` is the return handle, which is returned either as empty (indicating that the match failed) or as a `Tf1COperationEntry` handle.
- `hThis` is the handle to this object.
- `hCSO` is a handle to an object created by the code generator for the purpose of querying the CRL for a replacement.
- The remaining arguments are the number of bits for various data types of the current target.

The purpose of the `do_match` method is to add any required additional match criteria not provided by the base class and make any required modifications to the implementation signature. In this case, the `do_match` method can rely on the base class for checking word size and signedness, and additionally only needs to match the number of conceptual arguments to the value 3 (two inputs and one output) and the bias for each argument to the value 0. If a match is made, the method sets the return handle, removes slope and bias wildcarding from the conceptual arguments (since the match is for specific slope and bias values), and writes fraction-length values for the inputs and output into replacement function arguments 3, 4, and 5.

Note The three additional implementation function arguments for passing fraction lengths can be created and added either here in the class definition or in each CRL table entry definition that instantiates this class. In this example, the arguments are created and added in a CRL table definition file and set to specific values in the class definition code. For an example of creating and adding additional implementation function arguments in a class definition, see “Customize CRL Matching and Replacement for Functions” on page 23-144.

```
classdef Tf1CustomOperationEntry < RTW.Tf1COperationEntryML
    methods
        function ent = do_match(hThis, ...
            hCSO, ... %#ok
            targetBitPerChar, ... %#ok
            targetBitPerShort, ... %#ok
```

```

        targetBitPerInt, ... %#ok
        targetBitPerLong) %#ok
% DO_MATCH - Create a custom match function. The base class
% checks the types of the arguments prior to calling this
% method. This will check additional data and perhaps modify
% the implementation function.

% The base class checks word size and signedness. Slopes and biases
% have been wildcarded, so the only additional checking to do is
% to check that the biases are zero and that there are only three
% conceptual arguments (one output, two inputs)

ent = []; % default the return to empty, indicating the match failed.

if length(hCSO.ConceptualArgs) == 3 && ...
    hCSO.ConceptualArgs(1).Type.Bias == 0 && ...
    hCSO.ConceptualArgs(2).Type.Bias == 0 && ...
    hCSO.ConceptualArgs(3).Type.Bias == 0

% Modify the default implementation. Since this is a
% generator entry, a concrete entry is created using this entry
% as a template. The type of entry being created is a standard
% TfLCOperationEntry. Using the standard operation entry
% provides the necessary information, and you do not need
% a custom match function.
ent = RTW.TfLCOperationEntry(hThis);

% Since this entry is modifying the implementation for specific
% fraction-length values (arguments 3, 4, and 5), the conceptual argument
% wildcards must be removed (the wildcards were inherited from the
% generator when it was used as a template for the concrete entry).
% This concrete entry is now for a specific slope and bias
% (not for any slope and bias). The hCSO holds the
% slope and bias values (created by the code generator).
for idx=1:3
    ent.ConceptualArgs(idx).CheckSlope = true;
    ent.ConceptualArgs(idx).CheckBias = true;

% Set the specific Slope and Biases
ent.ConceptualArgs(idx).Type.Slope = hCSO.ConceptualArgs(idx).Type.Slope;

```

```
        ent.ConceptualArgs(idx).Type.Bias = 0;
    end

    % Set the fraction-length values in the implementation function.
    ent.Implementation.Arguments(3).Value = ...
        -1.0*hCS0.ConceptualArgs(2).Type.FixedExponent;
    ent.Implementation.Arguments(4).Value = ...
        -1.0*hCS0.ConceptualArgs(3).Type.FixedExponent;
    ent.Implementation.Arguments(5).Value = ...
        -1.0*hCS0.ConceptualArgs(1).Type.FixedExponent;
end
end
end
end
```

Exit the class folder and return to the previous working folder.

- 4** Create and save the following CRL table definition file, `crl_table_custom_add_ufix32.m`. This file defines a CRL table containing a single operator entry, a CRL entry generator for unsigned 32-bit fixed-point addition operations, with arbitrary fraction-length values on the inputs and the output. This entry instantiates the derived class from the previous step, `Tf1CustomOperationEntry`.

Note

- If you want to replace all word sizes and signedness attributes (not just 32-bit and unsigned), you can use the same derived class, but not the same CRL entry, because the `WordLength` and `IsSigned` arguments cannot be wildcarded. For example, to support `uint8`, `int8`, `uint16`, `int16`, and `int32`, you would need to add five other distinct CRL entries. Similarly, if you wanted to use different implementation functions for saturation and rounding modes other than overflow and round to floor, you would need to add CRL entries for those match permutations.
- This table entry creates and adds three implementation arguments to hold the fraction-length values for the inputs and output. Alternatively, this table entry could omit those argument definitions and instead the `do_match` method of the derived class `Tf1CustomOperationEntry` could create and add the three implementation arguments. In particular, you should use the alternative approach when the number of additional implementation arguments required might vary based on compile-time information.

```
function hTable = crl_table_custom_add_ufix32

hTable = RTW.Tf1Table;

%% Add Tf1CustomOperationEntry
op_entry = Tf1CustomOperationEntry;
setTf1COperationEntryParameters(op_entry, ...
    'Key', 'RTW_OP_ADD', ...
    'Priority', 30, ...
    'SaturationMode', 'RTW_SATURATE_ON_OVERFLOW', ...
    'RoundingModes', {'RTW_ROUND_FLOOR'}, ...
    'ImplementationName', 'myFixptAdd', ...
    'ImplementationHeaderFile', 'myFixptAdd.h', ...
    'ImplementationSourceFile', 'myFixptAdd.c');

createAndAddConceptualArg(op_entry, 'RTW.Tf1ArgNumeric', ...
    'Name', 'y1', ...
    'IOType', 'RTW_IO_OUTPUT', ...
    'CheckSlope', false, ...
```

```
        'CheckBias', false, ...
        'DataType',  'Fixed', ...
        'Scaling',   'BinaryPoint', ...
        'IsSigned',  false, ...
        'WordLength', 32);

createAndAddConceptualArg(op_entry, 'RTW.Tf1ArgNumeric', ...
    'Name',      'u1', ...
    'IOType',    'RTW_IO_INPUT', ...
    'CheckSlope', false, ...
    'CheckBias', false, ...
    'DataType',  'Fixed', ...
    'Scaling',   'BinaryPoint', ...
    'IsSigned',  false, ...
    'WordLength', 32);

createAndAddConceptualArg(op_entry, 'RTW.Tf1ArgNumeric', ...
    'Name',      'u2', ...
    'IOType',    'RTW_IO_INPUT', ...
    'CheckSlope', false, ...
    'CheckBias', false, ...
    'DataType',  'Fixed', ...
    'Scaling',   'BinaryPoint', ...
    'IsSigned',  false, ...
    'WordLength', 32);

% Specify replacement function signature
createAndSetCImplementationReturn(op_entry, 'RTW.Tf1ArgNumeric', ...
    'Name',      'y1', ...
    'IOType',    'RTW_IO_OUTPUT', ...
    'IsSigned',  false, ...
    'WordLength', 32, ...
    'FractionLength', 0);

createAndAddImplementationArg(op_entry, 'RTW.Tf1ArgNumeric', ...
    'Name',      'u1', ...
    'IOType',    'RTW_IO_INPUT', ...
    'IsSigned',  false, ...
    'WordLength', 32, ...
    'FractionLength', 0);
```

```

createAndAddImplementationArg(op_entry, 'RTW.Tf1ArgNumeric', ...
    'Name',      'u2', ...
    'IOType',    'RTW_IO_INPUT', ...
    'IsSigned',  false, ...
    'WordLength', 32, ...
    'FractionLength', 0);

% Add 3 fraction-length args. Actual values will be set during code generation.
createAndAddImplementationArg(op_entry, 'RTW.Tf1ArgNumericConstant', ...
    'Name',      'f1_in1', ...
    'IOType',    'RTW_IO_INPUT', ...
    'IsSigned',  false, ...
    'WordLength', 32, ...
    'FractionLength', 0, ...
    'Value',     0);

createAndAddImplementationArg(op_entry, 'RTW.Tf1ArgNumericConstant', ...
    'Name',      'f1_in2', ...
    'IOType',    'RTW_IO_INPUT', ...
    'IsSigned',  false, ...
    'WordLength', 32, ...
    'FractionLength', 0, ...
    'Value',     0);

createAndAddImplementationArg(op_entry, 'RTW.Tf1ArgNumericConstant', ...
    'Name',      'f1_out', ...
    'IOType',    'RTW_IO_INPUT', ...
    'IsSigned',  false, ...
    'WordLength', 32, ...
    'FractionLength', 0, ...
    'Value',     0);

addEntry(hTable, op_entry);

```

- 5** Optionally, perform a quick check of the validity of the function entry by invoking the table definition file at the MATLAB command line (>> `tbl = crl_table_custom_add_ufix32`) and by viewing it in the Code Replacement Viewer (>> `RTW.viewTf1(crl_table_custom_add_ufix32)`).

For more information about validating CRL tables, see “Examine and Validate Code Replacement Tables” on page 23-191.

- 6 Create and save the following CRL registration file, which references the `crl_table_custom_add_ufix32` table.

The file specifies that the CRL to be registered is named `Custom CRL Operator Entry Example` and consists of `crl_table_custom_add_ufix32`, with the default ANSI math library as the base CRL table.

```
function sl_customization(cm)
% sl_customization function to register a code replacement library (CRL)

% Register the CRL defined in local function locCrlRegFcn
cm.registerTargetInfo(@locCrlRegFcn);

end % End of SL_CUSTOMIZATION

% Local function to define a CRL containing crl_table_custom_add_ufix32
function thisCrl = locCrlRegFcn

% Instantiate a CRL registry entry
thisCrl = RTW.Tf1Registry;

% Define the CRL properties
thisCrl.Name = 'Custom CRL Operator Entry Example';
thisCrl.Description = 'Example of custom match for operator replacement';
thisCrl.TableList = {'crl_table_custom_add_ufix32'};
thisCrl.BaseTf1 = 'C89/C90 (ANSI)';
thisCrl.TargetHWDeviceType = {'*'};

end % End of LOCCRLREGFCN
```

Place this `sl_customization.m` file in the MATLAB search path or in the current working folder, so that the CRL is registered at each Simulink startup.

Tip To refresh Simulink customizations within the current MATLAB session, use the command `sl_refresh_customizations`. To refresh MATLAB Coder CRL registration information within a MATLAB session, use the command `RTW.TargetRegistry.getInstance('reset');`

For more information about registering CRLs with Simulink or MATLAB Coder software, see “Register Code Replacement Libraries” on page 23-203.

- 7 With your `sl_customization.m` file in the MATLAB search path or in the current working folder, open the model you created in step 1 and go to the **Code Generation > Interface** pane of the Configuration Parameters dialog box. Verify that the **Code replacement library** option lists the CRL name you specified and select it.

Optionally, you can relaunch the Code Replacement Viewer, using the MATLAB command `RTW.viewTFL` without arguments, to examine the currently registered CRLs, including Custom CRL Operator Entry Example.

- 8 Go to the **Code Generation > Report** pane of the Configuration Parameters dialog box and select the options **Create code generation report** and **Model-to-code**. Then go to the **Code Generation** pane, select the **Generate code only** option, and generate code for the model.
- 9 Go to Simulink Editor and use model-to-code highlighting to trace the code generated using your CRL entry. For example, right-click either Add block and select **C/C++ Code > Navigate to C/C++ Code**. This selection highlights the Sum block code within the model step function in the `model.c` file. As shown below, the default implementation code for the unsigned 32-bit fixed-point addition operation has been replaced with `myFixptAdd`, and the three additional fraction-length arguments are present.

```
/* Model step function */
void ufix32_add_step(void)
{
    /* Output: '<Root>/Out1' incorporates:
     * Inport: '<Root>/In1'
     * Inport: '<Root>/In2'
```

```

* Sum: '<Root>/Add'
*/
ufix32_add_Y.Out1 = myFixptAdd(ufix32_add_U.In1, ufix32_add_U.In2, 9U, 7U, 6U);

/* Output: '<Root>/Out2' incorporates:
* Inport: '<Root>/In3'
* Inport: '<Root>/In4'
* Sum: '<Root>/Add1'
*/
ufix32_add_Y.Out2 = myFixptAdd(ufix32_add_U.In3, ufix32_add_U.In4, 10U, 9U, 7U);
}

```

Customize CRL Matching and Replacement for Functions

This example demonstrates how to use custom CRL table entries to refine the matching and replacement logic for functions. In this example, a sine function replacement needs to be modified, only if the integer size on the current target platform is 32 bits, such that the implementation function passes in a degrees-versus-radians flag as an input argument.

- 1 To exercise the custom CRL table entries created in this example, create an ERT-based model with a sine function block, such as the following:

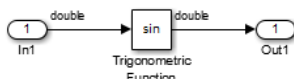

For the purposes of this example, in the import block parameters, set the signal **Data type** to double. Also, if the target platform selected for your model on the **Hardware Implementation** pane of the Configuration Parameters dialog box supports an integer size other than 32, you should either temporarily select a target platform with a 32-bit integer size, or modify the code in this example to match the integer size of your target platform.

- 2 Create a class folder using the name of your derived class, such as @Tf1CustomFunctionEntry. Check that the class folder is in the MATLAB search path or in the current working folder.

- 3** In the class folder, create and save the following class definition file, `Tf1CustomFunctionEntry.m`. This file defines the class `Tf1CustomFunctionEntry`, which is derived from the base class `RTW.Tf1CFunctionEntryML`

The derived class defines a `do_match` method . In the `do_match` method signature,

- `ent` is the return handle, which is returned either as empty (indicating that the match failed) or as a `Tf1CFunctionEntry` handle.
- `hThis` is the handle to this object.
- `hCSO` is a handle to an object created by the code generator for the purpose of querying the CRL for a replacement.
- The remaining arguments are the number of bits for various data types of the current target.

The purpose of the `do_match` method is to add any required additional match criteria not provided by the base class and make any required modifications to the implementation signature. In this case, the `do_match` method only needs to match `targetBitPerInt`, representing the number of bits in the `C int` data type for the current target, to the value 32. If a match is made, the method sets the return handle and creates and adds an input argument, representing whether units are expressed as degrees or radians, to the replacement function signature.

Note Alternatively, the additional implementation function argument for passing a units flag could be created and added in each CRL table definition file that instantiates this class. In that case, this class definition code would not create the argument and would only set its value. For an example of creating and adding additional implementation function arguments in a table definition file, see “Customize CRL Matching and Replacement for Operators” on page 23-135.

```
classdef Tf1CustomFunctionEntry < RTW.Tf1CFunctionEntryML
    methods
        function ent = do_match(hThis, ...
            hCSO, ... %#ok
```

```

        targetBitPerChar, ... %#ok
        targetBitPerShort, ... %#ok
        targetBitPerInt, ... %#ok
        targetBitPerLong) %#ok
% DO_MATCH - Create a custom match function. The base class
% checks the types of the arguments prior to calling this
% method. This will check additional data and perhaps modify
% the implementation function.

ent = []; % default the return to empty, indicating the match failed.

% Match sine function only if the target int size is 32 bits
if targetBitPerInt == 32
    % Need to modify the default implementation, starting from a copy
    % of the standard TflCFunctionEntry.
    ent = RTW.TflCFunctionEntry(hThis);

    % If the target int size is 32 bits, the implementation function
    % takes an additional input flag argument indicating degrees vs.
    % radians. The additional argument can be created and added either
    % in the CRL table definition file that instantiates this class, or
    % here in the class definition, as follows:
    createAndAddImplementationArg(ent, 'RTW.TflArgNumericConstant', ...
                                    'Name',          'u2', ...
                                    'IsSigned',       true, ...
                                    'WordLength',     32, ...
                                    'FractionLength', 0, ...
                                    'Value',         1);
end
end
end
end
end

```

Exit the class folder and return to the previous working folder.

- 4 Create and save the following CRL table definition file, `crl_table_custom_sinfcn_double.m`. This file defines a CRL table containing a function table entry for sine with double input and output. This entry instantiates the derived class from the previous step, `TflCustomFunctionEntry`.

```

function hTable = crl_table_custom_sinfcn_double

hTable = RTW.Tf1Table;

%% Add Tf1CustomFunctionEntry
fcn_entry = Tf1CustomFunctionEntry;
setTf1CFunctionEntryParameters(fcn_entry, ...
    'Key', 'sin', ...
    'Priority', 30, ...
    'ImplementationName', 'mySin', ...
    'ImplementationHeaderFile', 'mySin.h', ...
    'ImplementationSourceFile', 'mySin.c');

createAndAddConceptualArg(fcn_entry, 'RTW.Tf1ArgNumeric', ...
    'Name', 'y1', ...
    'IOType', 'RTW_IO_OUTPUT', ...
    'DataTypeMode', 'double');

createAndAddConceptualArg(fcn_entry, 'RTW.Tf1ArgNumeric', ...
    'Name', 'u1', ...
    'IOType', 'RTW_IO_INPUT', ...
    'DataTypeMode', 'double');

% Tf1CustomFunctionEntry class do_match method will create and add
% an implementation function argument during code generation if
% the supported integer size on the current target is 32 bits.
copyConceptualArgsToImplementation(fcn_entry);

addEntry(hTable, fcn_entry);

```

- 5** Optionally, perform a quick check of the validity of the function entry by invoking the table definition file at the MATLAB command line (`>> tbl = crl_table_custom_sinfcn_double`) and by viewing it in the Code Replacement Viewer (`>> RTW.viewTf1(crl_table_custom_sinfcn_double)`). For more information about validating CRL tables, see “Examine and Validate Code Replacement Tables” on page 23-191.
- 6** Create and save the following CRL registration file, which references the `crl_table_custom_sinfcn_double` table.

The file specifies that the CRL to be registered is named 'Custom CRL Function Entry Example' and consists of `cr1_table_custom_sinfcn_double`, with the default ANSI math library as the base CRL table.

```
function sl_customization(cm)
% sl_customization function to register a code replacement library (CRL)

    % Register the CRL defined in local function locCrlRegFcn
    cm.registerTargetInfo(@locCrlRegFcn);

end % End of SL_CUSTOMIZATION

% Local function to define a CRL containing cr1_table_custom_sinfcn_double
function thisCrl = locCrlRegFcn

    % Instantiate a CRL registry entry
    thisCrl = RTW.Tf1Registry;

    % Define the CRL properties
    thisCrl.Name = 'Custom CRL Function Entry Example';
    thisCrl.Description = 'Example of custom match for function replacement';
    thisCrl.TableList = {'cr1_table_custom_sinfcn_double'};
    thisCrl.BaseTf1 = 'C89/C90 (ANSI)';
    thisCrl.TargetHWDeviceType = {'*'};

end % End of LOCCRLREGFCN
```

Place this `sl_customization.m` file in the MATLAB search path or in the current working folder, so that the CRL is registered at each Simulink startup.

Tip To refresh Simulink customizations within the current MATLAB session, use the command `sl_refresh_customizations`. To refresh MATLAB Coder CRL registration information within a MATLAB session, use the command `RTW.TargetRegistry.getInstance('reset');`

For more information about registering CRLs with Simulink or MATLAB Coder software, see “Register Code Replacement Libraries” on page 23-203.

- 7 With your `sl_customization.m` file in the MATLAB search path or in the current working folder, open the model you created in step 1 and go to the **Code Generation > Interface** pane of the Configuration Parameters dialog box. Verify that the **Code replacement library** option lists the CRL name you specified and select it.

Optionally, you can relaunch the Code Replacement Viewer, using the MATLAB command `RTW.viewTFL` without arguments to examine the currently registered CRLs, including Custom CRL Function Entry Example.

- 8 Go to the **Code Generation > Report** pane of the Configuration Parameters dialog box and select the options **Create code generation report** and **Model-to-code**. Then go to the **Code Generation** pane, select the **Generate code only** option, and generate code for the model.
- 9 Go to Simulink Editor and use model-to-code highlighting to trace the code generated using your CRL entry. For example, right-click the sine block and select **C/C++ Code > Navigate to C/C++ Code**. This selection highlights the sine block code within the model step function in the `model.c` file. As shown below, the default implementation code for the sine function has been replaced with `mySin`, and the additional units flag input argument is present.

```

/* Model step function */
void sine_double_step(void)
{
    /* Output: '<Root>/Out1' incorporates:
    * Inport: '<Root>/In1'
    * Trigonometry: '<Root>/Trigonometric Function'
    */
    sine_double_Y.Out1 = mySin(sine_double_U.In1, 1);
}

```

Note Optionally, you can change the current target for the model such that the supported integer size is not 32 bits, and then regenerate code. In that case, the custom match is not made, and the additional input argument does not appear in the generated code for the sine block.

Replace Math Functions Based on Computation Method

Certain math function blocks are configured with computation or approximation methods that you can use as distinguishing attributes to control CRL-based code replacement. For example,

- You can configure the Reciprocal Sqrt block to use either of two computation methods, Newton-Raphson or Exact.
- You can configure the Trigonometric Function block, with **Function** set to `sin`, `cos`, or `sincos`, to use either of two approximation methods, `CORDIC` or `None`.

You can define CRL table entries to replace these functions for one or all of the available computation methods. For example, you could provide a table entry to replace only Newton-Raphson instances of the `rSqrt` function.

To distinguish between computation methods for a given function, use the `EntryInfoAlgorithm` property of CRL function entries in a call to the `setTf1cFunctionEntryParameters` function. The arguments for specifying the computation method to match during code generation are:

- For `rSqrt`:
 - `'RTW_DEFAULT'` (match the default computation method, `Exact`)
 - `'RTW_NEWTON_RAPHSON'`
 - `'RTW_UNSPECIFIED'` (match any computation method)
- For `sin`, `cos`, or `sincos`:
 - `'RTW_CORDIC'`
 - `'RTW_DEFAULT'` (match the default approximation method, `None`)

- 'RTW_UNSPECIFIED' (match any approximation method)

For example, to replace only Newton-Raphson instances of the rSqrt function, you can create a table entry similar to the following.

```
hLib = RTW.TflTable;

%
% real_T rsqrt(real_T)
%

e = RTW.TflFunctionEntry;
setTflFunctionEntryParameters(e, ...
    'Key', 'rSqrt', ...
    'Priority', 80, ...
    'ImplementationName', 'rsqrt_newton', ...
    'ImplementationHeaderFile', 'rsqrt.h', ...
    'EntryInfoAlgorithm', 'RTW_NEWTON_RAPHSON'');
createAndAddConceptualArg(e, 'RTW.TflArgNumeric', ...
    'Name', 'y1', ...
    'IOType', 'RTW_IO_OUTPUT', ...
    'DataTypeMode', 'double');
createAndAddConceptualArg(e, 'RTW.TflArgNumeric', ...
    'Name', 'u1', ...
    'DataTypeMode', 'double');
copyConceptualArgsToImplementation(e);
addEntry(hLib, e);
```

The generated code for a Newton-Raphson instance of the rSqrt function resembles the following:

```
/* Model step function */
void mrsqrt_step(void)
{
    /* Output: '<Root>/Out1' incorporates:
     *   Inport: '<Root>/In1'
     *   Sqrt: '<Root>/rSqrtBlk'
     */
    mrsqrt_Y.Out1 = rsqrt_newton(mrsqrt_U.In1);
}
```

Map Semaphore or Mutex Operations to Target-Specific Implementations

The Embedded Coder software supports the following semaphore and mutex operations for replacement with custom library functions using code replacement library (CRL) tables.

Operation	Key
Mutex Destroy	RTW_MUTEX_DESTROY
Mutex Init	RTW_MUTEX_INIT
Mutex Lock	RTW_MUTEX_LOCK
Mutex Unlock	RTW_MUTEX_UNLOCK
Semaphore Destroy	RTW_SEM_DESTROY
Semaphore Init	RTW_SEM_INIT
Semaphore Post	RTW_SEM_POST
Semaphore Wait	RTW_SEM_WAIT

Note Semaphore and mutex code replacement is supported for:

- Simulink code generation for data transfer between tasks
- Code generation targets

Semaphore and mutex code replacement is *not* supported for:

- Stateflow charts, MATLAB Function blocks, and MATLAB functions
 - Simulation targets
-

MathWorks provides code replacement tables that support semaphore and mutex replacement for Windows, Linux, Mac, and VxWorks platforms. You can use the `RTW.viewTf1` command to open a base CRL, such as `C89/C90` (ANSI), and view the operating system specific definitions for the semaphore and mutex replacements. If you are authoring or maintaining a custom

target that supports concurrent execution, and you want to provide custom implementations of semaphore or mutex operations, you create a code replacement table with four semaphore entries, four mutex entries, or both, and include the table in a custom CRL. (The semaphore or mutex entries are mutually dependent and must be provided in complete sets of four.)

Note A custom target that supports concurrent multitasking must set the target configuration parameter `ConcurrentExecutionCompliant`. For more information, see “Support Concurrent Execution of Multiple Tasks” in the Simulink Coder documentation.

During code generation for a multicore target environment, if the build process generates semaphore or mutex function calls for data transfer between tasks, you can use a custom CRL to replace the generated function calls with custom semaphore or mutex implementations that are optimal for your target environment. Using the Code Replacement Tool (`crtool`) or equivalent CRL functions, you can:

- Configure CRL table entries for custom semaphore or mutex functions to be called during system startup, during execution of the code for data transfer between tasks, and during system shutdown.
- Configure `DWork` arguments that represent global data accessed by the semaphore or mutex functions. A `DWork` pointer is passed to the model entry functions.

Generated semaphore or mutex code typically consists of the following:

- In model initialization code, a semaphore or mutex initialization function call to create a semaphore or mutex to control entry to a critical code section.
- In model step code:
 - Semaphore wait or mutex lock function calls to reserve the semaphore or mutex before code for data transfer between tasks enters the critical section.
 - Semaphore post or mutex unlock function calls to release the semaphore or mutex after the data transfer code has finished executing the critical section.

- In model termination code, a semaphore or mutex destroy function to explicitly delete the semaphore or mutex during model termination (optional).

The following example shows how to create CRL table entries for a mutex replacement scenario. In this scenario, a multicore target model is configured for concurrent execution and for data transfer between tasks of differing rates, which are handled by Rate Transition blocks. In the generated code for the model, each Rate Transition block has a separate, unique mutex. Mutex lock and unlock operations within Rate Transition block generated code share access to the same global data via the unique mutex created for that Rate Transition block.

- 1** Open the Code Replacement Tool. For example, enter the MATLAB command `crtool`.
- 2** Create and open a new CRL table. In the Code Replacement dialog box, select **File > New table**.
- 3** Name the table. In the right-most pane of the dialog box, in the **Name** field, enter a name such as `crl_table_rt_mutex`.
- 4** First, create a table entry for a mutex initialization function replacement.
 - a** Select **File > New entry > Semaphore entry**. This action opens a new table entry for configuring a semaphore or mutex replacement.
 - b** In the **Mapping Information** tab, use the **Function** parameter to select `Mutex Init`. Initial default values for the table entry are displayed. In the **Conceptual function** section, typically you can leave the argument settings at their defaults.
 - c** In the **DWork attributes** section, the **Allocate DWork** option is selected, and the dialog box provides a unique entry tag for the DWork argument `d1`.

DWork attributes

Allocate DWork

DWork argument

Entry tag (unique):

DWork arguments

Argument properties

Data type: Pointer

The **DWork attributes** pane allows you to configure a DWork argument to the replacement function. The DWork argument supports sharing of a semaphore or mutex between code that creates the semaphore or mutex, code that requests and relinquishes access, and code that deletes the semaphore or mutex. In this example, the DWork argument for the `Mutex Init` function defines a unique entry tag (autogenerated by the dialog box), `entry_25576`, and the DWork arguments for `Mutex Lock`, `Mutex Unlock`, and `Mutex Destroy` reference the entry tag to share the DWork data.

The only data type supported for the DWork **Data type** parameter is `void*`.

- d** In the **Replacement function** section, **Name** field, enter a function name. This example uses `myMutexCreate`. In the list of **Function arguments**, leave the DWork argument `d1` data type as `void**`.

Replacement function

Function prototype

Name: C++ namespace:

Function returns void

Function arguments

Argument properties

Data type: I/O type:

Const Pointer Pointer-Pointer

Function signature preview

`void myMutexCreate (void** d1);`

The function signature preview now shows `void myMutexCreate (void** d1);`.

- e** In the **Replacement function** section, select the option **Function modifies internal or global state**. This flags the code generator that the implementation function described by this entry should not be optimized away, because it accesses global memory values. Click **Apply**. Optionally, you can click **Validate entry** to validate the information entered in the **Mapping Information** tab.

Note For the purposes of creating a sample CRL table entry, you can configure the replacement function signature without the replacement function and its build information being present. However, if header and source files for the implementation functions are available, you can select the **Build Information** tab and specify them.

- f** The `Mutex Init` table entry is complete. Optionally, you can save the table to a file, and inspect the MATLAB code created for the table definition so far.
- 5** Repeat the following sequence to create the table entries for the mutex lock, unlock, and destroy function replacements. Each table entry references the `DWork` unique tag entry, `entry_25576`, defined in the `Mutex Init` table entry.

- a Select **File > New entry > Semaphore entry**.
- b In the **Mapping Information** tab, use the **Function** parameter to select **Mutex Lock**, **Mutex Unlock**, or **Mutex Destroy**. Initial default values for the table entry are displayed. In the **Conceptual function** section, typically you can leave the argument settings at their defaults.
- c For a Rate Transition block mutex, the wait, post, and destroy functions operate on the DWork allocated at system startup by the mutex initialization function. In the **DWork attributes** section, check that the **Allocate DWork** option is cleared. From the **DWork Allocator entry** drop-down list, select the entry tag matching the value in the **Mutex Init** table entry, which in this example is **entry_25576**.

DWork attributes

Allocate DWork

DWork Allocator entry:

- d In the **Replacement function** section, **Name** field, enter a function name. This example uses **myMutexLock**, **myMutexUnlock**, and **myMutexDelete**. In the list of **Function arguments**, leave the DWork argument **d1** data type as **void***.

Replacement function

Function prototype

Name: C++ namespace:

Function returns void

Function arguments

y1(return arg)
d1

Argument properties

Data type: I/O type:

Const Pointer Pointer-Pointer

Alignment value:

Function signature preview

```
void myMutexLock(void* d1);
```

- e In the **Replacement function** section, select the option **Function modifies internal or global state**. This flags the code generator that the implementation function described by this entry should not be optimized away, because it accesses global memory values.
 - f Optionally, supply replacement function build information on the **Build Information** tab.
 - g Click **Apply**. In the middle pane, right-click the table entry and select **Validate entry(s)**.
- 6 When you have added the table entries for `Mutex Lock`, `Mutex Unlock`, and `Mutex Destroy` to the entry for `Mutex Init`, the rate transition mutex replacement table is complete. In the left-most pane, right-click the table name and select **Validate table**. If errors are flagged, address the errors and repeat the table validation.

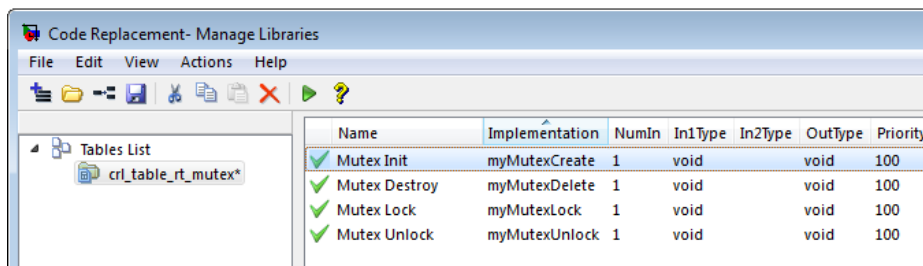

- 7 Save the table to a MATLAB file in your working folder, for example, using **File > Save table**. The name of the saved file is the table name, `crl_table_rt_mutex`, with an `.m` extension. Optionally, you can open the saved file and examine the MATLAB code for the CRL table definition
- 8 Create a CRL registration file, `rtwTargetInfo.m`, that includes your code replacement table. Select **File > Generate registration file** to open the Generate registration file dialog box. Edit the dialog box fields to match the following figure:

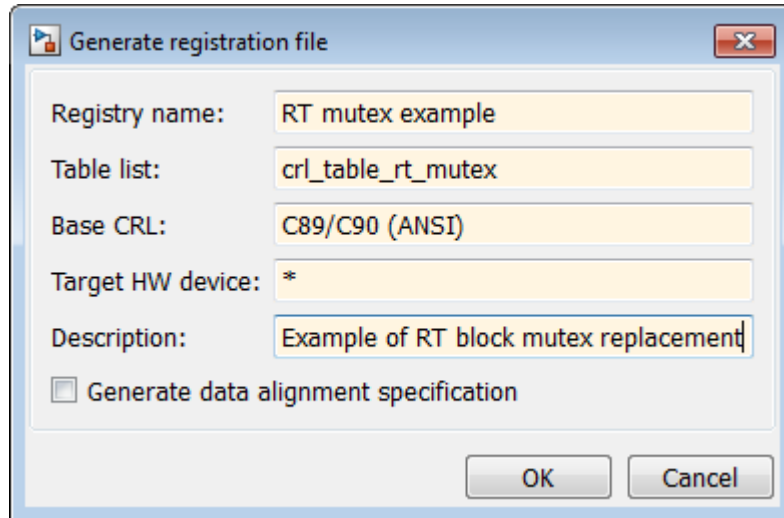

Click **OK**. The Select location dialog box opens. Use the dialog box to specify a location for the registration file. The location must be on the MATLAB path or in the current working folder. Save the file. Optionally, you can open the generated file and examine the MATLAB code for the CRL registry entry.

- 9 To register your CRL with code generation software without having to restart MATLAB, enter the following MATLAB command:

```
>> RTW.TargetRegistry.getInstance('reset');
```

- 10 Open an ERT-based Simulink model, configured for a multicore target environment, that contains a rate transition for which the build process generates mutex function calls. This example uses the following model.



- 11 Go to the **Code Generation > Interface** pane of the Configuration Parameters dialog box. Verify that the **Code replacement library**

parameter lists the CRL that you registered, RT mutex example, and select it.

- 12 Go to the **Code Generation > Report** pane of the Configuration Parameters dialog box. Select the options **Create code generation report**, **Open report automatically**, **Model-to-code**, and **Summarize which block triggered code replacements**. Then go to the **Code Generation** pane, select the **Generate code only** option and click **Apply**. Click **Generate code** to generate code for the model.
- 13 Inspect the code generated for your model to see if the replacements occurred as expected. Below, from the generated *model.c* file, are samples of mutex replacements in model step code (`myMutexLock` and `mMutexUnlock`), model initialization code (`myMutexCreate`), and model termination code (`myMutexDelete`), respectively.

```

/* Model step function for TID1 */
void mRateTransition_step1(void)      /* Sample time: [0.01s, 0.0s] */
{
...
  /* RateTransition: '<Root>/F' */
  myMutexLock(mRateTransition_DWork.F_d0_SEMAPHORE);
...
  myMutexUnlock(mRateTransition_DWork.F_d0_SEMAPHORE);
...
  /* End of RateTransition: '<Root>/F' */
...
}

/* Model step function for TID2 */
void mRateTransition_step2(void)      /* Sample time: [0.02s, 0.0s] */
{
  /* RateTransition: '<Root>/F' */
  myMutexLock(mRateTransition_DWork.F_d0_SEMAPHORE);
...
  myMutexUnlock(mRateTransition_DWork.F_d0_SEMAPHORE);
...
  /* End of RateTransition: '<Root>/F' */
...
}

```

```
/* Model initialize function */
void mRateTransition_initialize(void)
{
...
/* Start for RateTransition: '<Root>/F' */
...
myMutexCreate(&mRateTransition_DWork.F_d0_SEMAPHORE);
;
...
}

/* Model terminate function */
void mRateTransition_terminate(void)
{
/* Terminate for RateTransition: '<Root>/F' */
myMutexDelete(mRateTransition_DWork.F_d0_SEMAPHORE);
}
```

Specify Build Information for Code Replacements

- “Functions and Properties for Specifying Table Entry Build Information” on page 23-162
- “Use RTW.copyFileToBuildDir to Copy Files to Build Folder” on page 23-163
- “Include RTW.copyFileToBuildDir In Table Entries” on page 23-164

Note This section describes MATLAB based API functions and properties for specifying build information for code replacements. Alternatively, you can specify build information using the Code Replacement Tool graphical interface. For more information, see “Manage CRTs with the Code Replacement Tool” on page 23-168.

Functions and Properties for Specifying Table Entry Build Information

As you create CRL table entries for function or operator replacement, you specify the header and source file information for each function implementation using one of the following:

- The arguments `ImplementationHeaderFile`, `ImplementationHeaderPath`, `ImplementationSourceFile`, and `ImplementationSourcePath` to `setTf1CFunctionEntryParameters` or `setTf1COperationEntryParameters`
- The `headerFile` argument to `registerCFunctionEntry`, `registerCPPFunctionEntry`, or `registerCPromotableMacroEntry`

Each table entry can specify additional header files, source files, and object files to be included in model builds whenever the CRL table entry is matched and used to replace a function or operator in generated code. To add an additional header file, source file, or object file, use the following CRL table creation functions.

Function	Description
<code>addAdditionalHeaderFile</code>	Add additional header file to array of additional header files for CRL table entry
<code>addAdditionalIncludePath</code>	Add additional include path to array of additional include paths for CRL table entry
<code>addAdditionalLinkObj</code>	Add additional link object to array of additional link objects for CRL table entry
<code>addAdditionalLinkObjPath</code>	Add additional link object path to array of additional link object paths for CRL table entry
<code>addAdditionalSourceFile</code>	Add additional source file to array of additional source files for CRL table entry
<code>addAdditionalSourcePath</code>	Add additional source path to array of additional source paths for CRL table entry

Also, each table entry can specify additional compile flags, additional link flags, or other files to be included in model builds whenever the CRL table

entry is matched and used to replace a function or operator in generated code. To add additional compile or link flags or other files, use the following CRL table entry properties.

Property	Description
AdditionalCompileFlags	Add additional compile flags, specified as cell array of strings, for CRL table entry
AdditionalLinkFlags	Add additional link flags, specified as cell array of strings, for CRL table entry
OtherFiles	Add other files, specified as cell array of strings, for CRL table entry (for example, a DLL file or README file to be copied to the build folder)

For example, the following code provides an additional compile flag for a function entry:

```
fcn_entry = RTW.Tf1CFunctionEntry;
fcn_entry.AdditionalCompileFlags = {'-O3'}
```

Use `RTW.copyFileToBuildDir` to Copy Files to Build Folder

If a CRL table entry uses header, source, or object files that reside in external directories, and if the table entry is matched and used to replace a function or operator in generated code, the external files will need to be copied to the build folder before the generated code is built. The `RTW.copyFileToBuildDir` function can be invoked after code generation to copy the table entry's specified header file, source file, additional header files, additional source files, and additional link objects to the build folder. The copied files are then available for use in the build process.

To direct that a table entry's external files should be copied to the build folder after code generation, specify the argument `'RTW.copyFileToBuildDir'` to the `genCallback` parameter of the CRL function that you use to set the table entry parameters, among the following:

- `registerCFunctionEntry`
- `registerCPPFunctionEntry`

- registerCPromotableMacroEntry
- setTf1CFunctionEntryParameters
- setTf1COperationEntryParameters

Include RTW.copyFileToBuildDir In Table Entries

The following example defines a table entry for an optimized multiplication function that takes signed 32-bit integers and returns a signed 32-bit integer, taking saturation into account. Multiplications in the generated code will be replaced with calls to your optimized function. Your optimized function resides in an external folder and must be copied into the build folder to be compiled and linked into the application.

The multiplication table entry specifies the source and header file names as well as their full paths. To request the copy to be performed, the table entry specifies the argument 'RTW.copyFileToBuildDir' to the genCallback parameter of the setTf1COperationEntryParameters function. In this example, the header file s32_mul.h contains an inlined function that invokes assembly functions contained in s32_mul.s. If the table entry is matched and used to generate code, the RTW.copyFileToBuildDir function will copy the specified source and header files into the build folder.

```
function hTable = make_my_cr1_table

hTable = RTW.Tf1Table;

op_entry = RTW.Tf1COperationEntry;
setTf1COperationEntryParameters(op_entry, ...
    'Key', 'RTW_OP_MUL', ...
    'Priority', 100, ...
    'SaturationMode', 'RTW_SATURATE_ON_OVERFLOW', ...
    'RoundingModes', {'RTW_ROUND_UNSPECIFIED'}, ...
    'ImplementationName', 's32_mul_s32_s32_sat', ...
    'ImplementationHeaderFile', 's32_mul.h', ...
    'ImplementationSourceFile', 's32_mul.s', ...
    'ImplementationHeaderPath', {fullfile('${MATLAB_ROOT}','cr1')}, ...
    'ImplementationSourcePath', {fullfile('${MATLAB_ROOT}','cr1')}, ...
    'GenCallback', 'RTW.copyFileToBuildDir');
```

```
.
.
addEntry(hTable, op_entry);
```

The following example shows the use of the `addAdditional*` functions along with `RTW.copyFileToBuildDir`.

```
hTable = RTW.Tf1Table;

% Path to external source, header, and object files
libdir = fullfile('${MATLAB_ROOT}', '..', '..', 'lib');

op_entry = RTW.Tf1COperationEntry;
setTf1COperationEntryParameters(op_entry, ...
    'Key', 'RTW_OP_ADD', ...
    'Priority', 90, ...
    'SaturationMode', 'RTW_SATURATE_UNSPECIFIED', ...
    'RoundingModes', {'RTW_ROUND_UNSPECIFIED'}, ...
    'ImplementationName', 's32_add_s32_s32', ...
    'ImplementationHeaderFile', 's32_add_s32_s32.h', ...
    'ImplementationSourceFile', 's32_add_s32_s32.c'...
    'GenCallback', 'RTW.copyFileToBuildDir');

addAdditionalHeaderFile(op_entry, 'all_additions.h');
addAdditionalIncludePath(op_entry, fullfile(libdir, 'include'));
addAdditionalSourceFile(op_entry, 'all_additions.c');
addAdditionalSourcePath(op_entry, fullfile(libdir, 'src'));
addAdditionalLinkObj(op_entry, 'addition.o');
addAdditionalLinkObjPath(op_entry, fullfile(libdir, 'bin'));

.
.
.
addEntry(hTable, op_entry);
```

Add Code Replacement Library Reserved Identifiers

The Simulink Coder software reserves certain words for its own use as keywords of the generated code language. Reserved keywords for code generation are for use internal to the Simulink Coder software or C programming and should not be used in Simulink models as identifiers or function names. Reserved keywords for code generation

include many CRL identifiers, the majority of which are function names, such as `acos`. To view a list of reserved identifiers for the CRL that you are using to generate code, call the MATLAB function `RTW.TargetRegistry.getInstance.getTf1ReservedIdentifiers`, passing the name of the CRL as displayed in the **Code replacement library** menu on the **Code Generation > Interface** pane of the Configuration Parameters dialog box. For example,

```
cr1_ids = RTW.TargetRegistry.getInstance.getTf1ReservedIdentifiers('GNU99 (GNU)')
```

For more information, see “Simulink Coder Code Replacement Library Keywords” in the Simulink Coder documentation.

In a CRL table, each function implementation name defined by a table entry is registered as a reserved identifier. You can register additional reserved identifiers for the table on a per-header-file basis. Providing additional reserved identifiers can help prevent duplicate symbols and other identifier-related compile and link issues.

To register additional CRL reserved identifiers, use the following function.

Function	Description
<code>setReservedIdentifiers</code>	Register specified reserved identifiers to be associated with CRL table

You can register up to four reserved identifier structures in a CRL table. One set of reserved identifiers can be associated with an arbitrary CRL, while the other three (if present) must be associated with ANSI, ISO¹², or GNU¹³ libraries. The following example shows a reserved identifier structure that specifies two identifiers and the associated header file.

```
d{1}.LibraryName = 'ANSI';
d{1}.HeaderInfos{1}.HeaderName = 'math.h';
d{1}.HeaderInfos{1}.ReservedIds = {'y0', 'y1'};
```

12. ISO® is a registered trademark of the International Organization for Standardization.

13. GNU® is a registered trademark of the Free Software Foundation.

The specified identifiers are added to the reserved identifiers collection and honored during the build procedure. For more information and examples, see `setReservedIdentifiers`.

Manage CRTs with the Code Replacement Tool

In this section...

“Code Replacement Tool” on page 23-168

“Create Code Replacement Table for a Sample Model” on page 23-169

“Create Code Replacement Table for a Sample MATLAB Coder Project” on page 23-176

“Create and Modify Code Replacement Tables” on page 23-183

“Validate Code Replacement Tables and Table Entries” on page 23-189

“Generate a Code Replacement Registration File” on page 23-189

Code Replacement Tool

The Code Replacement Tool provides a graphical interface for creating and managing the code replacement tables (CRTs) that make up a code replacement library (CRL). You can:

- Create a new code replacement table or import existing tables.
- Add, modify, and delete table entries. Each table entry represents a potential code replacement for a single function or operator. You can manage multiple tables together and copy and paste entries between tables.
- Validate tables and table entries.
- Save code replacement tables as MATLAB files.
- Generate the customization file to register your code replacement tables with code generation software.

Each code replacement table contains one or more table entries. Each table entry represents a potential replacement of a single function or operator by a custom implementation during code generation. For each table entry, you provide:

- **Mapping Information**, which relates a conceptual view of the function or operator — similar to the Simulink block view of the function or operator — to a custom implementation of that function or operator.

- **Build Information**, which provides header, source, or link information required for building the custom implementation.

For detailed information about the Code Replacement Tool workflow, see “Create and Modify Code Replacement Tables” on page 23-183, “Validate Code Replacement Tables and Table Entries” on page 23-189, and “Generate a Code Replacement Registration File” on page 23-189. For introductory examples, see “Create Code Replacement Table for a Sample Model” on page 23-169 and “Create Code Replacement Table for a Sample MATLAB Coder Project” on page 23-176.

Create Code Replacement Table for a Sample Model

Here is a simple example of the complete Code Replacement Tool workflow.

- 1** Start a new MATLAB session. Navigate (`cd`) to a folder that does not have artifacts from previous code replacement library (CRL) work, such as CRL table definition files or CRL registration files.
- 2** Open the Code Replacement Tool by entering the MATLAB command `crtool`.
- 3** Create a new code replacement table using **File > New table**. This table will define one or more entries for replacing generated code for the math function `sin` with a custom C implementation. In the right-most pane, in the **Name** field, enter a name for the code replacement table, `cr1_table_sinfcn`, and click **Apply**. Later, when you save this table to a MATLAB file, the tool will save it with the name `cr1_table_sinfcn.m`.

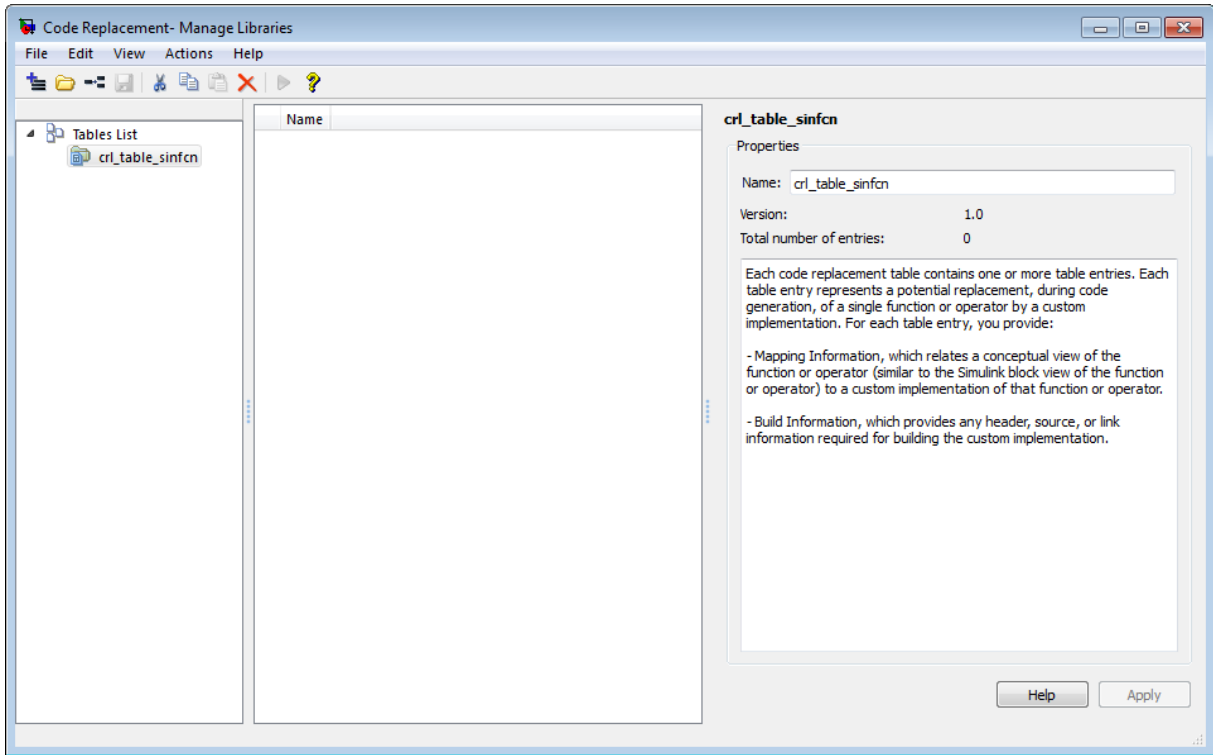

- 4 Create a table entry using **File > New entry > Function**. The new table entry appears in the middle pane, initially without a name.
- 5 This table entry will map a `sin` function with double input and double output to a custom implementation function named `sin_dbl`, defined in header file `sin_dbl.h`. Select the table entry in the middle pane, go to the **Mapping Information** tab in the right pane, and configure the mapping information as follows:
 - a In the **Function** parameter drop-down list, select `sin`. Leave the **Algorithm** parameter set to `Unspecified`, and leave the parameters in the **Conceptual function** group at their default values.
 - b In the **Replacement function** group, for the **Name** parameter, enter `sin_dbl`. Click **Apply**. The **Function signature preview** automatically updates to reflect the specified replacement function

name. Leave the remaining parameters in the **Replacement function** group at their default values.

- To validate the table entry so far, go to the bottom of the tab and click **Validate entry**. The completed mapping information is shown in the following figure.

Mapping Information

Build Information

Function: sin

Entry information

Algorithm: Unspecified

Conceptual function

Used by code generation process for matching purposes

Conceptual arguments

y1
u1

Argument properties

Data type: double

Complex

Argument type: Scalar

Make conceptual and implementation argument types the same

Replacement function

Function prototype

Name: sin_dbl C++ namespace:

Function returns void

Function arguments

y1(return arg)
u1

Argument properties

Data type: double I/O type: OUTPUT

Const Pointer Complex

X
+

Function signature preview

```
double sin_dbl( double u1 );
```

Implementation attributes

Integer saturation mode: Unspecified Saturation

Rounding mode: Unspecified Rounding

Allow expressions as inputs

Function modifies internal or global state

[Click here to add Build Information](#)

Validation

Validate entry Status: Validated

Help
Apply

- Go to the **Build Information** tab in the right pane, and configure the build information as follows. In the **Implementation Header File** parameter field, enter the header file specification `sin_dbl.h`. Click **Apply**. For this example, you can leave the other **Build Information** parameters at their default values.

The screenshot shows the 'Build Information' tab in the Code Replacement Tool. The 'Implementation Header File' field is set to 'sin_dbl.h'. Below it are three lists for 'Additional Header Files/Include Paths', 'Additional Source Files/Paths', and 'Additional Link Object Files/Paths', each with 'File...' and 'Path...' buttons. At the bottom, there are fields for 'Additional Link Flags' and 'Additional Compile Flags', and a checkbox for 'Copy files to Build Directory'.

Optionally, you can revalidate the modified table entry, by returning to **Mapping Information** and clicking the **Validate entry** button.

- Optionally, you can create a second table entry that maps a `sin` function with `single` input and `double` output to a custom implementation function named `sin_sgl`. Copy and paste the first entry to create a second entry.

Then, in the second entry, modify the input specifications (conceptual and replacement) from `double` to `single`. Modify the replacement function name and header file from `sin_dbl` to `sin_sgl`.

	Name	Implementation	NumIn	In1Type	In2Type	OutType	Priority
✓	sin	sin_dbl	1	double		double	100
✓	sin	sin_sgl	1	single		double	100

- 8 Validate the code replacement table, for example, using **Actions > Validate table**. If errors are reported, fix the errors, and retry the validation. Repeat until errors are not reported.
- 9 Save the table to a MATLAB file in your working folder, for example, using **File > Save table**. The name of the saved file is the table name, `cr1_table_sinfcn`, with an `.m` extension. Optionally, you can open the saved file in a text editor and examine the MATLAB code for the CRL table definition.
- 10 Create a CRL registration file, `rtwTargetInfo.m`, that includes your code replacement table. Select **File > Generate registration file** to open the Generate registration file dialog box. Edit the dialog box fields to match the following figure.

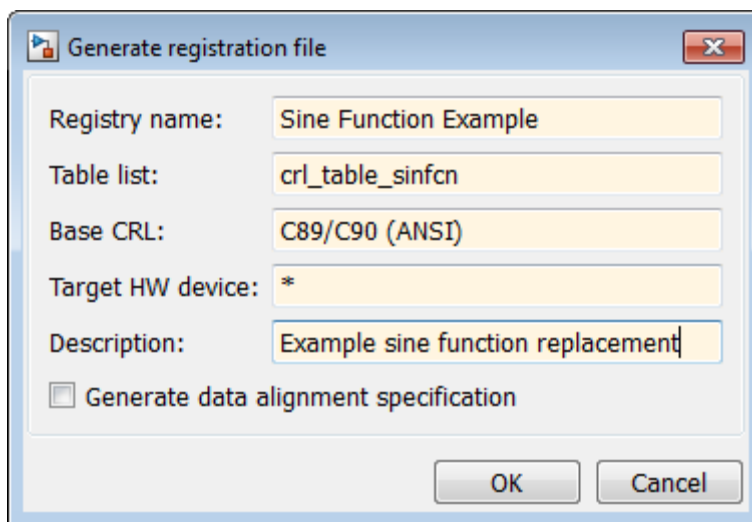

Click **OK**. The Select location dialog box opens. Use the dialog box to specify a location for the registration file. The location must be on the MATLAB path or in the current working folder. Save the file.

Optionally, you can open the generated file in a text editor and examine the MATLAB code for the CRL registry entry.

- 11** To register your CRL with code generation software without having to restart MATLAB, enter the following MATLAB command:

```
>> RTW.TargetRegistry.getInstance('reset');
```

- 12** Open an ERT-based Simulink model. Go to the **Code Generation > Interface** pane of the Configuration Parameters dialog box. Verify that the **Code replacement library** option lists the CRL name that you specified and select it.

Note If you hover over the selected library with the cursor, a tool tip appears. This tip contains information derived from your CRL registration file, such as the CRL description and the list of tables it contains.

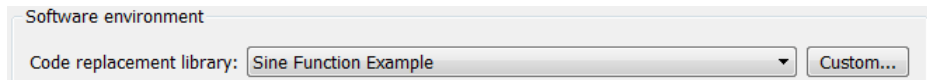

- 13** Create an ERT-based model with a Trigonometric Function block set to the sine function, for example:

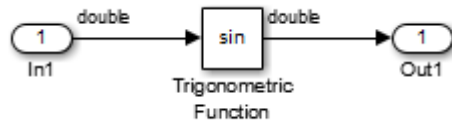

Check that the CRL you registered, Sine Function Example, is selected for this model.

- 14** Go to the **Code Generation > Report** pane of the Configuration Parameters dialog box. Select the options **Create code generation**

report and **Model-to-code**. Then go to the **Code Generation** pane, select the **Generate code only** option, and generate code for the model.

- 15 Go to Simulink Editor and use model-to-code highlighting to trace the code generated using your CRL entry. For example, right-click the Trigonometric Function block and select **C/C++ Code > Navigate to C/C++ Code**. This selection highlights the `sin` function code within the model step function in `sine_double.c`. In this case, `sin` has been replaced with `sin_dbl` in the generated code.

```

25
26  /* Real-time model */
27  RT_MODEL_sine_double sine_double_M;
28  RT_MODEL_sine_double *const sine_double_M = &sine_double_M;
29
30  /* Model step function */
31  void sine_double_step(void)
32  {
33      /* Outport: '<Root>/Out1' incorporates:
34       * Inport: '<Root>/In1'
35       * Trigonometry: '<Root>/Trigonometric Function'
36       */
37      sine_double_Y.Out1 = sin_dbl(sine_double_U.In1);
38  }
39
40  /* Model initialize function */
41  void sine_double_initialize(void)
42  {

```

Create Code Replacement Table for a Sample MATLAB Coder Project

This example shows how to use the Code Replacement Tool when generating C code from MATLAB code in a MATLAB Coder project.

- 1 Start a new MATLAB session. Navigate (`cd`) to a folder that does not have artifacts from previous code replacement library (CRL) work, such as CRL table definition files or CRL registration files.
- 2 Create a new MATLAB Coder project.

```
coder -new code_replace.prj
```

By default, the project opens in the MATLAB workspace on the right side.

- 3 In the same folder, create a MATLAB file, `foo.m`.

```
function y = foo(u)
    y=sin(u);
end
```

- 4 On the project **Overview** tab, click the **Add files** link. Browse to the file `foo.m` and then click **OK** to add the file to the project.
- 5 In the project, define the type of input `u`.
 - a On the **Overview** tab, click the field to the right of the input parameter `u` and then, from the list of input options, select **double**.
 - b From the list of size options, select `1 x 1` to specify that `u` is a scalar.
- 6 In the project, select the **Build** tab.
- 7 On the **Build** tab, set **Output type** to `C/C++ Static Library`.
- 8 Click the **More settings** link.
- 9 In the **Project Settings** dialog box, select the **Hardware** tab.
- 10 On the **Hardware** tab, click the **Custom** link to open the Code Replacement Tool.
- 11 In the Code Replacement Tool, create a new code replacement table using **File > New table**. This table defines one or more entries for replacing generated code for the math function `sin` with a custom C implementation. In the right-most pane, in the **Name** field, enter a name for the code replacement table, `cr1_table_sinfcn`, and click **Apply**. Later, when you save this table to a MATLAB file, the tool saves it with the name `cr1_table_sinfcn.m`.

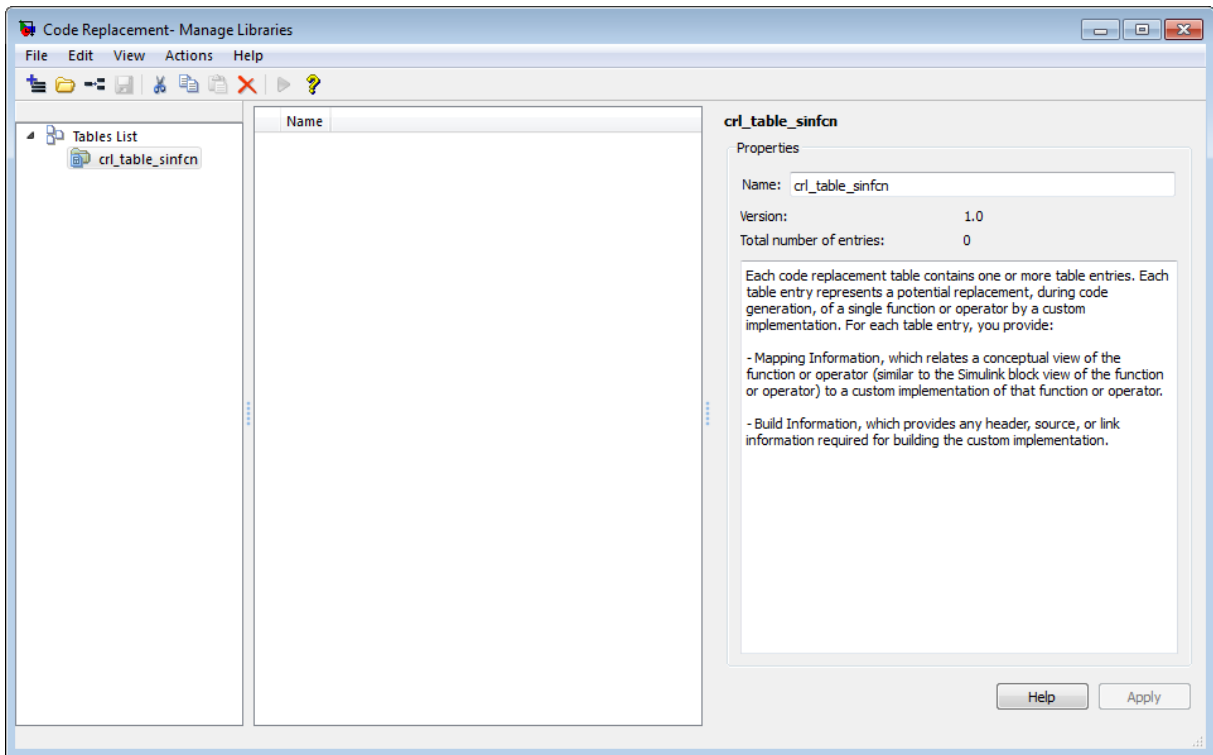

- 12 Create a table entry using **File > New entry > Function**. The new table entry is displayed in the middle pane, initially without a name.
- 13 This table entry maps a `sin` function with double input and double output to a custom implementation function named `sin_db1`, defined in header file `sin_db1.h`. Select the table entry in the middle pane, go to the **Mapping Information** tab in the right pane, and configure the mapping information:
 - a Set **Function** to `sin`. Leave the **Algorithm** parameter set to **Unspecified**. Leave the parameters in the **Conceptual function** group at their default values.
 - b In the **Replacement function** group, for the **Name** parameter, enter `sin_db1`. Click **Apply**.

The **Function signature preview** automatically updates to reflect the specified replacement function name. Leave the remaining parameters in the **Replacement function** group at their default values.

- To validate the table entry so far, go to the bottom of the tab and click **Validate entry**. The completed mapping information is displayed.

Mapping Information

Build Information

Function: sin

Entry information

Algorithm: Unspecified

Conceptual function

Used by code generation process for matching purposes

Conceptual arguments

y1
u1

Argument properties

Data type: double

Complex

Argument type: Scalar

Make conceptual and implementation argument types the same

Replacement function

Function prototype

Name: sin_dbl C++ namespace:

Function returns void

Function arguments

y1(return arg) ↑

u1 ↓

Argument properties

Data type: double I/O type: OUTPUT

Const Pointer Complex

✕ +

Function signature preview

`double sin_dbl(double u1);`

Implementation attributes

Integer saturation mode: Unspecified Saturation

Rounding mode: Unspecified Rounding

Allow expressions as inputs

Function modifies internal or global state

[Click here to add Build Information](#)

Validation

Validate entry Status: Validated

Help

Apply

- 14** Go to the **Build Information** tab in the right pane, and configure the build information. In the **Implementation Header File** parameter field, enter the header file specification `sin_dbl.h`. Click **Apply**. For this example, you can leave the other **Build Information** parameters at their default values.

The screenshot shows the 'Build Information' tab of a configuration window. It contains the following fields and controls:

- Implementation Header File:** A text field containing 'sin_dbl.h' and a browse button (...).
- Implementation Source File:** An empty text field and a browse button (...).
- Additional Header Files/ Include Paths:** A large empty text area, a 'File...' button, a 'Path...' button, and a close button (X).
- Additional Source Files/ Paths:** A large empty text area, a 'File...' button, a 'Path...' button, and a close button (X).
- Additional Link Object Files/ Paths:** A large empty text area, a 'File...' button, a 'Path...' button, and a close button (X).
- Additional Link Flags:** An empty text field.
- Additional Compile Flags:** An empty text field.
- Copy files to Build Directory:** A checkbox that is currently unchecked.

Optionally, you can revalidate the modified table entry by returning to **Mapping Information** and clicking **Validate entry**.

- 15** Optionally, you can create a second table entry that maps a `sin` function with `single` input and `double` output to a custom implementation function named `sin_sgl`. Copy and paste the first entry to create a second entry. Then, in the second entry, modify the input specifications (conceptual and

replacement) from `double` to `single`. Modify the replacement function name and header file from `sin_dbl` to `sin_sgl`.

	Name	Implementation	NumIn	In1Type	In2Type	OutType	Priority
✓	sin	sin_dbl	1	double		double	100
✓	sin	sin_sgl	1	single		double	100

- 16 Validate the code replacement table using **Actions > Validate table**. If errors are reported, fix the errors, and retry the validation. Repeat until errors are not reported.
- 17 Select **File > Save table** to save the table to a MATLAB file in your working folder. The name of the saved file is the table name, `crl_table_sincfn`, with a `.m` extension. Optionally, you can open the saved file in a text editor and examine the MATLAB code for the CRL table definition.
- 18 Create a CRL registration file, `rtwTargetInfo.m`, that includes your code replacement table. Select **File > Generate registration file**.
- 19 In the Generate registration file dialog box, edit the dialog box fields to match the following figure.

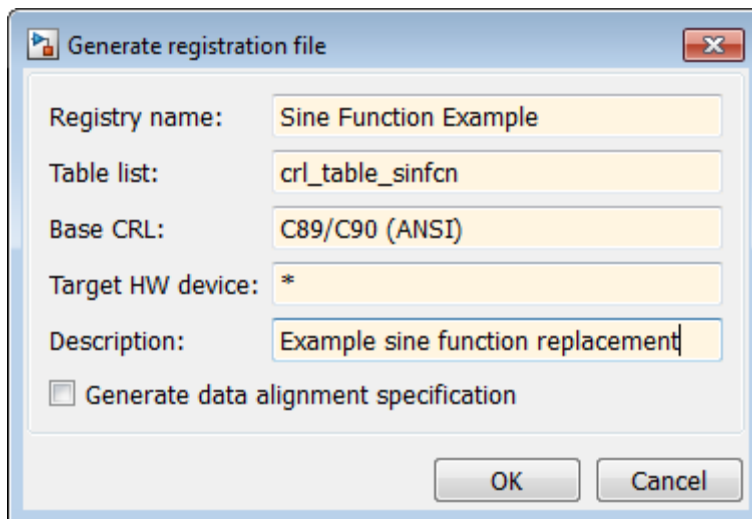

Click **OK**. The Select location dialog box opens. Use the dialog box to specify a location for the registration file. The location must be on the MATLAB path or in the current working folder. Save the file.

Optionally, you can open the generated file in a text editor and examine the MATLAB code for the CRL registry entry.

- 20** To register your CRL with code generation software without having to restart MATLAB, enter the following MATLAB command:

```
>> RTW.TargetRegistry.getInstance('reset');
```

- 21** In the **Project Settings** dialog box, on the **Hardware** tab, set **Code replacement library** to Sine Function Example.

- 22** On the **Build** tab, click **Build**.

MATLAB Coder builds the project and generates a C static library and supporting files in the default folder, `codegen/lib/foo`. It also provides a link to the code generation report.

- 23** Click the **View report** link.

- 24** In the code generation report, view the C code generated for the `foo` function.

The call to `sin` has been replaced with `sin_dbl` in the generated code.

```
real_T foo(real_T u)
{
    return sin_dbl(u);
}
```

Create and Modify Code Replacement Tables

- “Open the Code Replacement Tool” on page 23-184
- “Open and Save Code Replacement Tables” on page 23-185
- “Configure Code Replacement Tables” on page 23-187

Open the Code Replacement Tool

You can open the Code Replacement Tool in the following ways:

- From the Simulink Editor, open the Configuration Parameters dialog box. Go to the **Code Generation > Interface** pane, and click the **Custom** button located to the right of the **Code replacement library** parameter.

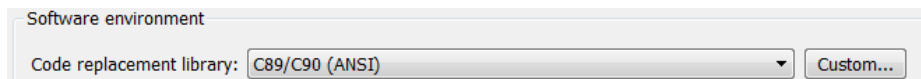

Note The **Custom** button appears only for ERT-based targets. Creating custom code replacement tables requires an Embedded Coder license.

- In the MATLAB Command Window, enter the command `crtool`.

When first used, here is how the Code Replacement Tool dialog box looks:

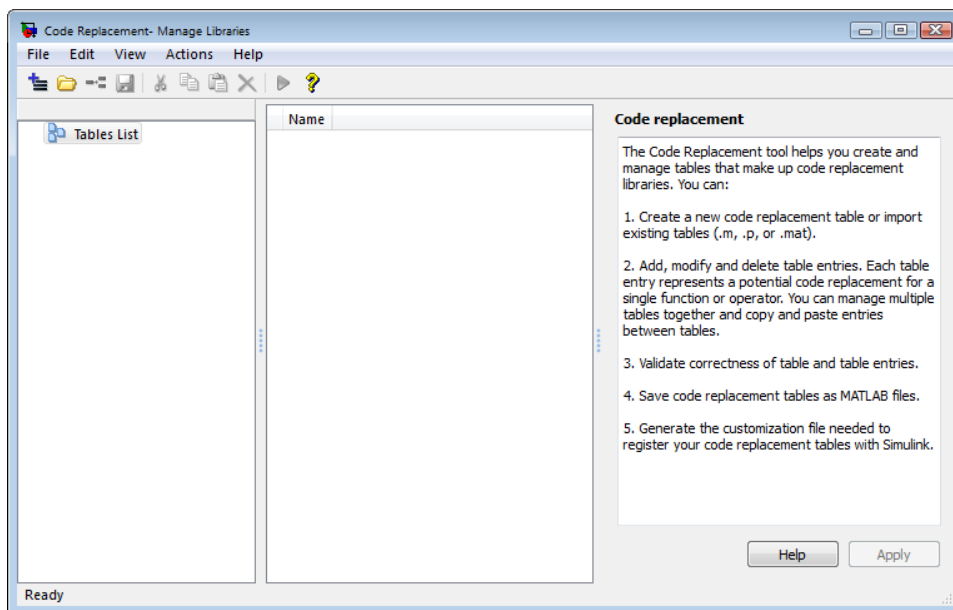

You can access table operations in the following ways:

- Available actions are provided through menus, including **File**, **Edit**, **View**, **Actions**, and **Help**. You can also right-click in most areas to open context menus. Additionally, many menu items list equivalent keyboard shortcuts.
- Common actions are available through icons. You can hover over each icon to see a description.
- Keyboard shortcuts are provided for most operations.
- Cut, copy, paste, and delete operations are provided by **Edit** menu entries and by icons. You can copy and paste many types of information. The **Edit** menu additionally provides specialized **Copy Build information** and **Paste Build information** operations.

Open and Save Code Replacement Tables

To open an existing code replacement table, select **File > Open table** to launch the Import file dialog box. Browse to the MATLAB file that contains the table. Optionally, you can repeat the sequence to open additional tables, and potentially work on multiple tables together. Here is a sample display with two tables opened.

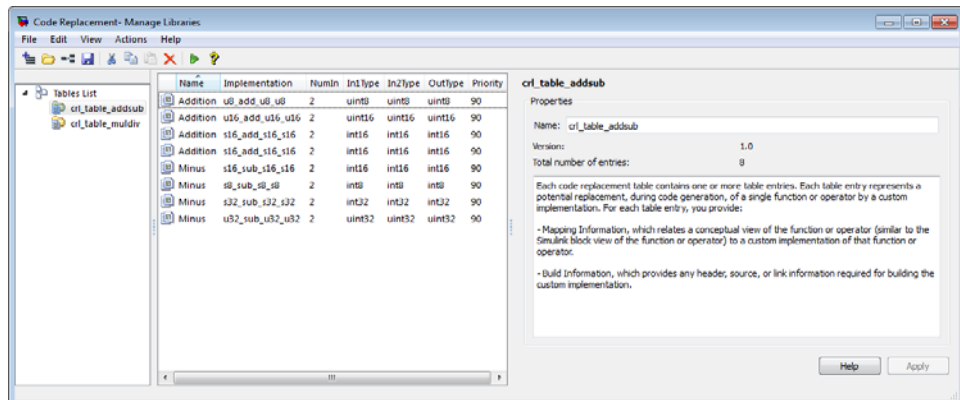

By default, the tool displays, left to right, a root pane, a list pane, and a dialog pane. You can manipulate the display using the following controls:

- Drag boundaries to widen, narrow, shorten, or lengthen panes, and to resize table columns.
- Select **View > Show dialog pane** to hide or display the right-most pane. (The **View** menu also contains the option **Prompt if dialog has unapplied changes**, which is selected by default.)
- Click a table column heading to sort the table according to the contents of the selected column.
- Right-click a table column heading and select **Hide** to remove the column from the display. (You cannot hide the **Name** column.)

If you open multiple tables, you can manage the tables together. Use the available menu entries and icons to create new table entries, delete table entries, and copy and paste or cut and paste information between tables.

To create a new code replacement table and add it to the Tables List in the left-most pane, select **File > New table**. The new table initially is empty.

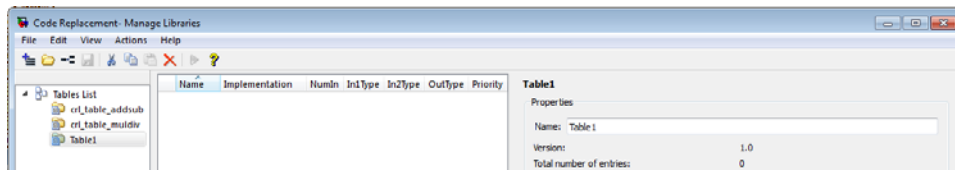

Next, you add one or more table entries, each representing a potential function or operator replacement. The Code Replacement Tool provides several types of table entries for replacing math operators and functions. It also provides a specialized type known as a custom CRL table entry, described in “Refine Matching and Replacement Using Custom Entries” on page 23-133. After you add each table entry, you configure its displayed attributes. Each entry relates a conceptual view of the function or operator to be replaced — similar to the Simulink block view of the function or operator — to a custom implementation of that function or operator. For more information, see “Configure Code Replacement Tables” on page 23-187.

To save each table to a MATLAB file, select **File > Save table**. The Browse For Folder dialog box opens. Use the dialog box to specify a location for the file. Typically, you select a location on the MATLAB path. Save the file. The name for the saved file is the table name specified in the **Name** field in the

middle pane of the Code Replacement Tool, with the extension `.m`. You cannot rename a table during the save operation.

Configure Code Replacement Tables

- “About Code Replacement Configuration” on page 23-187
- “Mapping Information” on page 23-188
- “Build Information” on page 23-189

About Code Replacement Configuration. To configure a code replacement table, you open or create the table as described in “Open and Save Code Replacement Tables” on page 23-185. Then, you add, modify, and delete table entries. Each table entry represents a potential code replacement for a single function or operator by a custom implementation during code generation. You can configure multiple tables together and copy and paste entries between tables. Before saving a configured table, you validate it, as described in “Validate Code Replacement Tables and Table Entries” on page 23-189. You can also use the Code Replacement Tool to generate the registration file to register your tables with the code generation software, as described in “Generate a Code Replacement Registration File” on page 23-189.

To configure a table entry, select the table in the left pane, select the table entry in the middle pane, then examine and modify its attributes in the right-most pane. For most types of table entries, the attributes are grouped in two tabs within the right-most pane, **Mapping Information** and **Build Information**.

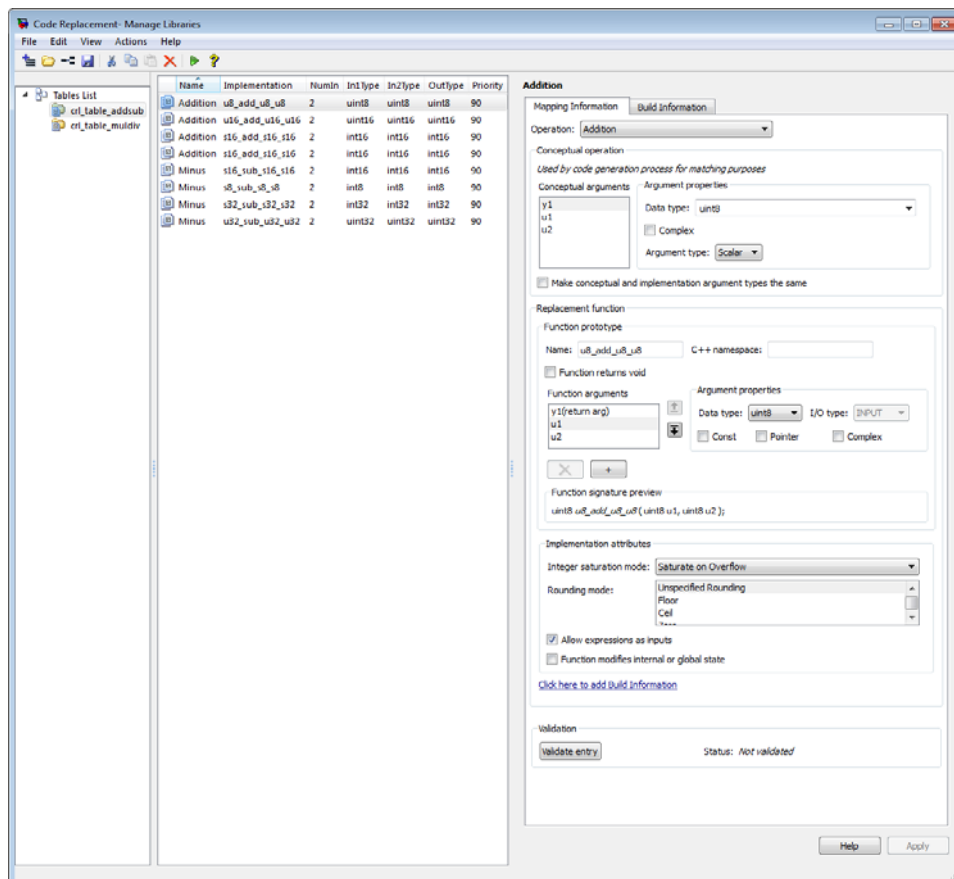

For a basic example of creating a new code replacement table, configuring it, validating it, registering it, and using it for code generation, see “Create Code Replacement Table for a Sample Model” on page 23-169.

Mapping Information. The **Mapping Information** tab for a code replacement table entry relates a conceptual view of the function or operator — similar to the Simulink block view of the function or operator — to a custom implementation of that function or operator.

Build Information. The **Build Information** tab for a code replacement table entry provides header, source, or link information required for building the custom implementation.

Validate Code Replacement Tables and Table Entries

The Code Replacement Tool allows you to validate the syntactic correctness of code replacement tables and table entries as you configure them. If validation finds errors, you can address the errors and retry the validation. Repeat until errors are not reported. You can run validation in the following ways:

- To validate a table entry, select the entry, go to the bottom of the **Mapping Information** tab, and click **Validate entry**. Alternatively, you can select multiple entries and use right-click to select validation for all of them.
- To validate a table, select the table, and select **Actions > Validate table**.
- When you save a table, validation is run on any unvalidated content in the table.

Generate a Code Replacement Registration File

To register a code replacement library containing your code replacement tables with the code generation software, you must create a registration file, as described in “Register Code Replacement Libraries” on page 23-203. The Code Replacement tool provides a graphical interface for creating the registration file. After you have validated and saved your code replacement tables, select **File > Generate registration file** to open the Generate registration file dialog box.

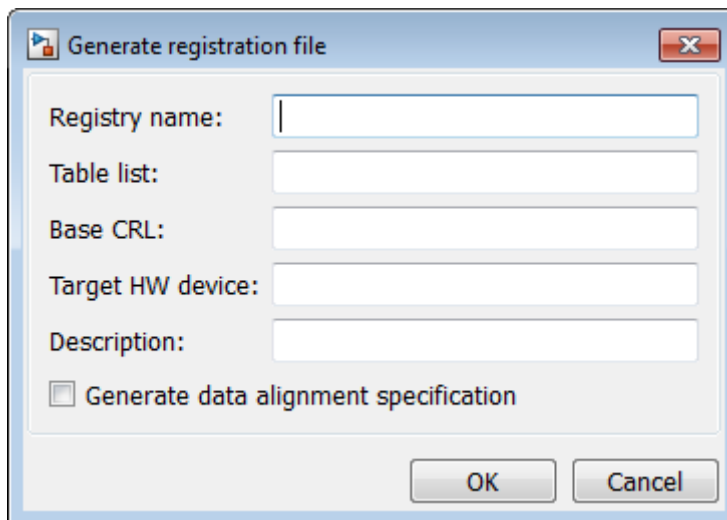

The dialog box fields correspond to the CRL registry entry properties described in “Register Code Replacement Libraries” on page 23-203. For an example of registering a custom CRL using the Code Replacement Tool, see “Create Code Replacement Table for a Sample Model” on page 23-169.

Examine and Validate Code Replacement Tables

In this section...

“Overview of Code Replacement Table Validation” on page 23-191

“Invoke the Table Definition File” on page 23-191

“Use Code Replacement Viewer to Examine Tables” on page 23-192

“Use Code Replacement Viewer to Examine CRLs” on page 23-193

“Trace Code Replacements Generated Using Your CRL” on page 23-195

“Determine Why Code Replacement Functions Not Used” on page 23-198

Overview of Code Replacement Table Validation

After you create a code replacement library (CRL) table containing your code replacement entries, but before you deploy production CRLs containing your table for general use in building models, you can use various techniques to examine and validate the CRL table entries. These include:

- Invoking the table definition file
- Using the Code Replacement Viewer at various stages of CRL development to examine CRLs, tables, and entries
- Tracing code generated from models for which your CRL is selected
- Examining CRL cache hits and misses logged during code generation

Invoke the Table Definition File

Immediately after creating or modifying a table definition file (as described in “Create Code Replacement Tables” on page 23-18), you should invoke it at the MATLAB command line. This invocation serves as a check of the validity of your table entries. For example,

```
>> tbl = crl_table_sinfcn
```

```
tbl =
```

```
RTW.Tf1Table
```

```
Version: '1.0'
```

```
        AllEntries: [2x1 RTW.Tf1CFunctionEntry]
        ReservedSymbols: []
        StringResolutionMap: []
>>
```

Errors found during the invocation are displayed. In the following example, a typo in a data type name is detected and displayed.

```
>> tbl = cr1_table_sinfcn
??? RTW_CORE:tf1:Tf1Table: Unsupported data type, 'dooble'.

Error in ==> cr1_table_sinfcn at 7
hTable.registerCFunctionEntry(100, 1, 'sin', 'dooble', 'sin_dbl', ...

>>
```

Use Code Replacement Viewer to Examine Tables

After creating or modifying a table definition file, as a further check of your table entries, you should use the Code Replacement Viewer to display and examine your table. Invoke the Code Replacement Viewer using the following form of the MATLAB command `RTW.viewTf1`:

```
RTW.viewTf1(table-name)
```

For example,

```
>> RTW.viewTf1(cr1_table_sinfcn)
```

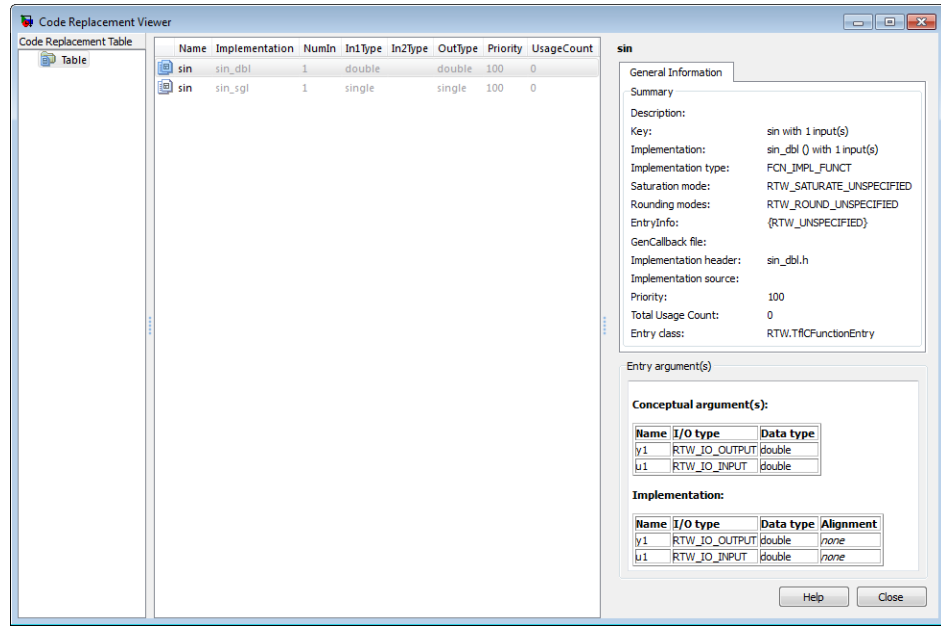

Select entries in your table and verify that the graphical display of the contents of your table meets your expectations. Common problems that can be detected at this stage include:

- Incorrect argument order
- Conceptual argument naming that does not match the naming convention used by the code generation process
- Incorrect relative priority of entries within the table (highest priority is 0, and lowest priority is 100).

For more information about the Code Replacement Viewer, see “Using the Code Replacement Viewer” in the Simulink Coder documentation.

Use Code Replacement Viewer to Examine CRLs

After you register a CRL that includes your code replacement table (as described in “Register Code Replacement Libraries” on page 23-203), you should use the Code Replacement Viewer to verify that your CRL was

properly registered and to examine the CRL and the tables it contains. Invoke the Code Replacement Viewer using the MATLAB command `RTW.viewTf1` without arguments. This command displays the CRLs registered in the current Simulink session. For example:

```
>> RTW.viewTf1
```

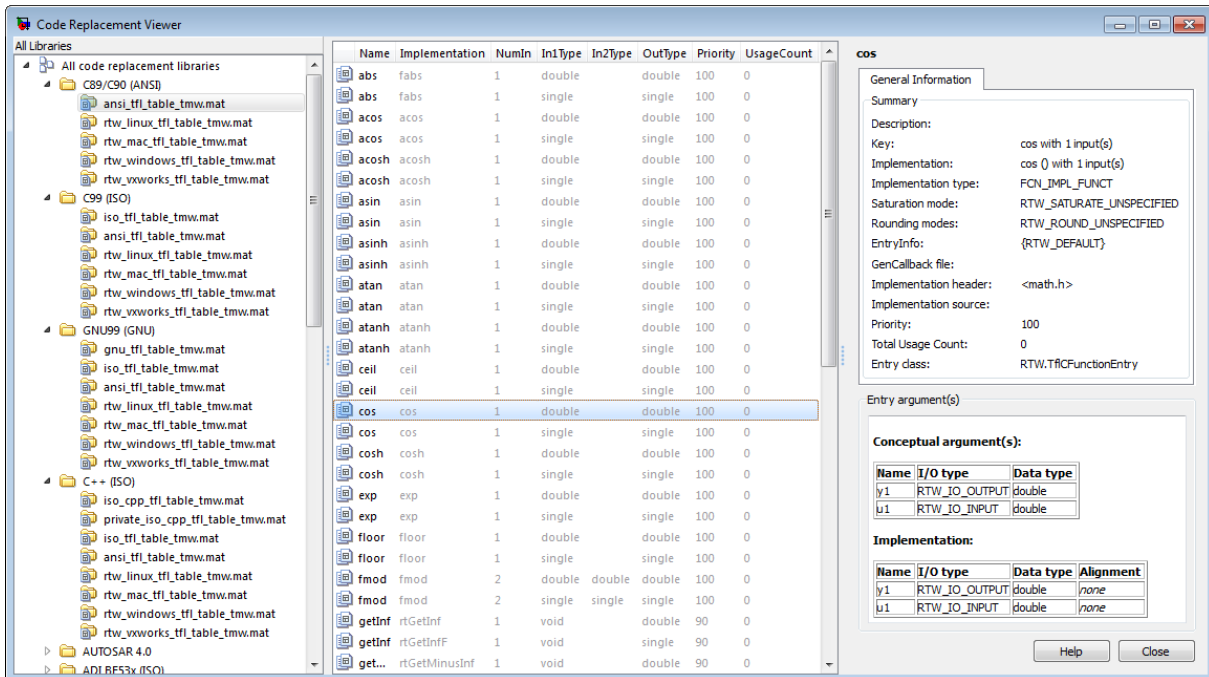

If your CRL is not displayed,

- There may be an error in your CRL registration file.
- You may need to refresh the CRL registration information, by issuing the refresh command for your registration mechanism: `sl_refresh_customizations` for `sl_customization.m`, or `RTW.TargetRegistry.getInstance('reset')` for `rtwTargetInfo.m`.

If your CRL is displayed, select the CRL and examine and compare its tables, including their relative order. Common problems that can be detected at this stage include

- Incorrect relative order of tables in the library (tables are displayed in search order)
- Table entry problems as listed in the previous section

For more information about the Code Replacement Viewer, see “Using the Code Replacement Viewer” in the Simulink Coder documentation.

Trace Code Replacements Generated Using Your CRL

After you register a CRL that includes your code replacement tables, you should use the CRL to generate code and verify that you are obtaining the function or operator replacement that you expect. The following example illustrates two complementary approaches:

- Check the Code Replacement Report section of the HTML code generation report for a specific expected replacement
- Using model-to-code highlighting to trace a specific expected replacement

- 1** Open an ERT-based model for which you anticipate that a function or operator replacement should occur. This example uses the example model `.rtwdemo_crladdsub`.
- 2** Select your CRL in the **Code replacement library** drop-down list on the **Code Generation > Interface** pane of the Configuration Parameters dialog box.
- 3** Go to the **Code Generation > Report** pane of the Configuration Parameters dialog box and select the options **Create code generation report**, **Open report automatically**, **Model-to-code**, and **Summarize which blocks triggered code replacements**.
- 4** Go to the **Code Generation** pane, select the **Generate code only** option, and generate code for the model.
- 5** Go to the **Code Replacements Report** section of the HTML code generation report. This report section lists the replacement functions that were used during code generation, and provides a mapping between each replacement instance and the Simulink block that triggered the replacement. Inspect the report to see if the function or operator replacement occurred as you expected. If the replacement function is listed,

you can click on each instance of its use to highlight the Simulink block that triggered the replacement. Also, the report provides a link that opens up the code replacement library for the model in the Code Replacement Viewer, so that you can review code replacement hits and misses.

Code replacements in `rtwdemo_crladdsub`

Code replacements for library 'Addition & Subtraction Examples'. The library comprises:

- Addition & Subtraction Examples
 - `crl_table_addsub`
- C89/C90 (ANSI)

To see the replacements and misses in the Code Replacement Viewer, look [here](#).

1. Addition operator replacements in `rtwdemo_crladdsub` [\[hide\]](#)

The following table provides a mapping from the addition operators used from the selected Code Replacement Library to the blocks in the model that triggered the replacement.

Function	Block
<code>s16_add_s16_s16</code>	rtwdemo_crladdsub/ChartAdd16:1
<code>u8_add_u8_u8</code>	rtwdemo_crladdsub/Add8
<code>u16_add_u16_u16</code>	rtwdemo_crladdsub/Add16

2. Subtraction operator replacements in `rtwdemo_crladdsub` [\[hide\]](#)

The following table provides a mapping from the subtraction operators used from the selected Code Replacement Library to the blocks in the model that triggered the replacement.

Function	Block
<code>u32_sub_u32_u32</code>	rtwdemo_crladdsub/EmbSub32
<code>s8_sub_s8_s8</code>	rtwdemo_crladdsub/Sub8
<code>s32_sub_s32_s32</code>	rtwdemo_crladdsub/Sub32

- 6 Go to Simulink Editor and use model-to-code highlighting to trace the code generated using your CRL. For example, right-click a block that you expect to have generated a function or operator replacement and select **C/C++**

Code > Navigate to C/C++ Code. This selection highlights the applicable generated function code within the HTML code generation report display of `rtwdemo_crladdsub.c`.

```
25
26  /* Real-time model */
27  RT_MODEL rtM;
28  RT_MODEL *const rtM = &rtM_;
29
30  /* Model step function */
31  void rtwdemo_crladdsub_step(void)
32  {
33      /* Outport: '<Root>/Out1' incorporates:
34       * Inport: '<Root>/In1'
35       * Inport: '<Root>/In2'
36       * Sum: '<Root>/Add8'
37       */
38      rtY.Out1 = u8_add_u8_u8(rtU.In1, rtU.In2);
39
40      /* Outport: '<Root>/Out2' incorporates:
41       * Inport: '<Root>/In3'
42       * Inport: '<Root>/In4'
43       * Sum: '<Root>/Add16'
44       */
45      rtY.Out2 = u16_add_u16_u16(rtU.In3, rtU.In4);
46
```

Inspect the generated code and see if the function or operator replacement occurred as you expected.

Note If a function or operator was not replaced as you expected, it means that a call site request was not matched as you intended by your table entry attributes. Either a higher-priority (lower priority value) match was used or a match was not found. You can analyze the CRL table entry matching behavior by using the following resources together:

- Code Replacement Viewer, as described in “Use Code Replacement Viewer to Examine Tables” on page 23-192 and “Use Code Replacement Viewer to Examine CRLs” on page 23-193
 - HTML code generation reports, with bidirectional tracing including model-to-code highlighting, and the ability to map replacement functions to associated blocks
 - Information about CRL cache hits and misses logged during code generation, as described in “Determine Why Code Replacement Functions Not Used” on page 23-198
-

Determine Why Code Replacement Functions Not Used

- “About Code Replacement Hits and Misses” on page 23-198
- “Debugging CRL Entries Using Viewer Trace Information” on page 23-199
- “View Cache Hits and Misses Using Command-Line” on page 23-200

About Code Replacement Hits and Misses

Code replacement library (CRL) replacement may behave differently than you expect in some cases. To verify that you are obtaining the function or operator replacement that you expect, you first inspect the generated code, as described in “Trace Code Replacements Generated Using Your CRL” on page 23-195.

To analyze replacement behavior, in addition to referencing the HTML code generation report and examining your CRL tables in the Code Replacement Viewer, you can view the CRL cache hits and misses logged during the most recent code generation session. This approach provides information on what data types and attributes should be registered in order to achieve the desired

replacement. The following techniques can help you determine why code replacement functions were not used:

- “Debugging CRL Entries Using Viewer Trace Information” on page 23-199
- “View Cache Hits and Misses Using Command-Line” on page 23-200

Debugging CRL Entries Using Viewer Trace Information

When debugging a CRL table entry, you can use hits and misses information in the Code Replacement Viewer to help determine why a replacement function was not used in the generated code.

Note To generate code replacement trace information for viewing in the Code Replacement Viewer, you must select the **Code Generation > Report** option **Summarize which blocks triggered code replacements** before generating code.

To display the CRL cache hits and misses logged for a CRL table entry during the most recent code generation session:

- 1** Open the Code Replacement Viewer using the following commands:

```
>> crl=get_param('model', 'TargetFcnLibHandle')
>> RTW.viewTf1(crl)
```

- 2** In the left pane, select the CRL table to examine. In the middle pane, the viewer lists every entry in the table, with general information for each, including a usage count, which is the number of times the table entry was matched and its replacement function was used during code generation.
- 3** In the middle pane, select the table entry to examine. In the right pane, the viewer displays **General Information** and **Trace Information** about the table entry.
- 4** In the right pane, select the **Trace Information** tab.

The figure below shows the **Trace Information** display for the example model `rtwdemo_crladdsub`, with the `crl_table_addsub` table selected in the left pane, and the `int16` addition table entry selected in the middle pane.

Name	Implementation	NumIn	In1Type	In2Type	OutType	Priority	UsageCount
RTW_OP_ADD	u8_add_u8_u8	2	uint8	uint8	uint8	90	1
RTW_OP_ADD	u16_add_u16_u16	2	uint16	uint16	uint16	90	1
RTW_OP_ADD	s16_add_s16_s16	2	int16	int16	int16	90	2
RTW_OP_ADD	s16_add_s16_s16	2	int16	int16	int16	90	0
RTW_OP_ADD	s16_add_s16_s16...	2	int16	int16	int16	90	0
RTW_OP_MINUS	s16_sub_s16_s16	2	int16	int16	int16	90	0
RTW_OP_MINUS	s8_sub_s8_s8	2	int8	int8	int8	90	1
RTW_OP_MINUS	s16_sub_s16_s16...	2	int16	int16	int16	90	0
RTW_OP_MINUS	s32_sub_s32_s32	2	int32	int32	int32	90	1
RTW_OP_MINUS	u32_sub_u32_u32	2	uint32	uint32	uint32	90	2

RTW_OP_ADD	
General Information	
Trace Information	
Hit Source Locations:	
Source Location	
rtwdemo_crladdsub/CharAdd16:1	
rtwdemo_crladdsub/CharAdd16:1	
Miss Source Locations:	
Source Location	Miss Reason
rtwdemo_crladdsub/Add16	Mismatched rounding mode: actual 'RTW_ROUND_SIMPLEST', expected 'RTW_ROUND_CEILING'.
rtwdemo_crladdsub/Add8	Mismatched saturation mode: actual 'RTW_WRAP_ON_OVERFLOW', expected 'RTW_SATURATE_ON_OVERFLOW'.

The **Trace Information** tab lists **Hit Source Locations** and **Miss Source Locations**. Notice that the usage count for the entry is 2, and that the **Trace Information** tab lists 2 hits and 2 misses in the most recent code generation. The display provides links to each source location (the source block for which code replacement was considered) and, for misses, lists a **Miss Reason**. In the display above, in one case a saturation mode setting did not match between the CRL entry and the source block, and in another case the signedness attribute did not match. If an expected replacement did not occur, you can use the hit and miss information to modify the match criteria in the CRL table entry.

View Cache Hits and Misses Using Command-Line

To display the CRL cache hits and misses logged during the most recent code generation session in the MATLAB Command Window, use the following command:

```
>> crl=get_param('model', 'TargetFcnLibHandle')
```

The resulting display includes the following fields:

Field	Description
HitCache	Table containing function entries that were matched during a code generation session. These entries represent function implementations that should appear in the generated code.
MissCache	Table containing function entries that failed to match during a code generation session. These entries are created by the code generation process for the purpose of querying the CRL to locate a registered implementation. If there is a registered implementation that you feel should have been used in the generated code and was not, examining the MissCache for entries that are similar but did not match can help you locate discrepancies in a conceptual argument list or in table entry attributes.

In the following example, the most recent code generation session logged one cache hit and zero cache misses. You can examine the logged HitCache entry using its table index.

```
>> a=get_param('sinefcn','TargetFcnLibHandle')

a =

RTW.Tf1Control
    Version: '1.0'
    HitCache: [1x1 RTW.Tf1CFunctionEntry]
    MissCache: [0x1 handle]
    TLCCallList: [0x1 handle]
    Tf1Tables: [2x1 RTW.Tf1Table]

>> a.HitCache(1)

ans =

RTW.Tf1CFunctionEntry
    Key: 'sin'
    Priority: 100
    ConceptualArgs: [2x1 RTW.Tf1ArgNumeric]
    Implementation: [1x1 RTW.CImplementation]
    RTWmakecfgLibName: ''
```

```
        GenCallback: ''
        GenFileName: ''
        SaturationMode: 'RTW_SATURATE_UNSPECIFIED'
        RoundingModes: {'RTW_ROUND_UNSPECIFIED'}
        AcceptExprInput: 1
        SideEffects: 0
        UsageCount: 2
        SharedUsageCount: 0
        Description: ''
            ImplType: 'FCN_IMPL_FUNCT'
        AdditionalHeaderFiles: {0x1 cell}
        AdditionalIncludePaths: {0x1 cell}
        AdditionalSourceFiles: {0x1 cell}
        AdditionalSourcePaths: {0x1 cell}
        AdditionalLinkObjs: {0x1 cell}
        AdditionalLinkObjsPaths: {0x1 cell}
```

>>

Register Code Replacement Libraries

In this section...

“Overview of CRL Registration” on page 23-203

“Register CRL with Simulink Software (sl_customization)” on page 23-204

“Register CRL with MATLAB® Coder™ Software (rtwTargetInfo)” on page 23-208

“Register Multiple CRLs” on page 23-210

Overview of CRL Registration

After you define function and operator replacements in a code replacement library (CRL) table definition file, your table can be included in a CRL that you register either with Simulink software or with MATLAB Coder software. When a CRL is registered, it appears in the **Code replacement library** drop-down list on the **Code Generation > Interface** pane of the Simulink Configuration Parameters dialog box or on the **Hardware** pane of the MATLAB Coder Project Settings dialog box. You can select it from the **Code replacement library** drop-down list for use in code generation.

To register CRLs with Simulink software, use the Simulink customization file `sl_customization.m`. This file is a mechanism that allows you to use MATLAB code to perform customizations of the standard Simulink user interface. The Simulink software reads the `sl_customization.m` file, if present on the MATLAB path, when it starts and the customizations specified in the file are applied to the Simulink session. For more information on the `sl_customization.m` customization file, see “Registering Customizations”.

To register CRLs with MATLAB Coder software, use the MATLAB Coder customization file `rtwTargetInfo.m`. This file is a mechanism that allows you to use MATLAB code to perform customizations of the standard MATLAB Coder project settings. The MATLAB Coder software reads the `rtwTargetInfo.m` file, if present on the MATLAB path, when it starts and the customizations specified in the file are applied to the MATLAB Coder session.

Note

- This section describes MATLAB based APIs used to register a CRL. You also can register a CRL using the Code Replacement Tool graphical interface. The Code Replacement Tool generates registration code into an `rtwTargetInfo.m` customization file. For more information, see “Manage CRTs with the Code Replacement Tool” on page 23-168.
 - The `rtwTargetInfo.m` customization file works equally well for MATLAB or Simulink code generation, while the `sl_customization.m` customization file works only for Simulink code generation.
 - MATLAB Coder does not support TLC callbacks.
-

Register CRL with Simulink Software (`sl_customization`)

To register a CRL, you create an instance of `sl_customization.m` and include it on the MATLAB path of the Simulink installation that you want to customize. The `sl_customization` function accepts one argument: a handle to a customization manager object. The function is declared as follows:

```
function sl_customization(cm)
```

The body of the `sl_customization` function invokes the `registerTargetInfo(crl)` method to register one or more CRLs with the Simulink software. Typically, the `registerTargetInfo` function call references a local function that defines the CRLs to be registered. For example:

```
    % Register the CRL defined in local function locCrlRegFcn
    cm.registerTargetInfo(@locCrlRegFcn);

end % End of SL_CUSTOMIZATION
```

Below the `sl_customization` function, the referenced local function describes one or more CRLs to be registered. For example, you can declare the local function as follows:

```
% Local function to define a CRL
function thisCr1 = locCr1RegFcn
```

In the local function body, for each CRL to be registered, you instantiate a CRL registry entry using `cr1 = RTW.Tf1Registry`. For example,

```
    thisCr1 = RTW.Tf1Registry;
```

Then, you define the CRL properties shown in the following table within the registry entry.

CRL Property	Description
Name	String specifying the name of the CRL, as it should be displayed in the Code replacement library drop-down list on the Code Generation > Interface pane of the Configuration Parameters dialog box.
Description	String specifying a text description of the CRL, as it should be displayed in the tool tip for the CRL in the Configuration Parameters dialog box.
TableList	Cell array of strings specifying the tables that make up the CRL, in descending priority order. Tables can be specified in the following ways: <ul style="list-style-type: none"> • Name of a CRL table file on the MATLAB search path • Absolute path to a table file • Path to a table file relative to \$(MATLAB_ROOT) See “Register Multiple CRLs” on page 23-210 for examples of each type of table specification.

CRL Property	Description
BaseTf1	<p>String specifying the name of the CRL on which this CRL is based.</p> <hr/> <p>Note You must specify one of the default MathWorks libraries as the base CRL: 'C89/C90 (ANSI)', 'C99 (ISO)', 'GNU99 (GNU)', 'C++ (ISO)', or an equivalent alias. Doing this provides coverage of the functions, macros, and constants used by built-in blocks in your CRL, and supports compatibility between releases.</p> <hr/>
TargetHWDeviceType	Specify {'*'}
LanguageConstraint	Cell array of strings specifying language constraint keywords. You must specify {'C++'} if your CRL includes C++ function entries or a mix of C and C++ function entries. Otherwise you can omit the field or specify it as empty.
TargetCharacteristics	Contains properties that can be used to describe target characteristics, including the DataAlignment property. You can use the DataAlignment property to provide compiler information to support data alignment for function implementations in your CRL. For more information, see “Configure Data Alignment for Function Implementations” on page 23-120. If you are not configuring data alignment for your CRL, you can omit this field.

For example:

```

thisCrl.Name = 'Sine Function Example';
thisCrl.Description = 'Example of sine function replacement';
thisCrl.TableList = {'crl_table_sinfcn'};
thisCrl.BaseTf1 = 'C89/C90 (ANSI)';
thisCrl.TargetHWDeviceType = {'*'};

```

```
end % End of LOCCRLREGFCN
```

Combining the elements described in this section, the complete `sl_customization` function for the Sine Function Example CRL would appear as follows:

```
function sl_customization(cm)
% sl_customization function to register a code replacement library (CRL)
% for use with Simulink

    % Register the CRL defined in local function locCrlRegFcn
    cm.registerTargetInfo(@locCrlRegFcn);

end % End of SL_CUSTOMIZATION

% Local function to define a CRL containing crl_table_sinfcn
function thisCrl = locCrlRegFcn

    % Instantiate a CRL registry entry
    thisCrl = RTW.Tf1Registry;

    % Define the CRL properties
    thisCrl.Name = 'Sine Function Example';
    thisCrl.Description = 'Example of sine function replacement';
    thisCrl.TableList = {'crl_table_sinfcn'};
    thisCrl.BaseTf1 = 'C89/C90 (ANSI)';
    thisCrl.TargetHWDDeviceType = {'*'};

end % End of LOCCRLREGFCN
```

If you place the `sl_customization.m` file containing this function in the MATLAB search path or in the current working folder, the CRL is registered at each Simulink startup. The Simulink software will display the CRL in the **Code replacement library** drop-down list on the **Code Generation > Interface** pane of the Configuration Parameters dialog box. For example, the following figure shows the Configuration Parameters dialog box display for the Sine Function Example CRL.

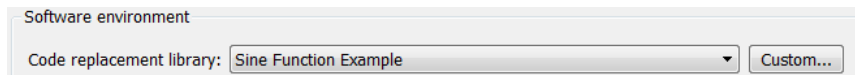

If you hover over the selected library with the cursor, a tool tip appears, and displays the CRL description and the list of tables it contains.

Tip

- To refresh Simulink customizations within the current MATLAB session, use the command `sl_refresh_customizations`.
- To list `sl_customization` files in the current search path, use the command `which sl_customization -all`.
- If you disable a CRL registration (for example, by renaming the registration file `sl_customization.m` and then issuing `sl_refresh_customizations`), you may want to reset and save the **Code replacement library** option setting in saved models that selected the disabled CRL.

Register CRL with MATLAB Coder Software (rtwTargetInfo)

To register a CRL for use with MATLAB Coder software, you create an instance of `rtwTargetInfo.m` and include it on the MATLAB path of the MATLAB Coder installation that you want to customize. The `rtwTargetInfo` function accepts one argument: a handle to a target registration object. The function is declared as follows:

```
function rtwTargetInfo(tr)
```

Note MATLAB Coder does not support TLC callbacks.

The body of the `rtwTargetInfo` function invokes the `registerTargetInfo(crl)` method provided by the target registry object to register one or more CRLs with the MATLAB Coder software. Typically, the `registerTargetInfo` function call references a local function that defines the CRLs to be registered. For example:

```

    % Register the CRL defined in local function locCrlRegFcn
    tr.registerTargetInfo(@locCrlRegFcn);

end % End of RTWTARGETINFO

```

Below the `rtwTargetInfo` function, the referenced local function describes one or more CRLs to be registered. The format exactly matches the CRL description format previously described for Simulink use. For example, here is the MATLAB Coder equivalent of the complete CRL registration file displayed in “Register CRL with Simulink Software (`sl_customization`)” on page 23-204.

```

function rtwTargetInfo(tr)
% rtwTargetInfo function to register a code replacement library (CRL)
% for use with codegen

    % Register the CRL defined in local function locCrlRegFcn
    tr.registerTargetInfo(@locCrlRegFcn);

end % End of RTWTARGETINFO

% Local function to define a CRL containing crl_table_sinfcn
function thisCrl = locCrlRegFcn

    % Instantiate a CRL registry entry
    thisCrl = RTW.Tf1Registry;

    % Define the CRL properties
    thisCrl.Name = 'Sine Function Example';
    thisCrl.Description = 'Example of sine function replacement';
    thisCrl.TableList = {'crl_table_sinfcn'};
    thisCrl.BaseTf1 = 'C89/C90 (ANSI)';
    thisCrl.TargetHWDDeviceType = {'*'};

end % End of LOCCRLREGFCN

```

If you place the `rtwTargetInfo.m` file containing this function in the MATLAB search path or in the current working folder, the CRL is registered at each MATLAB Coder startup. The MATLAB Coder software will display

the CRL in the **Code replacement library** drop-down list on the **Code Generation > Interface** pane of the Configuration Parameter dialog box.

Tip To refresh MATLAB Coder CRL registration information within the current MATLAB session, use the command `RTW.TargetRegistry.getInstance('reset');`

Register Multiple CRLs

For an example of a CRL registration file that registers multiple CRLs, see the `sl_customization.m` file used in the CRL example `rtwdemo_crl_script`. The following example illustrates the general approach, which applies equally to Simulink and MATLAB Coder CRL registration files. In this example, the three CRL tables referenced in the `TableList` fields reside at different locations, either on the MATLAB search path or at locations specified using path strings.

```
function sl_customization(cm)

    cm.registerTargetInfo(@locCrlRegFcn);

end % End of SL_CUSTOMIZATION

% Local function(s)
function thisCrl = locCrlRegFcn
    % Register a Code Replacement Library for use with model: rtwdemo_crladdsub
    thisCrl(1) = RTW.Tf1Registry;
    thisCrl(1).Name = 'Addition & Subtraction Examples';
    thisCrl(1).Description = 'Example of addition/subtraction op replacement';
    thisCrl(1).TableList = {'crl_table_addsub'};
    thisCrl(1).BaseTf1 = 'C89/C90 (ANSI)';
    thisCrl(1).TargetHWDeviceType = {'*'};

    % Register a Code Replacement Library for use with model: rtwdemo_crlmuldiv
    thisCrl(2) = RTW.Tf1Registry;
    thisCrl(2).Name = 'Multiplication & Division Examples';
    thisCrl(2).Description = 'Example of mult/div op repl for built-in integers';
    thisCrl(2).TableList = {'c:/work_crl/crl_table_muldiv'};
    thisCrl(2).BaseTf1 = 'C89/C90 (ANSI)';
```



```
thisCr1(2).TargetHWDeviceType = {'*'};

% Register a Code Replacement Library for use with model: rtwdemo_crlfixpt
thisCr1(3) = RTW.TflRegistry;
thisCr1(3).Name = 'Fixed-Point Examples';
thisCr1(3).Description = 'Example of fixed-point operator replacement';
thisCr1(3).TableList = ...
{fullfile('${MATLAB_ROOT}','toolbox','rtw','rtwdemos','crl_demo','crl_table_fixpt')};
thisCr1(3).BaseTfl = 'C89/C90 (ANSI)';
thisCr1(3).TargetHWDeviceType = {'*'};

end % End of LOCCRLREGFCN
```

Custom Code Substitution for MATLAB Functions Using Code Replacement Libraries

The `coder.replace` function provides the ability to replace a specified MATLAB function with a code replacement library (CRL) function in the generated code. You can use `coder.replace` in MATLAB code from which you want to generate C code using MATLAB Coder and in MATLAB code in a MATLAB Function block.

You can replace MATLAB functions that have:

- Single or multiple inputs
- Single or multiple outputs
- Scalar and matrix inputs and outputs

Supported types include:

- `single`, `double` (complex and non-complex)
- `int8`, `uint8` (complex and non-complex)
- `int16`, `uint16` (complex and non-complex)
- `int32`, `uint32` (complex and non-complex)
- Fixed-point integers
- Mixed types (different type on each input)

Replace MATLAB Function with Custom Code

At the Command Line Using the codegen Function

This example shows how to use code replacement libraries to replace a specified MATLAB function with a code replacement library (CRL) function in the generated code using the codegen function.

Prerequisites

To complete this example, you must install the following products:

- MATLAB
- MATLAB Coder
- Embedded Coder
- C compiler

For a list of supported compilers, see http://www.mathworks.com/support/compilers/current_release/.

Before generating C code, you must set up the C compiler. See “Setting Up the C/C++ Compiler”.

For instructions on installing MathWorks products, see the MATLAB installation documentation. If you have installed MATLAB and want to check which other MathWorks products are installed, in the MATLAB Command Window, enter `ver` .

Create MATLAB Functions

- 1 Create a MATLAB function that uses `coder.replace`, for example:

```
function y = foo(u)    %#codegen
    coder.replace('-errorifnoreplacement');
    y=sin(u);
end
```

2. Create another function that calls `foo`:

```
function y = bar(u) %#codegen
    y=foo(u);
end
```

Create a Table of Replacement Function Entries

- 1 Create a file named `crl_table_foo.m` that describes the function entries for a Code Replacement Library table. The replacement function `sin_dbl.c` and header file `sin_dbl.h` must be on the path.

```
function hLib = crl_table_foo
hLib = RTW.TflTable;

%----- entry: foo -----
hEnt = RTW.TflCFunctionEntry;
hEnt.setTflCFunctionEntryParameters( ...
    'Key', 'foo', ...
    'Priority', 100, ...
    'ImplementationName', 'sin_dbl', ...
    'ImplementationHeaderFile', 'sin_dbl.h', ...
    'ImplementationSourceFile', 'sin_dbl.c')
% Conceptual Args

arg = hEnt.getTflArgFromString('y1','double');
arg.IOType = 'RTW_IO_OUTPUT';
hEnt.addConceptualArg(arg);

arg = hEnt.getTflArgFromString('u1','double');
hEnt.addConceptualArg(arg);

% Implementation Args

arg = hEnt.getTflArgFromString('y1','double');
arg.IOType = 'RTW_IO_OUTPUT';
hEnt.Implementation.setReturn(arg);

arg = hEnt.getTflArgFromString('u1','double');
hEnt.Implementation.addArgument(arg);

%arg = hEnt.getTflArgFromString('y1','double*');
```

```
%arg.IOType = 'RTW_IO_OUTPUT';
%hEnt.Implementation.addArgument(arg);

hLib.addEntry( hEnt );
```

- 2 View the replacement table.

```
RTW.viewTfl(crl_table_foo)
```

The Code Replacement Viewer displays the specified table.

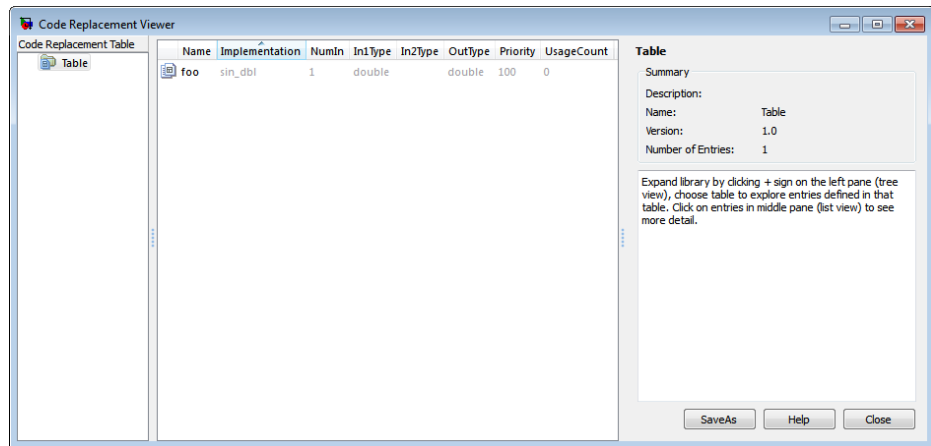

Register a Code Replacement Library

Register a code replacement library using an `rtwTargetInfo.m` file.

- 1 Create an `rtwTargetInfo` file:

```
function rtwTargetInfo(tr)
% rtwTargetInfo function to register a code replacement library (CRL)
% for use with codegen

% Register the CRL defined in local function locCrlRegFcn
tr.registerTargetInfo(@locCrlRegFcn);

end % End of RTWTARGETINFO
```

2 Create a `locCrlRegFcn` file:

```
function thisCrl = locCrlRegFcn

    % Instantiate a CRL registry entry
    thisCrl = RTW.TflRegistry;

    % Define the CRL properties
    thisCrl.Name = 'My foo Example';
    thisCrl.Description = 'Example of function replacement';
    thisCrl.TableList = {'crl_table_foo'};
    thisCrl.BaseTfl = 'C89/C90 (ANSI)';
    thisCrl.TargetHWDeviceType = {'*'};

end % End of LOCCRLREGFCN
```

3 Refresh registration information. At the MATLAB command line, enter:

```
RTW.TargetRegistry.getInstance('reset');
```

Specify Code Replacement Library to Use for Code Generation

Set up code generation configuration object to use the My foo Example code replacement library. At the MATLAB command line, enter:

```
cfg = coder.config('lib');
cfg.CodeReplacementLibrary='My foo Example';
```

Enable Code Replacements Report

The Code Replacements report summarizes the replacements used from the selected code replacement library.

```
cfg.GenerateCodeReplacementReport=true;
```

Generate Code

Generate C code only and create a code generation report. At the MATLAB command line, enter:

```
codegen -report -config cfg -c bar -args {0}
```

View the Generated Code

In the MATLAB command window, click the link to the code generation report. The generated code for the bar function contains the replacement function for foo.

```
real_T bar(real_T u)
{
    return sin_dbl(u);
}
```

View the Code Replacements Report

In the Code Generation Report, click the **Code Replacements Report** link. The Code Replacements Report provides a mapping between each code replacement instance and the line of MATLAB code that triggered the replacement.

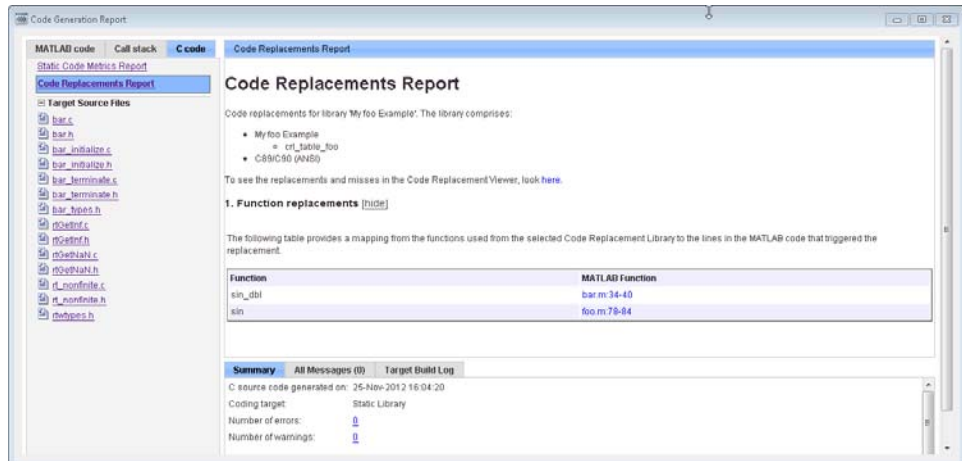

Specify a Code Replacement Function in a MATLAB Coder Project

- 1 On the project **Build** tab, set the **Output type** to generate a library or executable.
- 2 Click the **More settings** link.

- 3 In the **Project Settings** dialog box, select the **Hardware** tab.
- 4 On the **Hardware** tab, set **Code replacement library** to the replacement library that you want to use.

Enable the Code Replacements Report

In a MATLAB Coder Project

- 1 On the project **Build** tab, set the **Output type** to generate a library or executable.
- 2 Click the **More settings** link.
- 3 In the Project Settings dialog box, select the **Debugging** tab.
- 4 On the **Debugging** tab, select **Code replacements**.

At the Command Line

- 1 Create a code generation configuration object for standalone code generation. For example, to generate a static library:

```
cfg = coder.config('lib');
```

- 2 Set up code generation configuration object to use a code replacement library. For example:

```
cfg.CodeReplacementLibrary='My foo Example';
```

- 3 Generate code, passing the configuration object as a parameter and specifying the `-report` option. For example:

```
codegen -config cfg -report foo
```

Alternatively,

- 1 Create a code generation configuration object for a library or executable. For example, for a static library, at the command line, enter:

```
cfg=coder.config('lib');
```

- 2 Set up code generation configuration object to use a code replacement library. For example:

```
cfg.CodeReplacementLibrary='My foo Example';
```

- 3 Set the configuration object `GenerateReport` and `GenerateCodeReplacementReport` parameters to `true`.

```
cfg.GenerateReport=true;  
cfg.GenerateCodeReplacementReport=true;
```

See Also

- “Replace MATLAB Function with Custom Code” on page 23-213
- “Viewing Code Replacements in the Generated Code” on page 23-221

Viewing Code Replacements in the Generated Code

When you generate standalone C code from MATLAB code, you can select to generate a Code Replacements report. This report details the code replacement library functions that were used for code replacements during code generation. It provides a mapping between each replacement instance and the line of MATLAB code that triggered the replacement. The Code Replacements report is not available for generated MEX functions.

When you choose to include code replacements in the code generation report:

- The code generation report includes a link to the Code Replacements Report.
- Code replacement trace information is generated for viewing in the **Trace Information** tab of the Code Replacement Viewer.
- The code replacements report lists replacement functions and their associated MATLAB code.

You can use the report to:

- Determine which replacement functions were used in the generated code.
- Trace each replacement instance back to the code that triggered the replacement.

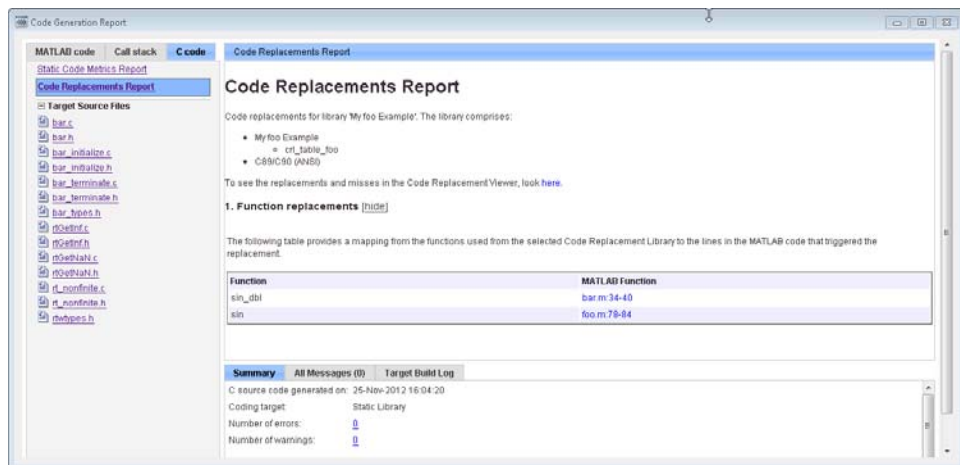

The screenshot shows the 'Code Replacements Report' window. The left sidebar lists 'Target Source Files' including various C and H files like 'bar.c', 'bar.h', 'm2cutil.c', etc. The main content area is titled 'Code Replacements Report' and contains the following text:

Code replacements for library 'My foo Example'. The library comprises:

- My foo Example
 - cri_table_foo
 - C89/C90 (ANSI)

To see the replacements and misses in the Code Replacement Viewer, look [here](#).

1. Function replacements [\[hide\]](#)

The following table provides a mapping from the functions used from the selected Code Replacement Library to the lines in the MATLAB code that triggered the replacement.

Function	MATLAB Function
sin_dbl	bar.m:34-40
sin	foo.m:78-84

At the bottom, there is a 'Summary' section with the following information:

C source code generated on: 25-Nov-2012 16:04:20
 Coding target: Static Library
 Number of errors: [0](#)
 Number of warnings: [0](#)

See Also

- “Enable the Code Replacements Report” on page 23-219
- “Replace MATLAB Function with Custom Code” on page 23-213

Replace MATLAB Function Block Code with Custom Code

This example shows how to use code replacement libraries to replace a specified **MATLAB** function with a code replacement library (CRL) function in the generated code.

Prerequisites

To complete this example, you must install the following products:

- MATLAB
- MATLAB Coder
- Simulink Coder
- Embedded Coder
- Third-party software

To compile and build generated code for the integration and testing tutorials, you can use an Integrated Development Environment (IDE) or equivalent tools such as command-line compilers and makefiles. For information on how to install and use the Eclipse™ IDE for C/C++ Developers and the Cygwin™ debugger for integrating and testing your generated code, see “Installing Eclipse IDE and Cygwin Debugger”.

Open the Simulink Model

Open the `ex_replace` model. At the MATLAB command line, enter:

```
addpath(fullfile(docroot, 'toolbox', 'ecoder', 'examples'))
ex_replace
```

View the MATLAB Function Block Code

In the model, double-click the MATLAB Function block to view the code in the MATLAB editor.

```
function y = customFcn(u1, u2) %#codegen
% This block supports MATLAB for code generation.

% Replace this MATLAB function with CRL replacement function and if no
```

```

% CRL replacement is found, generate an error during code generation.
coder.replace('-errorifnoreplacement');

assert(isa(u1,'int32'));
assert(isa(u2,'int32'));

y = power(u1,u2);

```

The `coder.replace('-errorifnoreplacement')` statement instructs Embedded Coder software to replace this MATLAB function with a code replacement library function and, if no CRL replacement is found, generate an error during code generation.

Create a Table of Replacement Function Entries

- 1 In a local, writable folder create a file named `crl_table_coderreplace.m` that describes the function entries for a Code Replacement Library table. Create a file `MyMath.c` and header file `MyMath.h` that contain the replacement function.

```

function hLib = crl_table_coderreplace

hLib = RTW.TflTable;

%----- entry: customFcn -----
hEnt = RTW.TflCFnFunctionEntry;
hEnt.setTflCFnFunctionEntryParameters( ...
    'Key', 'customFcn', ...
    'Priority', 100, ...
    'ImplementationName', 'scalarFcnReplacement', ...
    'ImplementationHeaderFile', 'MyMath.h', ...
    'ImplementationSourceFile', 'MyMath.c')
% Conceptual Args

arg = hEnt.getTflArgFromString('y1','int32');
arg.IOType = 'RTW_IO_OUTPUT';
hEnt.addConceptualArg(arg);

arg = hEnt.getTflArgFromString('u1','int32');
hEnt.addConceptualArg(arg);

```

```

arg = hEnt.getTf1ArgFromString('u2','int32');
hEnt.addConceptualArg(arg);

% Implementation Args

arg = hEnt.getTf1ArgFromString('void','void');
arg.IOType = 'RTW_IO_OUTPUT';
hEnt.Implementation.setReturn(arg);

arg = hEnt.getTf1ArgFromString('u1','int32');
hEnt.Implementation.addArgument(arg);

arg = hEnt.getTf1ArgFromString('u2','int32');
hEnt.Implementation.addArgument(arg);

arg = hEnt.getTf1ArgFromString('y1','int32*');
arg.IOType = 'RTW_IO_OUTPUT';
hEnt.Implementation.addArgument(arg);

hLib.addEntry( hEnt );

```

- 2** In the same folder, create files `MyMath.c` and `MyMath.h` that define the replacement function, `scalarFcnReplacement` which has two `int32` inputs and one `int32` output.

`MyMath.c`

```

#include "MyMath.h"

void scalarFcnReplacement(int32_T u1, int32_T u2, int32_T* y1 ) {
    *y1 = u1^u2;
}

```

`MyMath.h`

```

#ifndef _ScalarMath_h
#define _ScalarMath_h

#include "rtwtypes.h"

```

```

#ifdef __cplusplus
extern "C" {
#endif

extern void scalarFcnReplacement(int32_T u1, int32_T u2, int32_T* y1);

#ifdef __cplusplus
}
#endif

#endif

```

- 3 View the replacement table.

```
RTW.viewTf1(cr1_table_coderreplace)
```

The Code Replacement Viewer displays a list of currently registered code replacement tables.

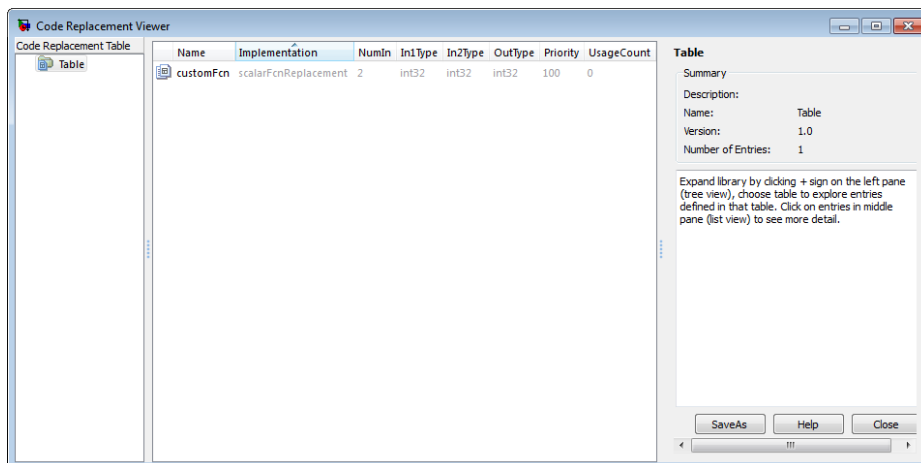

Register a Code Replacement Library

Register a code replacement library using a `rtwTargetInfo.m` file.

- 1 Create a `rtwTargetInfo` file:

```
function rtwTargetInfo(tr)
    tr.registerTargetInfo(@locCrlRegFcn);

end % End of RTWTARGETINFO
```

2 Create a locCrlRegFcn file:

```
function thisCrl = locCrlRegFcn

    % Register a Code Replacement Library for use with model 'ex_replace'
    thisCrl = RTW.Tf1Registry;
    thisCrl.Name = 'Coder Replace Examples';
    thisCrl.Description = 'Replace MATLAB code using CRL';
    thisCrl.TableList = {'crl_table_coderreplace'};
    thisCrl.BaseTf1 = 'C89/C90 (ANSI)';
    thisCrl.TargetHWDeviceType = {'*'};

end % End of LOCCRLREGFCN
```

3 Refresh registration information. At the MATLAB command line, enter:

```
RTW.TargetRegistry.getInstance('reset');
```

Verify Code Replacement Library to Use for Code Generation

1 In the model, select **Simulation > Model Configuration Parameters** to open the Configuration Parameters dialog box.

2 On the **Code Generation > Interface** pane, verify that **Code replacement library** is set to **Coder Replace Examples**.

Generate Code

From the model menu, select **Code > C/C++ Code > Build Model**.

View the Generated Code

In the code generation report, view the generated code `ex_replace.c`.

```
void ex_replace_step(void)
{
```

```
int32_T y;  
scalarFcnReplacement(ex_replace_U.In1, ex_replace_U.In2, &y);  
ex_replace_Y.Out1 = y;  
}
```

Code Replacement Library Limitations

- Code replacement library (CRL) replacement may behave differently than you expect in some cases. For example, data types that you observe in a model do not necessarily match what the code generator determines to use as intermediate data types in an operation. To verify whether you are obtaining the function or operator replacement that you expect, inspect the generated code.
- To analyze code replacement behavior, in addition to inspecting the generated code, you can use the following resources:
 - Code Replacement Viewer
 - HTML code generation reports, with bidirectional tracing including model-to-code highlighting, and the ability to map replacement functions to associated blocks
 - Information about CRL cache hits and misses logged during code generation

For more information on analyzing code replacement behavior, see “Examine and Validate Code Replacement Tables” on page 23-191.

- You must register a CRL in either an `sl_customization.m` file or an `rtwTargetInfo` file, but not in both files.
- For limitations that apply to MATLAB function code replacement, see `coder.replace`.

Performance

- Chapter 24, “Configuration”
- Chapter 25, “Data Copy Reduction”
- Chapter 26, “Execution Speed”
- Chapter 27, “Memory Usage”

Configuration

- “Configure Code Optimizations” on page 24-2
- “Set Hardware Implementation Parameters” on page 24-5
- “Use External Mode with the ERT Target” on page 24-6

Configure Code Optimizations

Several parameters available on the **Optimization** panes configure your model to optimize code generation. The following table includes parameters on the **Optimization > General** pane:

To...	Select or Specify...
Remove initialization code for root-level inports and outports with a value of zero	Select Remove root level I/O zero initialization .
Generate additional code to set float and double storage explicitly to value 0.0	Select Use memset to initialize floats and doubles to 0.0 When you set this parameter, the <code>memset</code> function clears internal storage (regardless of type) to the integer bit pattern 0 (that is, all bits are off). The additional code generated when the option is off, is slightly less efficient. If the representation of floating-point zero used by your compiler and target CPU is identical to the integer bit pattern 0, you can gain efficiency by setting this parameter.
Suppress the generation of code that initializes internal work structures (for example, block states and block outputs) to zero	Select Remove internal state zero initialization .
Generate run-time initialization code for a block that has states only if the block is in a system that can reset its states, such as an enabled subsystem	Select Optimize initialization code for model reference This results in more efficient code. The following restrictions apply to using the Optimize initialization code for model reference parameter. However, these restrictions do not apply to a Model block that references a function-call model. <ul style="list-style-type: none"> • In a subsystem that resets states, do not include a Model block that references a model that has this parameter set to on. For example, in an enabled subsystem with the States when enabling block parameter set to reset, do not include a Model block that references a model that has the Optimize initialization code for model reference parameter set to on.

To...	Select or Specify...
	<ul style="list-style-type: none"> If you set the Optimize initialization code for model reference parameter to off in a model that includes a Model block that directly references a submodel, do not set the Optimize initialization code for model reference parameter for the submodel to on.
Remove wrapping code that handles out-of-range floating-point to integer conversion results	Select Remove code from floating-point to integer conversions that wraps out-of-range values . This reduces the size and increases the speed of the generated code at the cost of potentially producing results that do not match simulation in the case of out-of-range values.
Suppress generation of code that guards against fixed-point division by zero	Select Remove code that protects against division arithmetic exceptions . When you select this parameter, simulation results and results from generated code may not be in bit-for-bit agreement.
To minimize the amount of memory allocated for absolute and elapsed time counters	Specify an integer value for Application lifespan (days) For more information on the allocation and operation of absolute and elapsed timers, see “Timers”, “Use Timers in Asynchronous Tasks”, and “Control Memory Allocation for Time Counters” in the Simulink Coder documentation.

The following table includes optimization parameters on the **Optimization > Signals and Parameters** pane:

To...	Select or Specify...
Control whether parameter data for reusable subsystems is generated in a separate header file for each subsystem or in a single parameter data structure	Select Hierarchical or NonHierarchical for Parameter structure .
Replace multiply operations in array indices when accessing arrays in a loop	Select Simplify array indexing .

To...	Select or Specify...
<p>Store Boolean signals as one-bit bitfields instead of as a Boolean data type</p>	<p>Select Pack Boolean data into bitfields. Selecting this parameter enables the Bitfield declarator type specifier. To optimize your code further, select <code>uchar_T</code>, however this optimization benefit is dependent on your choice of target.</p>
<p>Pass each reusable subsystem output argument as an address of a local to reduce global memory usage and eliminate copying local variables back to global block I/O structures</p>	<p>Select Individual arguments for Pass reusable subsystem outputs as.</p>

Set Hardware Implementation Parameters

Specification of target-specific characteristics of generated code (such as word sizes for char, short, int, and long data types, or desired rounding behaviors in integer operations) can be critical in embedded systems development. The **Hardware Implementation** category of options in a configuration set provides a simple and flexible way to control such characteristics in both simulation and code generation.

Before generating and deploying code, you should become familiar with the options on the **Hardware Implementation** pane of the Configuration Parameters dialog box. See “Hardware Implementation Pane” in the Simulink documentation and “Platform Options for Development and Deployment” in the Simulink Coder documentation for full details on the **Hardware Implementation** pane.

By configuring the **Hardware Implementation** properties of your model’s active configuration set to match the behaviors of your compiler and hardware, you can generate more efficient code. For example, if you specify the **Byte ordering** property, you can avoid generation of extra code that tests the byte ordering of the target CPU.

You can use the `rtwdemo_targetsettings` demo model to determine some implementation-dependent characteristics of your C or C++ compiler, as well as characteristics of your target hardware. By using this model in conjunction with your target development system and debugger, you can observe the behavior of the code as it executes on the target. You can then use this information to configure the **Hardware Implementation** parameters of your model.

To use this model, type the command

```
rtwdemo_targetsettings
```

Follow the instructions in the model window.

Use External Mode with the ERT Target

Selecting the **External mode** option turns on generation of code to support external mode communication between host (Simulink) and target systems. The Embedded Coder software supports Simulink external mode features, as described in the “Host/Target Communication” section of the Simulink Coder documentation.

This section discusses external mode options that may be of special interest to embedded systems designers. The next figure shows the **Data Exchange** subpane of the Configuration Parameters dialog box, **Interface** pane, with **External mode** selected.

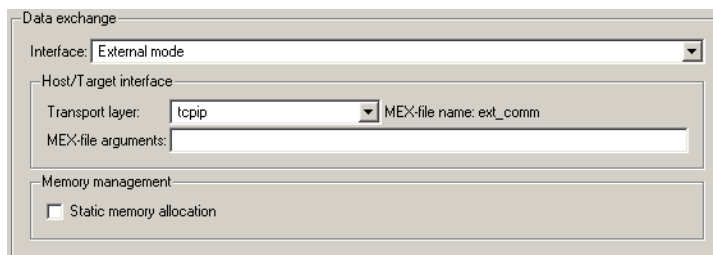

Memory Management

Consider the **Memory management** option **Static memory allocation** before generating external mode code for an embedded target. Static memory allocation is generally desirable, as it reduces overhead and promotes deterministic performance.

When you select the **Static memory allocation** option, static external mode communication buffers are allocated in the target application. When **Static memory allocation** is deselected, communication buffers are allocated dynamically (with `malloc`) at run time.

Generation of Pure Integer Code with External Mode

The Embedded Coder software supports generation of pure integer code when external mode code is generated. To do this, select the **External mode** option, and deselect the **Support floating-point numbers** option in the **Software environment** section of the **Interface** pane.

This enhancement lets you generate external mode code that is free of storage definitions of double or float data type, and allows your code to run on integer-only processors

If you intend to generate pure integer code with **External mode** on, note the following requirements:

- All trigger signals must be of data type `int32`. Use a Data Type Conversion block if needed.
- When pure integer code is generated, the simulation stop time specified in the **Solver** options is ignored. To specify a stop time, run your target application from the MATLAB command line and use the `-tf` option. (See “Run the External Program” in the Simulink Coder documentation.) If you do not specify this option, the application executes indefinitely (as if the stop time were `inf`).

When executing pure integer target applications, the stop time specified by the `-tf` command line option is interpreted as the number of base rate ticks to execute, rather than as an elapsed time in seconds. The number of ticks is computed as

$$\text{stop time in seconds} / \text{base rate step size in seconds}$$

Data Copy Reduction

- “Use Virtualized Output Ports Optimization” on page 25-2
- “Control Signal Storage” on page 25-4

Use Virtualized Output Ports Optimization

The *virtualized output ports* optimization lets you store the signal entering the root output port as a global variable. This eliminates code and data storage associated with root output ports when the **MAT-file logging** option is cleared and the TLC variable FullRootOutputVector equals 0, both of which are defaults for Embedded Coder targets.

To illustrate this feature, consider the model shown in the following block diagram. Assume that the signal exportedSig has exportedGlobal storage class.

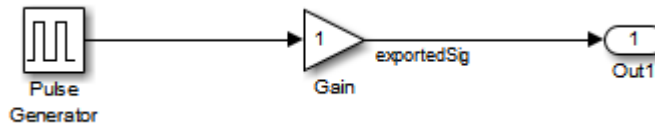

In the default case, the output of the Gain block is written to the signal storage location, `exportedSig`. The code generator does not generate code or data for the `Out1` block, which has become a virtual block. This is shown in the following code fragment.

```
/* Gain Block: <Root>/Gain */
    exportedSig = rtb_PulseGen * VirtOutPortLogOFF_P.Gain_Gain;
```

In cases where either the **MAT-file logging** option is enabled, or `FullRootOutputVector = 1`, the generated code represents root output ports as members of an external outputs vector.

The following code fragment was generated from the same model shown in the previous example, but with **MAT-file logging** enabled. The output port is represented as a member of the external outputs vector `VirtOutPortLogON_Y`. The Gain block output value is copied to both `exportedSig` and to the external outputs vector.

```
/* Gain Block: <Root>/Gain */
    exportedSig = rtb_PulseGen * VirtOutPortLogON_P.Gain_Gain;

/* Outport Block: <Root>/Out1 */
    VirtOutPortLogON_Y.Out1 = exportedSig;
```

The overhead incurred by maintenance of data in the external outputs vector can be significant for smaller models being used to perform benchmarks.

Note that you can force root output ports to be stored in the external outputs vector (regardless of the setting of **MAT-file logging**) by setting the TLC variable `FullRootOutputVector` to 1. You can do this by adding the statement

```
%assign FullRootOutputVector = 1
```

to the Embedded Coder system target file. Alternatively, you can enter the assignment with **TLC options** on the **Code Generation** pane of the Configuration Parameters dialog box.

For more information on how to control signal storage in generated code, see “Signals”.

Control Signal Storage

There are a number of options that let you control how signals in your model are stored and represented in the generated code. You can control whether signal storage is declared in global memory space, or locally in functions (that is, in stack variables).

For a complete discussion of signal storage options, see “Signals”.

If you want to store signals in stack space, you must turn the **Enable local block outputs** option on. To do this:

- 1** Select the **Optimization > Signals and Parameters** of the Configuration Parameters dialog box. Make sure that **Signal storage reuse** is selected. If **Signal storage reuse** is cleared, **Enable local block outputs** is not available.
- 2** Select the **Enable local block outputs** option. Click **Apply**.

Execution Speed

- “Remove Initialization Code” on page 26-2
- “Generate Pure Integer Code If Possible” on page 26-4
- “Disable MAT-File Logging” on page 26-5
- “Simplify Multiply Operations In Array Indexing” on page 26-6

Remove Initialization Code

Consider selecting the **Remove internal state zero initialization** and **Remove root level I/O zero initialization** options on the **Optimization > General** pane.

These options (both off by default) control whether internal data (block states and block outputs) and external data (root inports and outports whose value is zero) are initialized. Initializing the internal and external data whose value is zero is a precaution and your application might not require it. Many embedded application environments initialize RAM to zero at startup, making generation of initialization code redundant.

However, be aware that if you select **Remove internal state zero initialization**, memory might not be in a known state each time the generated code begins execution. If you turn the option on, running a model (or a generated S-function) multiple times can result in different answers for each run.

This behavior is sometimes desirable. For example, you can turn on **Remove internal state zero initialization** if you want to test the behavior of your design during a warm boot (that is, a restart without full system reinitialization).

In cases where you have turned on **Remove internal state zero initialization** but still want to get the same answer on every run from a S-function generated by the Embedded Coder software, you can use either of the following MATLAB commands before each run:

```
clear SFcnName
```

where *SFcnName* is the name of the S-function, or

```
clear mex
```

A related option, **Use memset to initialize floats and doubles**, lets you control the representation of zero used during initialization. See “Use memset to initialize floats and doubles to 0.0” in the Simulink reference documentation.

Note that the code still initializes data structures whose value is not zero when **Remove internal state zero initialization** and **Remove root level I/O zero initialization** are selected.

Note also that data of `ImportedExtern` or `ImportedExternPointer` storage classes are not initialized, regardless of the settings of these options.

Generate Pure Integer Code If Possible

If your application uses only integer arithmetic, clear the **Support floating-point numbers** option in the **Software environment** section of the **Interface** pane so that the generated code contains no floating-point data or operations. When this option is cleared, an error is raised if noninteger data or expressions are encountered during code generation. The error message reports the offending blocks and parameters.

Disable MAT-File Logging

Clear the **MAT-file logging** option in the **Verification** section of the **Interface** pane. This setting is the default, and is recommended for embedded applications because it eliminates the extra code and memory usage required to initialize, update, and clean up logging variables. In addition to these efficiencies, clearing the **MAT-file logging** option lets you exploit further efficiencies under certain conditions. See “Use Virtualized Output Ports Optimization” on page 25-2 for information.

Note also that code generated to support MAT-file logging invokes `malloc`, which may be undesirable for your application.

Simplify Multiply Operations In Array Indexing

The generated code might have multiply operations when indexing an element of an array. You can select the optimization parameter “Simplify array indexing” to replace multiply operations in the array index with a temporary variable. To modify this parameter open the Configuration Parameters dialog box and select the **Optimization > Signals and Parameters** pane. This optimization can improve execution speed by reducing the number of times the multiply operation is executed.

If you have the following model:

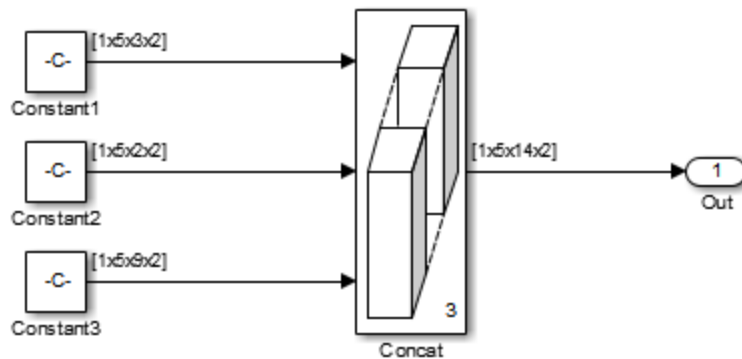

The Constant blocks have the following **Constant value**:

- Const1: `reshape(1:30,[1 5 3 2])`
- Const2: `reshape(1:20,[1 5 2 2])`
- Const3: `reshape(1:90,[1 5 9 2])`

The Concatenate block parameter **Mode** is set to `Multidimensional array`.

Generated Code Results

Building the model with the **Simplify array indexing** parameter turned off generates the following code:

```
int32_T i;
int32_T i_0;
```



```

int32_T i_1;

for (i = 0; i < 2; i++) {
  for (i_1 = 0; i_1 < 3; i_1++) {
    for (i_0 = 0; i_0 < 5; i_0++) {
      ex_arrayindex_Y.Out[(i_0 + 5 * i_1) + 70 * i] =
        ex_arrayindex_P.Constant1_Value[(5 * i_1 + i_0) + 15 * i];
    }
  }
}

for (i = 0; i < 2; i++) {
  for (i_1 = 0; i_1 < 2; i_1++) {
    for (i_0 = 0; i_0 < 5; i_0++) {
      ex_arrayindex_Y.Out[(i_0 + 5 * (i_1 + 3)) + 70 * i] =
        ex_arrayindex_P.Constant2_Value[(5 * i_1 + i_0) + 10 * i];
    }
  }
}

for (i = 0; i < 2; i++) {
  for (i_1 = 0; i_1 < 9; i_1++) {
    for (i_0 = 0; i_0 < 5; i_0++) {
      ex_arrayindex_Y.Out[(i_0 + 5 * (i_1 + 5)) + 70 * i] =
        ex_arrayindex_P.Constant3_Value[(5 * i_1 + i_0) + 45 * i];
    }
  }
}

```

After selecting the **Simplify array indexing** parameter and building the model again, a multiply operation in the array index, $[(i_0 + 5 * i_1) + 70 * i]$, is replaced with $[(i_0 + tmp_1) + tmp]$. The generated code is now:

```

int32_T i;
int32_T i_0;
int32_T i_1;
int32_T tmp;
int32_T tmp_0;
int32_T tmp_1;

```

```
tmp = 0;
tmp_0 = 0;
for (i = 0; i < 2; i++) {
    tmp_1 = 0;
    for (i_1 = 0; i_1 < 3; i_1++) {
        for (i_0 = 0; i_0 < 5; i_0++) {
            ex_arrayindex_Y.Out[(i_0 + tmp_1) + tmp] =
                ex_arrayindex_P.Constant1_Value[(i_0 + tmp_1) + tmp_0];
        }

        tmp_1 += 5;
    }

    tmp += 70;
    tmp_0 += 15;
}

tmp = 0;
tmp_0 = 0;
for (i = 0; i < 2; i++) {
    tmp_1 = 0;
    for (i_1 = 0; i_1 < 2; i_1++) {
        for (i_0 = 0; i_0 < 5; i_0++) {
            ex_arrayindex_Y.Out[((i_0 + tmp_1) + tmp) + 15] =
                ex_arrayindex_P.Constant2_Value[(i_0 + tmp_1) + tmp_0];
        }

        tmp_1 += 5;
    }

    tmp += 70;
    tmp_0 += 10;
}

tmp = 0;
tmp_0 = 0;
for (i = 0; i < 2; i++) {
    tmp_1 = 0;
    for (i_1 = 0; i_1 < 9; i_1++) {
```

```
for (i_0 = 0; i_0 < 5; i_0++) {  
    ex_arrayindex_Y.Out[((i_0 + tmp_1) + tmp) + 25] =  
        ex_arrayindex_P.Constant3_Value[(i_0 + tmp_1) + tmp_0];  
}  
  
    tmp_1 += 5;  
}  
  
tmp += 70;  
tmp_0 += 45;  
}
```

Memory Usage

- “Optimize Generated Code Using Specified Minimum and Maximum Values” on page 27-2
- “Reduce Global Variables in Nonreusable Subsystem Functions” on page 27-8

Optimize Generated Code Using Specified Minimum and Maximum Values

To optimize the generated code for your model, you can choose an option to use input range information, also known as *design minimum and maximum*, that you specify on signals and parameters. These minimum and maximum values usually represent environmental limits, such as temperature, or mechanical and electrical limits, such as output ranges of sensors.

When you select the **Optimize using specified minimum and maximum values** configuration parameter, the software uses the minimum and maximum values to derive range information for downstream signals in the model. It then uses this derived range information to determine if it is possible to streamline the generated code. For example, by:

- Reducing expressions to constants
- Removing dead branches of conditional statements
- Eliminating unnecessary mathematical operations

This optimization results in:

- Reduced ROM and RAM consumption
- Improved execution speed

How to Configure Your Model

To make optimization more likely:

- Provide as much design minimum and maximum information as possible. Specify minimum and maximum values for signals and parameters in the model for:
 - Inport and Outport blocks
 - Block outputs
 - Block inputs, for example, for the MATLAB Function and Stateflow Chart blocks
 - `Simulink.Signal` objects

- Before generating code, test the minimum and maximum values for signals and parameters. Otherwise, optimization might result in numerical mismatch with simulation. You can simulate your model with simulation range checking enabled. If errors or warnings occur, fix these issues before generating code.

How to Enable Simulation Range Checking

- 1** In your model, select **Simulation > Model Configuration Parameters** to open the Configuration Parameters dialog box.
 - 2** In the Configuration Parameters dialog box, select **Diagnostics > Data Validity**.
 - 3** On the **Data Validity** pane, under **Signals**, set **Simulation range checking** to warning or error.
- Provide design minimum and maximum information upstream of blocks as close to the inputs of the blocks as possible. If you specify minimum and maximum values for a block output, these values are most likely to affect the outputs of the blocks immediately downstream. For more information, see “Optimize Generated Code Using Specified Minimum and Maximum Values” on page 27-4.

How to Enable Optimization

- 1** Set the **Code Generation > System target file** configuration parameter to select an Embedded Real-Time (ERT) target (requires a Embedded Coder license).
- 2** Specify design minimum and maximum values for signals and parameters in your model using the tips in “How to Configure Your Model” on page 27-2.
- 3** Select the **Optimization > General Optimize using specified minimum and maximum values** configuration parameter.

For more information, see “Optimize using the specified minimum and maximum values” in the Simulink documentation.

Optimize Generated Code Using Specified Minimum and Maximum Values

This example demonstrates how the software uses specified input range information to determine whether it can eliminate unnecessary utility functions from the generated code. It uses the `rtwdemo_minmax` model.

Generate Code Without Using Specified Minimum and Maximum Values

First, generate code without taking into account the minimum and maximum values for the inputs to the Sum and Gain blocks or the minimum and maximum values for the Gain block parameter to see the code generated without the optimization.

- 1 Open the model. At the MATLAB command line, enter:

```
rtwdemo_minmax
```

- 2 Double-click the **View Optimization Configuration** button.

The **Optimization** pane of the Configuration Parameters dialog box appears.

On the **Code generation** panel, note that the **Optimize using specified minimum and maximum values** parameter is cleared.

- 3 Double-click the **Generate Code** button.

The code generation report appears.

- 4 In the left pane of the report, click the `rtwdemo_minmax.c` link.

The report displays the C code in the right pane.

The generated code for this model includes a branch for each of the Relational Operator block inputs.

```
void rtwdemo_minmax_step(void)
{
    if (U1 + U2 <= k * U3) {
        rtY.Out1 = (U1 + U2) + U3;
    }
}
```



```

} else {
    rtY.Out1 = U1 * U2 * U3;
}
}

```

Generate Code Using Minimum and Maximum Values

Next, enable the optimization and generate code for the model again, this time taking into account the design minimum and maximum values for the inputs to the Sum and Gain blocks and the minimum and maximum values for the Gain block parameter.

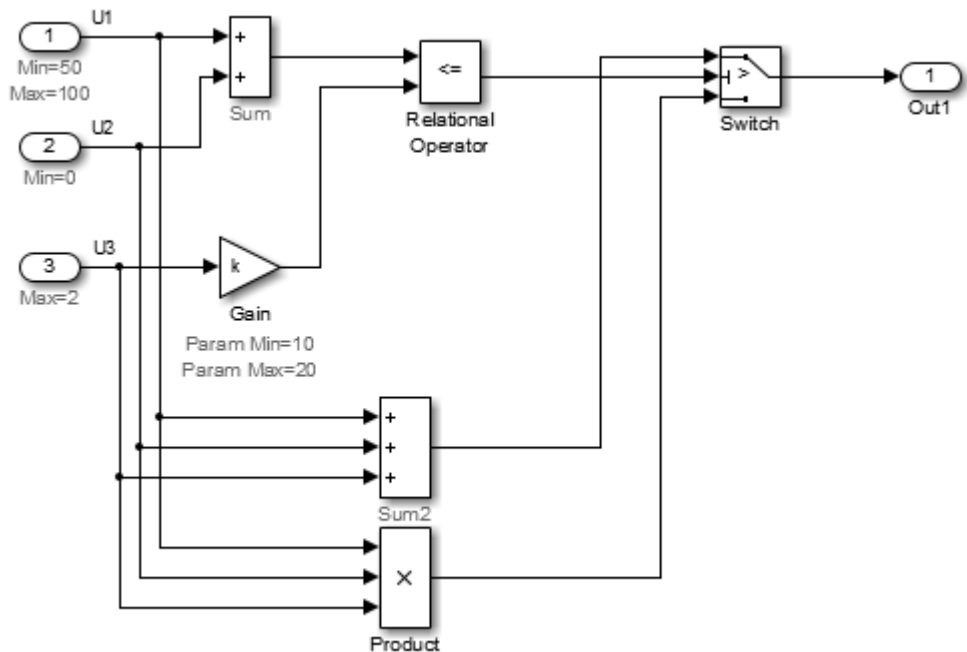

Note that:

- The minimum value of the first input to the Relational Operator block is 50 because this value is the minimum output from the Sum block.

- The maximum value of the second input to the Relational Operator block is 40 because this value is the maximum output of the Gain block.

Therefore, the output of the Relational Operator block is false, and the output of the Switch block is always the product of the three inputs.

- 1 Double-click the **View Optimization Configuration** button.

The Optimization pane of the Configuration Parameters dialog box appears.

- 2 On the **Code generation** panel, select the **Optimize using specified minimum and maximum values** parameter and click **Apply**.

- 3 Double-click the **Generate Code** button.

The code generation report appears.

- 4 In the left pane of the report, click the `rtwdemo_minmax.c` link and inspect the generated code. Using the minimum and maximum values, the software optimized the generated code by eliminating the conditional statement.

```
void rtwdemo_minmax_step(void)
{
    rtY.Out1 = U1 * U2 * U3;
}
```

Limitations

- This optimization does not take into account minimum and maximum values for:
 - Merge block inputs. To work around this issue, use a `Simulink.Signal` object on the Merge block output and specify the range on this object.
 - Bus elements.
 - Conditionally-executed subsystem (such as a triggered subsystem) block outputs that are directly connected to an Output block.

Output blocks in conditionally-executed subsystems can have an initial value specified for use only when the system is not triggered. In this case, the optimization cannot use the range of the block output because the range might not cover the initial value of the block.

- If you use Polyspace software to verify code generated using this optimization, it might mark code that was previously green as orange. For example, if your model contains a division where the range of the denominator does not include zero, the generated code does not include protection against division by zero. Polyspace might mark this code orange because it does not have information about the minimum and maximum values for the inputs to the division.

The Polyspace Model Link products do automatically capture some minimum and maximum values specified in the MATLAB workspace, for example, for `Simulink.Signal` and `Simulink.Parameter` objects. In this example, to provide range information to the Polyspace software, use a `Simulink.Signal` object on the input of the division and specify a range that does not include zero.

The Polyspace Model Link products store these values in a Data Range Specification (DRS) file. However, they do not capture all minimum and maximum values in your Simulink model. To provide additional minimum and maximum information to Polyspace, you can manually define a DRS file.

- If you are using double-precision data types and the **Code Generation > Interface > Support non-finite numbers** configuration parameter is selected, this optimization does not occur.
- If your model contains multiple instances of a reusable subsystem and each instance uses input signals with different minimum and maximum values, this optimization might result in different generated code for each subsystem so code reuse does not occur. Without this optimization, code is generated once for the subsystem and shares this code among the multiple instances of the subsystem.
- The Model Advisor **Check safety-related optimization settings** check generates a warning if this option is selected. For many safety-critical applications, removing dead code automatically is unacceptable because doing so might make code untraceable. For more information, see **Check safety-related optimization settings**.

Reduce Global Variables in Nonreusable Subsystem Functions

In this section...

“Generate void-void Function” on page 27-8

“Generate Function with Arguments” on page 27-9

Global variables can increase memory requirements and reduce execution speed. To reduce global RAM for a nonreusable subsystem, you can generate a function interface that passes data through arguments instead of global variables. The Subsystem block parameter “Function interface” provides this option. To compare the outputs for the **Function interface** options, first generate a function for a subsystem with a void-void interface, and then generate a function with arguments.

Generate void-void Function

By default, when you configure a Subsystem block as a nonreusable function, it generates a void-void interface.

- 1 Open the example model `rtwdemo_roll`.
- 2 In the Simulink editor, select **Code > C/C++ Code > Code Generation Options**. The Configuration Parameters dialog box displays the **Code Generation** pane.
- 3 Set the **System target file** parameter to `ert.tlc`, and then click **Apply**.
- 4 Right-click the subsystem `RollAngleReference`. From the list select **Block Parameter (Subsystem)**. The is displayed.
- 5 In the Subsystem Block Parameter dialog box, select the **Treat as atomic unit** check box.
- 6 Click the **Code Generation** tab and set the **Function packaging** parameter to `Nonreusable function`.
- 7 Generate code and the static code metrics report for `rtwdemo_roll`. This model is configured to generate a code generation report and to open the

report automatically. For more information, see “Generate a Static Code Metrics Report for a Simulink Model” on page 18-28.

In the code generation report, in `rtwdemo_roll.c`, the generated code for subsystem `RollAngleReference` is similar to the following:

```
void RollAngleReference(void)
{
    if (fabs(rtU.Turn_Knob) < 3.0) {
        rtDWork.TKSwitch = rtDWork.FixPtUnitDelay1_DSTATE;
    } else {
        rtDWork.TKSwitch = rtU.Turn_Knob;
    }
    if (!rtU.AP_Eng) {
        if ((rtU.Phi >= 6.0) || (rtU.Phi <= -6.0)) {
            rtDWork.FixPtUnitDelay1_DSTATE = rtU.Phi;
        } else {
            rtDWork.FixPtUnitDelay1_DSTATE = 0.0;
        }
    }
}
```

In the static code metrics report, navigate to **Global Variables**. With the `void-void` option, the number of bytes for global variable `rtDWork` is 41. Next, generate the same function with the `Allow arguments` option to compare the results.

Generate Function with Arguments

To reduce global RAM, improve ROM usage and execution speed, generate a function that allows arguments:

- 1** Open the Subsystem Block Parameter dialog box for `RollAngleReference`.
- 2** Click the **Code Generation** tab. Set the **Function interface** parameter to `Allow arguments`.
- 3** Generate code and the static code metrics report for `rtwdemo_roll`.

In the code generation report, in `rtwdemo_roll.c`, the generated code for subsystem `RollAngleReference` is now similar to the following:

```
void RollAngleReference(real_T rtu_Turn_Knob, boolean_T rtu_AP_Eng,
                       real_T rtu_Phi, real_T *rty_Phi_Ref)
{
    if (fabs(rtu_Turn_Knob) < 3.0) {
        *rty_Phi_Ref = rtDWork.FixPtUnitDelay1_DSTATE;
    } else {
        *rty_Phi_Ref = rtu_Turn_Knob;
    }
    if (!rtu_AP_Eng) {
        if ((rtu_Phi >= 6.0) || (rtu_Phi <= -6.0)) {
            rtDWork.FixPtUnitDelay1_DSTATE = rtu_Phi;
        } else {
            rtDWork.FixPtUnitDelay1_DSTATE = 0.0;
        }
    }
}
```

In the static code metrics report, navigate to **Global Variables**. With the **Allow arguments** option set, the number of bytes for the global variable `rtDWork` is now 33.

Verification

- Chapter 28, “Code Tracing”
- Chapter 29, “Component Verification”
- Chapter 30, “Component Verification With a Real-Time Target Environment”
- Chapter 31, “Numerical Equivalence Checking”
- Chapter 32, “Code Coverage”
- Chapter 33, “Code Execution Profiling”

Code Tracing

- “About Code Tracing” on page 28-2
- “Format of Traceability Tags” on page 28-3
- “Trace Code to Model Objects Using Hyperlinks” on page 28-4
- “Trace Model Objects to Generated Code” on page 28-6
- “Reload Existing Traceability Information” on page 28-8
- “Customize Traceability Reports” on page 28-10
- “Generate a Traceability Matrix” on page 28-12
- “Traceability Limitations” on page 28-13

About Code Tracing

The Simulink Coder code generator produces the HTML code generation report for a model. The report includes the following resources that support code traceability:

- Code element hyperlinks (indicated with underlining) that you can use to trace through and toggle between generated source and header files.
- Tags in code comments that identify blocks from which lines of code are generated.

For more information, see

- “Format of Traceability Tags” on page 28-3
- Tracing code to blocks using `hilite_system`
- “Generate a Code Generation Report”

The Embedded Coder product extends traceability capabilities to support:

- “Trace Code to Model Objects Using Hyperlinks” on page 28-4
- “Trace Model Objects to Generated Code” on page 28-6
- “Reload Existing Traceability Information” on page 28-8
- “Customize Traceability Reports” on page 28-10

Format of Traceability Tags

A traceability tag appears in a comment above the corresponding line of generated code. The format of the tags is `<system>/block_name`, where

- *system* is one of the following:
 - The string `Root`
 - A unique system number assigned by the Simulink engine
- *block_name* is the name of the source block

The code generator documents the tags for a model in the comments section of the generated header file `model.h`. For example, the following comment appears in the header file for model, `foo`, that has a subsystem `Outer` and a nested subsystem `Inner`:

```
/* Here is the system hierarchy for this model.
 *
 * <Root> : foo
 * <S1>   : foo/Outer
 * <S2>   : foo/Outer/Inner
 */
```

Examples of Tagged Code

The following code shows a tag comment adjacent to a line of code. This code is generated from a Gain block at the root level of a source model:

```
/* Gain: '<Root>/UnDeadGain1' */
rtb_UnDeadGain1_h = dead_gain_U.In1 *
    dead_gain_P.UnDeadGain1_Gain;
```

The following code shows a tag comment adjacent to a line of code. This code is generated from a Gain block within a subsystem one level below the root level of the source model:

```
/* Gain: '<S1>/Gain' */
dead_gain_B.temp0 *= (dead_gain_P.s1_Gain_Gain);
```

Trace Code to Model Objects Using Hyperlinks

When using the Simulink Coder product, you can trace code to model objects using the `hilite_system` command. The Embedded Coder product simplifies traceability with the use of hyperlinks in HTML code generation reports. The reports display hyperlinks in “Regarding,” “Outport,” and other comment lines in generated code. You can highlight the corresponding block or subsystem in the model diagram by clicking the hyperlinks.

To use hyperlinks for tracing code to model objects:

- 1 Open the model and make sure it is configured for an ERT target.
- 2 In the Configuration Parameters dialog box, select **Code Generation > Report Create code generation report**. The parameter is selected by default. When selected, the parameter enables and selects **Open report automatically** and **Code-to-model**.

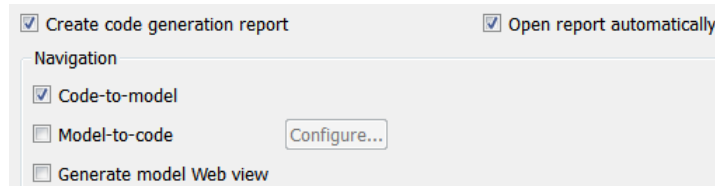

- 3 Build or generate code for the model. An HTML code generation report is displayed.
- 4 In the HTML report window, click hyperlinks to highlight source blocks. For example, generate an HTML report for model `rtwdemo_hyperlinks`. In the generated code for the model step function in `rtwdemo_hyperlinks.c`, click the first `UnitDelay` block hyperlink .

```

130  /* Model step function */
131  void rtwdemo_hyperlinks_step(void)
132  {
133      static real_T tmp[5] = { 10.0, -20.0, 30.0, -40.0, 50.0 };
134
135      /* Sum: '<Root>/Sum' incorporates:
136       * Constant: '<Root>/INC'
137       * Switch: '<Root>/Switch'
138       * UnitDelay: '<Root>/X'
139       * Update for UnitDelay: '<Root>/X'
140       */
141      rtDWork.X += 2.0;

```

In the model window, the corresponding UnitDelay block is highlighted.

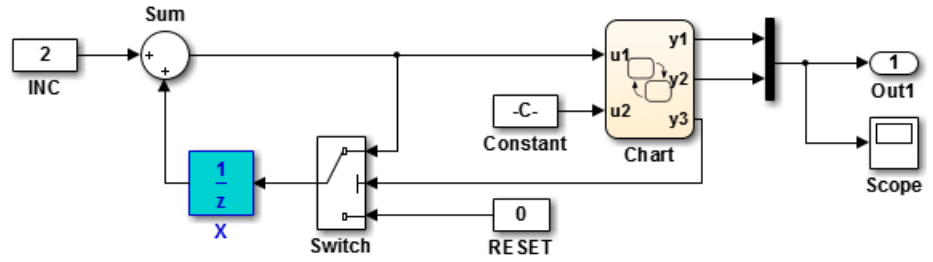

Trace Model Objects to Generated Code

To trace model objects to generated code:

- 1 Open the model and make sure it is configured for an ERT target.
- 2 In the Configuration Parameters dialog box, select **Code Generation > Report > Create code generation report**. The parameter is selected by default. When selected, the parameter enables and selects the **Open report automatically** and **Code-to-model** parameters.

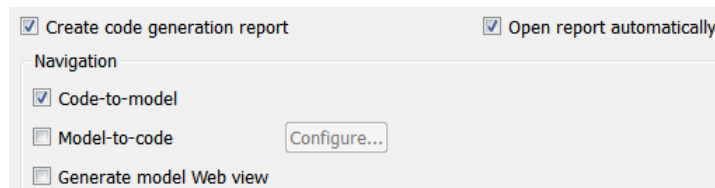

- 3 Select **Model-to-code**.

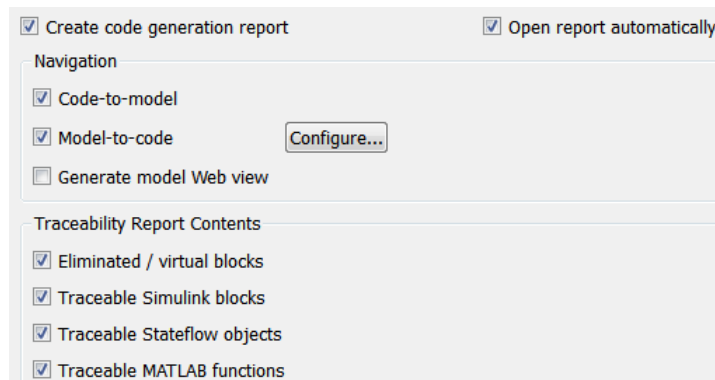

This parameter:

- Enables the **Configure** button, which opens a dialog box for loading existing trace information.
- Enables and selects parameters for customizing the content of a traceability report.

- 4 Build or generate code for the model. An HTML code generation report is displayed.
- 5 In the model window, right-click a model object.
- 6 In the context menu, select **C/C++ Code > Navigate to C/C++ Code**. In the HTML code generation report, you see the first instance of highlighted code generated for the model object. In the left pane of the report, numbers that appear to the right of generated file names indicate the total number of highlighted lines in each file. The following figure shows the result of tracing the Unit Delay block in model `rtwdemo_hyperlinks`.

```

130  /* Model step function */
131  void rtwdemo_hyperlinks_step(void)
132  {
133      static real_T tmp[5] = { 10.0, -20.0, 30.0, -40.0, 50.0 };
134
135      /* Sum: '<Root>/Sum' incorporates:
136       * Constant: '<Root>/INC'
137       * Switch: '<Root>/Switch'
138       * UnitDelay: '<Root>/X'
139       * Update for UnitDelay: '<Root>/X'
140       */
141      rtDWork.X += 2.0;
142
143      /* Stateflow: '<Root>/Chart' incorporates:
144       * Constant: '<Root>/Constant'
145       * Switch: '<Root>/Switch'
146       * Update for UnitDelay: '<Root>/X'
147       */

```

To navigate through multiple instances of highlighted lines, click **Previous** and **Next**.

If you close and reopen a model, the **Navigate to Code** context menu option might not be available. This occurs because Embedded Coder cannot find a build folder for your model in the current working folder. To address this, do one of the following:

- Reset the current working folder to the parent folder of the existing build folder.
- Select **Model-to-code** and rebuild the model. This regenerates the build folder into the current working folder.
- Click **Configure** and in the Model-to-code navigation dialog box, reload the existing trace information.

Reload Existing Traceability Information

To reload existing traceability information for a model:

- 1 In the Configuration Parameters dialog box, click **Code Generation > Report > Configure**. The Model-to-code navigation dialog box opens.

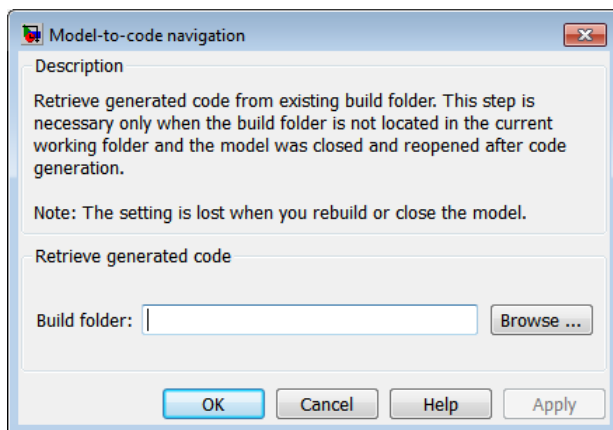

- 2 In the **Build folder** field, type or browse to the build folder that contains the existing traceability information.

If you close and reopen a model, the **Navigate to Code** context menu option might not be available. This occurs because Embedded Coder cannot find a build folder for your model in the current working folder. To fix this without having to reset the current working folder or rebuild the model, do the following:

- 1 Click **Configure** to open the Model-to-code navigation dialog box.
- 2 In the Model-to-code navigation dialog box, click **Browse**.
- 3 Browse to the build folder for your model, and select the folder. The build folder path is displayed in the **Build folder** field, as shown in the preceding figure.

- 4** Click **Apply** or **OK**. This loads traceability information from the earlier build into your Simulink session, provided that you selected **Model-to-code** for the build.
- 5** Right-click a model object and select **C/C++ Code > Navigate to C/C++ Code** to open the context menu and trace a model object to corresponding code.

Customize Traceability Reports

In the Configuration Parameters dialog box, the **Code Generation > Report > Traceability Report Contents** section lists parameters you can select and clear to customize the content of your traceability reports. By default, all parameters are selected.

Select or clear any combination of the following:

- **Eliminated / virtual blocks** (account for blocks that are untraceable)
- **Traceable Simulink blocks**
- **Traceable Stateflow objects**
- **Traceable MATLAB functions**

If you select all parameters, you get a complete mapping between model elements and the generated code.

The following figure shows the top section of the traceability report generated by selecting all traceability content parameters for model `rtwdemo_hyperlinks`.

Traceability Report for rtwdemo_hyperlinks

Generate
Traceability Matrix

Table of Contents

1. [Eliminated / Virtual Blocks](#)
2. [Traceable Simulink Blocks / Stateflow Objects / MATLAB Functions](#)
 - o [rtwdemo_hyperlinks](#)
 - o [rtwdemo_hyperlinks/Chart](#)
 - o [rtwdemo_hyperlinks/Chart:43](#)

Eliminated / Virtual Blocks

Block Name	Comment
<Root>/Build ERT	Empty SubSystem
<Root>/Mux	Mux
<Root>/Scope	Unused code path elimination
<Root>/View Code Generation Report	Empty SubSystem

Traceable Simulink Blocks / Stateflow Objects / MATLAB Functions

Root system: [rtwdemo_hyperlinks](#)

Object Name	Code Location
<Root>/Chart	rtwdemo_hyperlinks.c:20, 43, 85, 103, 112, 143, 257 rtwdemo_hyperlinks.h:39, 40, 41, 43, 45, 46, 47, 48, 49, 52, 53
<Root>/Constant	rtwdemo_hyperlinks.c:144

Generate a Traceability Matrix

If you are licensed for either DO Qualification Kit software or IEC Certification Kit software and are using a Windows host, you can generate a traceability matrix into Microsoft Excel format directly from the traceability report described in “Customize Traceability Reports” on page 28-10.

To do this, go to the **Traceability Report** section of the HTML code generation report and click the **Generate Traceability Matrix** button.

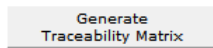

When you click the button, a Generate Traceability Matrix dialog box appears. Use this dialog to select an existing matrix file to update or specify a new matrix file to create. Optionally, you can use this dialog to select and order the columns that appear in the generated matrix. For more information, see “Generating a Traceability Matrix” in either the DO Qualification Kit documentation or the IEC Certification Kit documentation.

Traceability Limitations

The following limitations apply to reports generated by Embedded Coder software.

- Under the following conditions, model-to-code traceability is disabled for a block if the block name contains:
 - A single quote (').
 - An asterisk (*), that causes a name-mangling ambiguity relative to other names in the model. This name-mangling ambiguity occurs if in a block name or at the end of a block name, an asterisk precedes or follows a slash (/).
 - The character `(char(255))`.
- If a block name contains a newline character (`\n`), in the generated code comments, the block path name hyperlink replaces the newline character with a space for readability.
- You cannot trace blocks representing the following types of subsystems to generated code:
 - Virtual subsystems
 - Masked subsystems
 - Nonvirtual subsystems for which code has been optimized away

If you cannot trace a subsystem at subsystem level, you might be able to trace individual blocks within the subsystem.

Component Verification

- “Component Verification in the Target Environment” on page 29-2
- “Goals of Component Verification” on page 29-3
- “Maximizing Code Portability and Configurability” on page 29-4
- “Simplifying Code Integration and Maximizing Code Efficiency” on page 29-5
- “Running Component Tests” on page 29-7

Component Verification in the Target Environment

After you generate production code for a component design, you need to integrate, compile, link, and deploy the code as a complete application on the embedded system. One approach is to manually integrate the code into an existing software framework that consists of an operating system, device drivers, and support utilities. The algorithm can include externally written legacy or custom code.

An easier and more recommended approach to verifying a component in a target environment, is to use processor-in-the-loop (PIL) simulation. For information about PIL simulations, see “About SIL and PIL Simulations” on page 31-2.

Goals of Component Verification

Assuming that you have generated production source code and integrated required externally written code, such as drivers and a scheduler, you can verify that the integrated software operates as expected by testing it in the target environment. During testing, you can achieve either of the following goals, depending on whether you export code that is strictly ANSI C/C++ or mixes ANSI C/C++ with code optimized for a target environment.

Goal	Type of Code Export
Maximize code portability and configurability	ANSI C/C++
Simplify integration and maximize use of processor resources and code efficiency	Mixed code

Regardless of your goal, you must integrate required external drivers and scheduling software. To achieve real-time execution, you must integrate the real-time scheduling software.

Maximizing Code Portability and Configurability

To maximize code portability and configurability, limit the application code to ANSI/ISO C or C++ code only, as the following figure shows.

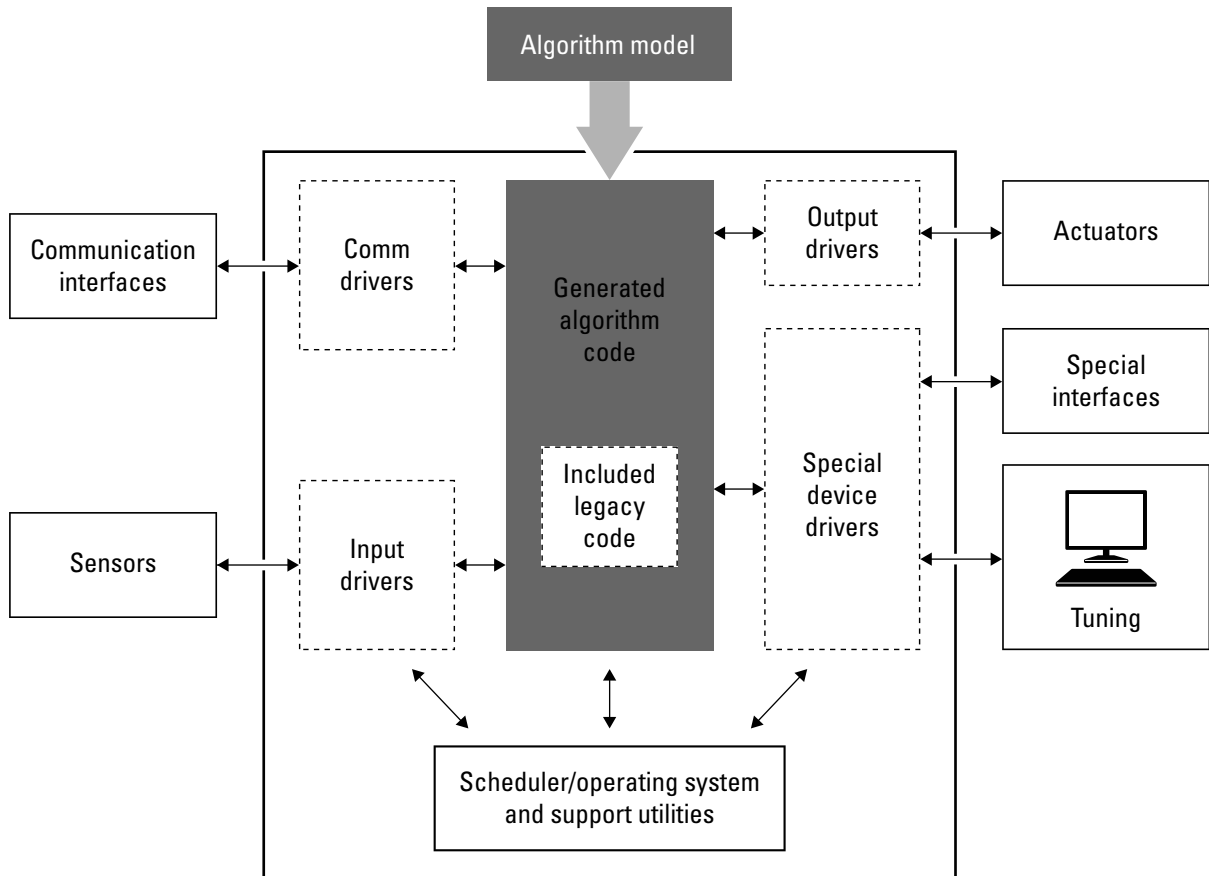

Simplifying Code Integration and Maximizing Code Efficiency

To simplify code integration and maximize code efficiency for a target environment, use Embedded Coder features for:

- Controlling code interfaces
- Exporting subsystems
- Including target-specific code, including compiler optimizations

The following figure shows a mix of ANSI C/C++ code with code that is optimized for a target environment.

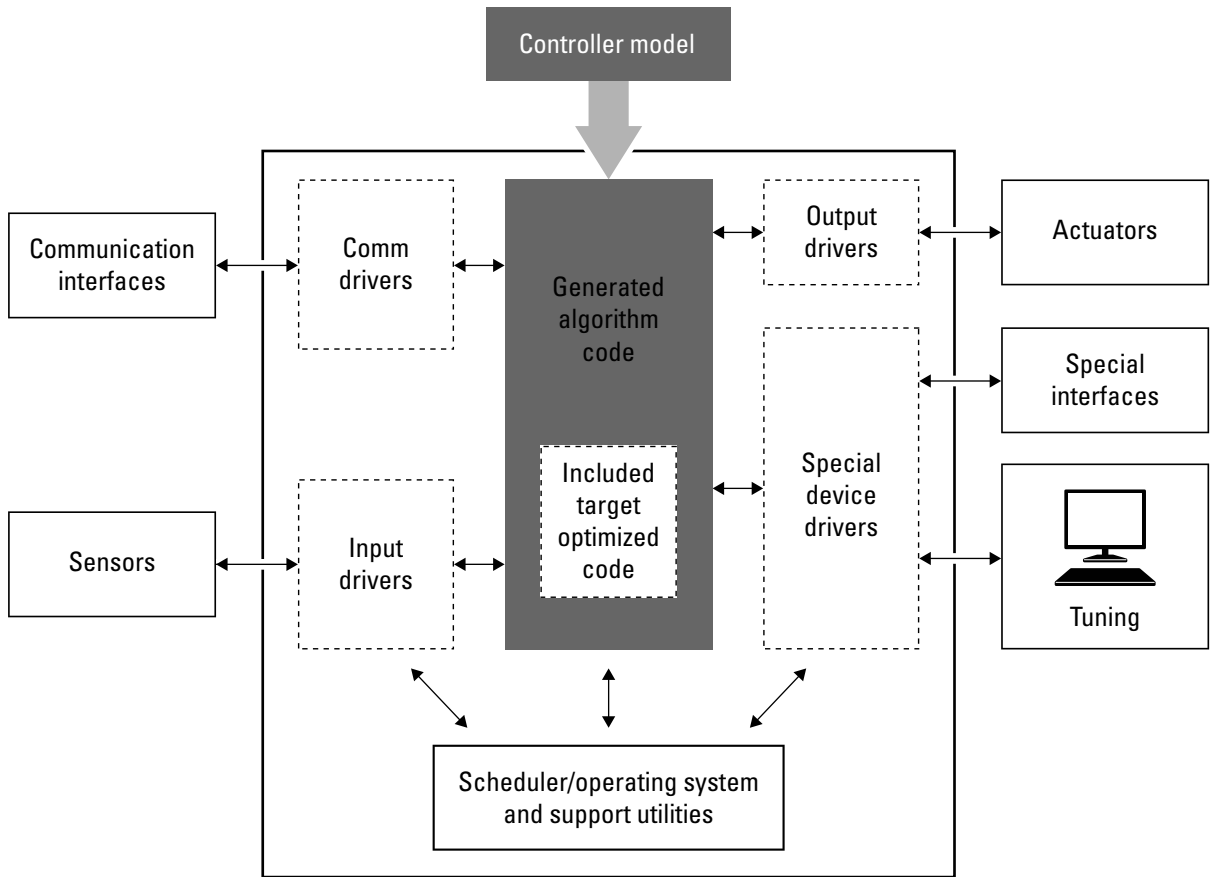

Running Component Tests

The workflow for running software component tests in the target environment is:

- 1 Integrate external code, for example, for device drivers and a scheduler, with the generated C or C++ code for your component model. For more information, see “Generate S-Function Wrappers” on page 21-2 and “Insert S-Function Code” in the Simulink Coder documentation. For more specific references depending on your verification goals, see the following table.

For...	See...
ANSI C/C++ code integration	“Integrate C Functions Using Legacy Code Tool” in the Simulink documentation. Also, open <code>rtwdemos</code> and navigate to the Custom Code folder.
Mixed code integration	<ul style="list-style-type: none"> • “Export Function-Call Subsystems” on page 22-2 and example <code>rtwdemo_export_functions</code> • “Function Prototype Control” on page 12-2, “C++ Encapsulation Interface Control” on page 12-24, and example <code>rtwdemo_fcnprotoctrl</code> • “Introduction to Code Replacement Libraries” on page 23-2 and example <code>rtwdemo_crl_script</code>

- 2 Simulate the integrated component model.
- 3 Generate code for the integrated component model.
- 4 Connect to data interfaces for the generated C code data structures. See “Data Interchange Using the C API” and “ASAP2 Data Measurement and Calibration” in the Simulink Coder documentation. Also see examples `rtwdemo_capi` and `rtwdemo_asap2`.

- 5 Customize and control the build process, if required. See “Customize Post-Code-Generation Build Processing” in the Simulink Coder documentation, and example `rtwdemo_buildinfo`.
- 6 Create a zip file that contains generated code files, static files, and dependent data to build the generated code in an environment other than your host computer. See “Relocate Code to Another Development Environment”, in the Simulink Coder documentation, and example `rtwdemo_buildinfo`.

Component Verification With a Real-Time Target Environment

- “About Real-Time Software Component Verification” on page 30-2
- “Real-Time Software Component Testing” on page 30-4

About Real-Time Software Component Verification

One approach to verifying a software component is to build the component into a complete software system that can execute in real time in the target environment. A complete software system includes:

- Algorithm for the software component
- Scheduling algorithms
- Calls to drivers for board-specific devices

This single build approach is more time consuming to set up, but makes it easier to get the complete application running in the target environment.

The following figure shows code generated for an algorithm being built into a complete system executable for the target environment.

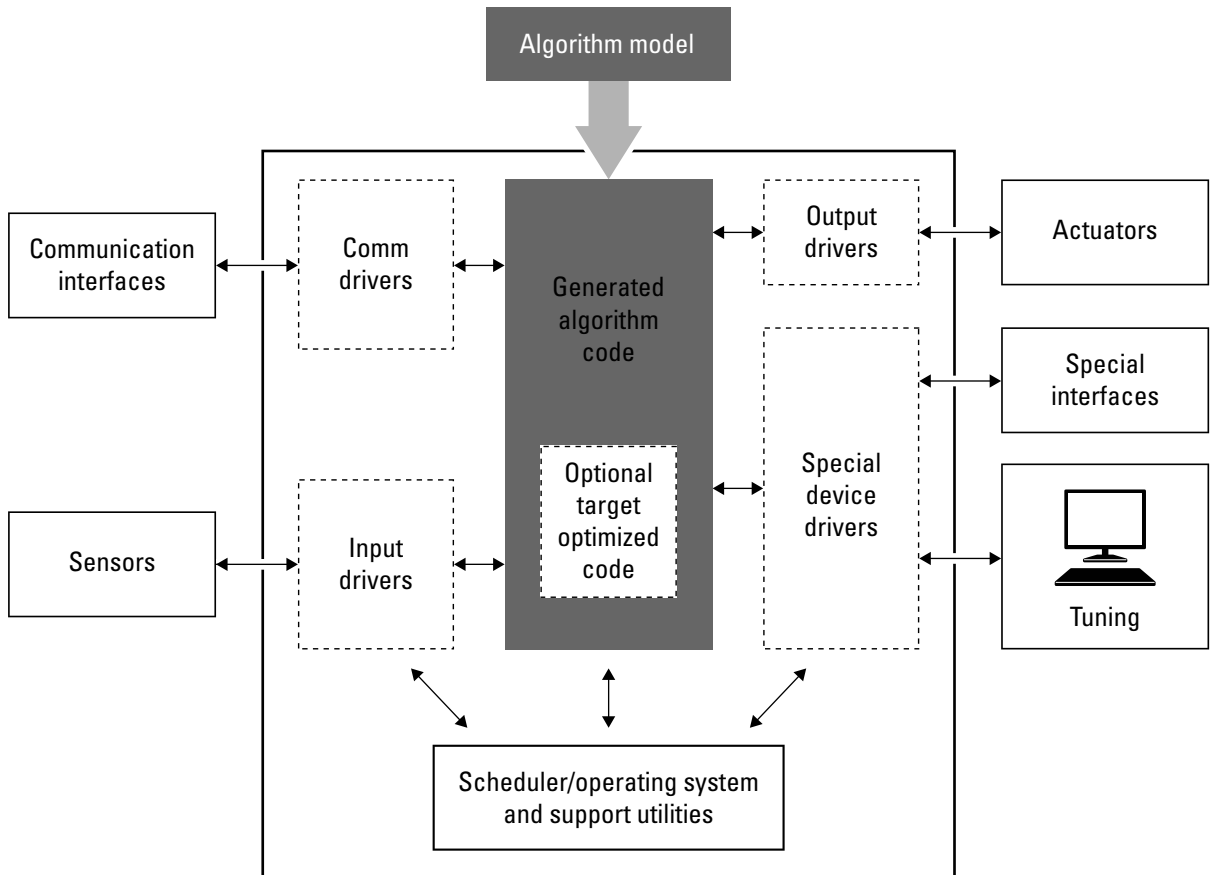

Real-Time Software Component Testing

The workflow for testing component software as part of a complete real-time target environment is:

- 1 Develop a component model and generate source code for production.

For information on building in scheduling and real-time system support, see:

- “Scheduling” in the Simulink Coder documentation. For an example, open `rtwdemos` and navigate to the **Multirate Support** folder.
- “Handle Asynchronous Events” in the Simulink Coder documentation and example `rtwdemo_async`
- “Standalone Programs (No Operating System)” on page 20-2
- “Workflows for AUTOSAR” on page 17-31 and examples `rtwdemo_autosar_legacy_script`, `rtwdemo_autosar_multirunnables_script`, and `rtwdemo_autosar_clientserver_script`

- 2 Optimize generated code for a specific run-time environment, using specialized function libraries. For more information, see “Introduction to Code Replacement Libraries” on page 23-2 and example `rtwdemo_tfl_script`.
- 3 Customize post code generation build processing to accommodate third-party tools and processes, as required. See “Customize Post-Code-Generation Build Processing” in the Simulink Coder documentation and example `rtwdemo_buildinfo`.
- 4 Integrate external code, for example, for device drivers and a scheduler, with the generated C or C++ code for your component model. For more information, see “Insert S-Function Code” in the Simulink Coder documentation. For more specific references depending on your verification goals, see the following table.

For...	See...
ANSI C/C++ code integration	“Integrate C Functions Using Legacy Code Tool” in the Simulink documentation. Also, open <code>rtwdemos</code> and navigate to the Custom Code folder.
Mixed code integration	<ul style="list-style-type: none"> • “Export Function-Call Subsystems” on page 22-2 and example <code>rtwdemo_export_functions</code> • “Function Prototype Control” on page 12-2, “C++ Encapsulation Interface Control” on page 12-24, and example <code>rtwdemo_fcnprotoctrl</code> • “Introduction to Code Replacement Libraries” on page 23-2 and example <code>rtwdemo_crl_script</code>

- 5 Simulate the integrated model.
- 6 Generate code for the integrated model.
- 7 Connect to data interfaces for the generated C code data structures. See “Data Interchange Using the C API” and “ASAP2 Data Measurement and Calibration” in the Simulink Coder documentation. Also see examples `rtwdemo_capi` and `rtwdemo_asap2`.
- 8 Customize and control the build process, as required. See “Customize Post-Code-Generation Build Processing”, in the Simulink Coder documentation, and example `rtwdemo_buildinfo`.
- 9 Create a zip file that contains generated code files, static files, and dependent data to build the generated code in an environment other than your host computer. See “Relocate Code to Another Development Environment”, in the Simulink Coder documentation, and example `rtwdemo_buildinfo`.

Numerical Equivalence Checking

- “About SIL and PIL Simulations” on page 31-2
- “How SIL and PIL Simulations Work” on page 31-6
- “Comparison of SIL and PIL Simulation” on page 31-7
- “Choose a SIL or PIL Approach” on page 31-9
- “Configure a SIL or PIL Simulation” on page 31-15
- “Top Model Simulation Using SIL or PIL” on page 31-23
- “Referenced Model Simulation Using SIL or PIL” on page 31-24
- “Code Interfaces for SIL and PIL” on page 31-28
- “Configure Hardware Implementation Settings for SIL” on page 31-30
- “Debugging During SIL Simulations” on page 31-36
- “Programming PIL Support Using Third-Party Tools” on page 31-39
- “Create a Connectivity Configuration for a Target” on page 31-40
- “View Test Harness in Code Generation Report” on page 31-53
- “SIL and PIL Simulation Support and Limitations” on page 31-55
- “Programmatic Code Generation Verification” on page 31-85

About SIL and PIL Simulations

In this section...
“Overview” on page 31-2
“What are SIL and PIL Simulations?” on page 31-2
“Why Use SIL and PIL” on page 31-3

Overview

Embedded Coder supports *software-in-the-loop* (SIL) and *processor-in-the-loop* (PIL) simulations, which allow you to verify generated source code and compiled object code.

A SIL simulation involves compiling and running production source code on your host computer, while a PIL simulation involves cross-compiling and running production object code on a target processor or an equivalent instruction set simulator.

You can use SIL and PIL simulations to verify the numerical behavior of your code, optimize your code, collect code metrics such as code coverage and execution profiling data, and achieve IEC 61508, ISO 26262, or DO-178 certification. See “Why Use SIL and PIL” on page 31-3.

For examples of SIL and PIL verification, see `rtwdemo_sil_pil_script`. For information about how you verify the configuration of your model for a SIL or PIL simulation, see “Verify a SIL or PIL Configuration” on page 31-20.

What are SIL and PIL Simulations?

The Embedded Coder product supports software-in-the-loop (SIL) and processor-in-the-loop (PIL) simulations.

A SIL simulation involves compiling and running production source code on your host computer to verify the source code. SIL provides a convenient alternative to processor-in-the-loop (PIL) simulation as no target hardware (for example, an evaluation board or instruction set simulator) is required. For examples of SIL verification, see `rtwdemo_sil_pil_script`.

A PIL simulation involves cross-compiling and running production object code on a target processor or an equivalent instruction set simulator.

You can run a SIL or PIL simulation using:

- The **Software-in-the-Loop (SIL)** or **Processor-in-the-Loop (PIL)** simulation mode for top models and Model blocks
- A SIL or PIL block

For more information, see “Choose a SIL or PIL Approach” on page 31-9.

The following features enable you to verify the generated code:

- Compare the output of regular simulation modes, for example, Normal or Accelerator, against the output of SIL and PIL simulation modes.
- Easily switch between regular simulation, SIL, and PIL modes.

You can model and test your embedded software component in Simulink and then reuse your test suites across simulation and compiled production code. This approach avoids the time-consuming process of leaving the Simulink software environment and verifying production code on a separate test infrastructure.

Why Use SIL and PIL

You can achieve early verification and fixing of defects when you use SIL and PIL. See “V-Model for System Development” in the Simulink Coder documentation.

The following table describes situations when you should use SIL and PIL.

Situation	Use...
<p>You want to reuse test vectors developed for Normal mode simulation to verify numerical output of generated (or legacy) code. For example, reusing test cases generated by Simulink Design Verifier™. See “What Is Test Case Generation?” in the Simulink Design Verifier documentation.</p>	SIL and PIL
<p>You want to collect metrics for generated code:</p> <ul style="list-style-type: none"> • Code coverage. See “Code Coverage in SIL and PIL Simulations” on page 32-2. • Execution profiling. See “About Code Execution Profiling” on page 33-2 • Stack profiling. See “Stack Profiling for Embedded Targets” on page 36-28. 	SIL and PIL
<p>You want to achieve IEC 61508, ISO 26262, and DO-178 certification. See “Verification and Validation at the Code Level (Code Verification)” in the IEC Certification Kit documentation and Testing of Outputs of Integration Process in the DO Qualification Kit documentation.</p>	SIL and PIL
<p>You do not have target hardware and want a convenient alternative to PIL.</p>	SIL
<p>You have target hardware, for example, an evaluation board or instruction set simulator, and you want to:</p> <ul style="list-style-type: none"> • Verify behavior of target specific code, for example, Code Replacement optimizations, and legacy code. See “Introduction to Code Replacement Libraries” on page 23-2. • Optimize the execution speed and memory footprint of your code. See, in this table, row with information about collecting execution profiling and stack profiling metrics. • Investigate effects of compiler settings and optimizations, for example, deviation from ANSI C overflow behavior. 	PIL

Situation	Use...
<p>Normal simulation techniques do not account for restrictions and requirements that the hardware imposes, such as limited memory resources or behavior of target-specific optimized code.</p> <p>See “Sample Custom Targets” in the Simulink Coder documentation, which gives information about running PIL simulations on specific targets.</p>	

How SIL and PIL Simulations Work

In a SIL/PIL simulation, code is generated for either the top model or part of the model. With SIL, this code is compiled for, and executed on the host computer. With PIL, the code is cross-compiled for the target hardware and runs on the target processor.

Through a communication channel, Simulink sends stimulus signals to the code on the host or target processor for each sample interval of the simulation:

- For a top model, Simulink uses stimulus signals from the base or model workspace.
- If you have designated only part of the model to simulate in SIL/PIL mode, then a part of the model remains in Simulink without the use of code generation. Typically, you configure this part of the model to provide test vectors for the software executing on the hardware. This part of the model can represent other parts of the algorithm or the environment model in which the algorithm operates.

When the host/target processor receives signals from Simulink, the processor executes the SIL/PIL algorithm for one sample step. The SIL/PIL algorithm returns output signals computed during this step to Simulink through a communication channel. At this point, one sample cycle of the simulation is complete and Simulink proceeds to the next sample interval. The process repeats and the simulation progresses. SIL/PIL simulations do not run in real time. At each sample period, Simulink and the object code exchange I/O data. See also “Verify Internal Signals of a Component” on page 31-24.

Comparison of SIL and PIL Simulation

Use SIL or PIL simulation to verify automatically generated code by comparing the results with a Normal mode simulation. With SIL, you can easily verify the behavior of production source code on your host computer. However, you cannot verify exactly the same code that is subsequently compiled for your target hardware because the code must be compiled for your host computer (that is, a different compiler and different processor architecture than the target). With PIL simulation, you can verify exactly the same code that you intend to deploy in production, and you can run the code on either real target hardware or an instruction set simulator. See “What are SIL and PIL Simulations?” on page 31-2.

You can use the following approaches to verification.

Approach	SIL	PIL
Simulation mode (for top model or Model block)	Generated production code compiled and executed on host computer as separate process, independent of the MATLAB process. Execution is host/host and nonreal time	Test the generated code as cross-compiled object code on target processor or instruction set simulator. Exercises same object code used in production software. Execution is host/target and nonreal time.
Block	Create SIL block. Software runs generated code through S-function wrapper on host computer. SIL S-function links directly with generated code, so generated code runs inside MATLAB process. Execution is host/host and nonreal time. See “Use a SIL or PIL Block” on page 31-19.	Create PIL block. Software runs cross-compiled object code through S-function wrapper on host computer. S-function communicates with object code executing as standalone application on target processor or instruction set simulator. Execution is host/target and nonreal time. See “Use a SIL or PIL Block” on page 31-19.

To decide which verification approach you want to use, see “Choose a SIL or PIL Approach” on page 31-9 .

Choose a SIL or PIL Approach

In this section...
“About Choosing a SIL or PIL Simulation” on page 31-9
“When to Use Top-Model SIL or PIL” on page 31-9
“When to Use Model Block SIL or PIL” on page 31-9
“When to Use the SIL or PIL Block” on page 31-13

About Choosing a SIL or PIL Simulation

This section describes how to choose the SIL or PIL verification approach for your needs.

For examples, see `rtwdemo_sil_pil_script`, which allow you to compare:

- SIL block for SIL Simulation
- SIL or PIL Simulation for Model Blocks
- SIL or PIL Simulation for Top Models

When to Use Top-Model SIL or PIL

Use the top-model approach if you want to:

- Verify code generated for a top model (standalone code interface).
- Load test vectors or stimulus inputs from the MATLAB workspace.
- Switch the entire model between normal, SIL, or PIL simulation modes.

For an example, see `rtwdemo_sil_pil_script`.

When to Use Model Block SIL or PIL

Use the Model block approach if you want to:

- Verify code generated for referenced models (model reference code interface).

- Provide a test harness model (or a system model) to generate test vector or stimulus inputs.
- Switch a Model block between normal, SIL, or PIL simulation modes.

See “Modeling Scenarios with the Model Block” on page 31-10.

Modeling Scenarios with the Model Block

You can use the Model block to test single components or a whole hierarchy of model reference components. For example, you can select a single leaf component for SIL verification. Later in the development cycle, as your components become integrated into a larger system, you can select a hierarchy of components for SIL verification.

You must deploy your Model block component code as part of a standalone executable. The following examples show ways of testing your component.

- “Testing a Model Reference Component in SIL Mode” on page 31-10
- “Deploying Through an Atomic Subsystem” on page 31-11
- “Deploying Through a Top Model” on page 31-12

Testing a Model Reference Component in SIL Mode. You can test a model reference component or hierarchy of components by placing a Model block in a test harness model, as shown in model T1.

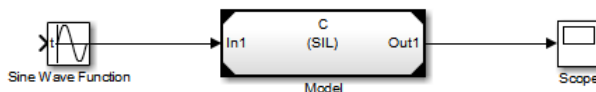

To test the component, for example, in SIL mode:

- 1 Set the simulation mode of component C to SIL mode.
- 2 Simulate the model to run component C in SIL mode, and test its model reference target.

Note If the model reference target code interface for component C does not already exist, simulating the model generates it. For more information about the model reference target code interface, see “Code Interfaces for SIL and PIL” on page 31-28.

The following deployment scenarios reuse the model reference target of component C. This reuse allows you to test exactly the same object code that you deploy.

Deploying Through an Atomic Subsystem. To generate code with the standalone interface for deployment, place a Model block inside an atomic subsystem, as shown by model D1

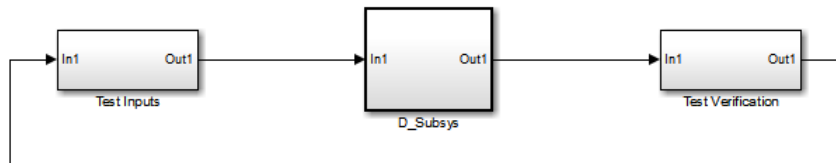

and D_Subsys

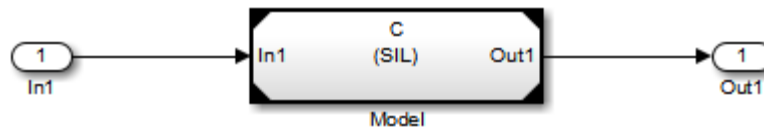

To create standalone code, perform a subsystem build of D_Subsys. The standalone code calls the model reference target of component C.

To test the component, for example, in SIL mode:

- 1 Set the simulation mode of component C to SIL mode.
- 2 Simulate the model to run component C in SIL mode and test its model reference target.

You can place multiple Model blocks and other blocks into the model to deploy a whole system of components.

Deploying Through a Top Model. To generate code with the standalone interface for deployment, place the Model block inside a top model, as shown by model D2.

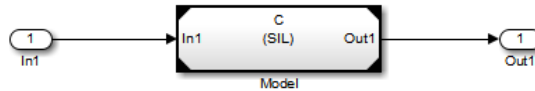

To create standalone code, perform a build of D2. The standalone code calls the model reference target of component C.

You can place multiple Model blocks and other blocks into the model to deploy a whole system of components.

To pass test inputs to component C (running in SIL mode):

- 1 Create a test harness model that references model D2 in Normal mode, as shown by model T2.

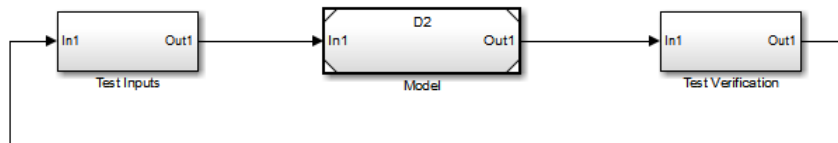

- 2 Simulate the T2 model to run component C in SIL mode and test its model reference target.

The Model Dependency Viewer shows the model reference hierarchy of T2 and the simulation modes of each Model block component.

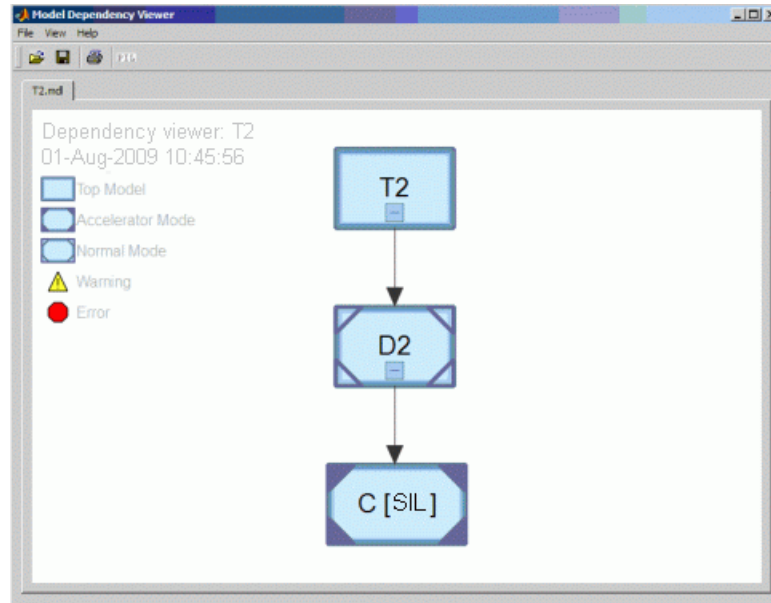

When to Use the SIL or PIL Block

Use the SIL or PIL block if you want to:

- Verify code generated for a top model with a standalone code interface, or a subsystem with a (right-click build) standalone code interface. For more information about the standalone target code interface, see “Code Interfaces for SIL and PIL” on page 31-28.
- Change the model and insert a SIL or PIL block to represent a component running in SIL or PIL mode, in a situation where a test harness model or a system model provides test vector or stimulus inputs.

For example, you can replace the controller subsystem in the following model,

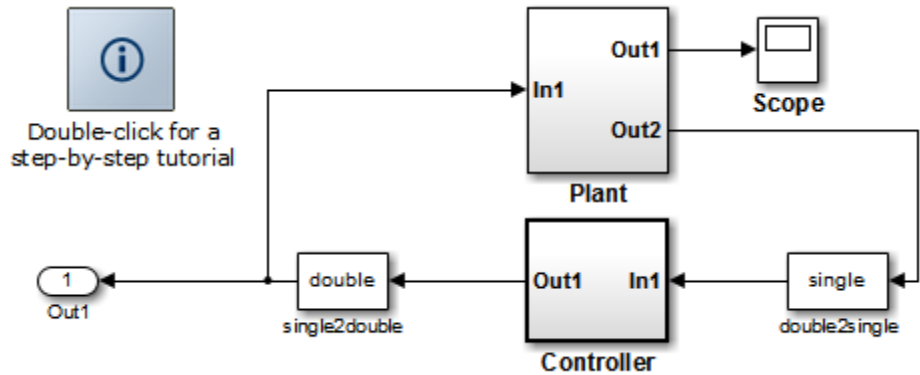

with a SIL block (highlighted) that represents the controller.

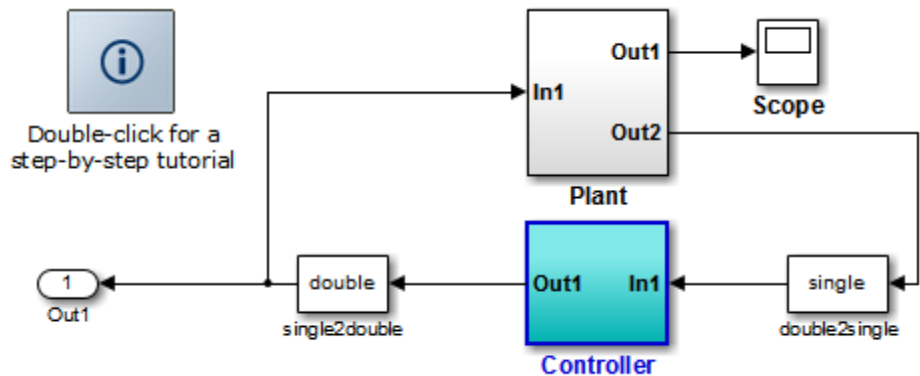

For information about how you create a SIL or PIL block, see “Use a SIL or PIL Block” on page 31-19.

Note If you compare a SIL or PIL block simulation with a top-model simulation, you see that you must perform two steps before you can run the simulation. First, you perform a right-click subsystem build to create the SIL or PIL block. Then, you replace the subsystem in the original model with the newly created SIL block.

Configure a SIL or PIL Simulation

In this section...

“Top-Model SIL or PIL Simulation” on page 31-15

“Model Block SIL or PIL Simulation” on page 31-17

“Use a SIL or PIL Block” on page 31-19

“Verify a SIL or PIL Configuration” on page 31-20

Top-Model SIL or PIL Simulation

To configure and run a top-model SIL or PIL simulation:

- 1 Open your model.
- 2 Select either **Simulation > Software-in-the-Loop (SIL)** or **Simulation > Processor-in-the-Loop (PIL)**.

Note This option is available only if the model is configured for an ERT or AUTOSAR target. See “Code Generation Pane: General” and “Generate AUTOSAR Code and Description Files” on page 17-82 for configuration information.

- 3 If you have not already done so, in the Configuration Parameters dialog box, on the **Data Import/Export** pane:
 - In the **Input** check box and field, specify stimulus signals (or test vectors) for your top model.
 - Configure logging for model outputs, using either *output logging* or *signal logging*:
 - In the **Output** check box and field, specify *output logging*.
 - In the **Signal logging** check box and field, specify *signal logging*. See “Internal Signal Logging Support” on page 31-66 and “Top-Model Root-Level Logging Limitations” on page 31-67.

- Disable logging of Data Store Memory variables. The software does not support this option for this simulation mode. If you do not clear the **Data stores** check box, the software produces a warning when you run the simulation.
- 4** If you are configuring a SIL simulation, specify the portable word sizes option. This option allows you to switch seamlessly between the SIL and PIL modes. Select **Code Generation > Verification > Enable portable word sizes**. See “Configure Hardware Implementation Settings for SIL” on page 31-30.
 - 5** If required, configure:
 - Code coverage. See “Code Coverage in SIL and PIL Simulations” on page 32-2.
 - Code execution profiling. See “Configure Code Execution Profiling” on page 33-3.
 - Creation of code generation report and static code metrics. See “View Test Harness in Code Generation Report” on page 31-53.
 - 6** Start the simulation.

Note You cannot:

- Close the model while the simulation is running. To interrupt the simulation, in the Command Window, press **Ctrl+C**.
 - Alter the model during the simulation. You can move blocks and lines as long as it does not alter the behavior of the model.
-

You can run a top-model SIL or PIL simulation using the command `sim(model)`.

Note The software supports the `sim` command options `SrcWorkspace` and `DstWorkspace` for only the following values:

- `SrcWorkspace` — 'base'
- `DstWorkspace` — 'base' or 'current'

For more information on the `sim` command and its options, see “Run Simulation Using the `sim` Command” in the Simulink documentation.

For information about how a simulation behaves when the top model contains a Model block (and this Model block is a parent Model block containing Model blocks at lower levels of its reference hierarchy), see “Simulation Mode Override Behavior in Model Reference Hierarchy” on page 31-25.

For a PIL simulation, you control the way code compiles and executes in the target environment through connectivity configurations. See “Create a Connectivity Configuration for a Target” on page 31-40.

Model Block SIL or PIL Simulation

To configure a Model block for a SIL or PIL simulation:

- 1 Open your model.

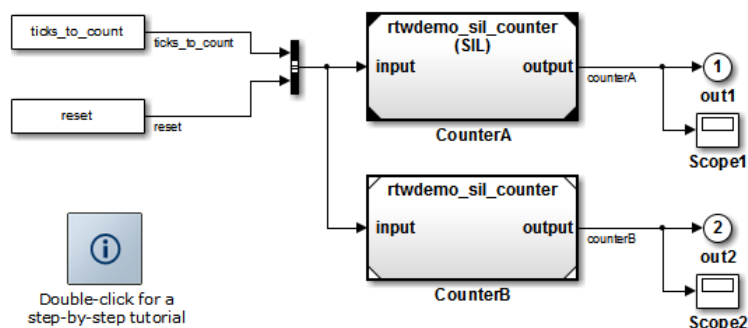

- 2 Right-click your Model block, for example, Counter A. In the context menu, select **ModelReference Parameters** to open the Model Reference Parameters dialog box.
- 3 From the **Simulation Mode** drop-down list, select the required mode, for example, Software-in-the-loop (SIL).

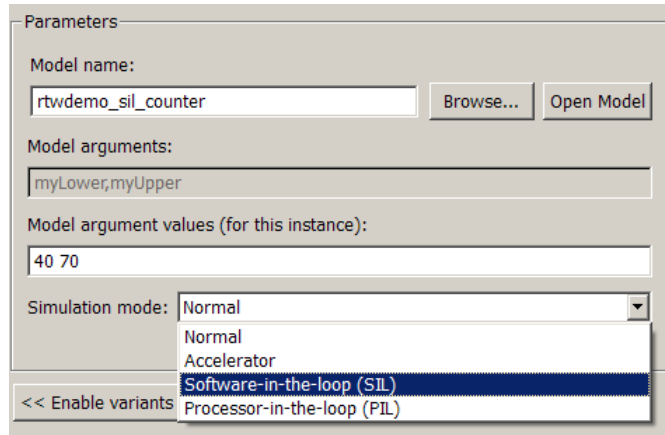

- 4 If you are configuring a SIL simulation, specify the portable word sizes option. This option allows you to switch seamlessly between the SIL and PIL modes. Select **Code Generation > Verification > Enable portable word sizes**. See “Configure Hardware Implementation Settings for SIL” on page 31-30.
- 5 If required, configure:
 - Code coverage. See “Code Coverage in SIL and PIL Simulations” on page 32-2.
 - Code execution profiling for your Model block, by configuring execution profiling for the top model. See “Configure Code Execution Profiling” on page 33-3.
 - Creation of code generation report and static code metrics. See “View Test Harness in Code Generation Report” on page 31-53.
- 6 Start the simulation.

Note For a PIL simulation, you control the way code compiles and executes in the target environment through connectivity configurations. See “Create a Connectivity Configuration for a Target” on page 31-40.

Use a SIL or PIL Block

You can automatically create a SIL or PIL block from a complete model or a subsystem. You can use this block to test the code generated from your model:

- 1** In the Configuration Parameters dialog box, select **Code Generation > Verification**.
- 2** From the **Create block** drop-down list, select either SIL or PIL.
- 3** If you want to enable code execution profiling for a PIL block:
 - a** Select the **Collect execution time measurements** check box.
 - b** In the **Workspace variable field**, specify a name.
The software does not support code execution profiling in SIL blocks. For more information, see “About Code Execution Profiling” on page 33-2.
- 4** Click **OK**.
- 5** In your model window, right-click the subsystem that you want to simulate.
- 6** Select **C/C++ Code > Build This Subsystem**.
- 7** Click **Build** to start a subsystem build that generates a SIL or PIL block for the generated subsystem code.
- 8** Add the generated block to an environment or test harness model that supplies test vectors or stimulus input.
- 9** Run simulations with the environment or test harness model to perform SIL or PIL tests.
- 10** Verify that the generated code captured in the SIL or PIL block provides the same result as the original subsystem.

Note You cannot create a SIL or PIL block (**Create block** appears dimmed) if you do one of the following:

- Disable either the `CreateSILPILBlock` or `GenerateErtSFunction` property
 - Select a code coverage tool
-

For a PIL simulation, you control the way code compiles and executes in the target environment through connectivity configurations. See “Create a Connectivity Configuration for a Target” on page 31-40.

For an example of how the SIL block is used in testing, see `rtwdemo_sil_pil_script`.

For a description of the SIL block as an S-function wrapper, see “Generate S-Function Wrappers” on page 21-2.

Verify a SIL or PIL Configuration

You might need to change model settings to configure the model for SIL or PIL. To find out what settings you must change, use the `cgv.Config` class. Using the `cgv.Config` class, you can review your model configuration and determine which settings you must change to configure the model for SIL or PIL. By default, `cgv.Config` changes configuration parameter values to the value that it recommends, but does not save the model. Alternatively, you can specify that `cgv.Config` use one of the following approaches:

- Change configuration parameter values to the values that `cgv.Config` recommends, and save the model. Specify this approach using the `SaveModel` property.
- List the values that `cgv.Config` recommends for the configuration parameters, but do not change the configuration parameters or the model. Specify this approach using the `ReportOnly` property.

Note

- To execute the model in the target environment, you might need to make additional modifications to the configuration parameter values or the model.
 - Do not use referenced configuration sets in models that you are changing using `cgv.Config`. If the model uses a referenced configuration set, update the model with a copy of the configuration set. Use the `Simulink.ConfigSetRef.getRefConfigSet` method. For more information, see `Simulink.ConfigSetRef` in the Simulink documentation.
 - If you use `cgv.Config` on a model that executes a callback function, the callback function might change configuration parameter values each time the model loads. The callback function might revert changes that `cgv.Config` made. When this change occurs, the model might no longer be set up for SIL or PIL. For more information, see “Callbacks for Customized Model Behavior”.
-

For more information about the `cgv.Config` class, see `cgv.Config`.

How To Verify a SIL or PIL Configuration

To verify that your model is configured for SIL or PIL:

- 1 Construct a `cgv.Config` object that changes the configuration parameter values without saving the model. For example, to configure your model for SIL:

```
c = cgv.Config('vdp', 'connectivity', 'sil');
```

Tip

- You can obtain a list of changes without changing the configuration parameter values. When you construct the object, include the 'ReportOnly', 'on' property name and value pair.
 - You can change the configuration parameter values and save the model. When you construct the object, include the 'SaveModel', 'on' property name and value pair.
-

- 2 Determine and change the configuration parameter values that the object recommends using the `configModel` method. For example:

```
c.configModel();
```

- 3 Display a report of the changes that `configModel` makes. For example:

```
c.displayReport();
```

- 4 Review the changes.

- 5 To apply the changes to your model, save the model.

Top Model Simulation Using SIL or PIL

With a top-model SIL or PIL simulation:

- Simulink generates and executes code that uses the same code interface produced by the standalone build process. See “Code Interfaces for SIL and PIL” on page 31-28.
- You can load data from the MATLAB workspace to specify stimulus signals, and you can log output signals, which allows you to verify object code generated from a complete model without creating a separate test harness model. Running the SIL or PIL simulation is a simple operation.

Top-model SIL/PIL simulation is an alternative to the block-based approach. Two differences between the block-based approach and top-model SIL/PIL simulation are:

- With Model block SIL/PIL simulation, the model reference target that is generated does not have the same interface as standalone code (see “Code Interfaces for SIL and PIL” on page 31-28).
- With Model block SIL/PIL simulations, you cannot load data from the workspace but instead you must use input and output blocks to feed signals into and out of your model. See “Verify Internal Signals of a Component” on page 31-24 and “Choose a SIL or PIL Approach” on page 31-9.

To compare SIL/PIL simulation options, see “Choose a SIL or PIL Approach” on page 31-9.

For the top-model SIL/PIL approach, Simulink creates a hidden *wrapper* model. When you run a top-model SIL simulation, the software generates code for the model and creates a hidden wrapper model to call this code at each time step.

Under some circumstances this causes logged signals to have a `_wrapper` suffix. See “Top-Model Root-Level Logging Limitations” on page 31-67.

Referenced Model Simulation Using SIL or PIL

In addition to the regular simulation modes, Model blocks have a Software-in-the-loop (SIL) and Processor-in-the-loop (PIL) mode.

You can switch the Model block between regular, SIL, and PIL simulation modes. This allows you to easily verify the generated code by executing the referenced model as compiled code on the host computer or target platform. You can model and test your embedded software component in Simulink and you can reuse your regression test suites across simulation and compiled object code. This capability avoids the time-consuming process of leaving the Simulink software environment to run tests again on object code compiled for your production hardware.

The label (SIL) or (PIL) on the block indicates the mode of the Model block.

To understand how SIL or PIL works in the Model block, see the following information:

- “Simulation Mode Override Behavior in Model Reference Hierarchy” on page 31-25
- “Code Interfaces for SIL and PIL” on page 31-28
- “When to Use Model Block SIL or PIL” on page 31-9
- “Modeling Scenarios with the Model Block” on page 31-10

For an introduction to the Model block, see the Model Variants block section in the Simulink reference documentation.

Verify Internal Signals of a Component

Outputs of the SIL or PIL component are available for verification. If you want to examine an internal signal, you can:

- Enable internal signal logging for top-model or Model block SIL or PIL, but check the limitations. See “Internal Signal Logging Support” on page 31-66.
- Manually route the signal to the top level.
- Use global data stores to access internal signals:

- 1 Inside the component, connect a Data Store Write block to the required signal.
- 2 Outside the component, use a Data Store Read block to access the signal value.

See “About Data Stores” and “Global Data Store Example” in the Simulink documentation.

- Use MAT-file logging. See “Logging” in the Simulink Coder documentation. For PIL, target environment must support MAT-file logging.

For more information on signal support, see “I/O Support” on page 31-70.

Simulation Mode Override Behavior in Model Reference Hierarchy

This section describes simulation behavior when the top model contains a Model block. This Model may also be a parent block containing child Model blocks at lower levels of its reference hierarchy.

Note You can view your model hierarchy in the Model Dependency Viewer. In the Referenced Model Instances view, the software displays Model blocks differently to indicate their simulation modes, for example, Normal, Accelerator, SIL, and PIL. In this view, the software does not indicate the simulation mode of the top model.

You can specify the simulation mode of a top model to be Normal, Accelerator, Rapid Accelerator, SIL, or PIL. With a Model block, you can specify all modes *except* Rapid Accelerator. The configured simulation mode of a Model block may be overridden by the parent simulation mode. The following table shows how the software determines the effective simulation mode of a Model block in the hierarchy.

Mode of top model or parent block	Mode of parent or child block in reference hierarchy			
	Normal	Accelerator	SIL	PIL
Normal	Equivalent	Compatible	Compatible	Compatible
Accelerator	Override	Equivalent	Error	Error
Rapid Accelerator	Override	Override	Error	Error
SIL	Override	Override	Equivalent	Error
PIL	Override	Override	Error	Equivalent

The following list explains the different types of simulation behavior:

- Equivalent – Both parent and child Model block run in the same simulation mode.
- Compatible – If the simulation mode of the top model or parent block is Normal, then the software simulates the child block in the mode specified for it.
- Error – The simulation produces an error. For example, if a top model or parent Model block has simulation mode Accelerator but contains a child block in SIL or PIL mode, then running a simulation produces an error: the Accelerator mode cannot override the SIL and PIL mode of child blocks. This behavior avoids the risk of “false positives”, that is, the simulation of a model in Accelerator mode will not lead to the conclusion that generated source or object code of child Model blocks has been tested or verified.
- Override – The simulation mode of the top model or parent Model block overrides the simulation mode of the child block. For example, if a top model or parent Model block that is configured for a SIL simulation contains a child Model block with simulation mode Normal or Accelerator, then the software simulates the child block in SIL mode. This override behavior:
 - Allows a Model block in the reference hierarchy to have the SIL or PIL mode.
 - Makes lower-level referenced models execute in SIL or PIL mode if you simulate the top model or parent Model block in SIL or PIL mode, . You

do not have to switch manually the simulation mode of every model component in the hierarchy.

For an example model hierarchy, see “Modeling Scenarios with the Model Block” on page 31-10.

Code Interfaces for SIL and PIL

This section describes and compares the different code interfaces that the code generation products produce.

You generate standalone code when you perform a top-model or right-click subsystem build for a single deployable component. You can compile and link standalone code into a standalone executable or integrate it with other code. For more information on the standalone code interface, see “Entry Point Functions and Scheduling”.

When you generate code for a referenced model hierarchy, the software generates standalone executable code for the top model, and a library module called a *model reference target* for each referenced model. When the code executes, the standalone executable invokes the applicable model reference targets to compute the referenced model outputs. For more information, see “Build Model Reference Targets”.

Note The model reference target does not have the same code interface as standalone code.

If you intend to integrate automatically generated code with legacy code, use standalone code because the standalone code interface (for example, entry points) is fully documented.

SIL/PIL Feature	Standalone Code Interface	Model Reference Code Interface
Top-model	Yes	No (but you can include Model blocks inside your top model)
Model block	No	Yes
SIL or PIL block	Yes	No

Code Interface for Top-Model SIL or PIL

Top-model SIL or PIL generates the *standalone code interface* for the model.

When you run a top-model SIL or PIL simulation, the software calls the standalone code for the model if it already exists. The software generates the standalone code if it does not exist.

Code Interface for Model Block SIL or PIL

Model block SIL or PIL mode generates the *model reference* code interface.

When you run a simulation with a Model block in SIL or PIL mode, the software calls the model reference target for the Model block if it already exists, or generates the model reference target.

If the model reference target does not yet exist, you can generate it in one of three ways:

- Run the simulation.
- Press **Ctrl+B** to build the top model containing the Model block.
- Use the command `slbuild`, specifying the model reference option, for example:

```
slbuild('model', 'ModelReferenceRTWTargetOnly')
```

You cannot use standalone code with the Model block. You can generate standalone code for a model referenced by a Model block by opening the model and performing a top-level build. However, you cannot use this standalone code with Model block SIL or PIL simulation.

For more information, see the table in “Choose a SIL or PIL Approach” on page 31-9.

Configure Hardware Implementation Settings for SIL

In this section...
“Choose Hardware Implementation Options” on page 31-30
“Portable Word Sizes” on page 31-30
“Emulation Hardware” on page 31-34
“Embedded hardware configured for host” on page 31-35

Choose Hardware Implementation Options

Hardware Implementation Settings Option	Choose when...
Portable word sizes	Portable word sizes is the preferred option, because you can switch seamlessly between the SIL and PIL modes without regenerating code.
Emulation hardware	Use this option only if you need to work around a limitation of portable word sizes. You cannot use PIL mode with this option.
Embedded hardware configured for host	Use this option only if the embedded hardware settings match the host, e.g., to generate code for the host platform.

Portable Word Sizes

Embedded Coder provides an option to specify portable word sizes. If you select this option for a model, you can use the same generated source code files for:

- Software-in-the-loop (SIL) simulation on the host computer
- Production deployment on the target platform

To configure a model to use portable word sizes, set the following model configuration parameters.

Set...	To...
Hardware Implementation > Emulation hardware > None	Selected
Code Generation > Verification > Enable portable word sizes	Selected

When you generate code for a model with the preceding parameter settings, the code generator conditionalizes data type definitions:

- `tmwtypes.h` supports SIL simulation on the host system
- Code generation types support deployment on the target system

For example, in the following generated code, the first two lines define types for SIL simulation on a host system. The **bold** lines define types for target deployment.

```

#ifdef PORTABLE_WORDSIZES      /* PORTABLE_WORDSIZES defined */
# include "tmwtypes.h"
#else                          /* PORTABLE_WORDSIZES not defined */
#define __TMWTYPES__
#include <limits.h>
...
typedef signed char int8_T;
typedef unsigned char uint8_T;
typedef int int16_T;
typedef unsigned int uint16_T;
typedef long int32_T;
typedef unsigned long uint32_T;
typedef float real32_T;
typedef double real64_T;
...
#endif                          /* PORTABLE_WORDSIZES */

```

Compile Generated Code That Supports Portable Word Sizes

When you compile generated code that supports portable word sizes for SIL testing, pass the definition `PORTABLE_WORDSIZES` to the compiler.

For example:

```
-DPORTABLE_WORDSIZES
```

To build the same code for target deployment, compile the code without the `PORTABLE_WORDSIZES` definition.

Code that the Host Cannot Compile

Consider the case where your target uses code that the host cannot compile. When you switch from the PIL mode to the SIL mode and try to simulate the model, you see compilation errors. You might be able to work around this problem by adding the source code files to the `SkipForSil` group in the build information object `RTW.BuildInfo`. The SIL build on the host platform does not compile source files present in the `SkipForSil` group. For information about how you add source code files to a group in the build information object, see:

- `addSourceFiles` in the Simulink Coder reference documentation
- “Customize Post-Code-Generation Build Processing” in the Simulink Coder documentation

Portable Word Sizes Limitations

The following limitations apply when using portable word sizes in SIL simulation:

- Numerical results might differ between generated code executing in a SIL simulation and generated code executing on the embedded hardware under one of the following conditions:
 - Your model contains blocks implemented in TLC, for which C integral promotion in expressions might behave differently between the MATLAB host and the embedded hardware target. Normal and PIL simulation results will match, but SIL simulation results might be different.

- Your embedded hardware implements rounding to Floor for signed integer division, and divisions in your model use rounding mode Floor or Simplest. Normal and PIL simulation results will match, but SIL simulation results might be different.
- The precision of floating-point operations differs between the MATLAB host and the embedded hardware target. In this case, Normal and SIL simulation results will match, but PIL simulation results might be different.
- You use custom code with the Stateflow product. In this case, type conversion statements will not be inserted into the custom code, which may be required to achieve target overflow behavior on the host. Normal and PIL simulation results will match, but SIL simulation results might be different.
- Compilation warnings might occur for code generated using portable word sizes if all of the following conditions exist:
 - The combination of MATLAB host and embedded hardware target word sizes causes `rtwtypes.h` to redefine the word sizes using preprocessor macros. For example, when the embedded hardware has a 16-bit `int` data type and the MATLAB host has a 16-bit `short` data type, `int16_T` is redefined to be `short` on the host and `int` on the target.
 - The data types are used in pointer arguments to function calls.
 - The called functions are host-based precompiled functions (not compiled using `rtwtypes.h`).

Under these conditions, the compiler typically issues a warning similar to the following:

```
warning: passing argument 2 of 'frexp' from incompatible pointer type
```

Executing the generated code on the MATLAB host could lead to memory corruption. For example, the function `"double frexp (double value, int *exp);"` expects `'int *'` as the second argument, for which `'int16_T *'` is passed in the generated code. But on the MATLAB host, `int16_T` is redefined to `short`, and during SIL execution, `frexp` will attempt to write 4 bytes to a 2 byte location.

A potential workaround for the SIL workflow is to provide a custom Code Replacement Library (CRL) entry for functions that write to address

locations obtained through pointer arguments. In the above example, the function `frexp` is called by the reciprocal square root operation (`rSqrt`) and `rSqrt` is replaceable using CRLs. Therefore, you can provide a custom version of `rSqrt` to support SIL execution. The replacement function would perform the change in memory allocation for the data accessed by the pointer variable, perhaps by introducing a temporary variable and transferring the data to and from that variable. For more information about CRLs, see “Introduction to Code Replacement Libraries” on page 23-2.

Emulation Hardware

Use this option only if you need to work around a limitation of portable word sizes. You cannot use PIL mode with this option.

See “Platform Options for Development and Deployment” in the Simulink Coder documentation.

To configure a model to use emulation hardware, set the following model configuration parameters.

Set...	To...
Code Generation > Verification > Enable portable word sizes	Clear this checkbox
Hardware Implementation > Emulation hardware > None	Clear this checkbox
Hardware Implementation > Emulation hardware > Device vendor	Generic
Hardware Implementation > Emulation hardware > Device type	MATLAB Host Computer

For an example of how to configure a model to maintain bit-true agreement between host simulation and target deployment, and generate code that is portable between the host and target systems, see `rtwdemo_sil_hardware_config`.

Embedded hardware configured for host

Use this option only if the embedded hardware settings match the host, e.g., to generate code for the host platform.

To configure a model to use emulation hardware, set the following model configuration parameters.

Set...	To...
Code Generation > Verification > Enable portable word sizes	Clear this checkbox
Hardware Implementation > Emulation hardware > None	Clear this checkbox
Hardware Implementation > Embedded hardware	Select settings under Embedded hardware to match your host.

Debugging During SIL Simulations

You can run SIL simulations with the Microsoft Visual Studio® debugger enabled. From the Microsoft Visual Studio IDE, you can insert breakpoints in the generated code and use the debugger to execute code between breakpoints.

For example, if you notice differences between the results of a Normal mode and SIL mode simulation, you can rerun the SIL simulation with the Microsoft Visual Studio debugger enabled. By inserting breakpoints, you can observe the behavior of code sections, which might help you to understand the cause of the differences in results.

To enable the Microsoft Visual Studio debugger for a SIL simulation, on the **Configuration Parameters > Code Generation > Verification** pane, select the **Enable source-level debugging for SIL simulations** check box.

Note The software supports SIL debugging for only the following compilers:

- Microsoft Visual C++ 2010 Professional
 - Microsoft Visual C++ 2008 Professional SP1
-

When you rerun your SIL simulation, your *model.c* or *model.cpp* file opens in the Microsoft Visual Studio IDE with debugger breakpoints at the start of the `model_initialize` and `model_step` functions.

```

Solution Explorer
Solution 'tp2d0d6316_c327'
  rtwdemo_sil_topmodel

rtwdemo_sil_topmodel.c
(Unknown Scope)

void rtwdemo_sil_topmodel_step(void)
{
    /* Logic: '<Root>/Logical Operator2' incorporates:
     * Inport: '<Root>/count_enable'
     * Inport: '<Root>/counter_mode'
     * Logic: '<Root>/Logical Operator'
     */
    enableA = ((!rtU.counter_mode) && rtU.count_enable);

    /* Outputs for Enabled SubSystem: '<Root>/CounterTypeA' */
    CounterTypeA();

    /* End of Outputs for SubSystem: '<Root>/CounterTypeA' */

    /* Logic: '<Root>/Logical Operator1' incorporates:
     * Inport: '<Root>/count_enable'
     * Inport: '<Root>/counter_mode'
     */
    enableB = (rtU.counter_mode && rtU.count_enable);

    /* Outputs for Enabled SubSystem: '<Root>/CounterTypeB' */
    CounterTypeB();

    /* End of Outputs for SubSystem: '<Root>/CounterTypeB' */
}

/* Model initialize function */
void rtwdemo_sil_topmodel_initialize(void)
{
}
100 %

```

You can now use the debugger features to observe code behaviour. For example, you can step through code and examine variables.

To end the debugging session:

- 1 Remove all breakpoints.
- 2 Click the Continue button (F5).

The SIL simulation runs to completion and the Microsoft Visual Studio IDE closes automatically.

Note In the Microsoft Visual Studio IDE, if you select **Debug > Stop Debugging**, the SIL simulation times out with the following error message:

The timeout of 1 seconds for receiving data from the rtiostream interface has been exceeded. There are multiple possible causes for this failure.

...
...

Programming PIL Support Using Third-Party Tools

You can use the Processor-in-the-loop (PIL) Connectivity API to apply the power of PIL verification to object code compiled for your target processor. There are many custom or third-party tools for building, downloading, and communicating with an executable on a target environment. Use the API to integrate your tools for:

- Building the PIL application (an executable for the target hardware)
- Downloading and running the executable
- Communicating with the executable

You can use PIL with target hardware or instruction set simulators, and combination of tools that provide the required level of automation. For hardware cases that MathWorks does not support, see “SIL and PIL Simulation Support and Limitations” on page 31-55.

For instructions and examples on PIL and the Target Connectivity API, see:

- “Configure a SIL or PIL Simulation” on page 31-15
- “Create a Connectivity Configuration for a Target” on page 31-40
- “Examples of the Target Connectivity API” on page 31-51

Create a Connectivity Configuration for a Target

In this section...

- “What Is a PIL Connectivity Configuration?” on page 31-40
- “Overview of the Target Connectivity API” on page 31-41
- “Create a Connectivity API Implementation” on page 31-46
- “Register a Connectivity API Implementation” on page 31-47
- “Synchronize Host and Target” on page 31-47
- “Specify Hardware Timer” on page 31-48
- “Examples of the Target Connectivity API” on page 31-51

What Is a PIL Connectivity Configuration?

You can use PIL connectivity configurations and the target connectivity API to customize PIL to work with a target environment.

Use a connectivity configuration to define:

- A configuration name
- A connectivity API implementation
- Settings that define the set of Simulink models that the configuration is compatible with, for example, the set of models that have a particular system target file, template makefile, and hardware implementation.

You can use the API to integrate third party tools for:

- Building the PIL application, an executable for the target hardware
- Downloading and running the executable
- Communicating with the executable

A particular connectivity configuration name is associated with a single connectivity API implementation. M different connectivity configurations can coexist and be available for use with PIL simulations. You register each

connectivity configuration to Simulink by creating an `sl_customization.m` file and placing it on the MATLAB path.

To run a PIL simulation, the software must first determine which of the available connectivity configurations to use. The software looks for a connectivity configuration that is compatible with the model under test. If the software finds multiple or no compatible connectivity configurations, you see an error message describing how to resolve the problem.

For information on how you create a connectivity configuration for a target, see:

- 1 “Overview of the Target Connectivity API” on page 31-41
- 2 “Create a Connectivity API Implementation” on page 31-46
- 3 “Register a Connectivity API Implementation” on page 31-47

Overview of the Target Connectivity API

- “Target Connectivity API Components” on page 31-41
- “Communications rtiostream API” on page 31-42
- “Test an rtiostream Driver” on page 31-44

Target Connectivity API Components

The following diagram shows what functions the Target Connectivity API components perform:

- Configuring the build process
- Controlling communication between Simulink and the target
- Downloading, starting, and stopping the application on the target

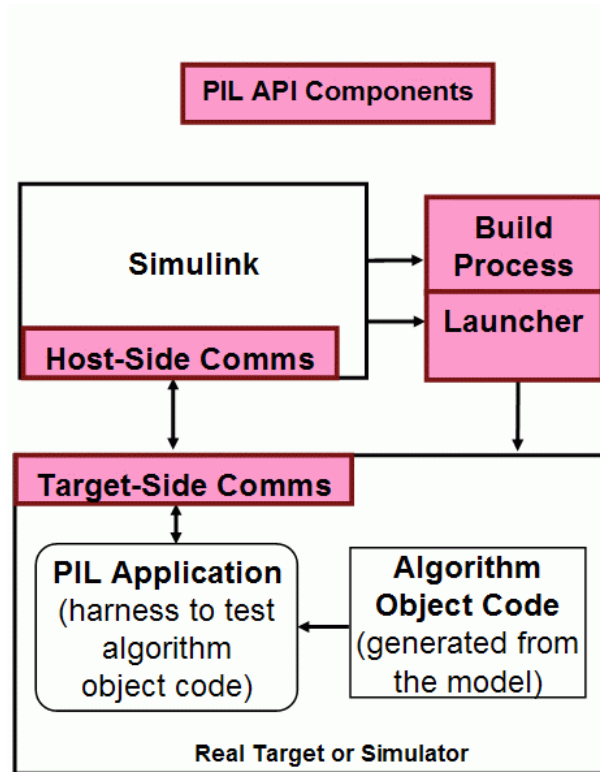

Communications rtiostream API

The communications part of the target connectivity API builds upon the `rtiostream` API, described in this section.

You can use the `rtiostream` API to implement a communication channel to enable exchange of data between different processes. This communication channel is required to enable processor-in-the-loop (PIL) on a new target.

PIL requires a host-target communications channel. This communications channel comprises driver code that runs on the host and target. The `rtiostream` API defines the signature of both target-side and host-side functions that must be implemented by this driver code.

The API is independent of the physical layer that sends the data. Possible physical layers include RS232, Ethernet, or Controller Area Network (CAN).

A full `rtiostream` implementation requires both host-side and target-side drivers. Code generation software includes host-side drivers for the default TCP/IP implementation as well as a version for serial communications. To use the TCP/IP `rtiostream` communications channel, you must provide, or obtain from a third party, target-specific TCP/IP device drivers. You must also do this if you require serial communications. For other communication channels and platforms, there is no default implementation provided by the code generation software. You must provide both the host-side and the target-side drivers.

The `rtiostream` API comprises the following functions:

- `rtIOStreamOpen`
- `rtIOStreamSend`
- `rtIOStreamRecv`
- `rtIOStreamClose`

You can use `rtiostream_wrapper` to test the `rtiostream` shared library methods from MATLAB code.

For information about how the `rtiostream` functions fit into the workflow of creating a connectivity implementation, see “Create a Connectivity API Implementation” on page 31-46.

Test an rtiostream Driver

Use a test suite to debug and verify the behavior of custom `rtiostream` interface implementations.

The test suite has the following advantages:

- Reduces time for integrating custom hardware that does not have built-in `rtiostream` support.
- Reduces time for testing custom `rtiostream` drivers.
- Helps analyze the performance of custom `rtiostream` drivers.

The test suite has two parts. One part of the test suite runs on the target.

Note After building the target application, download it to the target and run it.

To launch this part, compile and link the following files, which are in `matlabroot/toolbox/coder/rtiostream/src/rtiostreamtest`.

- `rtiostreamtest.c`
- `rtiostreamtest.h`
- `rtiostream.h` (located at `matlabroot/rtw/c/src/`)
- `rtiostream` implementation under investigation (e.g., `rtiostream_tcpip.c`)
- `main.c`

To run the MATLAB part of the test suite, invoke `rtiostreamtest`. The syntax is as follows:

```
function rtiostreamtest(connection,param1,param2)
```

- `connection` is a string indicating the communication method. It can have values `'tcp'` or `'serial'`.
- `param1` and `param2` have different values depending on the value of `connection`.

- If connection is 'tcp': param1,param2 are hostname and port, respectively.
- If connection is 'serial': param1,param2 are COM port and baud rate, respectively.

For example, you can run the MATLAB part of the test suite as follows:

```
function rtiostreamtest('tcp','localhost','2345')
```

An output in the following format appears in the MATLAB window:

```
### Test suite for rtiostream ###
Initializing connection with target...

### Hardware characteristics discovered
Size of char      : 8 bit
Size of short     : 16 bit
Size of int       : 32 bit
Size of long      : 32 bit
Size of float     : 32 bit
Size of double    : 64 bit
Size of pointer   : 64 bit
Byte ordering     : Little Endian

### rtiostream characteristics discovered
Round trip time  : 0.96689 ms
rtIOStreamRecv  behavior : non-blocking

### Test results
Test 1 (fixed size data exchange): ..... PASS
Test 2 (varying size data exchange): ..... PASS

### Test suite for rtiostream finished successfully ###
```

Furthermore, the following profile appears.

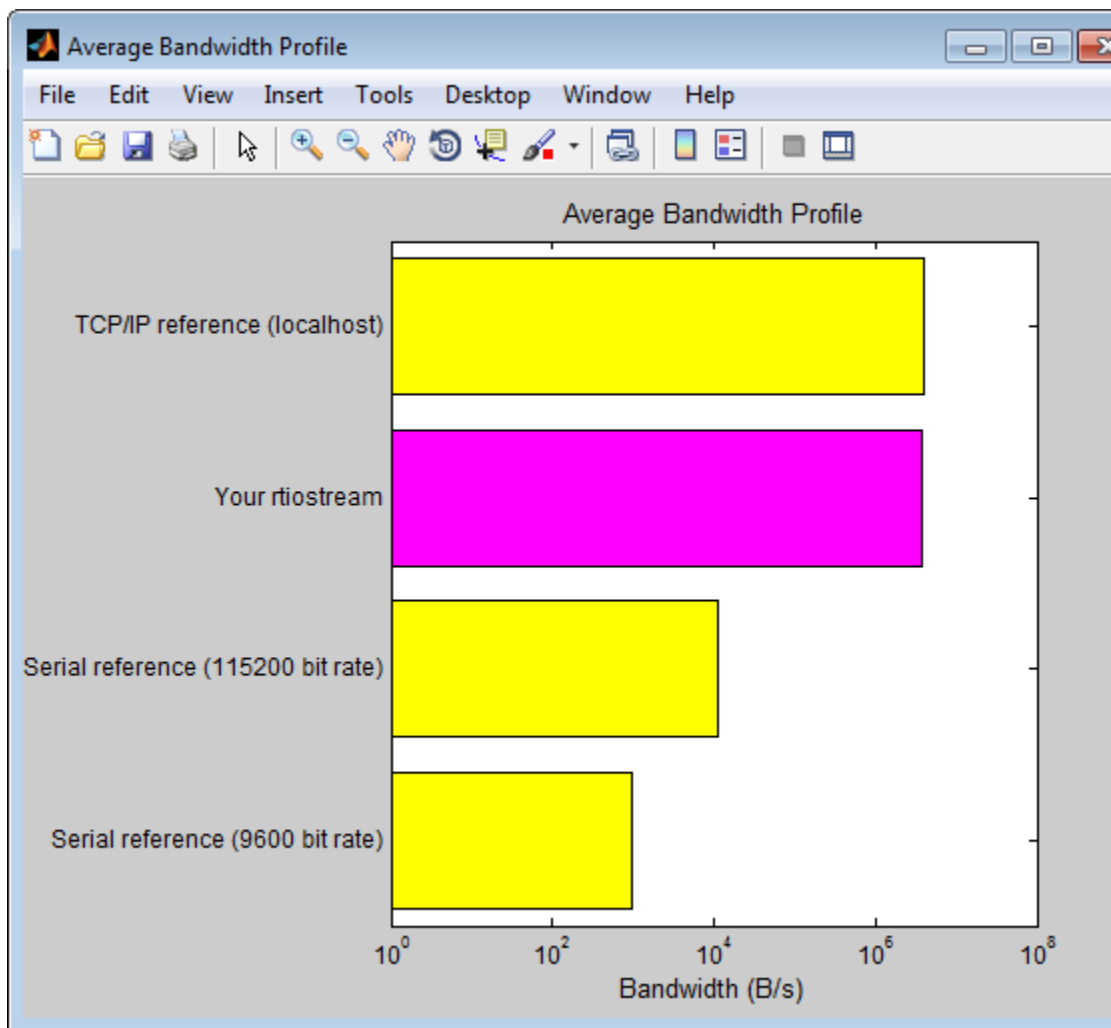

Create a Connectivity API Implementation

To create a target connectivity API implementation, you must create a subclass of `rtw.connectivity.Config`.

- You must instantiate `rtw.connectivity.MakefileBuilder`. This class configures the build process.

- You must create a subclass of `rtw.connectivity.Launcher`. This class downloads and executes the application using a third-party tool.
- Configure your `rtiostream` communications implementation:
 - On the target-side, integrate the driver code implementing `rtiostream` functions directly into the build process by creating a subclass of `rtw.pil.RtIOStreamApplicationFramework`.
 - On the host-side, compile the driver code into a shared library. You load and initialize this shared library by instantiating (or optionally, customizing) `rtw.connectivity.RtIOStreamHostCommunicator`.
- If you want to carry out code execution profiling, you must create a timer object that provides details of the hardware-specific timer and associated source files. See “Specify Hardware Timer” on page 31-48.

Note Each time you modify a connectivity implementation, close and reopen the models to refresh.

See also:

- “Creating Subclasses — Syntax and Techniques” in MATLAB documentation.
- `rtwdemo_custom_pil_script` for an example that helps you to create a target connectivity configuration using the Target Connectivity API

Register a Connectivity API Implementation

Register the new connectivity API implementation to Simulink as a connectivity configuration, by creating or adding to an `sl_customization.m` file. By doing this, you also define the set of Simulink models that the new connectivity configuration is compatible with.

For details, see `rtw.connectivity.ConfigRegistry`.

Synchronize Host and Target

If you use the `rtiostream` API to implement the communications channel, the host and target must be synchronized, which prevents Simulink from

transmitting and receiving data before the target application is fully initialized.

To synchronize the host and target for TCP/IP `rtiostream` implementations, use the `setInitCommsTimeout` method from `rtw.connectivity.RtIOStreamHostCommunicator`. This approach works well for connection-oriented TCP/IP `rtiostream` implementations because Simulink automatically waits until the target server is running.

With other `rtiostream` implementations, for example, `serial`, the Simulink side of the `rtiostream` connection will open without waiting for the target to be fully initialized. In this case, you must make your `Launcher` implementation wait until the target application is fully initialized. Use one of the following approaches to synchronize your host and target:

- Add a pause at the end of the `Launcher` implementation that makes the `Launcher` wait until target initialization is complete.
- In the `Launcher` implementation, use third-party downloader or debugger APIs that wait until target initialization is complete.
- Implement a handshaking mechanism in the `Launcher` / `rtiostream` implementation to confirm that target initialization is complete.

Specify Hardware Timer

If you want to carry out code execution profiling, you must create a timer object that provides details of the hardware-specific timer and associated source files. You can use the Code Replacement Tool or the code replacement library API to specify this hardware-specific timer.

To specify the timer with the Code Replacement Tool:

- 1** Open the Code Replacement Tool. In the Command Window, enter `crtool`.
- 2** Create a new code replacement table. Select **File > New table**.
- 3** Create a new function entry. Under **Tables List**, right-click the new table. Then, from the context-menu, select **New entry > Function**.
- 4** In the middle view, select the new unnamed function.

5 On the **Mapping Information** pane:

- a** From the **Function** drop-down list, select `code_profile_read_timer`.
- b** Specify the count direction for your timer. For example, from the **Count direction** drop-down list, select **Up**.
- c** In the **Ticks per second** field, specify the number of ticks per second for your timer, for example, `1e+09`.

Default value is 0. In this case, the software reports time measurements in terms of ticks, not seconds.

- d** In the **Name** field, specify a replacement function name, for example, `MyTimer`.
- e** Click **Apply**.

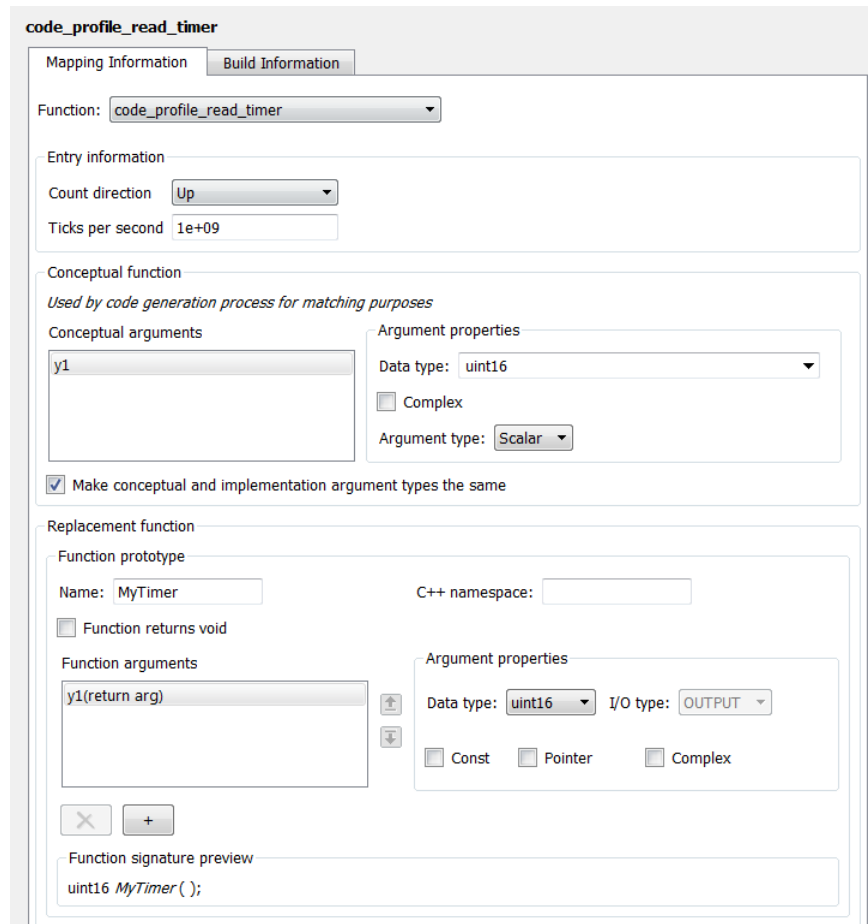

f To validate the function entry, click **Validate entry**.

6 On the **Build Information** pane, specify the required build information. See “Code Replacement Tool” on page 23-168.

7 Save the table (**Ctrl+S**). When you save the table for the first time, use the Save As dialog box to specify the file name and location.

You must save the table in a location that is on the MATLAB search path. For example, you can save this file in the folder for your subclass of `rtw.connectivity.Config`.

The software stores your timer information as a code replacement library table.

- 8 In your subclass of `rtw.connectivity.Config`, add the following line:

```
this.setTimer('MyCr1Table')
```

MyCr1Table is the name of the file that you saved in step 7.

For detailed information about using the Code Replacement Tool or the code replacement library API, see “Code and Operator Replacement”.

Examples of the Target Connectivity API

For step-by-step examples, see the following examples:

- `rtwdemo_custom_pil_script`

This example shows you how to create a custom PIL implementation using the target connectivity APIs. You can examine the code that configures the build process to support PIL, a tool to use for downloading and execution, and a communication channel between host and target. Follow the steps in the example to activate a full host-based PIL configuration.

- `rtwdemo_rtiostream_script`

This example shows you how to implement a communication channel for use with the Embedded Coder product and your embedded target. This communication channel enables exchange of data between different processes. PIL simulation requires this because it requires exchange of data between the Simulink software running on your host computer and deployed code executing on target hardware.

The `rtiostream` interface provides a generic communication channel that you can implement in the form of target connectivity drivers for a range of connection types. The example shows how to configure your own target-side driver for TCP/IP, to operate with the default host-side TCP/IP driver. The default TCP/IP communications allow high bandwidth communication between host and target, which you can use for transferring data such as video.

The example also shows how to implement custom target connectivity drivers, for example, using serial, CAN, or USB for both host and target sides of the communication channel.

View Test Harness in Code Generation Report

With top-model and Model block SIL and PIL simulations, you can produce a code generation report and static code metrics that cover SIL and PIL test harness files. The information helps you to:

- Understand and review the SIL and PIL verification process.
- See how your registered custom target connectivity files fit into the target application that runs during a SIL or PIL simulation.

This feature is not supported for simulations that you run with the PIL block.

To configure the creation of a code generation report and static code metrics, on the **Configuration Parameters > Code Generation > Report** pane, select the **Create code generation report** and **Static code metrics** check boxes. Then click **OK**. For more information about:

- Code generation reports, see “HTML Code Generation Report Extensions” on page 18-2
- Static code metrics, see “Static Code Metrics” on page 18-25

At the end of the simulation, the software displays test harness files and the corresponding static code metrics in the code generation report.

3. Function Information [hide]

View function metrics in a call tree format or table format. Accumulated stack numbers include the estimated stack size of the function plus the maximum of the accumulated stack size of the subroutines that the function calls.

View: Call Tree | [Table](#)

Function Name	Accumulated Stack Size (bytes)	Self Stack Size (bytes)	Lines of Code	Lines
[-] main	1,552	12	22	32
[+] xilInit	1,540	4	7	10
[+] xilTerminateComms	540	8	7	9
[-] xilRun	430	29	191	222
[+] processData	401	9	49	61
[+] finalizeCommandResponse	393	1	14	21
[+] xilReadData	384	24	22	28
[+] xilInitialize	4	4	8	12
xilInitializeConditions	4	4	7	11
xilGetTypeInfo	0	0	1	3
xilProcessParams	0	0	4	7
[-] xilOutput	0	0	11	14
[-] rtwdemo_sil_topmodel_step	0	0	5	26
CounterTypeA	0	0	11	43
CounterTypeB	0	0	8	31
xilTerminate	0	0	4	8
xilEnable	0	0	5	9
xilDisable	0	0	5	9
xilUpdate	0	0	5	9

The software displays the test harness files in the **Interface files** category.

Note You must not use files from the SIL/PIL test harness in code development as these files may change over releases. Use supplied APIs for code development.

SIL and PIL Simulation Support and Limitations

In this section...

“About SIL and PIL Simulation Support and Limitations” on page 31-56

“Code Source Support” on page 31-57

“Block Support” on page 31-60

“Configuration Parameters Support” on page 31-62

“I/O Support” on page 31-70

“Hardware Implementation Support” on page 31-82

“Other Feature Support” on page 31-84

About SIL and PIL Simulation Support and Limitations

Top-model and Model block software-in-the-loop (SIL) and processor-in-the-loop (PIL) simulation modes, and SIL and PIL blocks are Embedded Coder features.

The following tables summarize the support provided for top-model SIL and PIL, Model block SIL and PIL and the SIL or PIL block. “Yes” indicates a supported feature.

Information on selected aspects of SIL and PIL is also provided, especially unsupported features and limitations.

Code Source Support

Code Source	Code Interface	Top-Model SIL/PIL	Model Block SIL/PIL	SIL Block	PIL Block
Top model	Standalone	Yes	No	Yes	Yes
Atomic subsystem	Standalone	No	No	Yes	Yes
Virtual subsystem	Standalone	No	No	Yes, but recommend atomic subsystem. See “Algebraic Loop Issues” on page 31-64	Yes, but recommend atomic subsystem. See “Algebraic Loop Issues” on page 31-64.
Model block	Model reference target	No, but you can include Model blocks inside your top model.	Yes. See “Conditionally Executed Subsystem” on page 31-59	No, but you can include Model blocks inside your model.	No, but you can include Model blocks inside your model.
Enabled/ Triggered subsystem	Standalone	No	No	Yes	Yes
Export Functions subsystem	Export Functions	N/A	N/A	Yes	Yes. See “PIL Block Export Functions” on page 31-59.
Legacy code	Custom	See “Custom Code Interfaces” on page 31-59.	See “Custom Code Interfaces” on page 31-59.	See “Custom Code Interfaces” on page 31-59.	See “Custom Code Interfaces” on page 31-59.
MATLAB Coder	MATLAB Coder	See “Custom Code Interfaces” on page 31-59.	See “Custom Code Interfaces” on page 31-59.	See “Custom Code Interfaces” on page 31-59.	See “Custom Code Interfaces” on page 31-59.

For more information on code interfaces, see “Code Interfaces for SIL and PIL” on page 31-28.

Custom Code Interfaces

MathWorks does not provide direct SIL/PIL support for code interfaces such as legacy code and MATLAB Coder. However, you can incorporate these interfaces into Simulink as an S-function (for example, using the Legacy Code Tool, S-Function Builder, or handwritten code), and then verify them using SIL/PIL.

SIL/PIL Does Not Check Simulink Coder Error Status

SIL/PIL does not check the Simulink Coder error status of the generated code under test. This error status flags exceptional conditions during execution of the generated code.

The Simulink Coder error status can also be set by blocks in the model (for example, custom blocks developed by a user). It is a limitation that SIL/PIL cannot check this error status and report back errors.

Conditionally Executed Subsystem

You see an error if:

- You place your Model block (in either SIL or PIL simulation mode) in a conditionally executed subsystem and the referenced model is multirate (that is, has multiple sample times). Single rate referenced models (with only a single sample time) are not affected.
- Your Model block (in either SIL or PIL simulation mode) has blocks that depend on absolute time **and** is conditionally executed.

PIL Block Export Functions

The PIL block does not support the export of functions from triggered subsystems. With the PIL block, you can export only function-call subsystems.

Block Support

Blocks	Top-Model SIL/PIL	Model Block SIL/PIL	SIL Block	PIL Block
Model block	Yes, you can include Model blocks inside your top model.	Yes	Yes, you can include Model blocks inside your subsystem or model.	Yes, you can include Model blocks inside your subsystem or model.
DSP System Toolbox	Yes	Yes	Yes	Yes
Computer Vision System Toolbox™	Yes	Yes	Yes	Yes
MATLAB Function block	Yes	Yes	Yes	Yes
Driver blocks	Yes, but not recommended.	Yes, but not recommended.	Yes, but not recommended.	Yes, but not recommended.
To File blocks	Yes, if MAT-file logging is on. MAT-file logging may not be available in PIL mode.	No. MAT-file logging is not supported.	Yes, if MAT-file logging is on.	Yes, if MAT-file logging is supported and on.
To Workspace blocks	Yes, if MAT-file logging is on. MAT-file logging may not be available in PIL mode.	No, MAT-file logging is not supported.	Yes, if MAT-file logging is on.	Yes, if MAT-file logging is supported and on.

Blocks	Top-Model SIL/PIL	Model Block SIL/PIL	SIL Block	PIL Block
Merge blocks	Yes	Yes. Cannot connect SIL/PIL outputs to Merge blocks. See “Merge Block Issue” on page 31-61.	Yes. Cannot connect SIL outputs to Merge blocks. See “Merge Block Issue” on page 31-61.	Yes. Cannot connect PIL outputs to Merge blocks. See “Merge Block Issue” on page 31-61.
Stop block	No. SIL/PIL ignores the Stop Simulation block and continues simulating.	No. SIL/PIL ignores the Stop Simulation block and continues simulating.	No. SIL ignores the Stop Simulation block and continues simulating.	No. PIL ignores the Stop Simulation block and continues simulating.
Scope blocks, and all types of run-time display For example, display of port values and signal values	No	No	No	No

Merge Block Issue

If you connect SIL/PIL outputs to a Merge block, you see an error because S-function memory is not reusable.

Other Top-Model SIL/PIL Limitations

SIL/PIL does not support the callbacks (model or block) StartFcn and StopFcn.

Note Top-model SIL/PIL supports the callback InitFcn.

Configuration Parameters Support

Configuration Parameters	Top-Model SIL/PIL	Model Block SIL/PIL	SIL Block	PIL Block
ERT-based system target file	Yes	Yes	Yes	Yes
AUTOSAR system target file	Yes. See “Use the SIL and PIL Simulation Modes” on page 17-89.	Yes. See “Use the SIL and PIL Simulation Modes” on page 17-89.	Yes. See “Use a SIL or PIL Block for AUTOSAR Verification” on page 17-90.	Yes. See “Use a SIL or PIL Block for AUTOSAR Verification” on page 17-90.
GRT-based system target file	No	No	No	No
Classic call interface	No; see “Missing Code Interface Description File Errors” on page 31-64.	No; see “Missing Code Interface Description File Errors” on page 31-64.	No	No; see “Missing Code Interface Description File Errors” on page 31-64.
Function Prototype Control	Yes	Yes	Yes	Yes
Reusable code format	Yes, but see the special cases in “Imported Data Definitions” on page 31-76.	N/A	Yes	Yes, but see the special cases in “Imported Data Definitions” on page 31-76.
Code replacement library	Yes	Yes	Yes	Yes
C++	Yes	Yes	Yes	Yes

Configuration Parameters	Top-Model SIL/PIL	Model Block SIL/PIL	SIL Block	PIL Block
C++ (Encapsulated)	Yes	Yes	Yes	Yes
Generate ASAP2 file	Yes	Yes	Yes	Yes
Generate example main	N/A	N/A	N/A	N/A
MAT-file logging	Yes. For PIL, the target environment may not support MAT-file logging.	No	Yes	Yes, if the target environment supports MAT-file logging.
Signal logging	Yes, for internal signals and for signals connected to root-level inports and outports. See “Internal Signal Logging Support” on page 31-66, “Top-Model Root-Level Logging Limitations” on page 31-67.	Yes. See “Internal Signal Logging Support” on page 31-66	No, but see “Verify Internal Signals of a Component” on page 31-24.	No, but see “Verify Internal Signals of a Component” on page 31-24.
‘Simplified’ model initialization	Yes	Yes	Yes	Yes

Configuration Parameters	Top-Model SIL/PIL	Model Block SIL/PIL	SIL Block	PIL Block
Single output/update	Yes, but see “Algebraic Loop Issues” on page 31-64.	Yes, but see “Algebraic Loop Issues” on page 31-64.	Yes, but see “Algebraic Loop Issues” on page 31-64.	Yes, but see “Algebraic Loop Issues” on page 31-64.
Configuration set reference	Yes	Yes	Yes	Yes

- “Missing Code Interface Description File Errors” on page 31-64
- “Algebraic Loop Issues” on page 31-64
- “Internal Signal Logging Support” on page 31-66
- “Top-Model Root-Level Logging Limitations” on page 31-67

Missing Code Interface Description File Errors

SIL/PIL requires a code interface description file, which is generated during the code generation process for the component under test. If the code interface description file is missing, the SIL/PIL simulation cannot proceed and you see an error reporting that the file does not exist. This error can occur if you select the unsupported option **Classic call interface** in your configuration parameters. Do not select this option.

Algebraic Loop Issues

For more information on algebraic loops, see:

- “Algebraic Loops” in the Simulink documentation.
- The Algebraic Loops section in “Modeling Semantic Considerations”.
- “Code Generation of Subsystems”.

There are three ways that PIL simulation can introduce algebraic loops that do not exist for a normal simulation:

- “Algebraic Loops Caused by Code Generation for a Virtual Subsystem” on page 31-65

- “Algebraic Loops Caused by “Single output/update function”” on page 31-65
- “Algebraic Loops Caused by SIL/PIL Scheduling Limitations” on page 31-65

Algebraic Loops Caused by Code Generation for a Virtual Subsystem.

If you generate code for a virtual subsystem, code generation treats the subsystem as atomic and generates the code accordingly. The resulting code can change the execution behavior of your model, for example, by applying algebraic loops, and introduce inconsistencies to the simulation behavior.

Declare virtual subsystems as atomic subsystems to enable consistent simulation and execution behavior for your model. For more information, see “Code Generation of Subsystems”

Algebraic Loops Caused by “Single output/update function”. The “single output/update function” in code generation optimization can introduce algebraic loops because it introduces direct feedthrough via a combined output and update function.

This option is not compatible with the **Minimize algebraic loop occurrences** option (in the Subsystem Parameters dialog box and **Model Referencing** pane of the Configuration Parameters dialog box). This option allows code generation to remove algebraic loops by partitioning generated code between output and update functions to avoid direct feedthrough.

Algebraic Loops Caused by SIL/PIL Scheduling Limitations. The S-function scheduling mechanism that the software uses to execute the SIL/PIL component has the following limitations:

- Direct feedthrough is set to true.
- Separate output and update functions in the SIL/PIL component are executed from the mdlOutputs S-function callback.

These limitations mean that SIL/PIL can introduce algebraic loops that do not exist in normal simulation, and you might get incorrect results. If this happens, you see a warning or error about the introduced algebraic loop and SIL/PIL results may differ from simulation results. You do not see a warning or error if **Configuration Parameters > Diagnostics > Algebraic loop** is set to none.

A workaround is to break the algebraic loop by inserting a Unit Delay block so that the algebraic loop does not occur. You can then use SIL/PIL.

Internal Signal Logging Support

You can use Simulink signal logging with the SIL and PIL simulation modes, with both top-model SIL or PIL and Model block (referenced model) SIL or PIL. This allows you to:

- Collect signal logging outputs (e.g., `logout`) during SIL and PIL simulations.
- Log the internal signals and the root-level outputs of a SIL or PIL component.
- Manage the SIL and PIL signal logging settings using the Simulink Signal Logging Selector.
- More easily compare logged signals between normal, SIL, and PIL simulations, for example, using Simulation Data Inspector.

SIL or PIL signal logging requires the following model configuration settings:

- On the **Data Import/Export** pane of the Configuration Parameters dialog box, set **Signal logging format** to Dataset.
- On the **Code Generation > Interface** pane of the Configuration Parameters dialog box, set **Interface** to C API.

The C API is used to determine the addresses of the internal signals that need to be logged. See also “Internal Signal Logging Limitations” on page 31-66.

Internal Signal Logging Limitations.

- The C API requires that support for floating-point numbers is selected (see **Configuration Parameters > Code Generation > Interface > Support > floating-point numbers**).
- Only signals that are included in the C API are logged during SIL/PIL simulation. You might need to configure signals as test points (see **Signal Properties > Test point**) to check that they are observable in the generated code.

- Logging of signals in models referenced by the SIL/PIL component is not supported. Only signals within the top-level of the SIL/PIL component are logged.
- Virtual signals (e.g. MUX) are not supported.
- Buses are not supported.
- Custom storage classes are not supported.
- Continuous, asynchronous and triggered sample times are not supported.
- Logging of Stateflow States and Local Data is not supported.

With top-model internal signal logging, some additional limitations apply:

- Variable-size signals, Function-call signals, and Action signals: error for normal simulation and warning for SIL/PIL.
- State port signals: error for normal simulation; no warning for SIL/PIL.
- Signals feeding merge blocks are not supported for logging in normal simulation but are logged in SIL/PIL mode. The logged values during SIL/PIL will be the same as the logged values for the output of the merge block.
- Under the following circumstances, top-model Normal simulation logs data at a periodic rate, but top-model SIL/PIL simulation logs data at the constant rate:
 - **Inline parameters** is not selected.
 - A constant sample time signal from a Model block is logged in the top model.
 - The logged signal is not directly connected to a root-level output port. To avoid this behaviour, select **Inline parameters** to log at constant rate in all simulation modes.

Top-Model Root-Level Logging Limitations

Top-model SIL/PIL supports signal logging for signals connected to root-level inports and outports. Both ModelDataLogs and Dataset signal logging formats are supported, and the C API is not required. Root-level logging has the following limitations:

- The characteristics of the logged data such as data type and dimensions match the characteristics of the root-level inports and outports rather than the characteristics of the connected signal.

In some cases, there may be differences in data type and dimensions between the signal being logged and the root inport or outport that the signal is connected to. Consider the following examples.

- If a signal being logged has matrix dimensions [1x5] but the outport connected to the signal has vector dimensions (5), then the data logged during a SIL or PIL simulation has vector dimensions (5).
 - If a signal being logged has scalar dimensions but the outport connected to the signal has matrix dimensions [1x1], then the data logged during a SIL or PIL simulation has matrix dimensions [1x1].
- Signals connected to duplicated inports are not logged during SIL/PIL simulation. No warning is issued.

During normal simulation, signals connected directly to duplicated inports are logged.

- The Signal Logging Selector / DataLoggingOverride override mechanism is not supported.
- There is no support for signals that are not named.
- The Normal and SIL/PIL simulations for a top model produce logged bus signals with names that are different when all of the following conditions apply:
 - The signal logging format is Dataset.
 - The names of the elements in the bus signal are different from the corresponding names in the bus object.
- Under the following circumstances, the software adds the suffix `_wrapper` to the block path for signals in `logout` and to the block name for signals in `yout`.
 - For *signal logging*, if you specify the signal logging format to be `ModelDataLogs`, the software adds the suffix `_wrapper` to the block path for signals in `logout`, as shown in the following example:

```
>> logout.SignalLogging
```



```

        Name: 'SignalLogging'
        BlockPath: 'sillogging_wrapper/sillogging'
        PortIndex: 1
        SignalName: 'SignalLogging'
        ParentName: 'SignalLogging'
        TimeInfo: [1x1 Simulink.TimeInfo]
                Time: [11x1 double]
                Data: [11x1 double]

```

To avoid this behavior, use the Dataset signal logging format. See `Simulink.SimulationData.Dataset`.

- For *output logging*, if the save format is Structure or Structure with time and you run the `sim` command without specifying the single-output format, the software adds the suffix `_wrapper` to the block name for signals in `yout`, as shown in the following example:

```

>> yout.signals

ans =
    values: [11x1 double]
  dimensions: 1
    label: 'SignalLogging'
  blockName: 'sillogging_wrapper/OutputLogging'

```

If the save format is Array, then the software does not add a wrapper suffix.

To avoid this behavior, run command-line simulations with the `sim` command specifying the single-output format. See “Run Simulation Using the `sim` Command”.

I/O Support

I/O	Top-Model SIL/PIL	Model Block SIL/PIL	SIL Block	PIL Block
Tunable parameters (Model reference arguments)	N/A	Yes. See “Tunable Parameters and SIL/PIL” on page 31-74.	N/A	N/A
Tunable parameters (Workspace variables)	No	Yes. See “Tunable Parameters and SIL/PIL” on page 31-74.	Yes	Yes. See “Tunable Parameters and SIL/PIL” on page 31-74.
Virtual buses	No	Yes	Yes	Yes, but some limitations at PIL component boundary; see “PIL Block Virtual Bus Support Limitations” on page 31-80.
Nonvirtual buses	Yes, but see “Top-Model SIL/PIL Bus Limitations” on page 31-80.	Yes	Yes	Yes
MUX/DEMUX	No	Yes	Yes	Yes, but see “PIL Block MUX Support Limitations” on page 31-81.
Vector/2D/ Multidimensional	Yes	Yes	Yes	Yes

I/O	Top-Model SIL/PIL	Model Block SIL/PIL	SIL Block	PIL Block
Complex data	Yes	Yes	Yes	Yes
Fixed-point data	Yes	Yes	Yes	Yes
Complex fixed-point data	Yes	Yes	Yes	Yes
Fixed-point data type override	Not at SIL or PIL component boundary. See “Fixed-Point Tool Data Type Override” on page 31-79	Not at SIL or PIL component boundary. See “Fixed-Point Tool Data Type Override” on page 31-79.	Yes	Not at PIL component boundary. See “Fixed-Point Tool Data Type Override” on page 31-79.
Data type replacement	Yes, but see “Data Type Replacement Limitation” on page 31-80	Yes, but see “Data Type Replacement Limitation” on page 31-80	Yes	Yes, but see “Data Type Replacement Limitation” on page 31-80
Goto/From I/O	N/A	N/A	Yes	Goto / From blocks must not cross the PIL component boundary. You can use Goto / From blocks to route buried signals up to top-level Inports and Outports <i>inside</i> the PIL component.

I/O	Top-Model SIL/PIL	Model Block SIL/PIL	SIL Block	PIL Block
Global data store I/O	Yes. See “Global Data Store Support” on page 31-76 and “Imported Data Definitions” on page 31-76.	Yes. See “Global Data Store Support” on page 31-76 and “Imported Data Definitions” on page 31-76.	Yes. See “Global Data Store Support” on page 31-76.	Yes. See “Global Data Store Support” on page 31-76 and “Imported Data Definitions” on page 31-76.
Local data store I/O	No. See “Imported Data Definitions” on page 31-76.	No. See “Imported Data Definitions” on page 31-76.	Yes	No. See “Imported Data Definitions” on page 31-76.
Non-port-based sample times	Yes	Yes	Yes	Yes
Continuous sample times	Not at SIL or PIL component boundary.	No	No	Not at PIL component boundary.
Outputs with constant sample time	Yes	No	Yes	Yes
Non-auto-storage classes for data (such as signals, parameters, data stores)	Yes. See “Imported Data Definitions” on page 31-76.	Yes. See “Imported Data Definitions” on page 31-76.	Yes	Yes. See “Imported Data Definitions” on page 31-76.
Simulink data objects	Yes	Yes	Yes	Yes
Simulink numeric type and alias type	Yes	Yes	Yes	Yes

I/O	Top-Model SIL/PIL	Model Block SIL/PIL	SIL Block	PIL Block
Simulink enumerated data	Yes	Yes	Yes	Yes
Custom storage classes	Yes, but see “Imported Data Definitions” on page 31-76, and “GetSet Custom Storage Class” on page 31-77.	Yes, but see “Imported Data Definitions” on page 31-76, and “GetSet Custom Storage Class” on page 31-77.	Yes	Yes, but see “Imported Data Definitions” on page 31-76, and “GetSet Custom Storage Class” on page 31-77.
Variable-size signals	No. See “Variable-Size Signals and SIL/PIL” on page 31-79.	Yes. On the Simulation > Configuration Parameters > Model Referencing pane, in the Propagate sizes of variable-size signals field, specify During execution . Otherwise, software generates error.	Yes	No. See “Variable-Size Signals and SIL/PIL” on page 31-79.
Noninlined S-functions	Yes	No	Yes	Yes

- “Tunable Parameters and SIL/PIL” on page 31-74
- “Global Data Store Support” on page 31-76
- “Imported Data Definitions” on page 31-76
- “GetSet Custom Storage Class” on page 31-77
- “Unsupported Implementation Errors” on page 31-78
- “Variable-Size Signals and SIL/PIL” on page 31-79
- “Fixed-Point Tool Data Type Override” on page 31-79

- “Data Type Overrides Unavailable for Most Blocks in Embedded Targets and Desktop Targets” on page 31-80
- “Data Type Replacement Limitation” on page 31-80
- “Top-Model SIL/PIL Bus Limitations” on page 31-80
- “PIL Block Virtual Bus Support Limitations” on page 31-80
- “PIL Block MUX Support Limitations” on page 31-81
- “Incremental Build for Top-Model SIL/PIL” on page 31-81
- “Exported Functions in Feedback Loops” on page 31-81

Tunable Parameters and SIL/PIL

You can tune parameters during a SIL/PIL mode simulation the same way that you tune parameters during a Normal mode simulation.

For more information, see “Global Tunable Parameters” and “Using Model Arguments” in the Simulink documentation.

The following table summarizes SIL/PIL support for tunable workspace parameters.

Action	Top-Model SIL/PIL	Model Block SIL/PIL	PIL Block
Define and initialize parameters	Yes. See “Limitations” on page 31-74.	Yes. See “Limitations” on page 31-74.	Yes. See “Limitations” on page 31-74.
Tune parameters	Yes. See “Limitations” on page 31-74.	Yes. See “Limitations” on page 31-74.	Yes. See “Limitations” on page 31-74.

Limitations. During a SIL/PIL simulation, the software cannot define, initialize, or tune the following types of tunable workspace parameters. The software produces warnings or errors.

Parameter description	Software response for ...		
	Top-Model SIL/PIL	Model Block SIL/PIL	PIL Block
Parameters with storage class that applies "static" scope or "const" keyword. For example, Custom, Const, or ConstVolatile	Warning	Warning	Warning
Fixed-point parameters with data type size greater than 32 bits	Warning	Error	Warning
Parameters with data types that have different sizes on host and target	Warning	Error	Warning
Structure parameters with storage class SimulinkGlobal	Warning	<i>Supported, so no warning or error</i>	Warning

During a PIL block simulation, the software supports the tuning of *tunable workspace* parameters but not *tunable block dialog* parameters.

For C++ (Encapsulated), SIL/PIL tunable workspace parameters can be tuned, provided the code interface block parameter visibility is set to public.

If you select the configuration parameter **Generate reusable code** but do not select **Inline parameters** and the model contains parameters, then top-Model SIL/PIL and the PIL block can produce errors. If these conditions apply, then the software produces an error similar to the following:

```
Parameter Dialog:InitialOutput in 'rtwdemo_sil_topmodel/CounterTypeA/count'
is part of the imported "rtP" structure in the generated code but cannot be
initialized by SIL or PIL. To avoid this error, make sure the parameter
corresponds to a tunable base workspace variable with a storage class such
```

as SimulinkGlobal and is supported for dynamic parameter initialization / tuning with SIL/PIL.

Global Data Store Support

SIL/PIL supports global data stores. PIL components that access global data stores must be single rate. If your SIL/PIL component has multiple sample times and accesses global data stores, you see an error. To avoid the error, either remove accesses to global data stores or make the component single rate.

Imported Data Definitions

You can use, for example, signals, parameters, and data stores that specify storage classes with imported data definitions.

SIL Block. When you create a SIL block from a model or subsystem, the software defines all imported data in the file *model_or_subsystem_sf.c*. Within models that are referenced by the component, only root-level imported signals are defined.

Model Block SIL/PIL. The SIL/PIL application automatically defines storage for imported data associated with:

- Signals at the root level of the component (on the I/O boundary)
- Parameters. See Tunable Parameters and SIL/PIL Limitations.
- Global data stores

Note Model block SIL/PIL does not define imported signals that are internal with respect to the component or models referenced by the component.

A limitation is that SIL/PIL does not define storage for other imported data storage. You must define the storage through custom code included by the component under test or through the PIL `rtw.pil.RtIOStreamApplicationFramework` API. For example, the PIL application does not define imported data storage for data associated with:

- Internal signals (not on the I/O boundary)
- Local data stores

Top-Model SIL/PIL and PIL Block. The top-model SIL/PIL or PIL block application automatically defines storage for imported data associated with:

- Signals at the root level of the component (on the I/O boundary)
- Global data stores
- Parameters. See Tunable Parameters and SIL/PIL Limitations.

Note Top model SIL/PIL and the PIL block do not define imported signals that are internal with respect to the component or models referenced by the component.

A limitation is that SIL/PIL does not define storage for other imported data storage. You must define the storage through custom code included by the component under test or through the PIL `rtw.pil.RtIOStreamApplicationFramework` API. For example, the SIL/PIL application does not define imported data storage for data associated with:

- Internal signals (not on the I/O boundary)
- Local data stores

GetSet Custom Storage Class

The software supports the `GetSet` custom storage class for all types of SIL and PIL simulations, with one limitation. `GetSet` behavior for the SIL block is different from top-model SIL/PIL, Model block SIL/PIL, and PIL block:

- SIL block — The C definitions of the `Get` and `Set` functions that you provide form part of the algorithm under test.
- Other types of SIL/PIL — The SIL/PIL test harness automatically provides C definitions of the `Get` and `Set` functions that are used during SIL/PIL simulations. In addition, the software supports only *scalar* signals, parameters and global data stores.

Unsupported Implementation Errors

If you use a data store, signal, or parameter implementation that SIL/PIL does not support, you may see errors like the following:

The following *data interfaces* have implementations that are not supported by SIL or PIL.

data interfaces may be global data stores, inports, outports or parameters.

You see this error message because the model output port has been optimized through virtual output port optimization. See “Use Virtualized Output Ports Optimization” on page 25-2. The error occurs because the properties (for example, data type, dimensions) of the signal or signals entering the virtual root output port have been modified by routing the signals in one of the following ways:

- Through a Mux block
- Through a block that changes the signal data type. To check the consistency of data types in the model, display Port Data Types by selecting **Display > Signals & Ports > Port Data Types**.
- Through a block that changes the signal dimensions. To check the consistency of data types in the model, display dimensions by selecting **Display > Signal & Ports > Signal Dimensions**.

Note Dimension changes from scalar (1) to matrix [1x1], and, matrix [1x1] to scalar (1), can lead to this error. Furthermore, it is difficult to inspect the model for such changes because the **Display > Signal & Ports > Signal Dimensions** feature does not distinguish between (1) and [1x1] dimensions. The software shows both signals as scalar signals. Check your model and workspace objects carefully and see that scalar dimensions are specified consistently.

The following model causes this error by changing the output port signal data type.

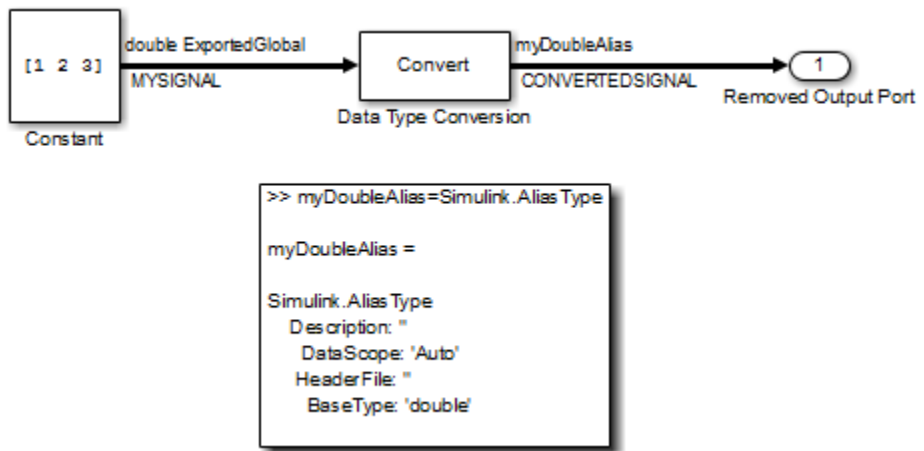

Variable-Size Signals and SIL/PIL

SIL/PIL treats variable-size signals at the I/O boundary of the SIL/PIL component as fixed-size signals, which can lead to errors during propagation of signal sizes. To avoid such errors, use only fixed-size signals at the I/O boundary of the SIL/PIL component.

There may be cases where no error occurs during propagation of signal sizes. In these cases, the software treats variable-size input signals as zero-size signals.

Fixed-Point Tool Data Type Override

SIL/PIL does not support signals with data types overridden by the Fixed-Point Tool **Data type override** parameter at the SIL/PIL component boundary.

You may see an error message like the following:

```

Detected "Scaled double" fixed-point data type override in SIL/PIL interface data,
which is not supported. Use the Fixed-Point Tool to verify that DataTypeOverride
is not "Scaled double"

```

There is no resolution for this issue.

Data Type Overrides Unavailable for Most Blocks in Embedded Targets and Desktop Targets

When you attempt to perform a datatype override on a block, you may get an error message similar to the following example:

```
Error reported by S-function 'sfun_can_frame_splitter' in  
'c2000_host_CAN_monitor/CAN Message Unpacking/CAN Message  
Unpacking': Incompatible DataType or Size specified.
```

Data type overrides using the Fixed point tool are not available for those blocks in Simulink Coder > Desktop Targets and Embedded Coder > Embedded Targets libraries that support fixed-point.

There is no resolution for this issue.

Data Type Replacement Limitation

The software does not support replacement data type names that you define for the built-in data type `boolean` if these names map to either the `int` or `uint` built-in data type.

Top-Model SIL/PIL Bus Limitations

The software does not support grounded or unconnected signals at the outputs of a top model.

You must enable the strict bus mode for top-model SIL/PIL:

- 1** In the model window, select **Simulation > Configuration Parameters > Diagnostics > Connectivity**.
- 2** Set **Mux blocks used to create bus signals** to error.

PIL Block Virtual Bus Support Limitations

The PIL block supports virtual buses except for the following cases:

- You see an error if the PIL component is a top model with a root level output that is configured to output a virtual bus. A root level output outputs a virtual bus, regardless of the type of the bus that drives it, if

it specifies a bus object and the **Output as nonvirtual bus in parent model** check box is not selected.

- You see an error if a right-click subsystem build expands the bus into individual signals.
- For right-click subsystem builds only, the PIL block changes the output of outports driven by virtual buses (with associated bus objects) into nonvirtual buses. You do not see an error message in this case.

To avoid these limitations, use nonvirtual buses at the PIL component boundary.

PIL Block MUX Support Limitations

The PIL block supports mux signals, except mixed data-type mux signals that expand into individual signals during a right-click subsystem build. You see an error for unsupported cases.

Incremental Build for Top-Model SIL/PIL

When you start a top-model SIL/PIL simulation, the software regenerates code if it detects changes to your model. The software detects changes by using a checksum for the model. However, the software does not detect changes that you make to:

- The `HeaderFile` property of a `Simulink.AliasType` object
- Legacy S-functions

Therefore, if you make these changes, you must build (**Ctrl-B**) your model again before starting the next PIL simulation.

Exported Functions in Feedback Loops

If your model has function-call subsystems and you export a subsystem that has context-dependent inputs (for example, feedback signals), then the results of a SIL/PIL simulation with the generated code may not match the results of the Normal mode simulation of your model. One approach to make SIL/PIL and Normal mode simulations yield identical results is to use Function-Call Feedback Latch blocks in your model. This approach allows you to make context-dependent inputs become context-independent.

Note The software generates a warning identifying context-dependent inputs of exported function-call subsystems if you set **Configuration Parameters > Diagnostics > Connectivity > Context-dependent inputs** to one of the following:

- Enable all as warnings
- Use local settings
- Disable all

For details, see “Context-dependent inputs”.

Hardware Implementation Support

Hardware Implementation	Embedded Coder
Different host and target data-type size	No. See “Hardware Implementation Settings” on page 31-82.
Word-addressable targets	Yes. Data type sizes smaller than target word sizes are supported.
Multiword data type word order different to target byte order	No. PIL simulation fails with undefined behavior.
Multiword	No
Size of target 'long' > 32 bits	No

Hardware Implementation Settings

PIL requires that, in the Simulink Configuration Parameters dialog box, you configure the right Hardware Implementation settings for the target environment. You must also specify byte ordering for targets.

Warning If you do not specify the correct Hardware Implementation settings, the PIL simulation fails, displaying undefined behavior.

Host/Target Data Type Size Mismatch. PIL supports only data types that have the same size on the host and the target at the PIL I/O boundary.

The data types used at the PIL I/O boundary are restricted based on the following rule: PIL supports the data type only if the data-type size on the host (Simulink) is the same as the data-type size on the target.

- For `boolean`, `uint8`, and `int8`, the size is 8-bits.
- For `uint16` and `int16`, the size is 16-bits.
- For `uint32` and `int32`, the size is 32-bits.
- For `single`, the size is 32-bits.
- For `double`, the size is 64-bits.

Examples of unsupported data types are:

- `single` and `double` on targets with 24-bit floating-point types
- `double` on targets with 32-bit double, that is, the same size as `single`

Other Feature Support

Other Features	Top-Model SIL/PIL	Model Block SIL/PIL	SIL Block	PIL Block
Multiplatform support (such as Linux)	Yes	Yes	Yes	Yes
Execution profiling	Yes	Yes	No	Yes
Stack profiling	SIL: No. PIL: Depends on target connectivity configuration and third-party product support.	SIL: No. PIL: Depends on target connectivity configuration and third-party product support.	No	Depends on target connectivity configuration and third-party product support.
C code coverage report	Yes. See also “Tips and Limitations” on page 32-18.	Yes. See also “Tips and Limitations” on page 32-18.	No	Depends on target connectivity configuration and third-party product support.
Debugging	SIL: Yes. PIL: No.	SIL: Yes. PIL: No.	Yes	No

Programmatic Code Generation Verification

In this section...

“Code Generation Verification API Overview” on page 31-85

“Verify Numerical Equivalence with CGV” on page 31-85

“Verify Numerical Equivalence Between Two Modes of Execution of a Model” on page 31-86

“Plot Output Signals” on page 31-93

Code Generation Verification API Overview

When you execute a model in different modes of execution, you can use the Code Generation Verification (CGV) API to verify the numerical equivalence of results. CGV supports executing the model in simulation, Software-In-the-Loop (SIL), and Processor-In-the-Loop (PIL). For more information about SIL and PIL, see “About SIL and PIL Simulations” on page 31-2. The CGV example, `rtwdemo_cgv_script`, shows CGV configuration, execution, and comparison support.

Note CGV helps you verify the numerical equivalence of results for a given set of inputs. CGV can detect numerical deviations for the given set of inputs only. The completeness of the input data that you provide to CGV determines the validity of the results.

Verify Numerical Equivalence with CGV

Before verifying numerical equivalence:

- Configure your model for SIL or PIL simulation. For more information, see “Configure a SIL or PIL Simulation” on page 31-15.
- Use the `cgv.Config` class of the CGV API to verify the model configuration for SIL or PIL simulation. For more information, see “Verify a SIL or PIL Configuration” on page 31-20.
- Configure your model for code generation. For more information, see .

- Save your model. If you modify a model without saving it, CGV might issue an error.

To verify numerical equivalence:

- Set up the tests for the first execution environment. For example, simulation.
- Use `cgv.CGV.run` to run the tests for the first execution environment.
- Set up the tests for the second execution environment. For example, top-model PIL.
- Use `cgv.CGV.run` to run the tests for the second execution environment.
- Use `cgv.CGV.getOutputData` to get the output data for each execution environment.
- Use `cgv.CGV.getSavedSignals` to display the signal names in the output data. (optional)
- Build a list of signal names for input to other `cgv.CGV` methods. (optional)
- Use `cgv.CGV.createToleranceFile` to create a file correlating tolerance information with output signal names. (optional)
- Use `cgv.CGV.compare` to compare the output signals of the first and second execution environments for numerical equivalence.

Verify Numerical Equivalence Between Two Modes of Execution of a Model

The following example describes configuring, executing, and comparing the results of the `rtwdemo_cgv` model in simulation and SIL modes.

This example contains the following tasks:

- “Configure the Model” on page 31-87
- “Execute the Model” on page 31-88
- “Compare All Output Signals” on page 31-89
- “Compare Individual Output Signals” on page 31-92

Configure the Model

The first task for verifying numerical equivalence is to check the configuration of your model.

- 1 Open the `rtwdemo_cgv` model.

```
cgvModel = 'rtwdemo_cgv';
load_system(cgvModel);
```

- 2 Save the model to a working directory.

```
save_system(cgvModel, fullfile(pwd, cgvModel));
close_system(cgvModel); % avoid original model shadowing saved model
```

- 3 Use the `cgv.Config` to create a `cgv.Config` object. Specify parameters that check and modify configuration parameter values and save the model for top-model SIL mode of execution.

```
cgvCfg = cgv.Config('rtwdemo_cgv', 'connectivity', 'sil', 'SaveModel', 'on');
```

- 4 Use the `cgv.Config.configModel` method to review your model configuration and to change the settings to configure your model for SIL. When 'connectivity' is set to 'sil', the system target file is automatically set to 'ert.tlc'. If you specified the parameter/value pair, ('SaveModel', 'on') when you created the `cgvCfg` object, the `cgv.Config.configModel` method saves the model.

Note CGV runs on models that are open. If you modify a model without saving it, CGV might issue an error.

```
cgvCfg.configModel(); % Evaluate, change, and save your model for SIL
```

- 5 Display a report of the changes that `cgv.Config.configModel` makes to the model.

```
cgvCfg.displayReport(); % In this example, this reports no changes
```

Execute the Model

Use the CGV API to execute the model in two modes. The two modes in this example are normal mode simulation and SIL mode. In each execution of the model, the CGV object for each mode captures the output data and writes the data to a file.

- 1 If you have not already done so, follow the steps described in “Configure the Model” on page 31-87.
- 2 Create a `cgv.CGV` object that specifies the `rtwdemo_cgv` model in normal mode simulation.

```
cgvSim = cgv.CGV(cgvModel, 'connectivity', 'sim');
```

Note When the top model is set to Normal simulation mode, referenced models set to PIL mode will be changed to Accelerator mode.

- 3 Provide the input file to the `cgvSim` object.

```
cgvSim.addInputData(1, [cgvModel '_data']);
```

- 4 Before execution of the model, specify the MATLAB files to execute or MAT-files to load. This step is optional.

```
cgvSim.addPostLoadFiles({[cgvModel '_init.m']});
```

- 5 Specify a location where the object writes all output data and metadata files for execution. This step is optional.

```
cgvSim.setOutputDir('cgv_output');
```

- 6 Execute the model.

```
result1 = cgvSim.run();

*** handling PostLoad file rtwdemo_cgv_init.m
Start CGV execution of model rtwdemo_cgv, ComponentType topmodel, ...
  connectivity sim, InputData rtwdemo_cgv_data.mat
End CGV execution: status completed
```

- 7 Get the output data associated with the input data.

```
outputDataSim = cgvsim.getOutputData(1);
```

- 8 For the next mode of execution, SIL, repeat steps 2–7.

```
cgvsil = cgvsim.CGV( cgvsimModel, 'Connectivity', 'sil');
cgvsil.addInputData(1, [cgvsimModel '_data']);
cgvsil.addPostLoadFiles({'_init.m'});
cgvsil.setOutputDir('cgvsim_output');
result2 = cgvsil.run();
```

At the MATLAB command line, the result is:

```
*** handling PostLoad file rtwdemo_cgv_init.m
Start CGV execution of model rtwdemo_cgv, ComponentType topmodel, ...
    connectivity sil, InputData rtwdemo_cgv_data.mat

### Starting build procedure for model: rtwdemo_cgv
### Successful completion of build procedure for ...
    model: rtwdemo_cgv
### Preparing to start SIL simulation ...
### Starting SIL simulation for model: rtwdemo_cgv
### Stopping SIL simulation for model: rtwdemo_cgv
End CGV execution: status completed
```

Compare All Output Signals

After setting up and running the test, compare the outputs by doing the following:

- 1 If you have not already done so, configure and test the model, as described in “Configure the Model” on page 31-87 and “Execute the Model” on page 31-88.
- 2 Test that the execution result of the model:

```
if ~result1 || ~result2
    error('Execution of model failed.');
```

end

- 3** Use the `cgv.CGV.getOutputData` method to get the output data from the `cgv.CGV` objects.

```
simData = cgvSim.getOutputData(1);  
silData = cgvSil.getOutputData(1);
```

- 4** Display a list of signals by name using the `cgv.CGV.getSavedSignals` method.

```
cgvSim.getSavedSignals(simData);
```

At the MATLAB command line, the result is:

```
simData.hi0.Data(:,1)  
simData.hi0.Data(:,2)  
simData.Vector.Data(:,1)  
simData.Vector.Data(:,2)  
simData.Vector.Data(:,3)  
simData.Vector.Data(:,4)  
simData.BusOutputs.hi0.Data(:,1)  
simData.BusOutputs.hi0.Data(:,2)  
simData.BusOutputs.hi1.mid0.lo0.Data(1,1,:)   
simData.BusOutputs.hi1.mid0.lo0.Data(1,2,:)   
simData.BusOutputs.hi1.mid0.lo0.Data(2,1,:)   
simData.BusOutputs.hi1.mid0.lo0.Data(2,2,:)   
simData.BusOutputs.hi1.mid0.lo1.Data   
simData.BusOutputs.hi1.mid0.lo2.Data   
simData.BusOutputs.hi1.mid1.Data(:,1)   
simData.BusOutputs.hi1.mid1.Data(:,2)   
simData.ErrorsInjected.Data
```

- 5** Using the list of signals, build a list of signals in a cell array of strings. The signal list can contain a number of signals.

```
signalList = {'simData.ErrorsInjected.Data'};
```

- 6** Use the `cgv.CGV.createToleranceFile` method to create a file, in this example, 'localtol', correlating tolerance information with output signal names.

```
toleranceList = {'absolute', 0.5};
```

```
cgv.CGV.createToleranceFile('localtol', signalList, toleranceList);
```

- 7** Compare the output data signals. By default, the `cgv.CGV.compare` method looks at all signals which have a common name between both executions. If a tolerance file is present, `cgv.CGV.compare` uses the associated tolerance for a specific signal during comparison; otherwise the tolerance is zero. In this example, the 'Plot' parameter is set to 'mismatch'. Therefore, only mismatched signals produce a plot.

```
[matchNames, ~, mismatchNames, ~] = ...
    cgv.CGV.compare(simData, silData, 'Plot', 'mismatch', ...
    'Tolerancefile', 'localtol');
fprintf( '%d Signals match, %d Signals mismatch\n', ...
    length(matchNames), length(mismatchNames));
disp('Mismatched Signal Names:');
disp(mismatchNames);
```

At the MATLAB command line, the result is:

```
14 Signals match, 1 Signals mismatch
Mismatched Signal Names:
    'simData.ErrorsInjected.Data'
```

A plot results from the mismatch on signal `simData.ErrorsInjected.Data`.

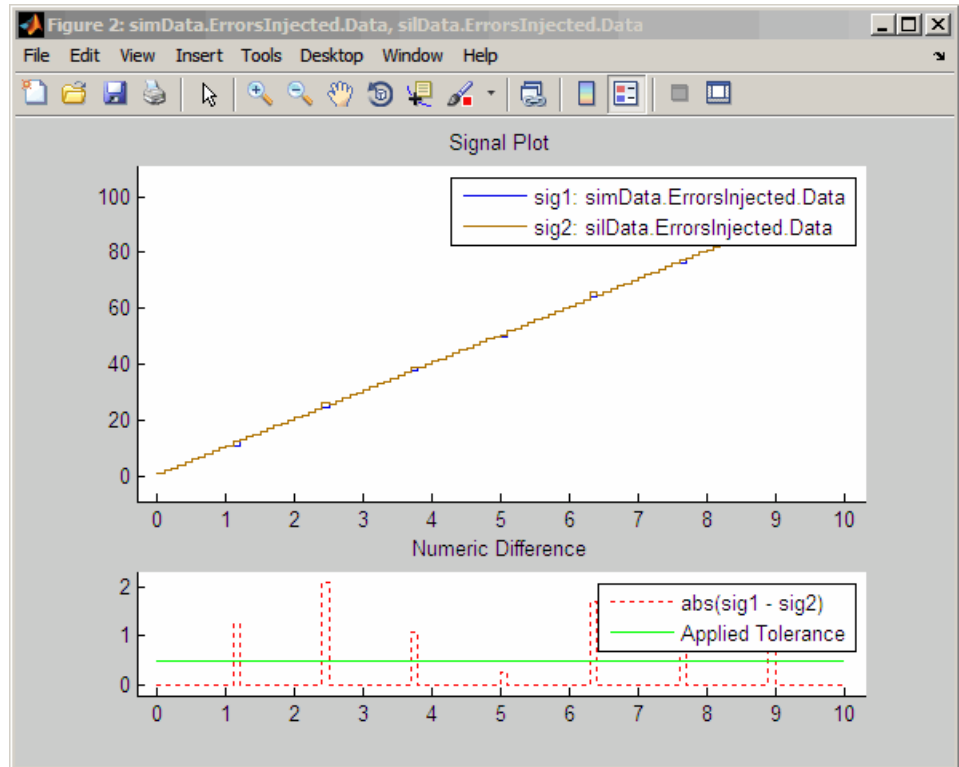

The lower plot displays the numeric difference between the results.

Compare Individual Output Signals

After setting up and running the test, compare the outputs of individual signals by doing the following:

- 1 If you have not already done so, configure and test the model, as described in “Configure the Model” on page 31-87 and “Execute the Model” on page 31-88.
- 2 Use the `cgv.CGV.getOutputData` method to get the output data from the `cgv.CGV` objects.

```
simData = cgvSim.getOutputData(1);
silData = cgvSi1.getOutputData(1);
```

- 3** Use the `cgv.CGV.getSavedSignals` method to display the output data signal names. Build a list of specific signal names in a cell array of strings. The signal list can contain number of signals.

```
cgv.CGV.getSavedSignals(simData);
signalList = {'simData.BusOutputs.hi1.mid0.lo1.Data', ...
'simData.BusOutputs.hi1.mid0.lo2.Data', 'simData.Vector.Data(:,3)'};
```

- 4** Use the specified signals as input to the `cgv.CGV.compare` method to compare the signals from separate runs.

```
[matchNames, ~, mismatchNames, ~] = ...
    cgv.CGV.compare(simData, silData, 'Plot', 'mismatch', ...
    'signals', signalList);
fprintf( '%d Signals match, %d Signals mismatch\n', ...
    length(matchNames), length(mismatchNames));
if ~isempty(mismatchNames)
    disp( 'Mismatched Signal Names:');
    disp(mismatchNames);
end
```

At the MATLAB command line, the result is:

```
3 Signals match, 0 Signals mismatch
```

Plot Output Signals

After setting up and running the test, use the `cgv.CGV.plot` method to plot output signals.

- 1** If you have not already done so, configure and test the model, as described in “Configure the Model” on page 31-87 and “Execute the Model” on page 31-88.
- 2** Use the `cgv.CGV.getOutputData` method to get the output data from the `cgv.CGV` objects.

```
simData = cgvSim.getOutputData(1);
```

- 3** Use the `cgv.CGV.getSavedSignals` method to display the output data signal names. Build a list of specific signal names in a cell array of strings. The signal list can contain number of signals.

```
cgv.CGV.getSavedSignals(simData);  
signalList = {'simData.Vector.Data(:,1)'};
```

- 4 Use the specified signal list as input to the `cgv.CGV.plot` method to compare the signals from separate runs.

```
[signalNames, signalFigures] = cgv.CGV.plot(simData, ...  
    'Signals', {'simData.Vector.Data(:,1)'});
```

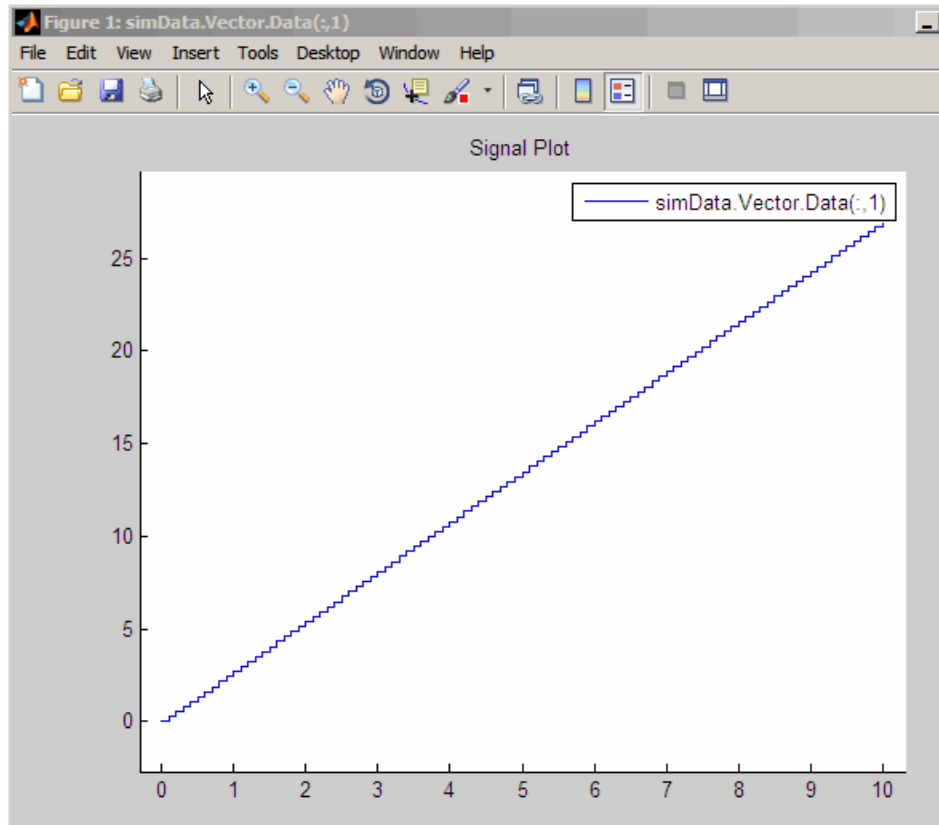

Code Coverage

- “Code Coverage in SIL and PIL Simulations” on page 32-2
- “Configure Code Coverage Programmatically” on page 32-7
- “Code Coverage for PIL” on page 32-9
- “Code Coverage Summary and Annotations” on page 32-11
- “Code Coverage Tool Support” on page 32-17
- “Tips and Limitations” on page 32-18

Code Coverage in SIL and PIL Simulations

In this section...

“Configure SIL and PIL Code Coverage” on page 32-2

“View Code Coverage Information at the End of SIL or PIL Simulations” on page 32-4

Configure SIL and PIL Code Coverage

During a top-model or Model block SIL or PIL simulation, you can collect code coverage metrics for generated code using a third-party tool. Embedded Coder supports the following tools:

- LDRA Testbed® from LDRA Software Technology. For information about installing and using this tool, go to www.ldra.com.

The software supports LDRA Testbed code coverage for SIL and PIL. For information about PIL support, see “PIL Support for LDRA Testbed” on page 32-9.

- BullseyeCoverage™ from Bullseye Testing Technology™. For information about installing and using this tool, go to www.bullseye.com/cgi-bin/mwEval.

The software supports BullseyeCoverage code coverage for SIL and, in certain cases, PIL. For information about PIL support, see “PIL Support for BullseyeCoverage” on page 32-10.

See “Code Coverage Tool Support” on page 32-17.

To configure a code coverage tool for a top-model or Model block SIL or PIL simulation:

- 1 Select **Simulation > Model Configuration Parameters > Code Generation > Verification**.
- 2 From the **Code coverage tool** drop-down list, select a tool, for example, BullseyeCoverage or LDRA Testbed.
- 3 Click **Configure Coverage** to open the Code Coverage Settings dialog box.

- 4** In the **Installation folder** field, specify the location where your coverage tool is installed. If you click **Browse**, the Browse for Folder dialog box opens, which allows you to navigate to the folder where your coverage tool is installed. The software detects and displays the tool version.

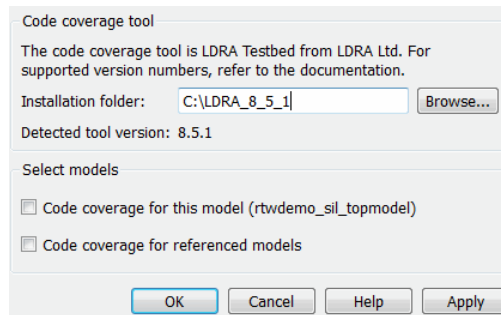

- 5** Specify the models for which you want code coverage data:
- To generate coverage data for just the current (top) model, select the **Code coverage for this model** check box.
 - To generate data for models referenced by the current (top) model, select the **Code coverage for referenced models** check box.

Note If you do not select a check box, the software does *not* generate code coverage data.

- 6** Click **OK**. You return to the **Verification** pane.
- 7** To view cumulative code coverage results within a code generation report, in the **Configuration Parameters > Code Generation > Report** pane, select the following check boxes:
- **Create code generation report**
 - **Launch report automatically**
- 8** Click **OK**. You return to the model window.

To examine the generated code coverage information, see “View Code Coverage Information at the End of SIL or PIL Simulations” on page 32-4.

With LDRA Testbed:

- The evaluation of cumulative code coverage begins from the point when you last added a new file to the existing set of source files. For example, existing code coverage results will be deleted when you:
 - Run a simulation with a new model using the existing code generation folder
 - Run a simulation that results in additional source code files being instrumented
- If you switch between SIL and PIL simulations of a model, the software generates separate cumulative code coverage results for the SIL and PIL simulations.

For an example of collecting code coverage metrics, see `rtwdemo_code_coverage_script`.

View Code Coverage Information at the End of SIL or PIL Simulations

When the SIL or PIL simulation is complete, the code generation report opens automatically and you see hyperlinks in the Command Window.

If you specified the LDRA Testbed, you see three links in the Command Window:

```
### Starting SIL simulation for component: rtwdemo_sil_topmodel
### Stopping SIL simulation for component: rtwdemo_sil_topmodel
### Starting analysis of coverage data
### Use the following links to view code coverage results:
    LDRA Testbed GUI
    LDRA Testbed Code Coverage Overview Report
    HTML code generation report with code coverage annotations
### Completed code coverage analysis
>>
```

To:

- Go to the LDRA Testbed GUI, click the first link.
- Open the LDRA Testbed Report with your Web browser, click the second link.

LDRA Testbed ® Dynamic Overview Report

Set : work3_3afef0b64dc51060

Report Production	Report Configuration
<ul style="list-style-type: none"> • C/C++ LDRA Testbed Version: 8.5.1 	<ul style="list-style-type: none"> • DO-178B Level: 'a' • Report Format: Procedure Listing • Procedure Sort Method: Source File order • Reporting Scope: Source file and associated header

Contents

Combined Coverage for Selected Metrics

- Statement
- Branch/Decision
- Modified Condition/ Decision

[Table of Coverage Metric Pass Levels](#)
[Key to Terms](#)

For information about using this report, refer to the LDRA Testbed documentation.

- View summary data and code annotations with coverage information in the code generation report, click the third link. See “Code Coverage Summary and Annotations” on page 32-11.

If you specified the BullseyeCoverage tool, you see two links in the Command Window:

```
### Starting SIL simulation for component: rtwdemo_sil_topmodel
### Stopping SIL simulation for component: rtwdemo_sil_topmodel
### Processing code coverage data
### Use the following links to view code coverage results:
    BullseyeCoverage browser (coverage for last run)
    HTML code generation report (cumulative coverage)
### Completed code coverage analysis
>>
```

To :

- View the coverage report using the BullseyeCoverage Browser, click the first link.

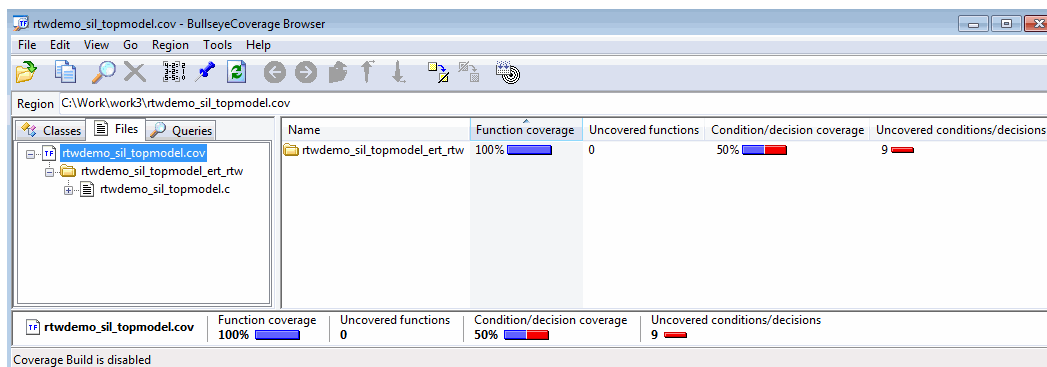

The BullseyeCoverage Browser shows coverage data for instrumented files associated with your latest top-model simulation. The coverage data shown in the browser is not cumulative and pertains only to the most recent simulation. For information about the BullseyeCoverage Browser, go to www.bullseye.com.

- View summary data and code annotations with coverage information in the code generation report, click the second link. See “Code Coverage Summary and Annotations” on page 32-11.

Configure Code Coverage Programmatically

You can configure code coverage for your model using command line APIs. A typical workflow with BullseyeCoverage is:

- 1 Using `get_param`, retrieve the object containing coverage settings for the current model, for example, `gcs`.

```
>> covSettings = get_param(gcs, 'CodeCoverageSettings')

covSettings =

  cov.CodeCoverageSettings handle
  Package: cov

  Properties:
    TopModelCoverage: 'on'
    ReferencedModelCoverage: 'off'
    CoverageTool: 'BullseyeCoverage'

  Methods, Events, Superclasses
```

The property `TopModelCoverage` determines whether the software generates code coverage data for just the top model, while `ReferencedModelCoverage` determines whether the software generates coverage data for models referenced by the top model. If neither property is 'on', then no code coverage data is generated during a SIL simulation.

If LDRA Testbed is the specified code coverage tool, then the property `CoverageTool` is 'LDRA Testbed'.

When you save your model, the properties `TopModelCoverage`, `ReferencedModelCoverage`, and `CoverageTool` are also saved.

- 2 Check the class of `covSettings`.

```
>> class(covSettings)

ans =

  cov.CodeCoverageSettings
```

3 Turn on coverage for referenced models.

```
>> covSettings.ReferencedModelCoverage='on';
```

4 Using `set_param`, apply the new coverage settings to the model.

```
>>set_param(gcs,'CodeCoverageSettings', covSettings);
```

5 Assuming you have installed the BullseyeCoverage tool, specify the installation path.

```
>> cov.BullseyeCoverage.setPath('C:\Program Files\BullseyeCoverage')
```

For LDRA Testbed, use `cov.LDRA.setPath('C:\...')`.

6 Check that the path is saved as a preference.

```
>> cov.BullseyeCoverage.getPath
```

For LDRA Testbed, use `cov.LDRA.getPath`.

Code Coverage for PIL

PIL Support for LDRA Testbed

The target connectivity API supports code coverage with LDRA Testbed for top-model and Model block PIL.

For LDRA Testbed version 8.5.1, you must manually add MathWorks instrumentation files to the LDRA Testbed installation folder, for example:

- C:\LDRA_Toolsuite\Compiler_spec\MathWorks\MathWorks_Cinstr.DAT
- C:\LDRA_Toolsuite\Compiler_spec\MathWorks\MathWorks_CPPINSTR.DAT

These files may be available in future versions of LDRA Testbed.

There are minor differences in the code coverage information collected during SIL and PIL simulations. In particular, with PIL, the software does not explicitly show function exit point coverage. However, you can infer the coverage of function exit points by examining statement coverage.

```
File: rtwdemo\_sil\_topmodel.c
LDRA Testbed code coverage enabled
Function exit points: 100%
Branch/decision: 57%
Statement: 87%
MC/DC: 0%
Branch/condition: 37%
```

```

1 /*
2  * File: rtwdemo_sil_topmodel.c
3  *
```

SIL

```
File: rtwdemo\_sil\_topmodel.c
LDRA Testbed code coverage enabled
Statement: 87%
MC/DC: 0%
Branch/condition: 37%
Branch/decision: 57%
```

```

1 /*
2  * File: rtwdemo_sil_topmodel.c
3  *
```

PIL

PIL Support for BullseyeCoverage

Code coverage with BullseyeCoverage is available for top-model and Model block PIL provided your PIL application can write directly to the host file system. Your target for the PIL application must provide `fopen` and `fread` access to the host file system.

If code coverage is not available when you run the PIL application on your target hardware, you might be able to collect code coverage measurements by running the PIL application on an instruction set simulator that supports direct file I/O with the host file system.

Code Coverage Summary and Annotations

If you specify a code coverage tool for a SIL or PIL simulation (see “Code Coverage in SIL and PIL Simulations” on page 32-2), the software produces a code generation report that provides summary data and code annotations with coverage information. Each code annotation is associated with a code feature and indicates the nature of the feature coverage during code execution. For more information, see:

- “LDRA Testbed Coverage” on page 32-11
- “BullseyeCoverage Information” on page 32-14

The code generation report also allows you to navigate easily between blocks in your model and the corresponding sections in the source code. For more information, see “Trace Model Objects to Generated Code” on page 28-6 and “Trace Code to Model Objects Using Hyperlinks” on page 28-4.

LDRA Testbed Coverage

The cumulative coverage data in a code generation report is derived from instrumented files associated with your latest top-model simulation **and** coverage data collected from simulations with other top models that share referenced models with your current top model.

The screenshot displays a code generation report for the file `rtwdemo_sil_topmodel.c`. The report includes a navigation pane on the left with sections for Contents, Generated Files, and Interface files. The main content area shows the source code with coverage annotations. The coverage data is summarized as follows:

Metric	Value
Function exit points	100%
Statement	87%
Branch/condition	37%
Branch/decision	57%
MC/DC	0%

The source code annotations include the following information:

```

1  /*
2  * File: rtwdemo_sil_topmodel.c
3  *
4  * Code generated for Simulink model 'rtwdemo_sil_topmodel'.
5  *
6  * Model version          : 1.206
7  * Simulink Coder version : 8.2 (R2012a) 07-Oct-2011
8  * TLC version           : 8.2 (Oct 7 2011)
9  * C/C++ source code generated on : Wed Oct 19 12:29:12 2011
10 *
11 * Target selection: ert.tlc
12 * Embedded hardware selection: Specified
13 * Code generation objectives: Unspecified
14 * Validation result: Not run
15 */
16
17 #include "rtwdemo_sil_topmodel.h"
18
19 /* Block signals and states (auto storage) */
20 D_HorX rtDWork;
21

```

The software provides LDRA Testbed annotations in the code generation report to help you to review code coverage.

Note Do not use the code generation report alone to verify that you have achieved your coverage goals. You must refer to the LDRA Testbed Report. See “View Code Coverage Information at the End of SIL or PIL Simulations” on page 32-4.

This example shows three kinds of annotations. On lines 134, 139, 140, and 141, the annotation **■** indicates that statement coverage for each of these lines of code is not complete.

```

■ 134 if (x10Work.bitsForT1D0.LogicalOperator1) {
=>b .....^
135 /* Switch: 'cS2>/Switch1' incorporates:
136 * Constant: 'cS2>/C1'
137 * Import: 'cRoot>/reset'
138 */
■ 139 if (x10.reset) {
=> .....^
140 x10Work.PreviousOutput_DSTATE = 00;
■ 141 }

```

Placing the cursor over the annotation **=>b** produces a tooltip.

```

■ 134 if (x10Work.bitsForT1D0.LogicalOperator1) {
=>b .....^
Branch destinations
covered
<line><<column>: 158c3
branch destinations not
covered: 134c45
Switch: 'cS2>/Switch1' incorporates:
Constant: 'cS2>/C1'
Import: 'cRoot>/reset'
}

```

This tooltip indicates that only one branch destination is covered. The code within the curly brackets, which starts at column 45 of line 134, is not executed. As the `if` statement on line 139 lies within this code, the corresponding annotation **=>** states that the branch is not covered.

The following table describes the LDRA Testbed code annotations that you might see in a code generation report produced by a SIL and PIL simulations.

Code feature	Annotation symbol	What happened during simulation
Function	Fcn	Function <i>name</i> returned through this exit point.
	=>	Function <i>name</i> never returned through this exit point.
Branch/condition	=>	Condition not encountered.
	=>t	Condition evaluated true only.
	=>f	Condition evaluated false only.
	tf	Condition evaluated both true and false.
Branch/decision	=>	Branch never encountered.
	=>b	Branch to at least one destination covered and branch to at least one other destination not covered.
	b	Branch fully exercised.
Modified Condition/Decision Coverage (MC/DC)	=>mc	Condition did not independently affect outcome of decision .
	mc	Condition independently affected outcome of decision.
Statement	▪	Statements associated with line covered.
	▪	Not all statements associated with line covered.

Code feature	Annotation symbol	What happened during simulation
Code that is reformatted by LDRA Testbed and does not match the original source code. For example, source code with <code>#include</code> statements to include other files, and source code with <code>#define</code> statements for macros. For detailed coverage information, refer to the LDRA Testbed report.	$\Rightarrow\Sigma$	Zero coverage — probes within source code line or files included by source code line not exercised.
	$\Rightarrow\Sigma$	Coverage probes within source code line or any included file partially exercised.
	Σ	Coverage probes within source code line or included files fully exercised.

Bullseye Coverage Information

The cumulative coverage data in a code generation report is derived from instrumented files associated with your latest top-model simulation **and** coverage data collected from simulations with other top models that share referenced models with your current top model.

File: `rtwdemo_sil_topmodel.c`

BullseyeCoverage code coverage enabled

Function: 100% Condition/decision: 50%

```

1  /*
2  * File: rtwdemo_sil_topmodel.c
3  *
4  * Code generated for Simulink model 'rtwdemo_sil_topmodel'.
5  *
6  * Model version          : 1.205
7  * Simulink Coder version : 8.2 (R2012a)
8  * TLC version            : 8.2 (Oct 7 2011)
9  * C/C++ source code generated on : Tue Oct 10 11:33:01 2011
10 *
11 * Target selection: ert.tlc
12 * Embedded hardware selection: Specified
13 * Code generation objectives: Unspecified
14 * Validation result: Not run
15 *
16 #include "rtwdemo_sil_topmodel.h"
17
18 /* Block signals and states (auto storage) */
19 #_Work rtWork;
20
21 /* External inputs (root input signals with auto storage) */

```

The software provides BullseyeCoverage annotations in the code generation report to help you to review code coverage.

This example shows two kinds of annotations. At line 41, **TF** indicates that the `if` decision had both true and false outcomes during the simulation. At line 52, **=>F** indicates that the `if` decision was false only during the simulation.

```

TF 41  if (rtU.reset) {
42      rtDWork.PreviousOutput_DSTATE = 20U;
43  }
44
45  /* Switch: '<Root>/Switch' incorporates:
46   * Constant: '<Root>/c1'
47   * Constant: '<Root>/c3'
48   * Input: '<Root>/ ticks_to_count'
49   * RelationalOperator: '<Root>/upper GE input'
50   * Sum: '<Root>/Add'
51  */
=>F 52  if ((uint8_T)((uint32_T)rtU.ticks_to_count + (uint32
53      rtDWork.PreviousOutput_DSTATE) == 40)

```

The following table describes the BullseyeCoverage code annotations that you might see in a code generation report produced by a SIL simulation.

Code feature	Annotation symbol	What happened during simulation
Decision	=>	Decision not executed.
	TF	Decision evaluated both true and false.
	=>T	Decision evaluated true only.
	=>F	Decision evaluated false only.

Code feature	Annotation symbol	What happened during simulation
Function	=>	Function not called.
	Fcn	Function called.
Switch label	=>	Switch command not used.
	Sw	Switch command used.
Constant	k	Decision or condition was constant, which did not allow any variation in coverage.
Condition	=>	Condition not encountered.
	tf	Condition evaluated both true and false.
	=>t	Condition evaluated true only.
	=>f	Condition evaluated false only.
Try	=>	Try block never completed.
	Try	Try block covered.
Catch	=>	Catch block not covered.
	Cat	Catch block covered.

Code Coverage Tool Support

Embedded Coder is tested with the following versions of the BullseyeCoverage and LDRA Testbed tools.

Note

- BullseyeCoverage is supported on 64-bit Linux only.
- BullseyeCoverage support is not tested on the 64-bit Macintosh operating system.

Operating system	BullseyeCoverage	LDRA Testbed
Windows	8.4.23	8.5.1
Linux	8.4.19	Not supported

Tips and Limitations

Compiler and Platform Support for SIL

For SIL code coverage, the software supports the following compilers and platforms:

- On a Linux platform, gcc
- On a Windows platform, Microsoft Visual C++ (MSVC)

Note For both SIL and PIL, the Watcom compiler is not supported. If you specify this compiler, an error appears when you build your model.

For information on how to specify a compiler, see “Choose and Configure a Compiler” in the Simulink Coder documentation.

Right-Click Subsystem Build Unsupported for Code Coverage

The software does not support right-click builds for subsystems if a code coverage tool is specified.

BullseyeCoverage License Wait

When you build your model, you might have to wait for a BullseyeCoverage license. If you want to see information about the wait, before you build your model, select **Code Generation > Debug > Verbose build**.

Current Working Folder Cannot be UNC Path

If your MATLAB current working folder is a Universal Naming Convention (UNC) path, code coverage fails.

Characters in matlabroot and File Path

If `matlabroot` or the path to your generated files contains a space or the . (period) character, code coverage might fail.

Header Files with Identical Names

Consider a model that is configured for LDRA Testbed code coverage. During the build process, if the software detects two header files with the same name in the folder for generated code, the software generates an error.

Code Coverage for Source Files in Shared Utility Folders

The software supports code coverage for source files generated in shared utility folders. If you configure code coverage for a model that uses shared utility code generation, when you build the model, you also build all source files in the shared utilities folder with code coverage enabled.

Whenever you build a model, the code coverage settings of the model must be consistent with source files that you previously built in the shared utilities folder. Otherwise, the software reports that code in the shared utilities folder is inconsistent with the current model configuration and must be rebuilt. For example, if you run a SIL simulation for a model with code coverage enabled and then run a SIL simulation for another model with code coverage disabled, the software must rebuild all source files in the shared utilities folder.

BullseyeCoverage Behavior with Inline Macros

The BullseyeCoverage tool, by default, does not provide code coverage data for inline macros.

For example, if a model generates a file `slprj/ert/_sharedutils/rt_SATURATE.h` that contains the macro

```
#define rt_SATURATE(sig,ll,u1) (((sig) >= (u1)) ? (u1) :  
(((sig) <= (ll)) ? (ll) : (sig)) )
```

and the macro is in `sat_ert_rtw/sat.c`, then the coverage report provides a measurement for `sat.c`, but no coverage data for the conditions within the macro `rt_SATURATE`.

To configure the BullseyeCoverage tool to provide code coverage data for inline macros:

- 1 Open the BullseyeCoverage Browser.
- 2 Select **Tools > Options** to open the Options dialog box.
- 3 On the **Build** tab, select the **Instrument macro expansions** check box.
- 4 Click **OK**.
- 5 Rerun your simulation.

Alternatively, you can add the text `-macro` to the BullseyeCoverage configuration file. For more information, go to www.bullseye.com/help/ref_covc.html.

SIL and PIL Simulations with Open LDRA Testbed

If you enable code coverage with the LDRA Testbed tool, you must verify that the LDRA Testbed GUI is not open when you run your SIL or PIL simulation. If the set name in the LDRA Testbed GUI differs from the set name used by the SIL or PIL simulation, the SIL or PIL simulation fails.

PIL Zero Coverage LDRA Testbed Annotations

For a PIL simulation with LDRA Testbed code coverage specified, there might be some source files where the recorded coverage is zero. In this case, the software provides summary information indicating that:

- There is coverage to measure.
- The coverage is zero.

You do not see information for individual probes on each line. The displayed summary information has an associated annotation tooltip:

0 out of *N* coverage probes were exercised (detailed breakdown unavailable)

Modify Legacy Code

If you modify legacy code and rerun a SIL or PIL simulation, the legacy code will be recompiled. However, the code from the model may be up-to-date. In this case, the code generation report is not updated and does not show the modified legacy code. Instead, the code coverage information for the modified

legacy code is displayed with reference to the original legacy code. You must regenerate the report. For more information, see “Limitation”.

Code Execution Profiling

- “About Code Execution Profiling” on page 33-2
- “Configure Code Execution Profiling” on page 33-3
- “Execution Profiling for Atomic Subsystems and Model Reference Hierarchies” on page 33-5
- “View and Compare Code Execution Times” on page 33-7
- “Analyze Code Execution Data” on page 33-14
- “Tips and Limitations” on page 33-16

About Code Execution Profiling

Use code execution profiling to obtain a profile of execution times for tasks and functions in your generated code. The software calculates execution times from data that is obtained through instrumentation probes added to the SIL or PIL test harness or placed inside generated code.

Note Tasks are main entry points into the generated code. For example, the step function for a sample rate or the `model_initialize` function.

During a SIL or PIL simulation, you can collect execution time measurements in a specified base workspace variable. See “Configure Code Execution Profiling” on page 33-3.

At the end of the simulation, you can:

- View a report of code execution times
- Use the Simulation Data Inspector to view and compare plots of function execution times
- Analyze the measurements within the MATLAB environment

See “View and Compare Code Execution Times” on page 33-7 and “Analyze Code Execution Data” on page 33-14.

Note The software supports code execution profiling for all types of SIL and PIL simulations, with the exception of *SIL block* simulations.

Configure Code Execution Profiling

To configure code execution profiling for a SIL or PIL simulation:

- 1 In your top model, open the Configuration Parameters dialog box, and select the **Code Generation > Verification** pane.
- 2 Select the **Measure task execution time** check box.
- 3 If you also want function execution times, select the **Measure function execution times** check box. For information about how you apply this setting to atomic subsystems and model reference hierarchies, see “Execution Profiling for Atomic Subsystems and Model Reference Hierarchies” on page 33-5.

Note This feature does not support state functions or MATLAB functions from the Stateflow product.

- 4 In the **Workspace variable** field, specify a name. When you run the simulation, the software generates a variable with this name. The variable contains the execution time measurements, and is an object of type `coder.profile.ExecutionTime`.
- 5 From the **Save options** drop-down list, select one of the following:
 - **Summary data only** — If you want to generate only a report and seek to reduce the use of memory, for example, during a long simulation. See “View and Compare Code Execution Times” on page 33-7.
 - **All measurement and analysis data** — Allows you to generate a report and store execution time profiles in the base workspace. After the simulation, you can use methods from the `coder.profile.ExecutionTime` and `coder.profile.ExecutionTimeSection` classes to retrieve execution time measurements for every call to each profiled section of code that occurs during the simulation. See “Analyze Code Execution Data” on page 33-14.

6 Click **OK**.

For a PIL simulation, you must configure a hardware-specific timer. When you set up the connectivity configuration for your target, create a timer object. See “Create a Connectivity Configuration for a Target” on page 31-40. This action is not required for a SIL simulation.

If you select **All measurement and analysis data** from the **Save options** drop-down list, the software imports simulation results into the Simulation Data Inspector, allowing you to plot execution times and manage and compare plots from various simulations. On the generated report, click any Simulation Data Inspector icon . See “View and Compare Code Execution Times” on page 33-7.

For details about automatically importing simulation data into the Simulation Data Inspector, see “Validate System Behavior”.

Execution Profiling for Atomic Subsystems and Model Reference Hierarchies

To generate execution data for tasks only, on the **Code Generation > Verification** pane of the Configuration Parameters dialog box, select the **Measure task execution time** check box and clear the **Measure function execution times** check box.

To generate function execution data for atomic subsystems in the top model, on the **Code Generation > Verification** pane, you must select the **Measure task execution time** and **Measure function execution times** check boxes.

Note The generation of function execution data requires the insertion of measurement probes into the generated code. The software inserts measurement probes for an atomic subsystem only if you set the **Function packaging** field (on the **Code Generation** tab of the Function Block Parameters dialog box) to either **Nonreusable function** or **Reusable function**. If the field is set to **Auto**, then the insertion of probes depends on the packaging choice that results from the **Auto** setting. If the field is set to **Inline**, the software does not insert probes.

You might not want to generate profiles for specific subsystems. To disable code execution profiling for a subsystem in the top model:

- 1 Right-click the subsystem.
- 2 From the context menu, select **Properties**.
- 3 In the Block Properties dialog box, select the **General** tab.
- 4 In the **Tag** field, enter `DoNotProfile`.
- 5 Click **OK**.

To generate function execution data for model reference hierarchies:

- 1 In the top model, open the Configuration Parameters dialog box, and select the **Code Generation > Verification** pane.

- 2** Select the **Measure task execution time** check box.
- 3** For each Model block that you want to profile, select **Measure function execution times** only at the reference level for which you require function execution data.

For example, consider a top model that has Model block A, which in turn contains Model block B.

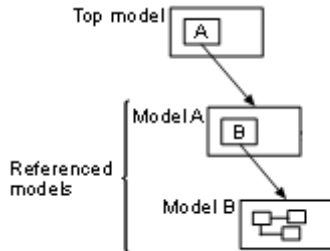

If you want to generate execution times for functions from model B, you must select **Measure task execution time** for the top model and **Measure function execution times** for model B.

If your top model has a PIL block, the execution profiling settings that apply to the PIL block are the settings from the original model that you used to create the PIL block. See “Use a SIL or PIL Block” on page 31-19. The execution profiling settings of your top model do not apply to the PIL block.

View and Compare Code Execution Times

After a SIL or PIL simulation, you can:

- View reports using the `report` method from the `coder.profile.ExecutionTime` class.
- Use the Simulation Data Inspector to:
 - Plot execution times.
 - Manage and compare plots from various simulations.

Consider the model `rtwdemo_sil_topmodel`, which has two subsystems `CounterTypeA` and `CounterTypeB`.

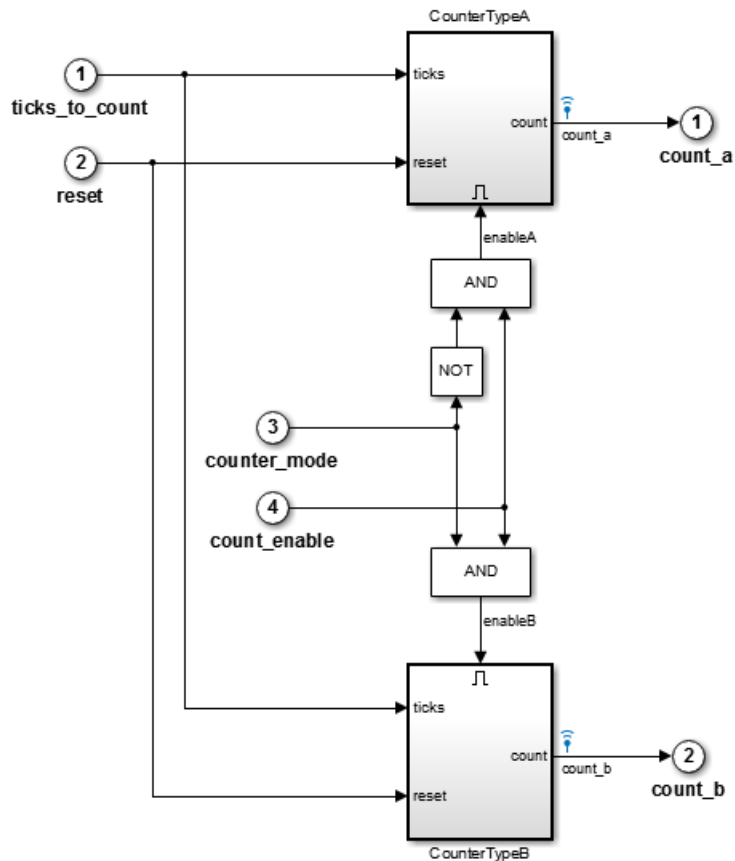

To generate code execution times for the subsystems, specify the following profiling options and run a SIL simulation.

To generate code execution times for the subsystems, on the **Configuration Parameters > Code Generation > Verification** pane:

- 1 Select the following check boxes:
 - Measure task execution time

- Measure function execution times
- 2 Specify a **Workspace variable**, for example, `executionProfile`.
 - 3 From the **Save options** drop-down list, select **All measurement and analysis data**.

When you run, for example, a SIL simulation, the software generates the workspace variable `executionProfile`.

To display a code execution report, in the Command Window, enter:

```
>> executionProfile.report
```

A code execution profiling report opens.

Code Execution Profiling Report for rtwdemo_sil_topmodel

The code execution profiling report provides metrics based on data collected from a SIL or PIL simulation. Execution times are calculated from data recorded by instrumentation probes added to the SIL or PIL test harness or inside the code generated for each model. See [Code Execution Profiling](#) for more information.

1. Summary

Total time (seconds × 1e-09)	16001
Measured time display options	('Units', 'Seconds', 'ScaleFactor', '1e-09', 'NumericFormat', '%0.0f')
Timer frequency (ticks per second)	3.06667e+09
Profiling data created	26-Oct-2012 11:35:25

2. Profiled Sections of Code









Model	Code Section Number	Maximum Execution Time	Average Execution Time	Maximum Self Time	Average Self Time	Calls
[+] rtwdemo_sil_topmodel_initialize	1	220	220	56	56	1
[+] rtwdemo_sil_topmodel_step [0.1 0]	6	400	156	195	97	101

OK Help

Part 1 provides a summary. Part 2 contains information about profiled code sections.

You can expand and collapse profiled sections in Part 2 by clicking [+] and [-] respectively. The following graphic shows fully expanded sections.

2. Profiled Sections of Code

Model	Code Section Number	Maximum Execution Time	Average Execution Time	Maximum Self Time	Average Self Time	Calls	
[-] rtwdemo_sil_topmodel_initialize	1	220	220	56	56	1	
[-] CounterTypeA	2	113	113	98	98	1	
CounterTypeA	3	15	15	15	15	1	
[-] CounterTypeB	4	52	52	38	38	1	
CounterTypeB	5	14	14	14	14	1	
[-] rtwdemo_sil_topmodel_step [0.1 0]	6	400	156	195	97	101	
CounterTypeA	7	148	35	148	35	101	
CounterTypeB	8	60	24	60	24	101	

The report contains time measurements for:

- The model initialization function `rtwdemo_sil_topmodel_initialize`
- A task represented by the step function `rtwdemo_sil_topmodel_step [0.1 0]`
- Functions generated from the subsystems `CounterTypeA` and `CounterTypeB`.

To go to a profiled code section in the Code Generation Report, click the corresponding code section number link. For example, if you click [1](#), you see the measurement probes around the `rtwdemo_sil_topmodel_initialize` call site in the SIL test harness.

```

59 XIL_INTERFACE_ERROR_CODE xilInitialize(uint32_T xilFcnId) {
60     XIL_INTERFACE_ERROR_CODE errorCode = XIL_INTERFACE_SUCCESS;
61     /* initialize output storage owned by In-the-Loop */
62     /* Single In-the-Loop Component */
63     if (xilFcnId == 0) {
64         PROFILE_START_TASK_SECTION(1U);
65         rtwdemo_sil_topmodel_initialize();
66         PROFILE_END_TASK_SECTION(1U);
67     }
68     else {
69         errorCode = XIL_INTERFACE_UNKNOWN_FCNDID;
70     }
71     return errorCode;
72 }

```

By default, the report displays time in nanoseconds (10^{-9} seconds). You can specify the time unit and numeric display format. For example, to display time in microseconds (10^{-6} seconds), use the following command:

```
>>executionProfile.report('Units', 'Seconds', 'ScaleFactor', '1e-06', 'Name')
```

For more information, see report.

The report displays time in seconds only if the timer is calibrated, that is, the number of timer ticks per second is known. On a Windows machine, the software automatically determines this value for a SIL simulation. On a Linux machine, you must manually calibrate the timer. For example, if your processor speed is 1 GHz, specify the number of timer ticks per second:

```
>>executionProfile.TimerTicksPerSecond = 1e9;
```

For more information, see “Analyze Code Execution Data” on page 33-14.

To display measured execution times for a task or function, click the Simulation Data Inspector icon  on the corresponding row. You can use the Simulation Data Inspector to manage and compare plots from various simulations.

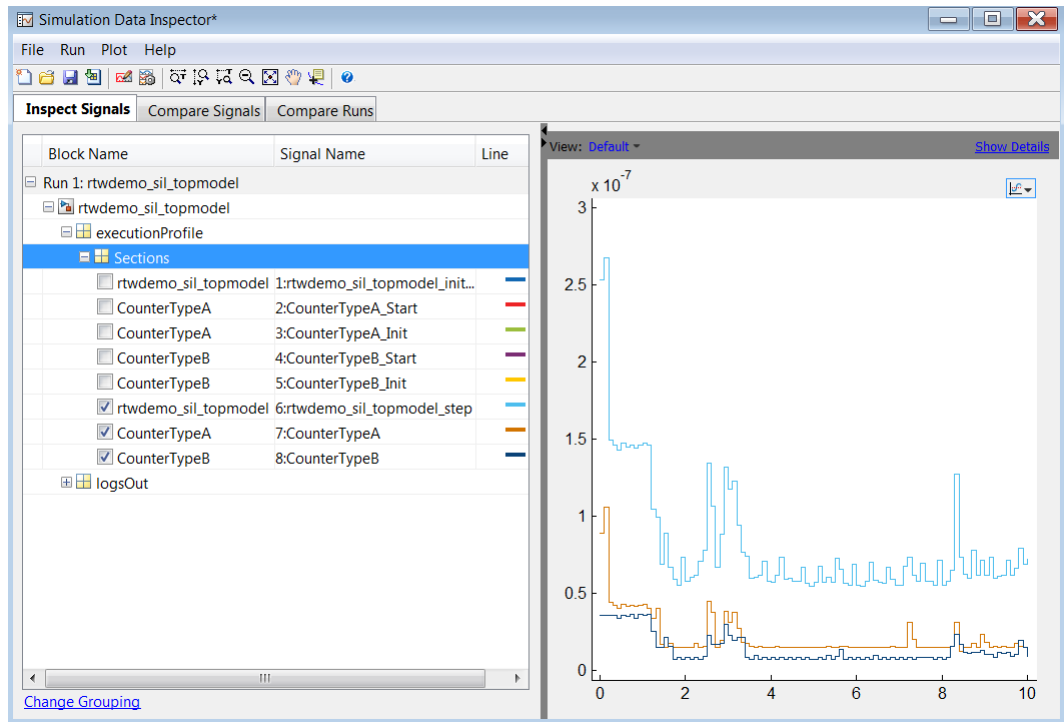

For information, see “Inspect Signal Data with Simulation Data Inspector”.

The following table describes the information provided in the code section profiles.

Column	Description
Model	Name of task, top model, subsystem or Model block. Click the link to go to the model. With a task, the sample period and sample offset are listed next to the name. For example, rtwdemo_sil_topmodel_step [0.1 0] indicates that the sample period is 0.1 seconds and the sample offset is 0.
Code Section Number	Number of profiled code section. Click the link to go to the code section in the Code Generation Report. Code section may be a task or function.

Column	Description
Maximum Execution Time	Maximum time between start and end of function execution. Includes time spent in child functions.
Average Execution Time	Average time between start and end of execution. Includes time spent in child functions.
Maximum Self Time	Longest time spent in function. Excludes time spent in child functions.
Average Self Time	Average time spent in function. Excludes time spent in child functions.
Calls	Number of calls made to task or function.
	Icon that you click to display measured execution times with Simulation Data Inspector. The link works only if the specified workspace variable, for example, <code>executionProfile</code> is present in the base workspace.

Analyze Code Execution Data

After a SIL or PIL simulation, you can analyze execution time data using methods from the `coder.profile.ExecutionTime` and `coder.profile.ExecutionTimeSection` classes.

Consider the model `rtwdemo_sil_topmodel`. Specify the following profiling options and then run a SIL simulation.

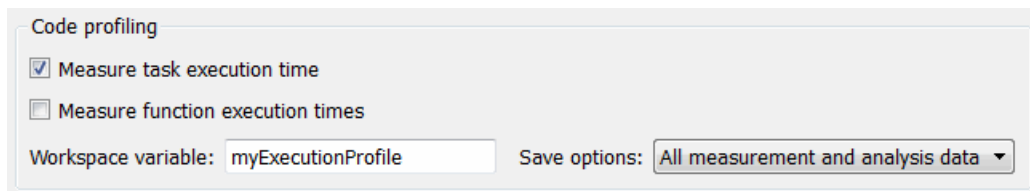

The software generates the workspace variable `myExecutionProfile`, an `coder.profile.ExecutionTime` object.

To get the total number of code sections that have profiling data, use the `Sections` method.

```
>> no_of_Sections = myExecutionProfile.Sections

no_of_Sections =

     2
>>
```

To get the `coder.profile.ExecutionTimeSection` object for a profiled code section, use the method `Sections`.

```
>> FirstSectionProfile = myExecutionProfile.Sections(1)

coder.profile.ExecutionTimeTaskSection

    Section name = rtwdemo_sil_topmodel_initialize
    Sample period = 0
    Sample offset = 0
>>
```

```
>> SecondSectionProfile = myExecutionProfile.Sections(2)
```

```
coder.profile.ExecutionTimeTaskSection
```

```
Section name = rtwdemo_sil_topmodel_step [0.1 0]
```

```
Sample period = 0.1
```

```
Sample offset = 0
```

```
>>
```

Use `coder.profile.ExecutionTimeSection` methods to extract profiling information for a particular code section. For example, use `Name` to obtain the name of a profiled task.

```
>> name_of_section = SecondSectionProfile.Name
```

```
name_of_section =
```

```
rtwdemo_sil_topmodel_step [0.1 0]
```

```
>>
```

To get the sample time associated with the profiled task, use the method `SamplePeriod`.

```
>> sample_time = SecondSectionProfile.SamplePeriod
```

```
sample_time =
```

```
0.1000
```

```
>>
```

If the timer is uncalibrated and you know the timer rate, for example 2.2 GHz, you can use the `coder.profile.ExecutionTime` method `TimerTicksPerSecond` to calibrate the timer:

```
>> myExecutionProfile.TimerTicksPerSecond(2.2e9)
```

```
>> SecondSectionProfile = myExecutionProfile.Sections(2);
```

```
>>
```

Tips and Limitations

Triggered Model Block

Consider the case where a triggered Model block is configured to run in the SIL or PIL simulation mode. The software generates one execution time measurement each time the referenced model is triggered to run. If there are multiple triggers in a single time step, the software generates multiple measurements for the triggered Model block. Conversely, if there is no trigger in a given time step, the software generates no time measurements.

Outliers in Execution Time Profiles

The operating system may preempt a SIL application after the start of a measurement, making the code execution profiling result for the time step unreliable. As a consequence of preemption, you may see outliers in your execution time profiles, with execution times that are longer than expected.

Additionally, for execution time measurements greater than 2^{32} ticks, the counter wraps. Counter wrapping occurs when the actual execution time is very long, which results in a *measured* execution time that is shorter than expected.

Use of Hardware-Specific Timer

If your target configuration does not already specify a timer, you must specify one. To specify a timer, you must create a timer object that provides details of the hardware-specific timer and associated source files. The following limitations apply:

- For SIL simulation, only a 32-bit timer can be used.
- For PIL simulation, you can specify an 8-, 16-, 32- or 64-bit timer. However, only the lower 32-bits of the 64 bit timer are used.

Embedded IDEs and Embedded Targets

- Chapter 34, “Getting Started with Embedded Targets”
- Chapter 35, “Project and Build Configurations for Embedded Targets”
- Chapter 36, “Verification and Profiling Code Generated for Embedded Targets”
- Chapter 37, “Processor-Specific Optimizations for Embedded Targets”
- Chapter 38, “Working with Analog Devices™ VisualDSP++® IDE”
- Chapter 39, “Working with Eclipse IDE”
- Chapter 40, “Working with Green Hills® MULTI® IDE”
- Chapter 41, “Working with Linux Target”
- Chapter 42, “Working with Texas Instruments Code Composer Studio 3.3 IDE”
- Chapter 43, “Working with Texas Instruments Code Composer Studio 4 & 5 IDE”
- Chapter 44, “Working with Texas Instruments C2000 Processors”
- Chapter 45, “Working with Texas Instruments C6000 Processors”
- Chapter 46, “Working with Wind River VxWorks RTOS”
- Chapter 47, “Work with Xilinx® Zynq® Platform”

Getting Started with Embedded Targets

- “Add Support for Hardware and Software” on page 34-2
- “Start Support Package Installer” on page 34-3
- “Open or Reopen Support Package Examples” on page 34-5
- “Install a Support Package on Multiple Computers” on page 34-7

Add Support for Hardware and Software

At the time of publication, you can use Support Package Installer to add support for the following third-party software or hardware to the Embedded Coder product:

- Analog Devices™ DSPs
- Green Hills® MULTI®
- Xilinx® Zynq®-7000 Platform

For detailed information about using Support Package Installer with your hardware, see:

- “Start Support Package Installer” on page 34-3
- “Install Support for Analog Devices DSPs” on page 38-2
- “Install Support for Green Hills® MULTI® IDE” on page 40-2
- “Install Support for Xilinx® Zynq® Platform” on page 47-2

Start Support Package Installer

You can use *Support Package Installer* to install support for specific third-party hardware and software products.

Support Package Installer guides you through the process of downloading and installing a *support package*.

To start Support Package Installer, use one of the following methods:

- In a MATLAB Command Window, enter `targetinstaller`.
- In a model, select **Tools > Run on Target Hardware > Install/Update Support Package**.
- Double-click a `*.mlpkginstall` file.
- On the MATLAB tool strip, click **Add-Ons** and select **Get Hardware Support Packages**.

Show me

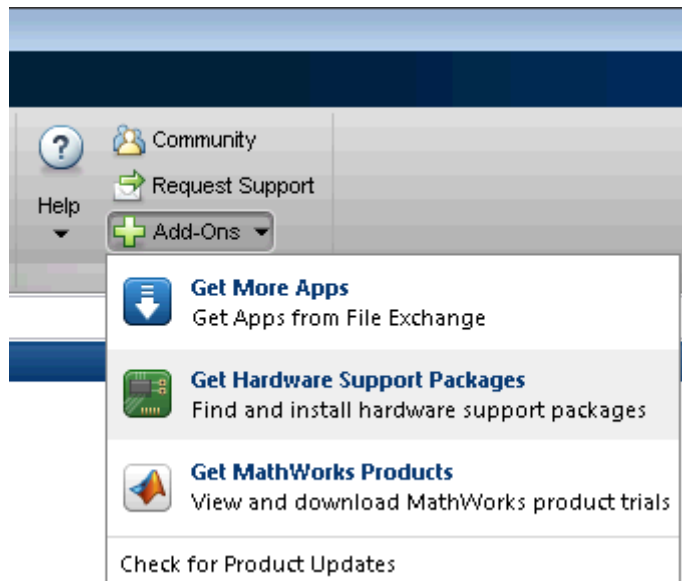

- In Configuration Parameters dialog box, on the Coder Targets pane, under the Target Hardware Resources tab, set the **IDE/Tool Chain** parameter to **Get more...**

Open or Reopen Support Package Examples

To open or reopen support package examples for your target hardware:

- When you use Support Package Installer to install a support package or update the firmware, leave the **Show support package examples** check box on the last pane enabled, and click **Finish**.

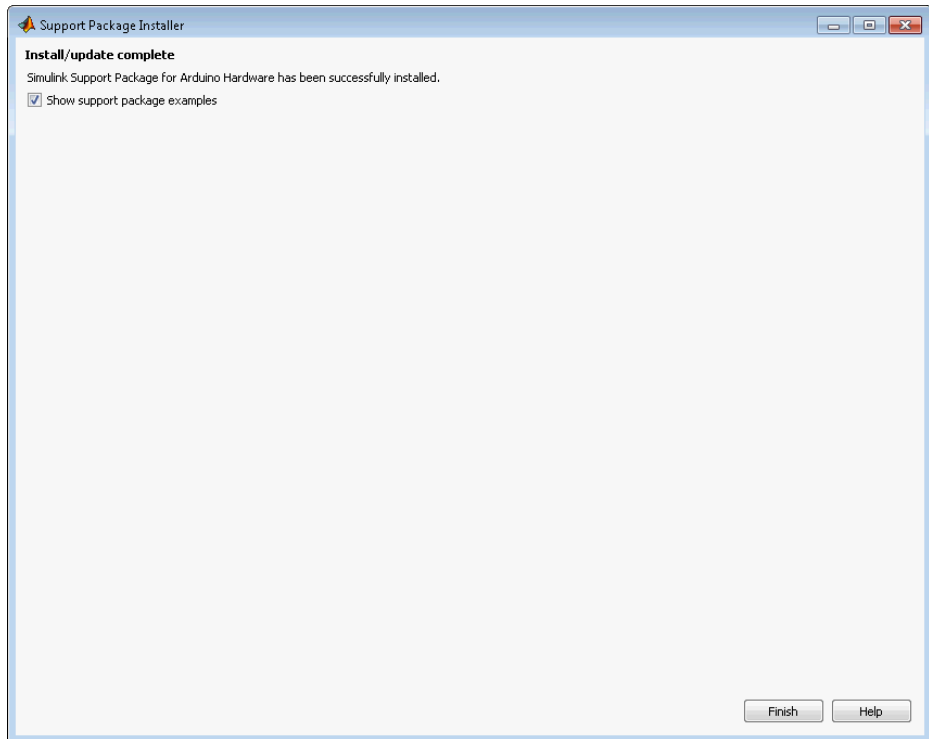

- On the MATLAB Help home page, click the **Supplemental Software** link.

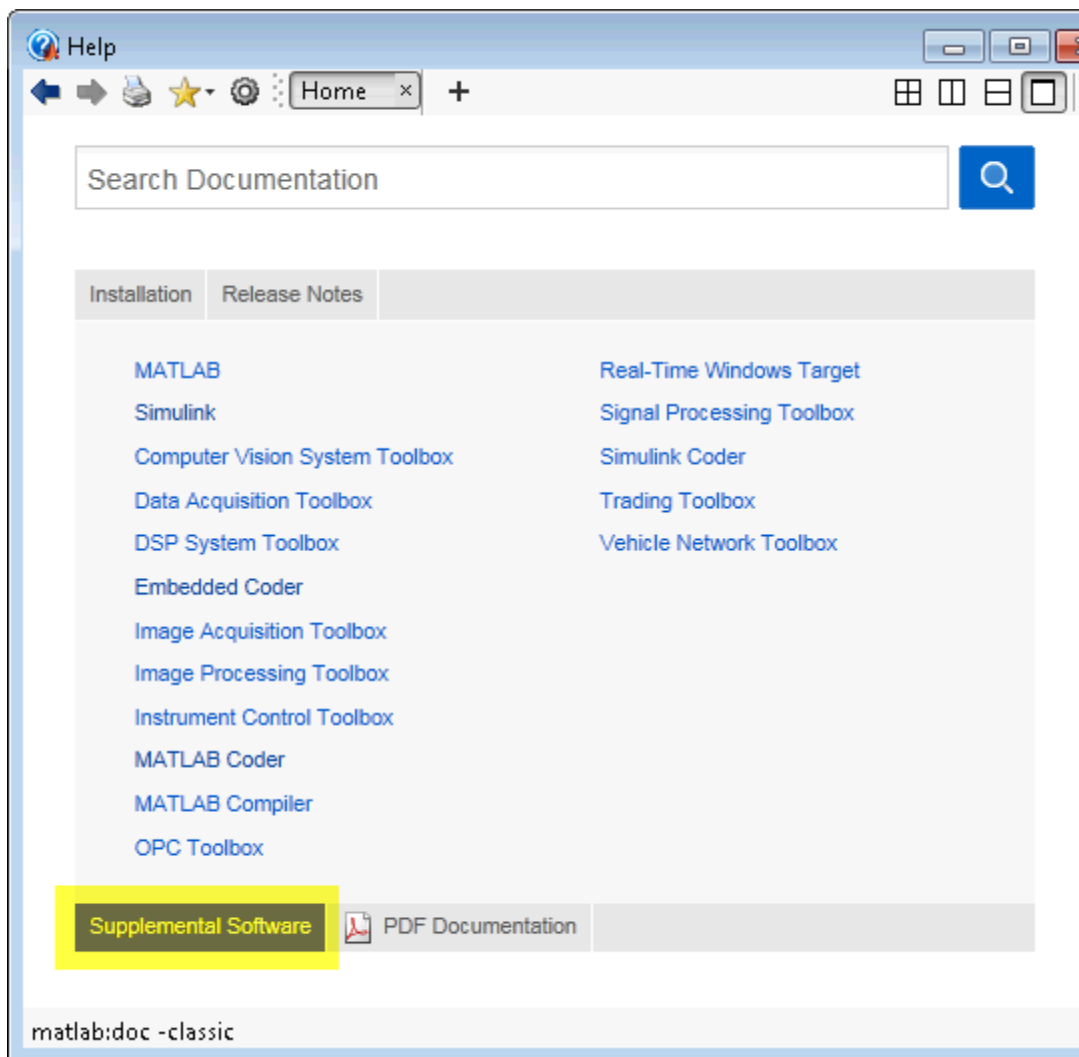

Install a Support Package on Multiple Computers

You can save time by downloading the support package files once and then reusing them on multiple computers.

This approach provides:

- Faster installations across multiple machines, such as in a classroom.
- Version control of the support package and most third-party software.
- Reduced Internet bandwidth usage and download times.

1 Download and install a support package from the Internet.

Note During that process, on the **Install or update support package** screen, you select the **Internet** option.

Support Package Installer saves the support package to a \downloads subfolder within the **Installation folder** displayed on the **Select a support package** screen. For example:
C:\MATLAB\SupportPackages\R2013a\downloads.

2 Locate the \downloads folder and make it available to other computers by:

- Sharing the folder on the local network. (In Microsoft, right-click the folder and select **Share**.)
- Copying the folder to a network drive.
- Copying the folder to a removable storage device, such as a USB flash drive.

Note If you have trouble locating the folder, run Support Package Installer again, select the support package on the **Select a support package** screen, and look at the **Installation folder** parameter.

3 Run Support Package Installer on each of the .

- 4** On the **Install or update support package** screen, select the **Folder** option, and use **Browse** to locate the \downloads folder on the network or removable storage device.
- 5** Complete the installation process.

Project and Build Configurations for Embedded Targets

- “Model Setup” on page 35-2
- “IDE Projects” on page 35-16
- “Makefiles for Software Build Tool Chains” on page 35-21

Model Setup

In this section...
“Block Selection” on page 35-2
“Configure Target Hardware Resources” on page 35-3
“Configuration Parameters” on page 35-5
“Model Reference” on page 35-14

Block Selection

You can create models for targeting the same way you create other Simulink models—by combining standard blocks and C-MEX S-functions.

You can use blocks from the following sources:

- The Embedded Targets library (`embeddedtargetslib`) in the Embedded Coder product.
- Blocks from the System Toolboxes products
- Custom blocks

Avoid using blocks that do not generate code, including the following blocks.

Block Name/Category	Library	Description
Scope	Simulink, DSP System Toolbox software	Provides oscilloscope view of your output. Do not use the Save data to workspace option on the Data history pane in the Scope Parameters dialog.
To Workspace	Simulink	Return data to your MATLAB workspace.
From Workspace	Simulink	Send data to your model from your MATLAB workspace.

Block Name/Category	Library	Description
Spectrum Scope	DSP System Toolbox	Compute and display the short-time FFT of a signal. It has internal buffering that can slow your process without adding value.
To File	Simulink	Send data to a file on your host machine.
From File	Simulink	Get data from a file on your host machine.
Triggered to Workspace	DSP System Toolbox	Send data to your MATLAB workspace.
Signal To Workspace	DSP System Toolbox	Send a signal to your MATLAB workspace.
Signal From Workspace	DSP System Toolbox	Get a signal from your MATLAB workspace.
Triggered Signal From Workspace	DSP System Toolbox	Get a signal from your MATLAB workspace.
To Wave device	DSP System Toolbox	Send data to a .wav device.
From Wave device	DSP System Toolbox	Get data from a .wav device.

Configure Target Hardware Resources

This topic contains the following subtopics:

- “About Supported IDEs” on page 35-4
- “Configure Parameters Under the Target Hardware Resources Tab” on page 35-4

About Supported IDEs

This “Configure Target Hardware Resources” on page 35-3 section applies to the following IDEs:

- Analog Devices VisualDSP++®
- Eclipse IDE
- Green Hills MULTI
- Texas Instruments Code Composer Studio™ 3.3
- Texas Instruments Code Composer Studio 4 (makefile generation only)
- Texas Instruments Code Composer Studio 5 (makefile generation only)
- Wind River Diab/GCC (makefile generation only)

Configure Parameters Under the Target Hardware Resources Tab

Configure the parameters under the Target Hardware Resources tab of your Simulink model for a specific tool chain and target hardware. Doing so updates other parameters in the Configuration Parameters dialog to the default values for the software build tool chain and target hardware you are using.

Note The Target Preferences (Removed) block has been removed from the Simulink block libraries for the Embedded Coder and Simulink Coder products.

Parameters in the Target Preferences block have been moved to the Target Hardware Resources tab.

To configure your Simulink model for a specific tool chain and target hardware:

- 1 In a Simulink model, open the model Configuration Parameters by:
 - Clicking the gear icon,



- Pressing **Ctrl+E** on your keyboard
 - Selecting the **Simulation > Model Configuration Parameters** menu items
- 2** In the Configuration Parameters dialog, click **Code Generation**, and then click “+” next to Code Generation. This action displays the sub-panes under Code Generation.
 - 3** On the Code Generation pane, change **System target file** to `idelink_ert.tlc` or `idelink_grt.tlc`.

The dialog displays a **Coder Target** pane under the Code Generation pane.

- 4** Select the **Coder Target** pane.
- 5** Select the **Target Hardware Resources** tab.
- 6** Set the following parameters to match the tool chain and target hardware you are using:
 - **IDE/Tool Chain**
 - **Board**
 - **Processor**
- 7** Review the other parameters under the **Target Hardware Resources** tab.
- 8** Click **Apply**, and save the changes to your model.

Configuration Parameters

- “What are Configuration Parameters?” on page 35-5
- “Setting Model Configuration Parameters” on page 35-6

What are Configuration Parameters?

To see the model Configuration Parameters, open the **Configuration Parameters** dialog. You can do this in the model editor by selecting

Simulation > Model Configuration Parameters, or by pressing **Ctrl+E** on your keyboard.

The **Configuration Parameters** dialog specifies the values for a model's active *configuration set*. These parameters determine the type of solver used, the import and export settings, and other values that determine how the model runs.

Setting Model Configuration Parameters

To set the Configuration Parameters to the right values for you to generate code from your model, see “Configure Parameters Under the Target Hardware Resources Tab” on page 35-4. This action initializes the model Configuration Parameters to the right default values for you to generate code. You can then use the Configuration Parameters dialog to make further modifications to the values. You can generate buildable code using these default values.

The following subsections provide a quick overview of the panes and parameters with which you are most likely to interact.

Code Generation Pane. When you set **System target file** to `idmlink_ert.tlc` or `idmlink_grt.tlc`, the dialog adds an **Coder Target** pane to the list of panes under **Code Generation**.

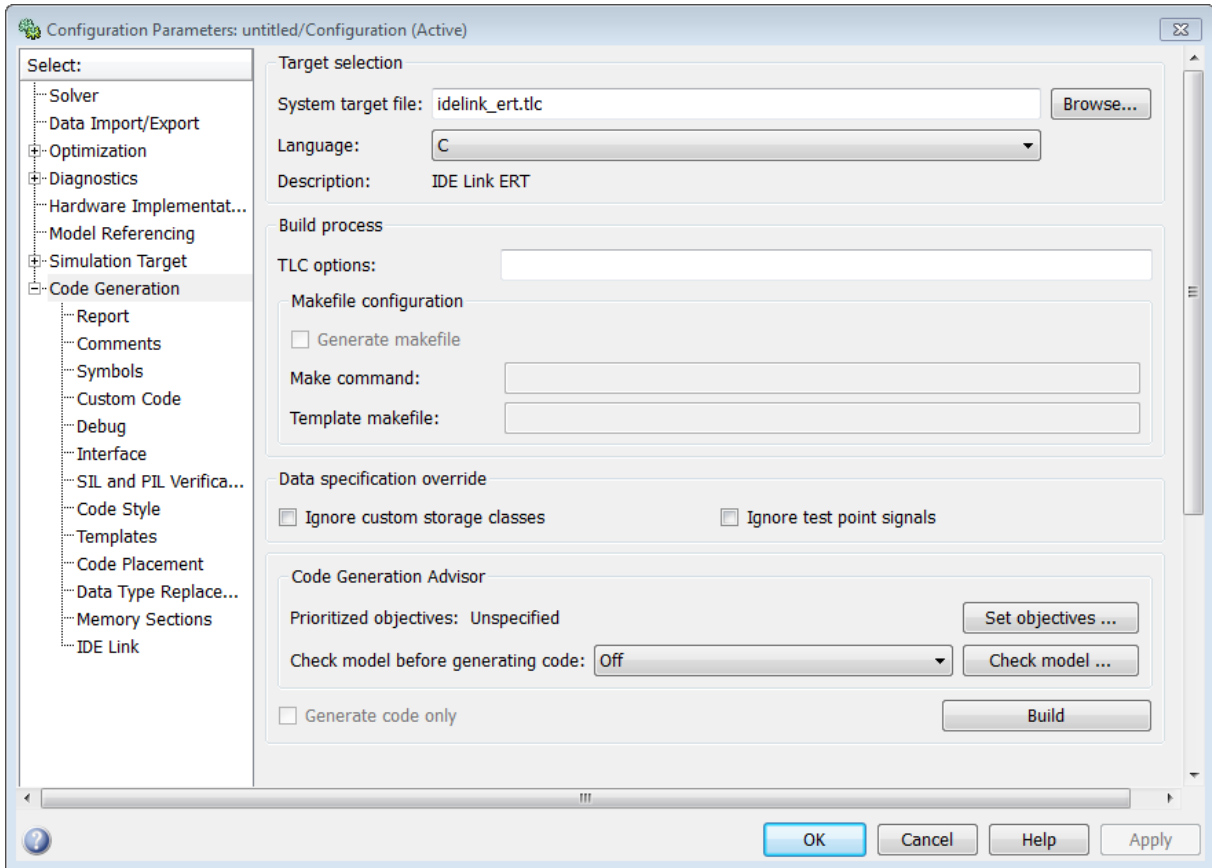

Leave **Language** set to C. The `idelink_ert.tlc` and `idelink_grt.tlc` system target files do not support C++ code generation.

For more information, see “Code Generation Pane: General”

Coder Target Pane Parameters.

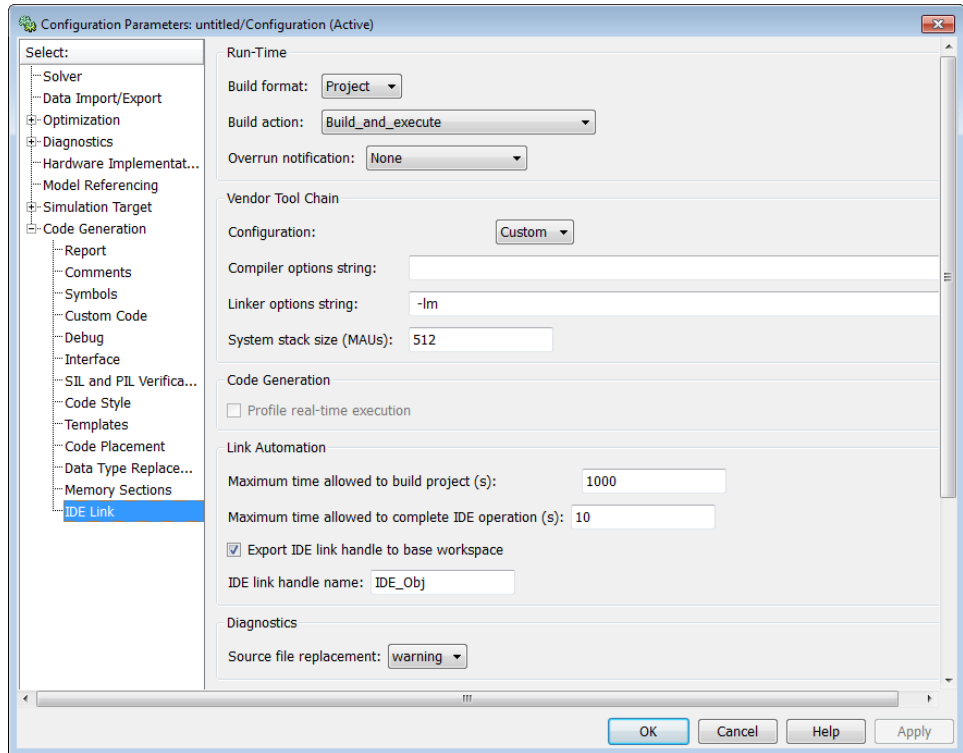

The Coder Target entry provides options in these areas:

- **Run-Time** — Set options for run-time operations, like the build action
- **Vendor Tool Chain** — Set compiler, linker, and system stack size options
- **Code Generation** — Configure your code generation requirements
- **Link Automation** — Export an IDE link handle object, such as `IDE_Obj`, to your MATLAB workspace
- **Diagnostics** — Determine how the code generation process responds when you use source code replacement in the **Custom Code** pane.

For more information, see [Code Generation Pane: Coder Target](#).

Build format

Select **Project** to create an IDE project, or select **Makefile** to create a makefile build script.

Build action

Your selection for **Build action** determines what happens when you click **Build** or press **Ctrl+B**. Your selection tells Simulink Coder software when to stop the code generation and build process.

To run your model on the processor, select **Build_and_execute**. This selection is the default build action.

The actions are cumulative—each action performs an additional step relative to the preceding action on the list.

If you set **Build format** to **Project**, select one of the following options:

- **Create_project** — Directs Simulink Coder software to start the IDE and populate a new project with the files from the build process. This option offers a convenient way to build projects in the IDE.
- **Archive_library** — Directs Simulink Coder software to create an archive library for this model. Use this option when you plan to use the model in a model reference application. Model reference requires that you archive your the IDE projects for models that you use in model referencing.
- **Build** — Builds the executable file, but does not download the file to the target hardware.
- **Build_and_execute** — Directs Simulink Coder software to build, download, and run your generated code as an executable on your target hardware.
- **Create_processor_in_the_loop_project** — Directs code generation process to create PIL algorithm object code as part of the project build. This option requires an Embedded Coder license.

If you set **Build format** to **Makefile**, select one of the following options:

- **Create_makefile** — Creates a makefile.

- `Archive_library` — Creates a makefile and the generated output will be an archive library.
- `Build` — Creates a makefile and an executable.
- `Build_and_execute` — Creates a makefile and an executable. Then it evaluates the execute instruction in the current configuration.

Overrun notification

To enable the overrun indicator, choose one of three ways for the target to respond to an overrun condition in your model:

- `None` — Ignore overruns encountered while running the model.
- `Print_message` — When the target encounters an overrun condition, it prints a message to the standard output device, `stdout`.
- `Call_custom_function` — Respond to overrun conditions by calling the custom function you identify in **Function name**.

Function name

When you select `Call_custom_function` from the **Overrun notification** list, you enable this option. Enter the name of the function the target should use to notify you that an overrun condition occurred. The function must exist in your code on the target hardware.

Configuration

The **Configuration** parameter defines sets of build options that apply to the files generated from your model.

The **Release** and **Debug** option apply build settings that are defined by your compiler. For more information, refer to your compiler documentation.

`Custom` has the same default values as **Release**, but:

- Leaves **Compiler options string** empty.

Compiler options string

To determine the degree of optimization provided by the optimizing compiler, enter the optimization level to apply to files in your project. For details about the compiler options, refer to your IDE documentation. When you create new projects, the coder product does not set optimization flags.

With Texas Instruments Code Composer Studio 3.3 and Analog Devices VisualDSP++, the user interface displays **Get From IDE** and **Reset** buttons next to this parameter. If you have an active project open in the IDE, you can click **Get From IDE** to import the compiler option setting from the current project in the IDE. To reset the compiler option to the default value, click **Reset**.

Linker options string

To specify the options provided by the linker during link time, you enter the linker options as a string. For details about the linker options, refer to your IDE documentation. When you create new projects, the coder product does not set linker options.

With Texas Instruments Code Composer Studio 3.3 and Analog Devices VisualDSP++, the user interface displays **Get From IDE** and **Reset** buttons next to this parameter. If you have an active project open in the IDE, you can click **Get From IDE** to import the linker options string from the current project in the IDE. To clear the linker options, click **Reset**.

System stack size (MAUs)

Enter the amount of memory that is available for allocating stack data, measured in minimum addressable units (MAU). Block output buffers are placed on the stack until the stack memory is fully allocated. After that, the output buffers go in global memory. An MAU is typically 1 byte, but its size can vary by target hardware.

This parameter is used in targets to allocate the stack size for the generated application. For example, with embedded processors that are not running an operating system, this parameter determines the total stack space that can be

used for the application. For such as Linux or VxWorks operating systems, this value specifies the stack space allocated per thread.

This parameter also applies to the “Maximum stack size (bytes)” parameter, located in the Optimization > Signals and Parameters pane.

System heap size (MAUs)

Set the default heap size that the target hardware reserves for dynamic memory allocation.

The target hardware uses this heap for functions like `printf()` and system services code.

The following IDEs use this parameter:

- Analog Devices VisualDSP++
- Green Hills MULTI
- IAR Embedded Workbench
- Wind River Diab/GCC (makefile generation only)

Profile real-time execution

To enable the real-time execution profile capability, select **Profile real-time execution**. With this selected, the build process instruments your code to provide performance profiling at the task level or for atomic subsystems. When you run your code, the executed code reports the profiling information in an HTML report.

Link Automation

When you build a model for a target, the coder product automatically creates or uses an existing *IDE link handle object* (named `IDE_Obj`, by default) to connect to your IDE.

Although `IDE_Obj` is a handle for a specific instance of the IDE, it also contains information about the IDE instance to which it refers, such as the target the IDE accesses. In this pane, the **Export IDE link handle to base workspace** option lets you instruct the coder product to export the object to your MATLAB workspace, giving it the name you assign in **IDE link handle name**.

You can also use the IDE link handle object to interact with the IDE using IDE Automation Interface commands.

Maximum time allowed to build project (s)

Specifies how long the software waits for the IDE to build the software.

Maximum time allowed to complete IDE operation (s)

Specifies how long the software waits for IDE functions, such as `read` or `write`, to return completion messages. If you do not specify a timeout, the default value is 10 seconds.

Export IDE link handle to base workspace

Directs the software to export the `IDE_Obj` object to your MATLAB workspace.

IDE link handle name

Specifies the name of the `IDE_Obj` object that the build process creates.

Source file replacement

Selects the diagnostic action to take if the software detects conflicts when you replace source code with custom code. The diagnostic message responds to both source file replacement in the Configuration Parameters under Code

Generation > Coder Target parameters and under Code Generation > Custom Code.

The following settings define the messages you see and how the code generation process responds:

- **none** — Does not generate warnings or errors when it finds conflicts.
- **warning** — Displays a warning. `warn` is the default value.
- **error** — Terminates the build process and displays an error message that identifies which file has the problem and suggests how to resolve it.

The build operation continues if you select `warning` and the software detects custom code replacement problems. You see warning messages as the build progresses.

Select `error` the first time you build your project after you specify custom code to use. The error messages can help you diagnose problems with your custom code replacement files. Use `none` when the replacement process works and you do not want to see multiple messages during your build.

Model Reference

The `idmlink_ert.tlc` and `idmlink_grt.tlc` system target files provide support for generating code from models that use Model Reference. A referenced model will generate an archive library.

To enable Model Reference builds:

- 1** Open your referenced model.
- 2** Select Simulation > Model Configuration Parameters from the model menus.
- 3** From the list of panes under **Code Generation**, choose **Coder Target**.
- 4** In the right pane, under Run-Time, select `Archive_library` from the **Build action** list.

If your top-model uses a reference model that does not have the **Build action** set to `Archive_library`, the build process automatically changes the **Build action** to `Archive_library` and issues a warning about the change.

Configuration Parameters in Reference Models

Use the same Coder Target pane settings in Configuration Parameters for the models in the model hierarchy.

IDE Projects

In this section...

“Support for Third Party Products” on page 35-16

“Third Party Product Setup” on page 35-16

“Code Generation and Build” on page 35-18

“Automation of IDE Tasks and Processes” on page 35-19

Support for Third Party Products

For more information about Embedded Coder support for third-party IDEs and targets, see the following links, organized by vendor:

- Analog Devices VisualDSP++ IDE and Blackfin® processors —
<http://www.mathworks.com/products/embedded-coder/adi-adaptor.html>
- Eclipse IDE with GNU GCC—
<http://www.mathworks.com/products/embedded-coder/eclipse-adaptor.html>
- Green Hills MULTI —
<http://www.mathworks.com/products/embedded-coder/ghs-adaptor.html>
- Texas Instruments Code Composer Studio IDE,
and C2000™, C5000™, C6000™ processors —
<http://www.mathworks.com/products/embedded-coder/ti-adaptor.html>
- ARM® —
<http://www.mathworks.com/products/embedded-coder/arm-adaptor/>
- Wind River VxWorks —
<http://www.mathworks.com/products/embedded-coder/windriver-adaptor/>

Third Party Product Setup

Install your third party IDE or software build tool chain according to the vendor’s instructions.

If you are using one of the following IDEs, perform the additional steps described here:

Analog Devices VisualDSP++ IDE

Use the `adivdspsetup` command to complete the configuration and install a plug-in in VisualDSP++. The reference page provides a brief example. Also see “Working with Analog Devices VisualDSP++ IDE”.

Eclipse IDE

Complete the instructions in “Installing Third-Party Software for Eclipse” on page 39-2 and in “Configuring Your MathWorks Software to Work with Eclipse” on page 39-10.

Green Hills MULTI IDE

See “Working with Green Hills MULTI IDE”.

Texas Instruments Code Composer Studio 3.3 IDE

Before you use Embedded Coder with Code Composer Studio (CCS IDE) for the first time, use the `checkEnvSetup` function to check for third-party tools and set environment variables. Run `checkEnvSetup` again whenever you configure CCS IDE to interact with a new board or processor, or upgrade the related third-party tools.

To verify that CCSv3 is installed on your machine and has at least one board configured, enter

```
ccsboardinfo
```

in the MATLAB Command Window. With CCS installed and configured, MATLAB software returns information about the boards that CCS recognizes on your machine, in a form similar to the following listing.

Board Num	Board Name	Proc Num	Processor Name	Processor Type
1	C6xxx Simulator (Texas Instrum	.0	6701	TMS320C6701
0	C6x13 DSK (Texas Instruments)	0	CPU	TMS320C6x1x

If MATLAB software does not return information about the boards, open your CCS installation and use the Setup Utility in CCS to configure at least one board.

As a final test, start CCS to verify that it runs. For Embedded Coder to operate with CCS, the CCS IDE must be able to run on its own.

Also see “Working with Texas Instruments Code Composer Studio IDE”.

Texas Instruments Code Composer Studio 4 IDE

Before you use Embedded Coder with Code Composer Studio (CCS IDE) for the first time, use the `checkEnvSetup` function to check for third-party tools and set environment variables. Run `checkEnvSetup` again whenever you configure CCS IDE to interact with a new board or processor, or upgrade the related third-party tools.

Also see “Working with Texas Instruments Code Composer Studio IDE”.

Code Generation and Build

Building Your Model

In your model, click **Build Model** . The software performs the actions you selected for **Build action** in the model Configuration Parameters, under Code Generation > Coder Target.

IDE Project Generator Features

The *IDE Project Generator* component provides or supports the following features for developing IDE projects and generating code:

- Automatically create IDE projects for your generated code during the code generation process.
- Customize code generation using options in the model Configuration Parameters.
- Configure the automatic project build process.

- Automatically download and run your generated projects on your target hardware.

IDE Link Handle Objects

IDE Project Generator automatically creates and uses an IDE link handle object to communicate with your IDE and target hardware.

To create the IDE link handle object, IDE Project Generator uses one of the following constructor functions:

- `adivdsp` for Analog Devices VisualDSP++
- `eclipseide` for Eclipse IDE
- `ghsmulti` for Green Hills MULTI
- `ticcs` for Texas Instruments Code Composer Studio

For a command line example of how to use a constructor function, see the corresponding reference page for each function.

Automation of IDE Tasks and Processes

The *IDE Automation Interface* component provides a powerful API for automating IDE tasks via MATLAB scripts. For example, with IDE Automation Interface, your script can automatically:

- Automate project creation, including adding source files, include paths, and preprocessor defines
- Configure batch building of projects
- Launch a debugging session

Examples of IDE Automation Interface for Specific IDEs

To help you become familiar with IDE Automation Interface, you can use the “IDE Automation Interface Tutorial” example for the following IDEs:

- Green Hills MULTI
- Eclipse IDE

- Analog Devices VisualDSP++
- Texas Instruments Code Composer Studio

The example shows you how to:

- 1** Configure and create an IDE link handle object.
- 2** Create and query objects in an IDE.
- 3** Use MATLAB software to load files into your IDE.
- 4** Work with your IDE project from MATLAB software.
- 5** Close connections you the IDE.

Makefiles for Software Build Tool Chains

In this section...

“What is the XMakefile Feature” on page 35-21

“Using Makefiles to Generate and Build Software” on page 35-25

“Making an XMakefile Configuration Operational” on page 35-28

“Creating a New XMakefile Configuration” on page 35-28

“XMakefile User Configuration dialog” on page 35-34

What is the XMakefile Feature

- “Overview” on page 35-21
- “Supported Tool Chains in Embedded Coder” on page 35-22
- “Available XMakefile Configurations” on page 35-22
- “Feature Support” on page 35-24

Overview

You can use makefiles instead of IDE projects during the automated software build process. This approach is described in “Using Makefiles to Generate and Build Software” on page 35-25.

The XMakefile feature lets you choose the *configuration* of a specific software build tool chain to use during the automated build process. The configuration contains paths and settings for your make utility, compiler, linker, archiver, pre-build, post-build, and execute tools.

You can choose one built-in configuration described in “Supported Tool Chains in Embedded Coder” on page 35-22 and “Available XMakefile Configurations” on page 35-22.

You can also create a new configuration for a new tool chain, as described in “Creating a New XMakefile Configuration” on page 35-28.

Your requirements for specific features may determine whether you choose makefiles or IDE projects. See “Feature Support” on page 35-24.

Supported Tool Chains in Embedded Coder

Embedded Coder includes support for the following IDEs and tool chains.

Tool Chain	Processor Family/Target Operating System	Host Operating System
Analog Devices VisualDSP++	Blackfin, SHARC®, and TigerSHARC®	Windows
Green Hills MULTI	ARM, Analog Devices Blackfin, PowerPC®, and Renesas® v850	Linux, Windows
GNU development tools	Linux	Linux
GNU development tools	ARM	MontaVista Linux
Texas Instruments Code Composer Studio 3.3, 4, and 5.1	Texas Instruments C2000, C5500™, and C6000	Windows
Wind River Diab/GCC	ARM9, Host Simulator, VxWorks, RTP and RTP_SO	Windows
Xilinx ISE Design Suite	ARM Cortex-A9 on Xilinx Zynq-7000 running Linux	32-bit and 64-bit Windows

Simulink Coder includes support for other IDEs and tool chains. See “Supported Tool Chains in Simulink Coder”.

Available XMakefile Configurations

The following list describes the configurations in the XMakefile dialog that this product supports:

- `adivdsp_blackfin`: Analog Devices VisualDSP++ & Analog Devices Blackfin

- `adivdsp_sharc`: Analog Devices VisualDSP++ & Analog Devices SHARC
- `adivdsp_tigersharc`: Analog Devices VisualDSP++ & Analog Devices TigerSHARC
- `gcc_target`: GNU Compiler Collection & Host Operating System or Embedded Operating System
- `ghsmulti_arm`: Green Hills MULTI & ARM
- `ghsmulti_blackfin`: Green Hills MULTI & Analog Devices Blackfin
- `ghsmulti_ppc`: Green Hills MULTI & PowerPC
- `ghsmulti_v850`: Green Hills MULTI & Renesas V850
- `ticcs_c2000_ccsv3`: Texas Instruments Code Composer Studio 3 & Texas Instruments C2000
- `ticcs_c2000_ccsv4`: Texas Instruments Code Composer Studio 4 & Texas Instruments C2000
- `ticcs_c2000_ccsv5`: Texas Instruments Code Composer Studio 5.1 & Texas Instruments C2000
- `ticcs_c5500_ccsv3`: Texas Instruments Code Composer Studio 3 & Texas Instruments C5500
- `ticcs_c5500_ccsv4`: Texas Instruments Code Composer Studio 4 & Texas Instruments C5500
- `ticcs_c5500_ccsv5`: Texas Instruments Code Composer Studio 5.1 & Texas Instruments C5500
- `ticcs_c6000_ccsv3`: Texas Instruments Code Composer Studio 3 & Texas Instruments C6000
- `ticcs_c6000_ccsv4`: Texas Instruments Code Composer Studio 4 & Texas Instruments C6000
- `ticcs_c6000_ccsv5`: Texas Instruments Code Composer Studio 5.1 & Texas Instruments C6000
- `ticcs_c6000_dspbios_ccsv3`: Texas Instruments Code Composer Studio 3 & Texas Instruments DSP/BIOS on C6000
- `ticcs_c6000_dspbios_ccsv4`: Texas Instruments Code Composer Studio 4 & Texas Instruments DSP/BIOS on C6000

- `ticcs_c6000_dspbios_ccsv5`: Texas Instruments Code Composer Studio 5.1 & Texas Instruments DSP/BIOS on C6000
- `wrsdiab_arm9_vxworks67_rtp`: Wind River Systems DIAB Compiler & ARM 9 & VxWorks 6.7 & real-time process applications
- `wrsdiab_arm9_vxworks67_rtp_so`: Wind River Systems DIAB Compiler & ARM 9 & VxWorks 6.7 & real-time process applications with shared object
- `wrsdiab_hostsim_vxworks67_rtp`: Wind River Systems DIAB Compiler & VxWorks Host Simulator & VxWorks 6.7 & real-time process applications
- `wrsdiab_hostsim_vxworks67_rtp_so`: Wind River Systems DIAB Compiler & VxWorks Host Simulator & VxWorks 6.7 & real-time process applications with shared object
- `wrsdiab_hostsim_vxworks68_rtp`: Wind River Systems DIAB Compiler & VxWorks Host Simulator & VxWorks 6.8 & real-time process applications
- `wrsdiab_hostsim_vxworks68_rtp_so`: Wind River Systems DIAB Compiler & VxWorks Host Simulator & VxWorks 6.8 & real-time process applications with shared object
- `wrsgnu_arm9_vxworks67_rtp`: Wind River Systems GNU Compiler & VxWorks Host Simulator & VxWorks 6.7 & real-time process applications
- `wrsgnu_hostsim_vxworks67_rtp`: Wind River Systems GNU Compiler & VxWorks Host Simulator & VxWorks 6.7 & real-time process applications with shared object
- `wrsgnu_hostsim_vxworks68_rtp`: Wind River Systems GNU Compiler & VxWorks Host Simulator & VxWorks 6.8 & real-time process applications with shared object
- `xilinx_ise_14_x`: Xilinx ISE Design Suite & ARM Cortex-A9 running Linux on Xilinx Zynq-7000 platform

For more information about supported versions of third-party software, see “Support for Third Party Products” on page 35-16

Feature Support

With makefiles, you cannot use features that rely on direct communications between your MathWorks software and third-party IDEs.

You cannot use the following features with makefiles:

- IDE Project Generation
- IDE Automation Interface
- IDE debugger communications during Processor-in-the-loop (PIL) simulation

Using Makefiles to Generate and Build Software

In addition to this chapter, see the Makefile Generator Tutorial example for more information about using makefiles to generate code.

Configuring Your Model to Use Makefiles

Update your model Configuration Parameters to use a makefile instead of an IDE when you build software from the model:

- 1** Configure your model for your IDE, tool chain, and target hardware, as described in “Configure Target Hardware Resources” on page 35-3.
- 2** In the Configuration Parameters dialog, under the **Code Generation** tab, select **Coder Target**.
- 3** Set **Build format** to **Makefile**. For more information, see **Build format** on page 9.
- 4** Set **Build action** to **Build_and_execute**. For more information, see **Build action** on page 9.

Choosing an XMakefile Configuration

Configure how to generate makefiles:

- 1** Enter `xmakefilesetup` on the MATLAB Command Window. The software opens an XMakefile User Configuration dialog.

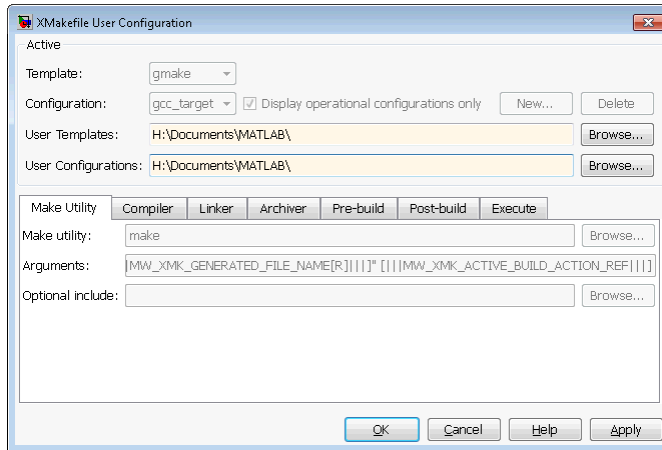

- 2 Set the **Template** parameter to the option that matches the **Configuration** parameter.

Note In most cases, the only option for **Template** is `gmake`. However, if you have installed a Support Package, **Template** can have multiple options.

- 3 For **Configuration**, select the option that describes your software build toolchain and target platform. Click **Apply**.

Note Changing some elements of the XMakefile dialog disables other elements until you apply the changes. Click **Apply** or **OK** after changing:

- **Template**
 - **Configurations**
 - **User Templates**
 - **User Configurations**
 - **Tool Directories**
-

Note With the XMakefile User Configuration dialog, if you have an Embedded Coder license and do not have a Simulink Coder license, the **Configuration** list includes two unsupported options: `gcc_target` or `msvs_host`. Disregard those two configurations. Choose one of the other configurations.

Things to consider while setting **Configuration**:

- Selecting **Display operational configurations only** hides configurations that contain incomplete or invalid information. For a configuration to be operational, the vendor tool chain must be installed, and the configuration must have the valid paths for each component of the vendor tool chain. For more information, see “Making an XMakefile Configuration Operational” on page 35-28.
- To display the configurations, including non-operational configurations, clear **Display operational configurations only**.
- The list of configurations can include non-editable configurations defined in the software and editable configurations defined by you.
- To create a new editable configuration, use the **New** button.
- For more information, see “XMakefile User Configuration dialog” on page 35-34.

Building Your Model

In your model, click **Build Model** . This action creates a makefile and performs the other actions you specified in **Build action**.

By default, this process outputs files in the `<builddir>/<buildconfiguration>` folder. For example, in `model_name/CustomMW`.

Green Hills MULTI Output Folder

With Green Hills MULTI, Embedded Coder outputs the derived files in the `<builddir>` folder. For example, in `model_ghsmulti`.

Making an XMakefile Configuration Operational

When the XMakefile utility starts, it checks each configuration file to verify that the specified paths for the vendor tool chain are valid. If the paths are not valid, the configuration is non-operational. Typically, the cause of this problem is a difference between the path in the configuration and the actual path of the vendor toolchain.

To make a configuration operational:

- 1** Clear **Display operational configurations only** to display non-operational configurations.
- 2** Select the non-operational configuration from the **Configuration** options.
- 3** When you click **Apply**, a new dialog prompts you for the folder path of the missing resources the configuration requires.

Use mapped network drives instead of UNC paths to specify directory locations. Using UNC paths with compilers that do not support them causes build errors.

Creating a New XMakefile Configuration

- “Overview” on page 35-28
- “Create a Configuration” on page 35-29
- “Modify the Configuration” on page 35-30
- “Test the Configuration” on page 35-33

Overview

This example shows you how to add support for a software development toolchain to the XMakefile utility. This example uses the Intel Compiler and Eclipse IDE, which provides an open framework and allows for otherwise unsupported toolchains.

Note To specify directory locations, use mapped network drives instead of UNC paths. UNC paths cause build errors with compilers that do not support them.

Create a Configuration

When you click **New**, the new configuration inherits values and behavior from the current configuration. To create a configuration for the Intel Compiler, clone a configuration from one of these configurations: `msvs_host`, `mingw_host`, `montavista_arm` and `gcc_target`.

Open the XMakefile User Configuration UI by typing `xmakefilesetup` at the MATLAB prompt. This action displays the following dialog.

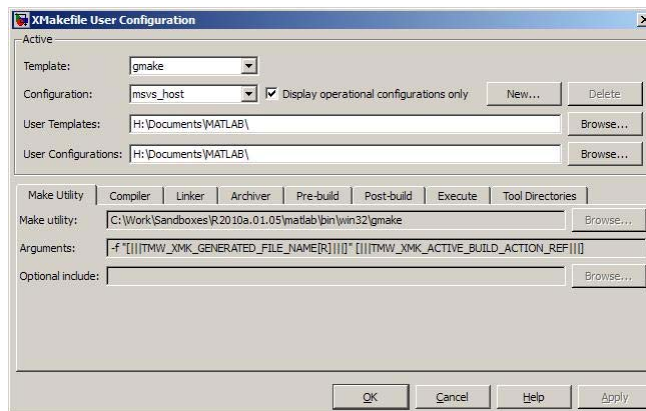

Select an existing configuration, such as `msvs_host`, `mingw_host`, `montavista_arm` or `gcc_target`. Click the **New** button.

A pop-up dialog prompts you for the name of the new configuration. Enter `intel_compiler` and click **OK**.



The dialog displays a new configuration called `intel_compiler`, based on the previous configuration.

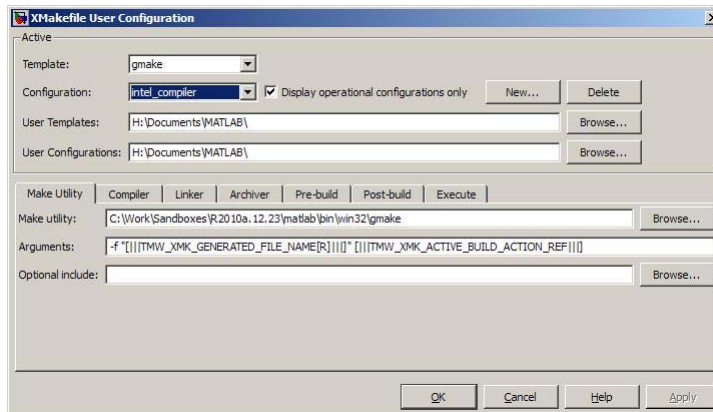

Modify the Configuration

Adjust the compiler, linker, and archiver settings of the newly created configuration. This example assumes the location of the Intel compiler is `C:\Program Files\Intel\Compiler\`.

Make Utility. You do not need to make changes. This configuration uses the `gmake` tool that ships with MATLAB.

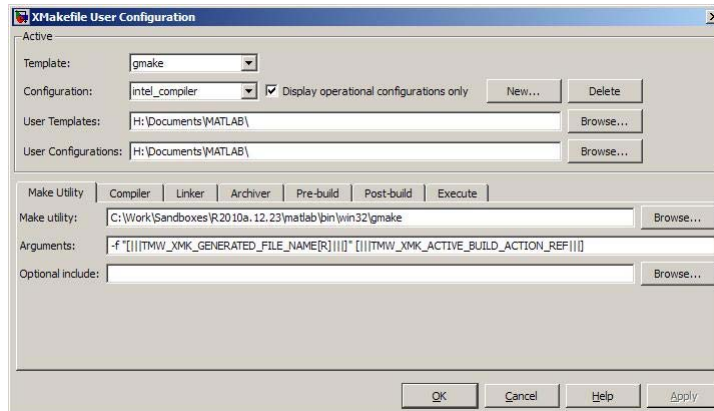

Compiler. For **Compiler**, enter the location of `icl.exe` in the Intel installation.

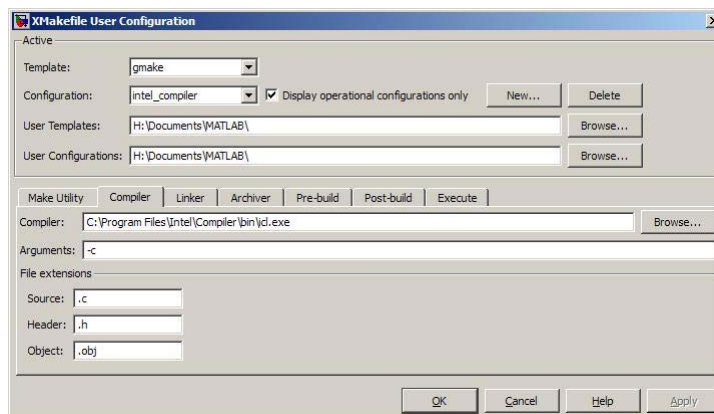

Linker. For **Linker**, enter the location of the linker executable, `xilink.exe`.

For **Arguments**, add the `/LIBPATH` path to the Intel libraries.

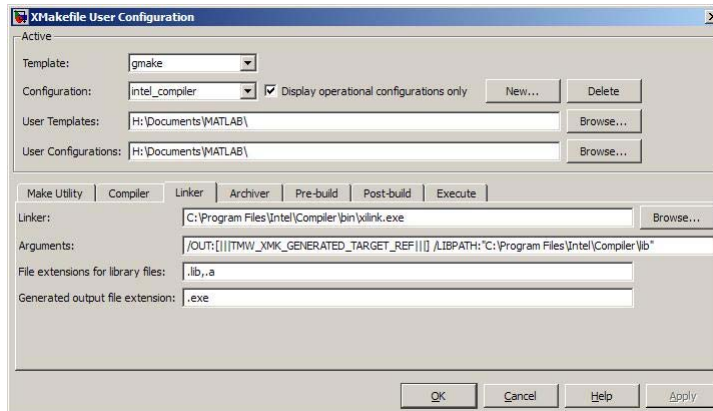

Archiver. For **Archiver**, enter the location of the archiver, `xilib.exe`. Confirm that **File extensions for library files** includes `.lib`.

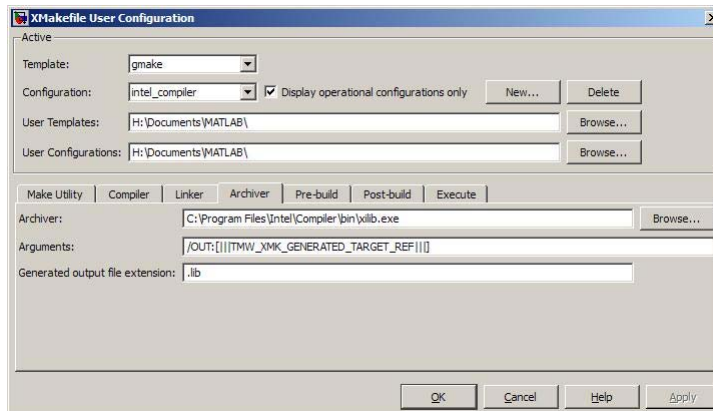

Other tabs. For this example, ignore the remaining tabs. In other circumstances, you can use them to configure additional build actions. In a later step of this example, you will configure the software to automatically build and run the generated code.

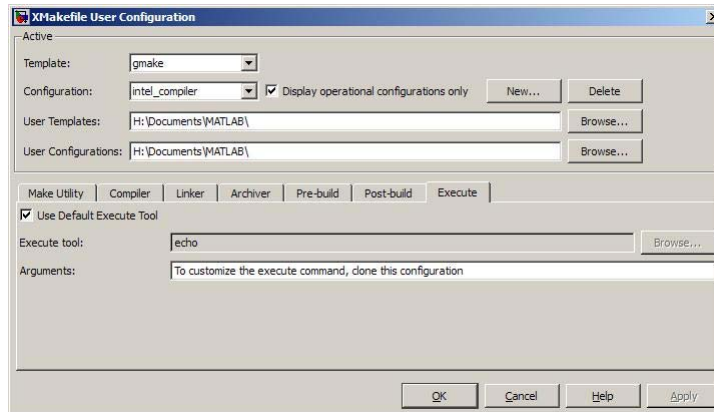

Test the Configuration

Open the “sumdiff” model by entering `sumdiff` on the MATLAB prompt.

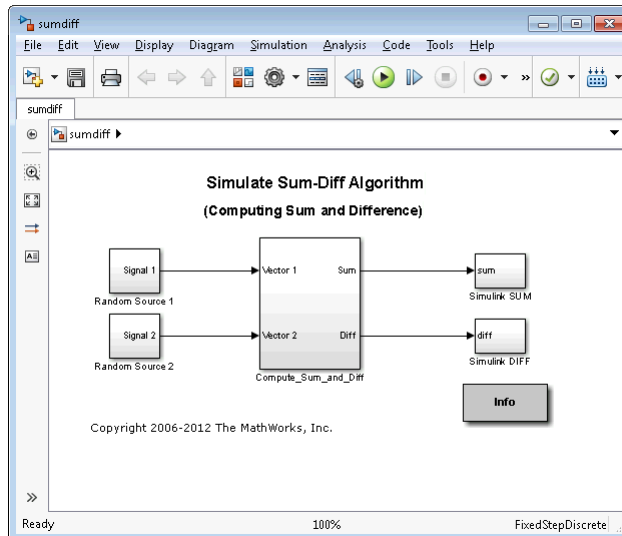

Configure the `sumdiff` model for use with the Eclipse IDE. Follow the steps in “Configure Target Hardware Resources” on page 35-3, setting **IDE/Tool Chain** to Eclipse, set **Board** to Custom, and **Processor** to Intel x86/Pentium.

On the Tool Chain Automation page, set **Operating System** to None or select Windows. Click **OK**.

Open the Configuration Parameters for the sumdiff model by pressing **Ctrl+E**. Set **Build format** to Makefile and **Build action** to Build_and_execute.

Save the model to a temporary location, such as C:\Temp\IntelTest\.

Set that location as a Current Folder by typing `cd C:\temp\IntelTest\` at the MATLAB prompt.

Build the model by pressing **Ctrl+B**. The MATLAB Command Window displays something like:

```
### TLC code generation complete.  
### Creating HTML report file sumdiff_codegen_rpt.html  
### Creating project: c:\temp\IntelTest\sumdiff_eclipseide\sumdiff.mk  
### Project creation done.  
### Building project...  
### Build done.  
### Downloading program: c:\temp\IntelTest\sumdiff_eclipseide\sumdiff  
### Download done.
```

A command window comes up showing the running model. Terminate the generated executable by pressing **Ctrl+C**.

XMakefile User Configuration dialog

- “Active” on page 35-35
- “Make Utility” on page 35-37
- “Compiler” on page 35-37
- “Linker” on page 35-38
- “Archiver” on page 35-38
- “Pre-build” on page 35-39
- “Post-build” on page 35-39

- “Execute” on page 35-40
- “Tool Directories” on page 35-40

Active

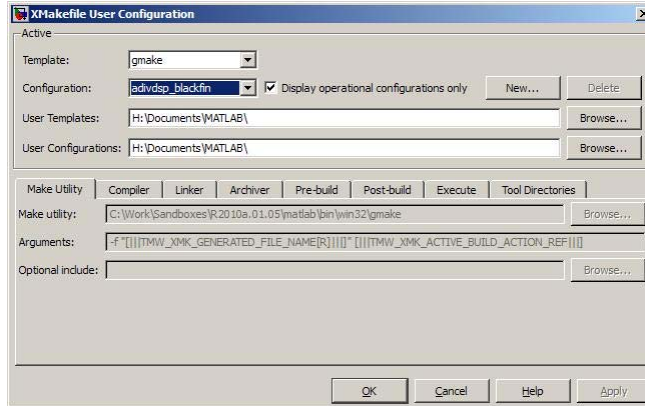

Template. Set the **Template** parameter to the option that matches the **Configuration** parameter.

Note In most cases, the only option for **Template** is **gmake**. However, if you have installed a Support Package, **Template** can have multiple options.

The template defines the syntax rules for writing the contents of the makefile or buildfile. The default template is **gmake**, which works with the GNU make utility.

To add templates to this parameter, save them as **.mkt** files to the location specified by the **User Templates** parameter. For more information, see “User Templates” on page 35-36.

Configuration. Select the configuration that best describes your toolchain and target hardware.

You cannot edit or delete the configurations provided by MathWorks. You can, however, edit and delete the configurations that you create.

Use the **New** button to create an editable copy of the currently selected configuration.

Use the **Delete** button to delete a configuration you created.

Note You cannot edit or delete the configurations provided by MathWorks.

Note Use mapped network drives instead of UNC paths to specify directory locations. Using UNC paths with compilers that do not support them causes build errors.

Display operational configurations only. When you open the XMakefile User Configuration dialog, the software verifies that each configuration provided by MathWorks contains valid paths to the executable files it uses. If the paths are valid, the configuration is operational. If the paths are not valid, the configuration is not operational.

This setting only applies to configurations provided by MathWorks, not configurations you create.

To display valid configurations, select **Display operational configurations only**.

To display the configurations, including non-operational configurations, clear **Display operational configurations only**.

For more information, see “Making an XMakefile Configuration Operational” on page 35-28.

User Templates. Set the path of the folder to which you can add template files. Saving templates files with the .mkt extension to this folder adds them to the **Templates** options.

User Configurations. Set the location of configuration files you create with the **New** button.

Make Utility

The screenshot shows a dialog box titled 'Make Utility' with several tabs: 'Make Utility', 'Compiler', 'Linker', 'Archiver', 'Pre-build', 'Post-build', and 'Execute'. The 'Make Utility' tab is active. It contains three input fields: 'Make utility:' with the text 'gmake', 'Arguments:', and 'Optional include:'. Each of these fields has a 'Browse...' button to its right.

Make utility. Set the path and filename of the make utility executable.

Arguments. Define the command-line arguments to pass to the make utility. For more information, consult the third-party documentation for your make utility.

Optional include. Set the path and file name of an optional makefile to include.

Compiler

The screenshot shows a dialog box titled 'Compiler' with several tabs: 'Make Utility', 'Compiler', 'Linker', 'Archiver', 'Pre-build', 'Post-build', and 'Execute'. The 'Compiler' tab is active. It contains three input fields: 'Compiler:', 'Arguments:', and 'File extensions'. The 'File extensions' section has three sub-fields: 'Source:' with the text '.c', 'Header:' with the text '.h', and 'Object:'.

Compiler. Set the path and file name of the compiler executable.

Arguments. Define the command-line arguments to pass to the compiler. For more information, consult the third-party documentation for your compiler.

Source. Define the file name extension for the source files. Use commas to separate multiple file extensions.

Header. Define the file name extension for the header files. Use commas to separate multiple file extensions.

Object. Define the file name extension for the object files.

Linker

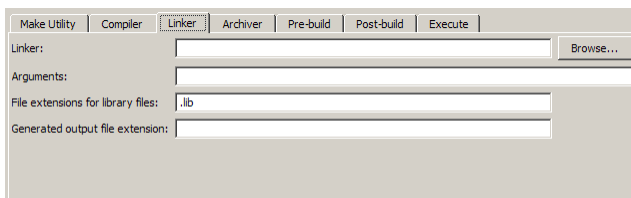

The screenshot shows a configuration dialog box with several tabs: "Make Utility", "Compiler", "Linker", "Archiver", "Pre-build", "Post-build", and "Execute". The "Linker" tab is selected. It contains four input fields: "Linker:" with a "Browse..." button, "Arguments:", "File extensions for library files:" (containing ".lib"), and "Generated output file extension:".

Linker. Set the path and file name of the linker executable.

Arguments. Define the command-line arguments to pass to the linker. For more information, consult the third-party documentation for your linker.

File extensions for library files. Define the file name extension for the file library files. Use commas to separate multiple file extensions.

Generated output file extension. Define the file name extension for the generated libraries or executables.

Archiver

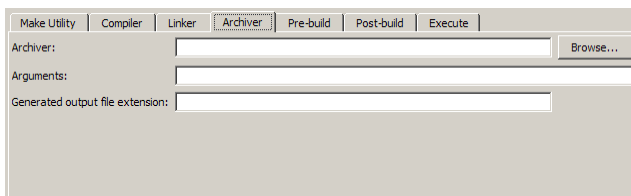

The screenshot shows a configuration dialog box with several tabs: "Make Utility", "Compiler", "Linker", "Archiver", "Pre-build", "Post-build", and "Execute". The "Archiver" tab is selected. It contains three input fields: "Archiver:" with a "Browse..." button, "Arguments:", and "Generated output file extension:".

Archiver. Set the path and file name of the archiver executable.

Arguments. Define the command-line arguments to pass to the archiver. For more information, consult the third-party documentation for your archiver.

Generated output file extension. Define the file name extension for the generated libraries.

Pre-build

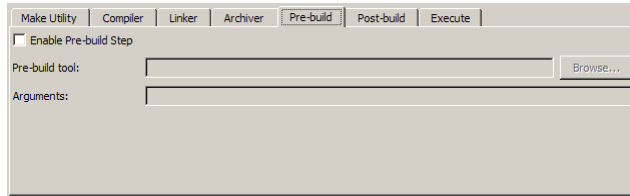

The screenshot shows a dialog box titled "Pre-build" with a tabbed interface. The tabs are "Make Utility", "Compiler", "Linker", "Archiver", "Pre-build" (selected), "Post-build", and "Execute". Inside the dialog, there is a checkbox labeled "Enable Pre-build Step". Below it, there is a text field for "Pre-build tool:" with a "Browse..." button to its right. Below that, there is a text field for "Arguments:".

Enable Prebuild Step. Select this check box to define a prebuild tool that runs before the compiler.

Prebuild tool. Set the path and file name of the prebuild tool executable.

Arguments. Define the command-line arguments to pass to the prebuild tool. For more information, consult the third-party documentation for your prebuild tool.

Post-build

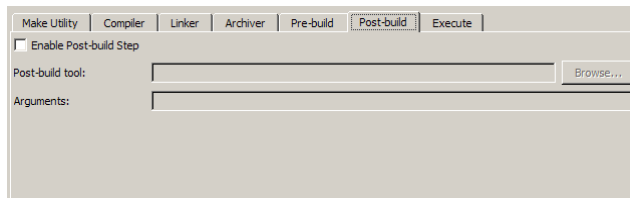

The screenshot shows a dialog box titled "Post-build" with a tabbed interface. The tabs are "Make Utility", "Compiler", "Linker", "Archiver", "Pre-build", "Post-build" (selected), and "Execute". Inside the dialog, there is a checkbox labeled "Enable Post-build Step". Below it, there is a text field for "Post-build tool:" with a "Browse..." button to its right. Below that, there is a text field for "Arguments:".

Enable Postbuild Step. Select this check box to define a postbuild tool that runs after the compiler or linker.

Postbuild tool. Set the path and file name of the postbuild tool executable.

Arguments. Define the command-line arguments to pass to the postbuild tool. For more information, consult the third-party documentation for your postbuild tool.

Execute

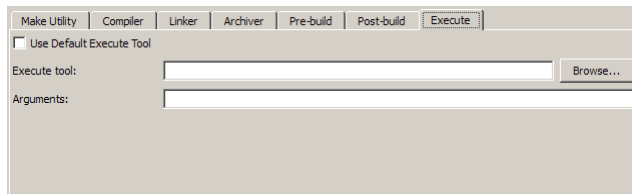

Use Default Execute Tool. Select this check box to use the generated derivative as the execute tool when the build process is complete. Uncheck it to specify a different tool. The default value, `echo`, simply displays a message that the build process is complete.

Note On the Linux operating system, multirate multitasking executables require root privileges to schedule POSIX threads with real-time priority. If you are using makefiles to build multirate multitasking executables on your Linux development system, you cannot use **Execute tool** to run the executable. Instead, use the Linux command, `sudo`, to run the executable.

Execute tool. Set the path and file name of the execute tool executable or built-in command.

Arguments. Define the command-line arguments to pass to the execute tool. For more information, consult the third-party documentation for your execute tool.

Tool Directories

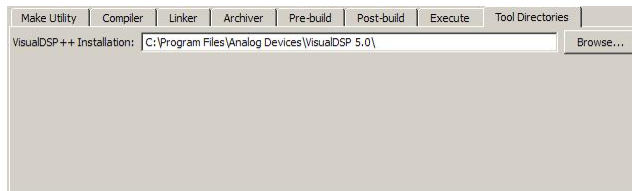

Installation. Use the Tool Directories tab to change the toolchain path of an operational configuration.

For example, if you installed two versions of a vendor build tool in separate folders, you can use the **Installation** path to change which one the configuration uses.

Verification and Profiling Code Generated for Embedded Targets

- “Processor-in-the-Loop (PIL) Simulation” on page 36-2
- “Execution Profiling for Embedded Targets” on page 36-21
- “Stack Profiling for Embedded Targets” on page 36-28

Processor-in-the-Loop (PIL) Simulation

In this section...

“Overview” on page 36-2

“PIL Approaches” on page 36-3

“Communications” on page 36-8

“Running Your PIL Application to Perform Simulation and Verification” on page 36-14

“Performing a Model Block PIL Simulation via SCI Using Makefiles” on page 36-14

“Definitions” on page 36-18

“PIL Issues and Limitations” on page 36-19

Overview

Verification consists broadly of running generated code on a processor and verifying that the code does what you intend. Embedded Coder provides processor-in-the-loop (PIL) simulation to meet this need. PIL compares the numeric output of your model under simulation with the numeric output of your model running as an executable on a target hardware.

With PIL, you run your generated code on a target hardware or instruction set simulator. To verify your generated code, you compare the output of model simulation modes, such as Normal or Accelerator, with the output of the generated code running on the processor. You can switch between simulation and PIL modes. This flexibility allows you to verify the generated code by executing the model as compiled code in the target environment. You can model and test your embedded software component in Simulink and then reuse your regression test suites across simulation and compiled object code. This process avoids the time-consuming process of leaving the Simulink software environment to run tests again on object code compiled for the production hardware.

Embedded Coder supports the following PIL approaches:

- Model block PIL

- Top-model PIL
- PIL block

When you use makefiles with PIL, use the “model block PIL” approach. With makefiles, the other two approaches, “top-model PIL” and “PIL block”, and are not supported.

PIL Approaches

- “Model Block PIL” on page 36-3
- “Top-Model PIL” on page 36-4
- “PIL Block” on page 36-6

Model Block PIL

Use model block PIL to:

- Verify code generated for referenced models (model reference code interface).
- Provide a test harness model (or a system model) to generate test vector or stimulus inputs.
- Switch a model block between normal, SIL, or PIL simulation modes.

To perform a model block PIL simulation, start with a top-model that contains a model block. The top-model serves as a test harness, providing inputs and outputs for the model block. The model block references the model you plan to run on target hardware. During PIL simulation, the referenced model runs on the target hardware.

For more information about using the model block, see Model Variants and “Model Reference”.

By default, your MathWorks software uses the IDE debugger for PIL communications with the target hardware. To achieve faster communications, consider using one alternatives presented in “Communications” on page 36-8.

To use model block PIL:

- 1 Create and share a configuration reference between the top model and the referenced model, as described in “Share a Configuration for Multiple Models”.
- 2 Right-click the Model block, and select **ModelReference Parameters**.
- 3 When the software displays the **Function Block Parameters: Model** dialog, set **Simulation mode** to **Processor-in-the-loop (PIL)** and click **OK**.
- 4 Open the model block.
- 5 In the referenced model (model block) Configuration Parameters (**Ctrl+E**), under **Code Generation > Coder Target**, set **Build action** set to **Archive_library**. This action avoids a warning when you start the simulation.
- 6 Save the changes to both models.
- 7 In the top-model menu bar, select **Simulation > Run**. This action builds the referenced model in the model block, downloads it to your target hardware, and runs the PIL simulation.

Note In the top-model Configuration Parameters (**Ctrl+E**), under **Code Generation > Coder Target**, leave **Build action** set to **Build_and_execute**. Do not change **Build action** to **Create_Processor_In_the_Loop_Project**.

Top-Model PIL

Use top-model PIL to:

- Verify code generated for a top-model (standalone code interface).
- Load test vectors or stimulus inputs from the MATLAB workspace.
- Switch the entire model between normal and SIL or PIL simulation modes.

Setting Model Configuration Parameters to Generate the PIL

Application. Configure your model to generate the PIL executable from your model:

- 1 Configure your model to run on target hardware, as described in “Configure Target Hardware Resources” on page 35-3.
- 2 From the model toolstrip, select **Simulation > Model Configuration Parameters**.
- 3 In Configuration Parameters, select **Code Generation**.
- 4 Set **System Target File** to `idmlink_ert.tlc`.
- 5 From the list of panes under **Code Generation**, choose **Coder Target**.
- 6 Set **Build format** to Project.
- 7 Set **Build action** to `Create_processor_in_the_loop_project`.
- 8 Click **OK** to close the Configuration Parameters dialog.

For more information, see “Code Generation: Coder Target Pane”.

Running the Top-Model PIL Application. To create a PIL block, perform the following steps:

- 1 In the model toolstrip, set the Simulation mode to Processor - in - the - loop.

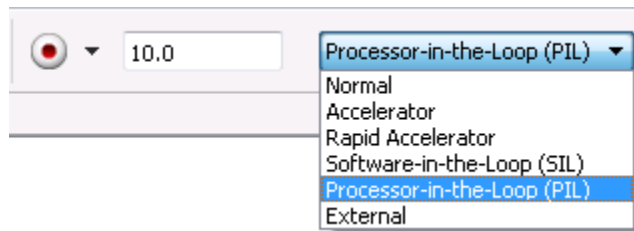

- 2 In the model toolstrip, click **Run**.



A new Simulink Editor opens with the new PIL model block in it. The third-party IDE compiles and links the PIL executable file. Follow the progress of the build process in the MATLAB command window.

PIL Block

Use the PIL block to:

- Verify code generated for a top-model (standalone code interface) or subsystem (right-click build standalone code interface).
- Represent a component running in SIL or PIL mode. The test harness model or a system model provides test vector or stimulus inputs.

Preparing Your Model to Generate a PIL Block. Start with a model that contains the algorithm blocks you want to verify on the processor as compiled object code. To create a PIL application and PIL block from your algorithm subsystem, follow these steps:

- 1 Identify the algorithm blocks to cosimulate.
- 2 Convert those blocks into an unmasked subsystem in your model.

For information about how to convert your process to a subsystem, refer to Creating Subsystems in *Using Simulink* or in the online Help system.

- 3 Open the newly created subsystem.
- 4 Configure your subsystem to run on target hardware, as described in “Configure Target Hardware Resources” on page 35-3.

Setting Model Configuration Parameters to Generate the PIL Application. After you create your subsystem, set the Configuration Parameters for your model to enable the model to generate a PIL block.

Configure your model to enable it to generate PIL algorithm code and a PIL block from your subsystem:

- 1 From the model menu bar, select **Simulation > Model Configuration Parameters**. This action opens the Configuration Parameters dialog.

- 2** In the Configuration Parameters dialog, select **Code Generation**.
- 3** Set **System Target File** to `idmlink_ert.tlc`.
- 4** From the list of panes under **Code Generation**, choose **Coder Target**.
- 5** Set **Build format** to **Project**.
- 6** Set **Build action** to `Create_processor_in_the_loop_project`.
- 7** Click **OK** to close the Configuration Parameters dialog.

For more information, see “Code Generation: Coder Target Pane”.

Creating the PIL Block from a Subsystem. To create a PIL block, perform the following steps:

- 1** Right-click the masked subsystem in your model and select **C/C++ Code > Build This Subsystem** from the context menu.

A new Simulink Editor opens and the new PIL block appears in it. The third-party IDE compiles and links the PIL executable file.

This step builds the PIL algorithm object code and a PIL block that corresponds to the subsystem, with the same inputs and outputs. Follow the progress of the build process in the MATLAB command window.

- 2** Copy the new PIL block from the new model to your model. To simulate the subsystem processes concurrently, place it parallel to your masked subsystem. Otherwise, replace the subsystem with the PIL block.

To see a PIL block in a parallel masked subsystem, search the product help for *Getting Started with Application Development* and select the example that matches your IDE.

Note Models can have multiple PIL blocks for different subsystems. They cannot have more than one PIL block for the same subsystem. Including multiple PIL blocks for the same subsystem causes errors and inaccurate results.

Communications

- “TCP/IP” on page 36-9
- “Additional Steps for TI C6000 Processors” on page 36-10
- “Serial Communication Interface (SCI) for Texas Instruments C2000” on page 36-11
- “IDE Debugger” on page 36-13

Chose one of the following communication methods for transferring code and data during PIL simulations:

Method	Speed	Comments
IDE Debugger	Slow	<ul style="list-style-type: none"> • Supports PIL communications with an executable running an embedded target hardware.
TCP/IP	Fast	<ul style="list-style-type: none"> • Supports PIL communications with an executable running on a Linux or Windows host. • Supports embedded targets running Linux, TI DSP/BIOS, and Wind River VxWorks. • Requires network connection between host and target hardware. • Works with builds from IDE projects and from makefiles.
Serial Communication Interface (SCI)	Fast	<ul style="list-style-type: none"> • Supports PIL communications with an executable running an embedded target hardware. • Supports only TI C28035 and C28335 microcontrollers. • Requires an SCI connection between host and target hardware. • Works with builds from IDE projects and from makefiles.

TCP/IP

You can use TCP/IP for PIL communications with a hardware target running:

- Linux
- Texas Instruments DSP/BIOS
- Wind River VxWorks

Using TCP/IP for PIL communications is typically faster than using a debugger, particularly for large data sets, such as with video and audio applications.

It also works well when you build an application on a remote Linux target using the `remoteBuild` function.

You can use TCP/IP with the following PIL approaches:

- Top-model PIL
- Model block PIL

TCP/IP does not work with the Subsystem PIL approach.

To enable and configure TCP/IP with PIL:

- 1** Set up a PIL simulation according to the PIL approach you have chosen.
- 2** In the MATLAB Command Window, use `setpref` to specify the IP address of the PIL server (`servername`).

If you are running the PIL server on a remote target, specify the IP address of the target hardware. For example:

```
setpref('MathWorks_Embedded_IDE_Link_PIL_Preferences', 'servername', '144.212.109.114');
```

If you are running PIL server locally, on your host Windows or Linux system, enter `'localhost'` instead of an IP address:

```
setpref('MathWorks_Embedded_IDE_Link_PIL_Preferences', 'servername', 'localhost');
```

- 3 Specify the TCP/IP port number to use for PIL data communication. Use one of the free ports in your system. For example:

```
setpref('MathWorks_Embedded_IDE_Link_PIL_Preferences','portnum', 17025);
```

- 4 Enable PIL communications over TCP/IP:

```
setpref('MathWorks_Embedded_IDE_Link_PIL_Preferences','enabletcpip', true);
```

To disable PIL communications over TCP/IP, change the value to `false`. This action automatically enables PIL communications over an IDE debugger, if an IDE is available.

- 5 Open the Configuration Parameters in your model. On the Coder Target pane, set the **Operating System** parameter to the operating system your target hardware is running.

Note You cannot use TCP/IP for PIL when the value of **Operating System** is None.

- 6 Regenerate the code or PIL block.

To disable PIL communications over TCP/IP, enter:

```
setpref('MathWorks_Embedded_IDE_Link_PIL_Preferences','enabletcpip', false);
```

Additional Steps for TI C6000 Processors

Add an IP Config block to the following location in your model:

- For top-model PIL, add it at the top level of your model.
- For model block PIL, add it to the referenced model to which you are pointing.
- For Subsystem PIL, place it in the subsystem.

Configure the IP Config block settings as described in C6000 IP Config.

To determine the IP address assigned to the PIL server on the C6000 target:

- 1** Enter an arbitrary IP address the first time you specify the IP address.
- 2** Build and run the code for your model.
- 3** In the CCS command window, observe the actual IP address assigned to the C6000 processor by the DHCP server.
- 4** Enter the actual IP address the second time you specify the IP address.

Serial Communication Interface (SCI) for Texas Instruments C2000

You can use SCI for processor-in-the-loop (PIL) simulations with Texas Instruments C2000 processors that support Serial Communications Interface (SCI). For other targets, configure PIL to communicate through TCP/IP or an IDE debugger.

SCI typically provides faster communications than an IDE debugger, particularly for large data sets.

To enable and configure SCI with PIL:

- 1** Set up a PIL simulation according to the PIL approach you have chosen. For more information, see “PIL Approaches” on page 36-3.
- 2** In the MATLAB Command Window, use `setpref` to specify the Configuration Parameters:
 - a** Select the SCI port on your host computer that will be used for communicating with the target hardware. For example, to use COM1, enter the following command:

```
setpref('MathWorks_Embedded_IDE_Link_PIL_Preferences', 'COMPort', 'COM1');
```
 - b** Set the baud rate of the SCI port. For example, if both the host computer and the target support 115200 baud, enter:

```
setpref('MathWorks_Embedded_IDE_Link_PIL_Preferences', 'BaudRate', 115200);
```
 - c** Enable PIL communications over SCI:

```
setpref('MathWorks_Embedded_IDE_Link_PIL_Preferences', 'enableserial', true);
```

- 3** Configure the serial communications settings on your host computer to match the preceding values. For example, in Windows 7:
 - a** Open the Windows Device Manager. (Press the Windows key on your keyboard and search for “Device Manager”.)
 - b** Expand **Ports (COM & LPT1)**.
 - c** Right-click the communications port you previously specified in MATLAB, such as **Communications Port (COM1)**, and select **Properties**.
 - d** Go to the **Port Settings** tab, and match the value of **Bits per second** with the baud rate you previously specified in MATLAB. This value should match the baud rate you set in MATLAB. For example, 'BaudRate', 115200.
- 4** Regenerate the code or PIL block.

Note: In serial PIL simulation, the changes that you make to the BaudRate or COMPort parameters in MathWorks_Embedded_IDE_Link_PIL_Preferences are not detected, if the following conditions are met:

- You have already built your PIL application.
- You have set the **Configuration Parameters >Model Referencing >Rebuild** option to a value other than Always.
- You have not made any changes to the model.

To apply your COM port or baudrate changes, either change the value in the **Configuration Parameters >Model Referencing >Rebuild** option to Always, or re-save the model to force a new build of the PIL application.

To disable PIL communications over SCI, enter:

```
setpref('MathWorks_Embedded_IDE_Link_PIL_Preferences','enableserial',false);
```

See “Performing a Model Block PIL Simulation via SCI Using Makefiles” on page 36-14

IDE Debugger

To enable PIL communications over an IDE debugger, disable PIL communications over TCP/IP and SCI by entering the following commands:

```
setpref('MathWorks_Embedded_IDE_Link_PIL_Preferences','enabletcpip',false);
setpref('MathWorks_Embedded_IDE_Link_PIL_Preferences','enableserial',false);
```

Then regenerate the code or PIL block.

Using IDE debugger for PIL communication only works when you build your code from IDE projects. Using IDE debugger for PIL communication does not work with builds from makefiles.

Configuring Breakpoints. You can use the `setStartApplicationPause` API to set breakpoints in the PIL application on the *first* PIL block simulation. If you do not use the `setStartApplicationPause` API, you can configure breakpoints after the initial run. The breakpoints remain active for subsequent runs.

You can enter the following static API method to pause after loading the application and manually configure breakpoints:

```
rtw.connectivity.Launcher.setStartApplicationPause(pauseAmount)
```

About this method:

- This method tells the MATLAB session to pause immediately after the PIL launcher starts the PIL application.
- `pauseAmount` is a pause time in seconds. To disable the pause, enter 0.

When you do not specify a pause, the software displays the following message:

```
### To pause during PIL application start, run: >> rtw.connectivity.Launcher.
setStartApplicationPause(120)
```

The default pause is 120 sec. You can change this value.

When you specify a pause, a Start PIL Application Pause message box appears and displays following message:

```
Pausing during PIL application start for 120s (click OK to continue).
To disable this pause, see the hyperlink in the MATLAB command window.
```

- The MATLAB command window shows the following text:

```
### To remove the pause during PIL application start,  
run: >> rtw.connectivity.Launcher. setStartApplicationPause(0)
```

where `rtw.connectivity.Launcher. setStartApplicationPause(0)` is a [hyperlink](#).

- The pause times out, or you can clear it early by closing the message box.
- During the pause, you cannot access MATLAB and thus cannot configure breakpoints programmatically via the IDE Automation Interface API.
- For the PIL block, the debugger stays open between simulation runs. When you perform an initial simulation run, you can automatically configure breakpoints via the IDE Automation Interface API before starting the second simulation.

Running Your PIL Application to Perform Simulation and Verification

After you add your PIL block to your model, click **Simulation > Run** or press **Ctrl+T** to run the PIL simulation and view the results.

Performing a Model Block PIL Simulation via SCI Using Makefiles

This example shows you the complete workflow for performing a processor-in-the loop (PIL) simulation that uses Serial Communications Interface (SCI) for communications.

Prerequisites

Follow the board vendor's instructions for setting up a Texas Instruments C2000-based board that supports SCI. Connect the board to your host computer using a serial cable.

Configure Your Model for Target Hardware

- 1 Enter `fuelsys_pil` in MATLAB. This action opens the `fuelsys_pil` model with the title, "Verifying the Fixed-Point Fuel Control System".

- 2** Configure `fuelsys_pil`. Follow the steps in “Configure Target Hardware Resources” on page 35-3 setting:
 - **IDE/Tool Chain** to the version of CCS you are using.
 - **Board** to a board that supports using SCI, such as SD F28335 eZdsp.
- 3** Click **Yes**.

If you are working with CCSv3, configure `fuelsys_pil` to use makefiles:

- 1** Select **Simulation > Model Configuration Parameters**.
- 2** In the Configuration Parameters dialog, expand **Code Generation** and select **Coder Target**.
- 3** On the Coder Target pane, set **Build format** to **Makefile**.

If you are working with CCSv4/5, you do not need to configure the model to use makefiles. Initializing the configuration parameters for CCSv4/5 automatically sets **Build format** to **Makefile**.

Configure Your Model for the Model Block PIL Approach

- 1** In the `fuelsys_pil`, copy the `fuelsys_ctr` model and paste it into the vacant space below. Connect it to the input/output signals provided.

Verifying the Fixed-Point Fuel Control System

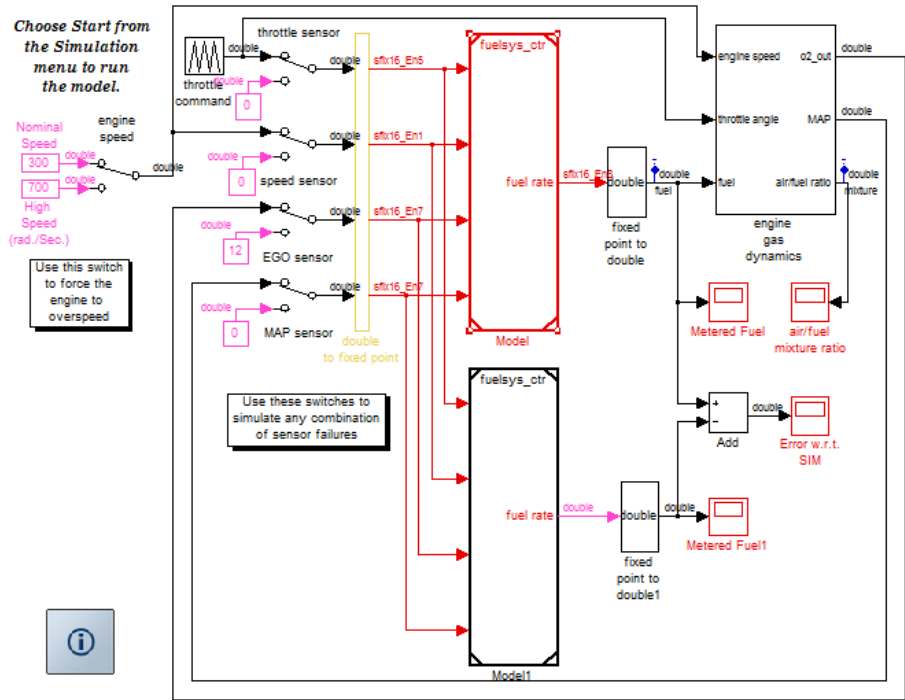

Copyright 2005-2011 The MathWorks, Inc.

- 2 Right-click the upper `fuelsys_ctr` model, labeled “Model”, and select **ModelReference Parameters**.
- 3 In the **Function Block Parameters: Model** dialog, set the **Simulation mode** parameter to Processor-in-the-loop (PIL). Click the OK button.
- 4 Open the upper `fuelsys_ctr` model, labeled “Model”.
- 5 From the menu in the open `fuelsys_ctr` model, select **Simulation > Model Configuration Parameters** (or press **Ctrl+E**).
- 6 In the Configuration Parameters dialog, in the **Solver** pane, set the **Type** parameter to Fixed-step, and set **Solver** to ode3 (Bogacki-Shampine).

7 In the MATLAB Command Window, enter:

```
set_param('fuelsys_ctr', 'ModelReferenceSymbolNameMessage', 'none')
```

8 In the **Code Generation > Interface** pane, clear the Software environment **absolute time** check box.

9 In the **Code Generation > Coder Target** pane, set the Run time **Build action** parameter to Archive library.

10 Save the changes to your model, and leave the model open.

11 Open the top model, fuelsys_pil. Open the Configuration Parameters dialog, in the **Solver** pane, verify that the **Type** parameter is set to Fixed-step, and reset **Solver** to ode3 (Bogacki-Shampine).

Note For information other PIL approaches, see “PIL Approaches” on page 36-3.

Enable and configure SCI

1 Use setpref to specify the Configuration Parameters in MATLAB :

```
setpref('MathWorks_Embedded_IDE_Link_PIL_Preferences', 'COMPort', 'COM1');
setpref('MathWorks_Embedded_IDE_Link_PIL_Preferences', 'BaudRate', 115200);
setpref('MathWorks_Embedded_IDE_Link_PIL_Preferences', 'enableserial', true);
```

2 Configure the serial communications settings on your host computer to match the preceding values. For example, in Windows 7:

- a** Open the Windows Device Manager. (Press the Windows key on your keyboard and search for “Device Manager”.)
- b** Expand **Ports (COM & LPT1)**.
- c** Right-click the communications port you previously specified in MATLAB, such as **Communications Port (COM1)**, and select **Properties**.
- d** Go to the **Port Settings** tab, and match the value of **Bits per second** with the baud rate you previously specified in MATLAB. This value

should match the baud rate you set in MATLAB. For example, 'BaudRate', 115200.

Configure the Software to Use Makefiles

- 1** Enter `xmakefilesetup` in MATLAB. This action opens the **XMakefile User Configuration** dialog.
- 2** In the dialog, set the **Configuration** parameter to `ticcs_c2000_ccsv3`, `ticcs_c2000_ccsv4`, or `ticcs_c2000_ccsv5`. To see more options, clear the **Display operational configurations only** check box.
- 3** Click the **Apply** button, and respond to messages requesting the location of your tool chain.
- 4** Click the **OK** button.
- 5** Load and run the embedded software on the target hardware, as described in “Load and Run the Embedded Software Using DSS” on page 43-7.

Run the PIL Simulation

- 1** Make sure the SD F28335 eZdsp board is connected to your host computer via serial and USB cables and powered up.
- 2** Simulate the `fuelsys_pil` model (press **Ctrl+T**).

Definitions

PIL Algorithm

The algorithmic code, which corresponds to a subsystem or portion of a model, to test during the PIL simulation. The PIL algorithm is in compiled object form to enable verification at the object level.

PIL Application

The executable application that runs on the processor platform. Your coder product creates a PIL application by augmenting your algorithmic code with

the PIL execution framework. The PIL execution framework code compiles as part of your embedded application.

The PIL execution framework code includes the `string.h` header file so that the PIL application can use the `memcpy` function. The PIL application uses `memcpy` to exchange data between the Simulink model and the simulation processor.

PIL Block

When you build a subsystem from a model for PIL, the process creates a PIL block optimized for PIL simulation. When you run the simulation, the PIL block acts as the interface between the model and the PIL application running on the processor. The PIL block inherits the signal names and shape from the source subsystem in your model. Inheritance is convenient for copying the PIL block into the model to replace the original subsystem for simulation.

PIL Issues and Limitations

Consider the following issues when you work with PIL blocks.

Constraints

When using PIL in your models, keep the following constraints in mind:

- Models can have multiple PIL blocks for different subsystems. They cannot have more than one PIL block for the same subsystem. Including multiple PIL blocks for the same subsystem causes errors and inaccurate results.
- A model can contain a single model block running PIL mode.
- A model can contain a subsystem PIL block or a model block in PIL mode, but not both.

Generic PIL Issues

Refer to PIL Feature Support and Limitations for general information about using the PIL block with embedded link products.

With Texas Instruments CCS, PIL with DSP/BIOS Enabled Does Not Support System Stack Profiling

Enabling DSP/BIOS for Texas Instruments processors disables the stack profiling option. To use stack profiling with PIL, open the **Target Hardware Resources** pane in model Configuration Parameters, and set the **Operating System** parameter to **None**. For help opening the Target Hardware Resources pane, see “Configure Target Hardware Resources” on page 35-3.

Simulink Coder grt.tlc-Based Targets Not Supported

PIL does not support `grt.tlc` system target files.

To use PIL, set **System target file** in the Configuration Parameters > Code Generation pane to `idmlink_ert.tlc`.

Execution Profiling for Embedded Targets

In this section...

“What Is Execution Profiling?” on page 36-21

“Feature Support” on page 36-21

“Execution Profiling during Standalone Execution” on page 36-22

“Execution Profiling during PIL Simulation” on page 36-25

What Is Execution Profiling?

You can measure the execution performance of the generated code running on your target hardware with Execution Profiler. This feature can be used to measure CPU utilization during standalone target hardware execution or processor-in-the-loop (PIL) simulation.

Your software includes a set of utilities for profiling execution of generated code on target hardware. The utilities profile execution times for synchronous tasks, asynchronous tasks, and atomic subsystems. You can perform execution profiling during standalone execution or processor-in-the-loop (PIL) simulation.

Note To profile by atomic subsystems, your model must include at least one atomic subsystem. To learn more about creating atomic subsystems, refer to "Creating Subsystems" in the online help for Simulink software.

Feature Support

Execution profiling is supported on embedded targets, except those running VxWorks.

Execution profiling is not supported on desktop targets, which are a capability of Simulink Coder.

Execution Profiling during Standalone Execution

In standalone execution, instrumented code in the generated code collects a user-specified number of execution time samples and stores in target hardware memory. Once target hardware execution is halted the profile function can be called to transfer profiling data from target hardware memory to the MATLAB workspace for viewing and analysis.

Feature Support

Execution profiling during standalone execution requires IDE projects (**Build format** = `Project`), which is supported with the following IDEs:

- Analog Devices VisualDSP++
- Eclipse IDE
- Green Hills MULTI
- Texas Instruments Code Composer Studio 3.3

Execution profiling during standalone execution is not supported when using makefiles (**Build format** = `Makefile`).

During standalone execution, you can perform profiling by tasks (synchronous and asynchronous) or by atomic subsystems.

Profiling by Tasks

To configure a model to use task execution profiling, perform the following steps:

- 1** Open the Configuration Parameters dialog for your model.
- 2** Select the **Coder Target** pane under the **Code Generation** pane.
- 3** Set **Build format** to `Project` and set **Build action** to `Build_and_execute`.
- 4** Select **Profile real-time execution**.
- 5** In the **Profile by** list, select **Tasks**.

- 6 Set the **Number of profiling samples to collect**. This is the size of the buffer used to hold profiling data. Enter 2 times the number of samples.
- 7 Click **OK** to close the Configuration Parameters dialog.

To view the execution profile for your model:

- 1 Click **Build Model**  on the model toolstrip. This action builds, loads, and runs your code on the processor.
- 2 To stop the running program, select **Debug > Halt** in the IDE or use `IDE_obj.halt` from the MATLAB command prompt. Gathering profiling data from a running program may yield inaccurate results.

- 3 At the MATLAB command prompt, enter

```
profile(IDE_Obj, 'execution', 'report')
```

to view the MATLAB software graphic of the execution report and the HTML execution report.

For more information about other reporting options, see the product help for the `profile` function.

The profiling plot from running an application that has three rates—the base rate and two slower rates. Gaps in the Sub-Rate2 task bars indicate preempted operations.

Profiling by Subsystems

When your models use atomic subsystems, you have the option of profiling your code based on the subsystems.

To configure a model to use subsystem execution profiling, perform the following steps:

- 1 Configure your model for your IDE, tool chain, and target hardware, as described in “Configure Target Hardware Resources” on page 35-3.
- 2 On the **Coder Target** pane, set **Build format** to Project and set **Build action** to `Build_and_execute`.

- 3** Select **Profile real-time execution**.
- 4** In the **Profile by** list, select **Atomic subsystems**.
- 5** Set the **Number of profiling samples to collect**. This is the size of the buffer used to hold profiling data. Enter 2 times the number of samples.
- 6** Click **OK** to close the Configuration Parameters dialog.

To view the execution profile for your model:

- 1** Click **Build Model**  on the model toolstrip. This action builds, loads, and runs your code on the processor.
- 2** To stop the running program, select **Debug > Halt** in the IDE or use `IDE_obj.halt` from the MATLAB command prompt. Gathering profiling data from a running program may yield inaccurate results.
- 3** At the MATLAB command prompt, enter:

At the MATLAB command prompt, enter:

```
profile(IDE_Obj, 'execution', 'report')
```

to view the MATLAB software graphic of the execution report and the HTML execution report.

For more information, see the product help for the `profile` function.

The profiling plot from running an application that has three subsystems—For Iterator Subsystem, For Iterator Subsystem1, and Idle Task Subsystem.

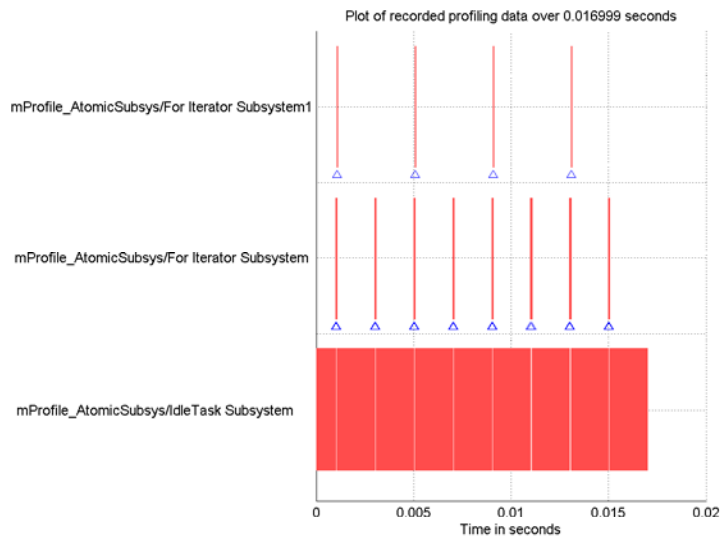

Execution Profiling during PIL Simulation

You can use Execution Profiler during processor-in-the-loop (PIL) simulation to measure CPU utilization of each synchronous task. During the PIL simulation, Execution Profiler stores this execution profile data in an `coder.profile.ExecutionTime` object, located in the MATLAB workspace. After halting the PIL simulation, you can view and analyze this execution profile data.

Feature Support

For execution profiling during PIL simulation, you can use IDE projects (**Build format = Project**) or makefiles (**Build format = Makefile**).

With IDE projects, you can use the following IDEs:

- Analog Devices VisualDSP++
- Eclipse IDE
- Green Hills MULTI

- Texas Instruments Code Composer Studio 3.3

With makefiles, you can use the targets described in “Supported Tool Chains in Embedded Coder” on page 35-22

During processor-in-the-loop (PIL) simulation, you can profile by synchronous tasks.

Gathering Execution Profile Data

To gather execution profile data during PIL simulation:

- 1** Configure a model for PIL simulation, as described in “Processor-in-the-Loop (PIL) Simulation” on page 36-2.
- 2** In your model, select **Simulation > Model Configuration Parameters**.
- 3** In the Configuration Parameters dialog, select **Code Generation**, and then **Verification**.
- 4** Select the **Measure task execution time** check box.
- 5** Provide a valid MATLAB variable name in the **Workspace** edit box. The software uses this name when it creates the `coder.profile.ExecutionTime` object.
- 6** Click **OK** to close the Configuration Parameters.
- 7** Run the PIL simulation, as described in “Processor-in-the-Loop (PIL) Simulation” on page 36-2.

The software creates the `coder.profile.ExecutionTime` object and stores the execution profile data in it.

- 8** Halt the PIL simulation.

Analyzing the Execution Profile Data

After halting the PIL simulation, you can view or analyze the data in the `coder.profile.ExecutionTime` object.

Depending on the target, the execution profile data is measured in seconds or timer ticks.

Targets	Units
Texas Instruments C2000, C5000, and C6000 processors with Code Composer Studio IDE	Seconds
Texas Instruments C6000 processors running DSP/BIOS with Code Composer Studio IDE	Timer Ticks
Analog Devices Blackfin, SHARC, and TigerSHARC processors with VisualDSP++ IDE	Timer Ticks
Freescale™ MPC74xx, Renesas V850, ARM, and Analog Devices Blackfin processors with Green Hills MULTI IDE	Timer Ticks
ARM processors running Wind River VxWorks	Timer Ticks

The `coder.profile.ExecutionTime` class has property `TimerTicksPerSecond` for getting and setting the data units. You can use this property on the execution profile data object after halting the PIL simulation. When the data unit is timer ticks, using the `TimerTicksPerSecond` property converts the data units to seconds.

Stack Profiling for Embedded Targets

In this section...

“Feature Support” on page 36-28

“What is Stack Profiling?” on page 36-28

“Profiling System Stack Use” on page 36-30

Feature Support

Stack profiling is supported on embedded targets, except those running an operating system or RTOS.

Stack profiling is not supported on desktop targets, which are a capability of Simulink Coder.

Execution profiling during standalone execution requires IDE projects (**Build format** = `Project`), which is supported with the following IDEs:

- Analog Devices VisualDSP++
- Eclipse IDE
- Green Hills MULTI
- Texas Instruments Code Composer Studio 3.3

Execution profiling during standalone execution is not supported when using makefiles (**Build format** = `Makefile`).

What is Stack Profiling?

The coder product enables you to determine how your application uses the processor system stack. Using the `profile` method, you can initialize and test the size and usage of the stack. This information can help you optimize both the size of the stack and how your code uses the stack.

To provide stack profiling, `profile` writes a known pattern to the addresses in the stack. After you run your application for a while, and then stop your application, `profile` examines the contents of the stack addresses. `profile`

counts each address that does not contains the known pattern as used. The total number of address that have been used, compared to the total number of addresses you allocated, becomes the stack usage profile. This profile process does not tell you how often an address was changed by your application.

You can profile the stack with both the manually written code in a project and the code you generate from a model.

When you use `profile` to initialize and test the stack operation, the software returns a report that contains information about stack size, usage, addresses, and direction. With this information, you can modify your code to use the stack efficiently. The following program listing shows the stack usage results from running an application on a simulator.

```
profile(IDE_Obj, 'stack', 'report')
```

Maximum stack usage:

System Stack: 532/1024 (51.95%) MAUs used.

```

        name: System Stack
    startAddress: [512    0]
    endAddress: [1535   0]
    stackSize: 1024 MAUs
growthDirection: ascending
```

The following table describes the entries in the report:

Report Entry	Units	Description
System Stack	Minimum Addressable Unit (MAU)	Maximum number of MAUs used and the total MAUs allocated for the stack.
name	String for the stack name	Lists the name assigned to the stack.

Report Entry	Units	Description
startAddress	Decimal address and page	Lists the address of the stack start and the memory page.
endAddress	Decimal address and page	Lists the address of the end of the stack and the memory page.
stackSize	Addresses	Reports number of address locations, in MAUs, allocated for the stack.
growthDirection	Not applicable	Reports whether the stack grows from the lower address to the higher address (ascending) or from higher to lower (descending).

Profiling System Stack Use

To profile the system stack operation, perform these tasks in order:

- 1** Load an application.
- 2** Set up the stack to enable profiling.
- 3** Run your application.
- 4** Request the stack profile information.

Follow these steps to profile the stack as your application interacts with it. This particular example uses Texas Instruments Code Composer Studio 3.3. However, you can generalize from this example to another supported IDE.

- 1** Load the application to profile.

- 2 Use the `profile` method with the **setup** input keyword to initialize the stack to a known state.

```
profile(IDE_Obj, 'stack', 'setup')
```

With the **setup** input argument, `profile` writes a known pattern into the addresses that compose the stack.

- 3 Run your application.
- 4 Stop your running application. Stack use results gathered from an application that is running may be inaccurate.
- 5 Use the `profile` method to capture and view the results of profiling the stack.

```
profile(IDE_Obj, 'stack', 'report')
```

The following example shows how to set up and profile the stack. The IDE link handle object, `IDE_Obj`, must exist in your MATLAB workspace and your application must be loaded on your processor. This example comes from a TI C6713 simulator.

```
profile(IDE_Obj, 'stack', 'setup') % Set up processor stack
%by write A5 to the stack addresses.
```

Maximum stack usage:

System Stack: 0/1024 (0%) MAUs used.

```
      name: System Stack
startAddress: [512   0]
endAddress: [1535   0]
      stackSize: 1024 MAUs
growthDirection: ascending
```

```
run(IDE_Obj)
halt(IDE_Obj)
profile(IDE_Obj, 'stack', 'report') % Request stack use report.
```

Maximum stack usage:

System Stack: 356/1024 (34.77%) MAUs used.

```
      name: System Stack
startAddress: [512  0]
endAddress: [1535  0]
      stackSize: 1024 MAUs
growthDirection: ascending
```

Processor-Specific Optimizations for Embedded Targets

Code Replacement Library (CRL)

In this section...

“About Code Replacement Libraries and Optimization” on page 37-2

“Using a Processor-Specific Code Replacement Library to Optimize Code” on page 37-4

“Process of Determining Optimization Effects Using Real-Time Profiling Capability” on page 37-4

“Reviewing Processor-Specific Code Replacement Library Changes in Generated Code” on page 37-5

“Creating Your Own Code Replacement Library” on page 37-8

“Reviewing Code Replacement Library Operators and Functions” on page 37-8

“Tips and Limitations” on page 37-10

About Code Replacement Libraries and Optimization

A *Code Replacement Library* is a set of one or more function tables that define processor- and compiler-specific implementations of functions and arithmetic operators. The code generation process uses these tables when it generates code from your Simulink model.

The coder product registers processor-specific Code Replacement Libraries during installation. To use one of the libraries, select the set of tables that correspond to functions implemented by intrinsics or assembly code for your processor from the **Code Replacement Library** list in the model Configuration Parameters. To do this, complete the following steps:

- 1** In your model, select **Simulation > Model Configuration Parameters**.
- 2** In the Configuration Parameters dialog, select **Code Generation and Interface**.
- 3** Set the **Code Replacement Library** parameter to the right library for your processor.

After you select the processor-specific library, the model build process uses the library contents to optimize generated code for that processor. The generated code includes processor-specific implementations for `sum`, `sub`, `mult`, `div`, and various functions, such as `tan` or `abs`, instead of the default ANSI C instructions and functions. The optimized code enables your application to run more efficiently and quickly, and in many cases, reduces the size of the code. For more information about Code Replacement Libraries, refer to “Introduction to Code Replacement Libraries” on page 23-2 .

For a list of available CRLs, see “Reviewing Code Replacement Library Operators and Functions” on page 37-8

Code Generation Using the Code Replacement Library

The build process begins by converting your model and its configuration set to an intermediate form that reflects the blocks and configurations in the model. Then the code generation phase starts.

During code generation for your model, the following process occurs:

- 1** Code generation encounters a call site for a function or arithmetic operator and creates and partially populates a Code Replacement Library entry object.
- 2** The entry object queries the Code Replacement Library database for an equivalent math function or operator. The information provided by the code generation process for the entry object includes the function or operator key, and the conceptual argument list.
- 3** The code generation process passes the Code Replacement Library entry object to the Code Replacement Library.
- 4** If a matching table entry is available in the Code Replacement Library, the query returns a fully-populated Code Replacement Library entry to the call site, including the implementation function name, argument list, and build information
- 5** The code generation process uses the returned information to generate code.

Within the Code Replacement Library that you select for your model, the software searches the tables that comprise the library. The search occurs in

the order in which the tables appear in either the Code Replacement Viewer or the **Code Replacement Library** tool tip. For each table searched, if the search finds multiple matches for a Code Replacement Library entry object, priority level determines the match to return. The search returns the higher-priority (lower-numbered) entry.

For more information about Code Replacement Libraries in the build process, refer to “Introduction to Code Replacement Libraries” on page 23-2.

Using a Processor-Specific Code Replacement Library to Optimize Code

Perform the following steps to select the Code Replacement Library for your processor:

- 1** Select **Simulation > Model Configuration Parameters** from the model menu bar. The Configuration Parameters dialog for your model opens.
- 2** In the Configuration Parameters dialog, select the **Code Generation** pane.
- 3** Use **Browse** to select `idmlink_ert.tlc` as the **System target file**.
- 4** From the list of panes under **Code Generation**, choose **Interface**.
- 5** On the **Code Replacement Library** list, select the processor family that matches your processor. Then, click **OK** to save your changes and close the dialog.

With the Code Replacement Library selected, your generated code uses the specific functions in the library for your processor.

To stop using a processor-specific Code Replacement Library, open the Interface pane in the model Configuration Parameters. Then, select the C89/C90 (ANSI) library from the **Code Replacement Library** list.

Process of Determining Optimization Effects Using Real-Time Profiling Capability

You can use the real-time profiling capability to examine the results of applying the processor-specific library functions and operators to your

generated code. After you select a processor-specific Code Replacement Library, use the real-time execution profiling capability to examine the change in program execution time.

Use the following process to evaluate the effects of applying a processor-specific Code Replacement Library when you generate code:

- 1** Enable real-time profiling in your model. Refer to “Execution Profiling for Embedded Targets” on page 36-21.
- 2** Generate code for your project using the default Code Replacement Library C89/C90 ANSI.
- 3** Profile the code, and save the report.
- 4** Rebuild your project using a processor-specific Code Replacement Library instead of the C89/C90 ANSI library.
- 5** Profile the code, and save the second report.
- 6** Compare the profile report from running your application with the processor-specific library selected to the profile results with the ANSI library selected in the first report.

For an example of verifying the code optimization, search the product help for the "Optimizing Embedded Code via Code Replacement Library" and select the example that matches your IDE.

Reviewing Processor-Specific Code Replacement Library Changes in Generated Code

Use one of the following techniques or tools to see the Code Replacement Library elements where they appear in the generated code:

- “Reviewing Code Manually” on page 37-6.
- “Using Model-to-Code Tracing” on page 37-6 to navigate from blocks in your model to the code generated from the block.

- “Using a File Differencing Scheme” on page 37-7 to compare projects that you generate before and after you select a processor-specific Code Replacement Library.

Reviewing Code Manually

To see where the generated code uses Code Replacement Library replacements, review the file *modelName.c*. Look for code similar to the following examples.

For example, with CCS:

```
codeopt_tf1_B.Sum6[j] = ldexp((real_T)Sum[j], -11) + ldexp((real_T)
    c62x_mul_s32_s32_s32_sr_sat(codeopt_tf1_P.Gain5_Gain, UnitDelay[j], 6),
```

For example, with MULTI:

```
j = mul_s32_s32_s32_sr6_sat(codeopt_tf1_P.Gain1_Gain, rtb_SineWave[i]);
    tmp_0 = mul_s32_s32_s32_sr6_sat(codeopt_tf1_P.Gain2_Gain, rtb_UnitDelay[i]);
    tmp_1 = j + tmp_0;
```

For example, with VisualDSP++:

```
codeopt_tf1_B.UnitDelay3[j] = sharc_mul_s32_s32_s32_sr_sat
    (codeopt_tf1_P.Gain4_Gain, codeopt_tf1_B.UnitDelay2[j], 6);
```

The functions shown are the multiply implementation functions registered in the Code Replacement Library. In these examples, the function performs an optimized multiplication operation. Similar functions appear for add, and sub. For more information about the arguments in the function, refer to “Introduction to Code Replacement Libraries” on page 23-2 in the online Help system.

Using Model-to-Code Tracing

You can use the model-to-code report options in the Configuration Parameters to trace the code generated from a block with a Code Replacement Library. After you create your model and select a Code Replacement Library, follow these steps to use the report options to trace the generated code:

- 1 Open the model Configuration Parameters.

- 2** From the list of panes under **Code Generation**, select **Report**.
- 3** In the Report pane, select **Create code generation report** and **Model-to-code**, and then save your changes.
- 4** Press **Ctrl+B** to generate code from your model.

The Code Generation Report window opens on your desktop. For more information about the report, refer to the “Analyze the Generated Code Interface” on page 18-11.

- 5** Use model-to-code highlighting to trace the code generated for each block with a Code Replacement Library applied:
 - Right-click a block in your model and select **C/C++ Code > Navigate To C/C++ Code** from the context menu.
 - Select **Navigate-to-code** to highlight the code generated from the block in the report window.

Inspect the code to see the function or operator implementation in the generated code. For more information, refer to “Trace Code Replacements Generated Using Your CRL” on page 23-195.

If a Code Replacement Library replacement did not occur as you expected, use the techniques described in “Examine and Validate Code Replacement Tables” on page 23-191 to help you determine why the build process did not use the intended function or operator implementation.

Using a File Differencing Scheme

You can also review the Code Replacement Library induced changes in your project by comparing projects that you generate both with and without the processor-specific Code Replacement Library.

- 1** Generate your project with the default C89/C90 ANSI Code Replacement Library. On the Coder Target panel, set **Build action** to **Create_Project**, **Archive_Library**, or **Build**.
- 2** Save the project to a new name—*newproject1*.

- 3** Go back to the Configuration Parameters for your model, and select a Code Replacement Library right for your processor.
- 4** Regenerate your project.
- 5** Save the project with a new name—*newproject2*
- 6** Compare the contents of the *modelName.c* files from *newproject1* and *newproject2*. The differences between the files show the Code Replacement Library induced code changes.

Creating Your Own Code Replacement Library

For details about creating your own library, refer to the following sections in your Embedded Coder documentation:

- “Introduction to Code Replacement Libraries” on page 23-2
- “Create Code Replacement Tables” on page 23-18
- “Examine and Validate Code Replacement Tables” on page 23-191

Reviewing Code Replacement Library Operators and Functions

Embedded Coder software provides the Code Replacement Viewer to enable you to review the arithmetic operators and functions registered in Code Replacement Library tables.

To open the viewer, enter the following command at the MATLAB prompt.

```
RTW.viewTf1
```

For details about using the Code Replacement Viewer, refer to “Selecting and Viewing Code Replacement Libraries” in the online Help system.

At this time, the following Code Replacement Libraries are available:

- C89/C90 (ANSI)
- C99 (ISO)
- GNU99 (GNU)

- C++ (ISO)
- ADI BF53x (ISO)
- ADI BF52x
- ADI BF53x
- ADI SHARC (ISO)
- ADI SHARC
- ADI TigerSHARC
- GCC ARM9
- GCC ARM9E
- GCC ARM10
- GCC ARM11
- GCC ARM Cortex-M3
- GCC ARM Cortex-R4
- GCC ARM Cortex-A5
- GCC ARM Cortex-A8
- GCC ARM Cortex-A9
- MULTI BF53x
- MULTI ARM9
- MULTI ARM9E
- MULTI ARM10
- MULTI ARM11
- TI C28x (ISO)
- TI C28x
- TI C55x (ISO)
- TI C55x
- TI C62x (ISO)
- TI C62x

- TI C64x
- TI C64x+
- TI C67x
- TI C672x
- TI C674x
- Intel IPP (ANSI)
- Intel IPP (ISO)
- Intel IPP/SSE (GNU)
- XPC_BLAS

Tips and Limitations

Intel IPP/SSE (GNU) Works With GCC

The Intel IPP/SSE (GNU) CRL is intended for use with GCC compiler. If used with other compilers, the code generated for your model may not compile.

Working with Analog Devices VisualDSP++ IDE

- “Install Support for Analog Devices DSPs” on page 38-2
- “Getting Started” on page 38-4
- “IDE Automation Interface” on page 38-9
- “IDE Project Generator” on page 38-32
- “Reported Limitations and Tips” on page 38-40

Install Support for Analog Devices DSPs

You can add support for Analog Devices VisualDSP++ DSPs to the Embedded Coder product, using the following process.

After completing this process, you can use Embedded Coder software to automatically generate and build code with Analog Devices VisualDSP++ IDE.

Using this installation process, you download and install the following items on your host computer:

- Related Embedded Coder software features
- Simulink block library called “Embedded Coder Support Package for Analog Devices VisualDSP++ IDE”
- Related examples

For convenience, these instructions occasionally refer to Analog Devices VisualDSP++ IDE as the “IDE”.

- 1** In a MATLAB Command Window, enter `targetinstaller`. This starts the Support Package Installer.
- 2** On the **Install or update support package** screen, select **Internet** and click **Next**.
- 3** Select the Analog Devices DSPs check box, and click **Next**.

The **Installation folder** parameter specifies where Support Package Installer puts the target files. You must have write privileges for the installation folder.

- 4** For the remaining screens, follow the instructions provided by the Support Package Installer. To get additional information about any particular screen, click **Help**.
- 5** When Support Package Installer confirms that the installation is complete, click **Finish**. By default, Support Package Installer displays examples for Analog Devices DSPs.
- 6** If you have not already installed Analog Devices VisualDSP++ IDE, install it now .

- 7 Perform the additional configuration steps described in “Installation and Configuration” on page 38-7.

When you complete this process, you can use Embedded Coder software with Analog Devices VisualDSP++ IDE and Analog Devices DSPs.

Getting Started

In this section...
“Overview” on page 38-4
“Software Structure and Components” on page 38-5
“Software Requirements” on page 38-7
“Installation and Configuration” on page 38-7

Overview

Embedded Coder software provides a connection between MATLAB and the VisualDSP++ IDE to enable you to access the processor from MATLAB. You can, manipulate data on the processor, and manage projects within the IDE, while simultaneously utilizing the MATLAB tools of numerical analysis and simulation. Using Embedded Coder software, you can perform the following tasks, and others related to Model-Based Design:

- Function calls — Write scripts in MATLAB software to execute a function in the VisualDSP++ IDE
- Automation — Write automated tests in MATLAB software to be executed on your processor, including control and verification operations
- Host-Processor Communication — Communicate with the processor directly from MATLAB software, without going to the IDE
- Verification and Validation
 - Load and execute projects into the VisualDSP++ IDE from the MATLAB Command Window
 - Build and compile code, and then use vectors of test data and parameters to test the code
 - Build and compile your code, and then download the code to the processor and execute it
- Design models — Design models and algorithms in MATLAB and Simulink software and run them on the processor

- Generate code— Generate executable code for your processor directly from the models designed in Simulink software, and execute it

Embedded Coder software connects MATLAB software and Simulink software with Analog Devices VisualDSP++ integrated development and debugging environment from Analog Devices. Embedded Coder software enables you to use MATLAB and Simulink software to debug and verify embedded code running on Analog Devices DSPs that VisualDSP++ software supports, such as the Analog Devices Blackfin, Analog Devices SHARC and Analog Devices TigerSHARC processor families.

Embedded Coder software includes an IDE Project Generator component. With the IDE Project Generator component, you can generate a complete project for the VisualDSP++ IDE from your Simulink software models. You use Embedded Coder software to generate generic ANSI C code projects for VisualDSP++ software from models. You can then build and run these projects on Blackfin, SHARC, and TigerSHARC processors.

The following list suggests some of the uses for the capabilities of the software:

- Create test benches in MATLAB and Simulink software for testing your manually written or automatically generated code running on ADI DSPs
- Generate code and project files for VisualDSP++ software from Simulink models for rapid prototyping or deployment of a system or application
- Build, debug, and verify embedded code on ADI DSPs
- Perform processor-in-the-loop (PIL) testing of embedded code

Software Structure and Components

- “IDE Automation Interface” on page 38-6
- “IDE Project Generator” on page 38-6
- “Verification” on page 38-7

Embedded Coder software comprises components—the IDE Automation Interface component, the IDE Project Generator component, and the Verification component. The IDE Automation Interface component enables communication between MATLAB software and Embedded Coder software.

The IDE Project Generator component leverages Simulink software and lets you build models, simulate them, and generate code from the models directly to the processor.

The Verification component offers capabilities that help you use Model-Based Design to validate and verify your projects. With the Verification component, you can simulate algorithms and processes in Simulink models and concurrently on your processor. Comparing the results helps verify the fidelity of your model or algorithm code.

IDE Automation Interface

The IDE Automation Interface component allows you to use Embedded Coder functions and methods to communicate with the VisualDSP++ IDE to perform the following tasks:

- Automate project management
- Debug programs
- Manipulate the data in the processor internal and external memory, and in the registers
- Communicate between the host and processor applications

The Debug Component of IDE Automation Interface includes methods and functions for project automation, debugging, and data manipulation.

IDE Project Generator

The IDE Project Generator component comprises methods that utilize the VisualDSP++ API to create projects in VisualDSP++ software and generate code with Simulink Coder and Embedded Coder software. With the interface, you can do the following:

- Automatic project-based build process — Automatically create and build projects for code generated by Embedded Coder software.
- Custom code generation — Use System Target Files (STF) to generate processor-specific and optimized code.

- Automatic downloading and debugging — Debug generated code in the VisualDSP++ debugger, using either the instruction set simulator or real hardware.
- Create and build projects for VisualDSP++ software from Simulink models — IDE Project Generator uses Simulink Coder or Embedded Coder software to build projects that work with Analog Devices processors.
- Generate custom code using the Configuration Parameters in your model with the system target files `vdspink_ert.tlc` and `vdspink_grt.tlc`.

Verification

Verifying your processes and algorithms is an essential part of developing applications. The components of Embedded Coder software combine to provide the following verification tools for you to apply as you develop your code:

- Processor-in-the-loop simulation (PIL)
- Execution profiling
- Stack profiling

Software Requirements

For detailed information about the software and hardware required to use Embedded Coder software, refer to the Embedded Coder system requirements areas on the MathWorks Web site:

- Requirements for Embedded Coder:
www.mathworks.com/products/ide-link/requirements.html
- Requirements for use with VisualDSP++:
www.mathworks.com/products/ide-link/adi-adaptor.html

Installation and Configuration

- 1 Install VisualDSP++ according to the instructions provided with that software.
- 2 Right-click MATLAB in the Windows Programs menu and select **Run as administrator**.

- 3** Enter `adivdspsetup` on the MATLAB Command Window.
- 4** Use **Browse** to locate the system folder for Analog Devices VisualDSP++. This action registers the Embedded Coder with that IDE.

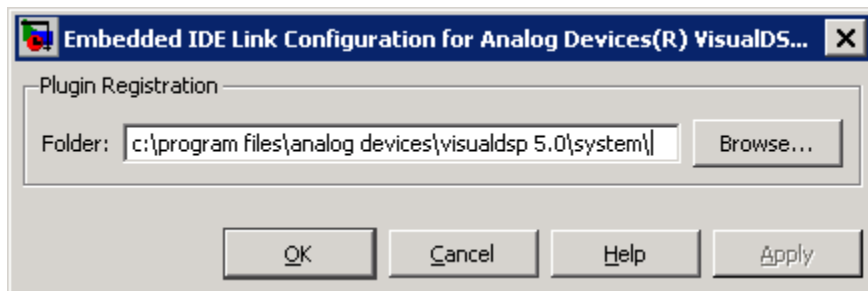

- 5** Confirm that the installation works by entering `IDE_Obj = adivdsp` on the MATLAB Command Window. This action creates an IDE link handle object for VisualDSP++ in MATLAB, and starts VisualDSP++.

IDE Automation Interface

In this section...

- “Getting Started with IDE Automation Interface” on page 38-9
- “Constructing Objects” on page 38-24
- “Properties and Property Values” on page 38-25
- “adivdsp Object Properties” on page 38-28

Getting Started with IDE Automation Interface

- “Introducing the IDE Automation Interface” on page 38-9
- “Interactive Learning” on page 38-12
- “Selecting Your Session and Processor” on page 38-13
- “Querying Objects for VisualDSP++ IDE” on page 38-14
- “Loading Files into VisualDSP++ IDE” on page 38-16
- “Running the Project” on page 38-17
- “Working with Global Variables and Memory” on page 38-18
- “Working with Local Variables and Memory” on page 38-20
- “Closing Files and Projects” on page 38-22
- “Closing the Connections or Cleaning Up VisualDSP++ Software” on page 38-23
- “Summary” on page 38-24

Introducing the IDE Automation Interface

Embedded Coder software provides a connection between MATLAB software and a processor in VisualDSP++ software. You can use objects as a mechanism to control and manipulate a signal processing application using the computational power of MATLAB software. This approach can help you while you debug and develop your application. Another possible use for automation is creating MATLAB scripts that verify and test algorithms that run in their final implementation on your production processor.

Note Before using the functions available with the objects, you must select a session in the VisualDSP++ IDE. The object you create is specific to a designated session in VisualDSP++ IDE.

To get you started using objects for VisualDSP++ software, Embedded Coder software includes an example script `vdspautointtutorial.m`. As you work through this tutorial, you perform the following tasks that step you through creating and using objects for VisualDSP++ IDE.

- 1 Select your session.
- 2 Create and query objects to VisualDSP++ IDE.
- 3 Use MATLAB software to load files into VisualDSP++ software IDE.
- 4 Work with your VisualDSP++ IDE project from MATLAB software.
- 5 Close the connections you opened to VisualDSP++ IDE.

You use these tasks in development work you do with signal processing applications. Thus, the tutorial provided here gives you a working process and best practice for using Embedded Coder software and your signal processing programs to develop programs for a range of Analog Devices processors.

The tutorial covers some methods and functions for Embedded Coder software. The functions listed first do not require an `adivdsp` object. The methods listed require an existing `adivdsp` object before you can use the function syntax.

Functions for Working with VisualDSP++ Software. The following table shows functions that do not require an object.

Function	Description
<code>listsessions</code>	Return information about the boards that VisualDSP++ IDE recognizes as installed on your PC.
<code>adivdsp</code>	Construct an object that refers to a VisualDSP++ IDE session. When you construct the object you specify the session by processor.

Methods for Working with adivdsp Objects in VisualDSP++ Software.

The following table presents some of the methods that require an adivdsp object.

Methods	Description
add	Add a file to a project
address	Return the address and page for an entry in the symbol table in VisualDSP++ IDE
build	Build the project in VisualDSP++ software
cd	Change the working folder
display (IDE Object) "	Display the properties of an object that references a VisualDSP++ software session
halt	Terminate execution of a process running on the processor
info	Return information about the object or session
isrunning	Test whether the processor is executing a process
load	Load a built project to the processor
open	Open a file in the project
read	Retrieve data from memory on the processor
reset	Restore the program counter (PC) to the entry point for the current program
run	Execute the program loaded on the processor
save	Save files or projects
visible	Set whether VisualDSP++ IDE window is visible on the desktop while VisualDSP++ IDE is running
write	Write data to memory on the processor

Running VisualDSP++ Software on Your Desktop – Visibility. When you create an adivdsp object in the tutorial in the next section, Embedded Coder starts VisualDSP++ software in the background.

If VisualDSP++ software is running in the background, it does not appear on your desktop, in your task bar, or on the **Applications** page in the Task Manager. It does appear as a process, `idde.exe`, on the **Processes** tab in Task Manager.

You can make the VisualDSP++ IDE visible with the function `visible`. The function `invisible` returns the status of the IDE—is it visible on your desktop. To close the IDE when it is not visible and MATLAB is not running, use the **Processes** tab in Windows Task Manager and look for `idde.exe`.

If an object that refers to VisualDSP++ software exists when you close VisualDSP++ software, the application does not close. Windows software moves it to the background (it becomes invisible). Only after you clear objects that access VisualDSP++ IDE, or close MATLAB, does closing VisualDSP++ unload the application. You can see if VisualDSP++ IDE is running in the background by checking in the Windows Task Manager. When VisualDSP++ IDE is running, the entry `idde.exe` appears in the **Image Name** list on the **Processes** tab.

Interactive Learning

You have the option of running this tutorial from the MATLAB Command Window or entering the functions as described in the following tutorial sections.

To run the tutorial in MATLAB, click `run vdspautointtutorial`. This command launches the tutorial in an interactive mode where the tutorial program provides prompts and text descriptions to which you respond to move to the next section. The interactive tutorial covers the same information provided by the following tutorial sections. You can view the tutorial MATLAB file used here by clicking `vspautointtutorial.m`.

Note To run the interactive tutorial, you must have at least one session configured in VisualDSP++ software. If you do not yet have a session, use the Analog Devices VisualDSP++ Configurator to create a session to use for this tutorial.

Selecting Your Session and Processor

Embedded Coder IDE requires that you have at least one session available for VisualDSP++ software. To help you select the session to use for this tutorial, and for development work, Embedded Coder software provides a command line tool, called `listsessions`, which prints a list of the available sessions. So that you can use this function in a script, `listsessions` can return a MATLAB structure that you use when you want your script to select a session in the IDE without your help.

Note The session you select is used throughout the tutorial.

- 1 To see a list of the sessions that you can use, enter the following command at the MATLAB prompt:

```
session_list = listsessions
```

MATLAB returns a list that shows the sessions that Embedded Coder IDE recognizes as available in your installation.

```
session_list =  
  
    'ADSP-21060 ADSP-2106x Simulator'  
    'ADSP-21362 ADSP-2136x Simulator'
```

- 2 `listsessions` has a verbose mode that provides further details about the sessions in a cell array. The array contains structures that describe each session—the target type, the platform, and the processor.

```
sessionsinfo = listsessions('verbose');  
  
echo off  
    sessionname: 'ADSP-21362 ADSP-2136x Simulator'  
    targettype: 'ADSP-2136x Family Simulator'  
    platformname: 'ADSP-2136x Simulator'  
    processors: 'ADSP-21362'
```

- 3 Use `adivdsp` to create an object that accesses a session in VisualDSP++ IDE.

```
IDE_Obj = adivdsp('sessionname','ADSP-21362 ADSP-2136x Simulator','procnum',0)
```

Sessionname and procnum are property names that specify the property to set. ADSP-21362 ADSP-2136x Simulator is the session to access, and 0 is the number of the processor to refer to in the session.

When you use adivdsp, you create an object, in this case IDE_Obj, that refers to the session you specify in sessionname.

Querying Objects for VisualDSP++ IDE

In this tutorial section you create the connection between MATLAB and VisualDSP++ IDE. This connection, or object, is a MATLAB object, which for this session you save as variable IDE_Obj. You use function adivdsp to create objects. When you create objects, adivdsp input arguments let you define other object properties, such as the global time-out. Refer to the adivdsp reference information for more about the input arguments.

Use the generated object IDE_Obj to direct actions to your session processor. In the following tasks, IDE_Obj appears in function syntax that interacts with IDE session and the processor: The object IDE_Obj identifies and refers to a specific session. You need to include the object in method syntax you use to access and manipulate a project or files in a session in VisualDSP++ IDE.

- 1 Create an object that refers to your selected session and processor. Enter the following command at the prompt.

```
IDE_Obj = adivdsp('sessionname','ADSP-21362 ADSP-2136x Simulator','procnum',0)
```

If you watch closely, and your machine is not too fast, you see VisualDSP++ software appear briefly when you call adivdsp. If VisualDSP++ was not running before you created the new object, VisualDSP++ software starts and runs in the background.

Usually, you need to interact with VisualDSP++ while you develop your application. The function visible, controls the state of VisualDSP++ software on your desktop. visible accepts Boolean inputs that make VisualDSP++ software either visible on your desktop (input to visible ≥ 1) or invisible on your desktop (input to visible = 0). For this tutorial, you need to interact with the development environment, so use visible to set the IDE visibility to 1.

- 2** To make VisualDSP++ IDE show on your desktop, enter the following command at the prompt:

```
visible(IDE_Obj,1)
```

- 3** Next, enter `display(IDE_Obj)` at the prompt to see the status information.

ADIVDSP Object:

```
Session name      : ADSP-21362 ADSP-2136x Simulator
Processor name    : ADSP-21362
Processor type    : ADSP-21362
Processor number  : 0
Default timeout   : 10.00 secs
```

Embedded Coder software provides methods to read the status of a processor:

- `info` — Return a structure of testable session conditions.
- `display` — Print information about the session and processor.
- `isrunning` — Return the state (running or halted) of the processor.

- 4** Type `procinfo = info(IDE_Obj)`.

The `IDE_Obj` link status information provides data about the hardware, as follows:

```
procinfo =

    procname: 'ADSP-21362'
    proctype: 'ADSP-21362'
    revision: ''
```

- 5** Verify that the processor is running by entering

```
runstatus = isrunning(IDE_Obj)
```

MATLAB responds, indicating that the processor is stopped, as follows:

```
runstatus =
```

```
0
```

Loading Files into VisualDSP++ IDE

In this part of the tutorial, you load the executable code for the CPU in the IDE. Embedded Coder software includes a tutorial project file for VisualDSP++ IDE. Through the next commands in the tutorial, you locate the tutorial project file and load it into VisualDSP++ IDE. The open method directs VisualDSP++ software to load a project file or workspace file.

Note To continue the tutorial, you must identify or create a folder to which you have write access. Embedded Coder software cannot create a folder for you. If you do not have a writable folder, create one in Windows software before you proceed with the rest of this tutorial.

VisualDSP++ software has its own workspace and workspace files that are quite different from MATLAB workspace files and the MATLAB workspace. Remember to monitor both workspaces. The next steps change the working folder to your new writable folder.

- 1 Use `cd` to switch to the writable folder

```
prj_dir = cd('C:\vdsp_demo')
```

where the name and path to the writable folder is a string, such as `C:\vdsp_demo`. Replace `C:\vdsp_demo` with the full path to your folder.

- 2 Change your working folder to the new folder by entering the following command:

```
cd(IDE_Obj,prj_dir)
```

- 3 Next, use the following command to create a new VisualDSP++ software project named `dot_product_c.dpj` in the new folder:

```
new(IDE_Obj, 'debug_demo.dpj')
```

Look in the IDE to verify that your new project exists. Next you need to add source files to your project.

- 4 Add the provided source file—`scalarprod.c` to the project `debug_demo.dpj` using the following command:

```
add(IDE_Obj, [matlabroot '\toolbox\vdspLink\vdspdemos\src\scalarprod.c'])
```

The variable *matlabroot* indicates the root folder of your MATLAB installation. Replace *matlabroot* with the path to MATLAB on your machine. For more information about the MATLAB root folder, refer to *matlabroot* in the MATLAB documentation.

- 5 Open the file in the IDE from MATLAB by issuing the following command to open the file:

```
open(IDE_Obj,[matlabroot '\toolbox\vdspLink\vdspdemos\src\scalarprod.c'])
```

Switch to the IDE to verify that the files are in your project and open.

- 6 Save your project.

```
save(IDE_Obj, 'debug_demo.dpj', 'project')
```

Your IDE project is saved with the name `debug_demo.dpj` in your writable folder. The input string 'project' specifies that you are saving a project file.

Running the Project

After you create `dot_project_c.dpj` in the IDE, you can use Embedded Coder functions to create executable code from the project and load the code to the processor.

The next steps in this tutorial build the executable and download and run it on your processor.

- 1 Use the following build command to build an executable module from the project `dot_product_c.dpj`.

```
build(IDE_Obj,30) %Optional input argument 30 sets time out period to 30 seconds.
```

At the end of the build process, Embedded Coder software returns a value of 1 to indicate that the build succeeded. If the build process returns a 0, the build failed.

```
ans =
```

```
1
```

- 2 To load the new executable to the processor, use `load` with the project file name and the object name. The name of the executable is `debug_demo.dxe`, and it is stored with the project in your writable folder, in a subfolder named `debug`.

```
load(IDE_Obj, 'c:\vdsp_demo\debug\debug_demo.dxe', 30);
```

Embedded Coder software provides methods to control processor execution—`run`, `halt`, and `reset`. To see these methods, use `run` to start the program you loaded on the processor, and then use `halt` to stop the processor.

Try the following methods at the command prompt.

```
run(IDE_Obj)      % Start the program running on the processor.
halt(IDE_Obj)     % Halt the processor.
reset(IDE_Obj)    % Reset the program counter to start of program.
```

Working with Global Variables and Memory

After you load your program on the processor, you can access memory locations and variables. You can then read variables either from the program symbol table or directly from addresses in memory. Three methods—`address`, `read`, and `write`, let you get, read, and write to and from your project and processor.

Start by getting the address of the global variable `v1` from the `debug_demo` project symbol table.

- 1 Enter the following command to retrieve the address for `v1`.

```
address_v1 = address(IDE_Obj, 'v1')
```

```
address_v1 =
```

```
753666      1
```

- 2 Convert the address from decimal format to hexadecimal.

```
dec2hex(address_v1(1))
```

```
ans =
```

B8002

The address of global data array v1 is 0xB8002, which is stored in type 1 memory on the processor

- 3** With the address of v1 saved as `address_v1`, use `read` to return the data from that location. To specify the data type and the number of values to read, add the `datatype ('int32')` and `count (32)` input arguments.

```
value_v1 = read(IDE_Obj, address_v1, 'int32', 32) % Interpret data as 32-bit integers.
```

```
value_v1 =
```

```
Columns 1 through 10
```

```
    -37    -133     31   -104     32     66   -123     19    140    -28
```

```
Columns 11 through 20
```

```
     16     80     -2     83   -243    148     56    163     46     45
```

```
Columns 21 through 30
```

```
  -217    -11   -164     49     -3     99     21    -61    -26    101
```

```
Columns 31 through 32
```

```
  -101    -151
```

- 4** Repeat the read process for another global variable in the project—`v2`. Nest the `address` method inside the `read` method to reduce typing.

```
value_v2 = read(IDE_Obj, address(IDE_Obj, 'v2'), 'int32', 32)
```

```
value_v2 =
```

```
Columns 1 through 10
```

```
    -50     5    -17     28     5     31    -23   -156     68     -5
```

Columns 11 through 20

-220 5 -14 57 214 183 213 40 175 144

Columns 21 through 30

-12 -77 -18 77 130 -39 132 107 52 -59

Columns 31 through 32

127 -117

Working with Local Variables and Memory

If you examine the source files for `debug_demo` in the IDE, you can verify the values for `v1` and `v2` in the source file `scalarprod.c`. You can also use the `address` method to get the addresses of local variables on the stack, after the variable is in scope.

To get the variables in scope (on the stack), you run the program. Adding a breakpoint to the program allows you to read the stack contents when the program stops at the breakpoint. Without the breakpoint, the program runs to completion, and you cannot read the contents of the stack because it does not exist.

Begin the process by adding a breakpoint to the project file `scalarprod.c`:

- 1 Insert a breakpoint on line 100 of program `scalarprod.c` with the following command:

```
insert(IDE_Obj, 'scalarprod.c', 100)
```

- 2 Run the program to add the variable to the stack, and move the program counter to the breakpoint. Add the optional input argument `timeout` sets the time out value to 30s instead of the default 20s value:

```
run(IDE_Obj, 'runtohalt', 30)
```

The program stops at the breakpoint on line 100.

- 3** Read the address of the local variable `result`, and convert it to its hexadecimal equivalent value.

```
address_result = address(IDE_Obj, 'result', 'local')
```

```
address_result =
```

```
    933884         1
```

```
dec2hex(address_result(1))
```

```
ans =
```

```
E3FFC
```

`address` returns 933884 as the location of `result` in memory, in type 1 memory on the processor, stored in the MATLAB variable `address_result`.

- 4** Use the variable `address_result` to get the value stored at that address by issuing the following `read` command:

```
actual_value_result = read(IDE_Obj, address_result, 'int32')
```

```
actual_value_result =
```

```
    18875
```

Verify in the IDE Output Window that 18875 is the value for the dot product.

- 5** Use the following command to remove the breakpoint set on line 100.

```
remove(IDE_Obj, 'scalarprod.c', 100)
```

MATLAB includes a dot product function to use to verify the value in `actual_value_result`. Called `dot`, the function calculates the dot product of two input vectors. In this case, the inputs are vectors `value_v1` and `value_v2`.

Comparing the two results—`expected_value_result` in MATLAB with `actual_value_result` from the processor implementation validates your simulation and implementation. With IDE Automation Interface methods,

you can create MATLAB file scripts to test and verify algorithms in their implementation on a processor.

- 1 Calculate the expected result by performing the dot function with two input vectors.

```
expected_value_result = dot(value_v1, value_v2)
```

```
expected_value_result =
```

```
18875
```

- 2 Test to see if the actual and expected results match.

```
isequal(expected_value_result, actual_value_result)
```

```
ans =
```

```
1
```

- 3 After verifying the result and removing the breakpoint, run the program to completion, and then halt and reset the processor.

```
run(IDE_Obj)
```

```
halt(IDE_Obj)
```

```
reset(IDE_Obj)
```

Closing Files and Projects

You can close files in your projects from the MATLAB Command Window. The method `close` works at the command line to close programs or projects in the IDE through the `adivdsp` object and input keywords that describe the kind of file to close.

To finish this tutorial, close the open documents or files in the IDE, and then close the project `debug_demo.dpj`.

- 1 Close the open files and documents in the IDE. The open files are text files, so use the `text` input argument.

```
close(IDE_Obj, 'all', 'text')
```

2 Now, close the project.

```
close(IDE_Obj, 'debug_demo.dpj', 'project')
```

If you close the VisualDSP++ IDE manually outside of MATLAB, clear the IDE link handle object in MATLAB. For example, in the MATLAB Command Window enter:

```
clear IDE_Obj
```

Note If you have a Project options dialog open, close the Project options dialog before using the `close` or `clear` methods. The dialog prevents the methods from working but does not produce an error message.

Closing the Connections or Cleaning Up VisualDSP++ Software

Objects that you create in Embedded Coder software have connections to VisualDSP++ software. Until you delete these handles, the VisualDSP++ process (`idde.exe` in the Windows Task Manager) remains in memory. Closing MATLAB removes these objects automatically, but there may be times when it helps to delete the handles manually, without quitting MATLAB.

Note When you clear the last `adivdsp` IDE link handle object, Embedded Coder software closes VisualDSP++ software. When it closes the IDE, the link software does not save current projects or files in the IDE, and it does not prompt you to save them. A best practice is to save your projects and files before you clear `adivdsp` objects from your MATLAB workspace.

1 Use the following command to make the IDE invisible if it is visible on your desktop.

```
visible(IDE_Obj,0)
```

2 To delete your connection to VisualDSP++ IDE, use `clear IDE_Obj`.

Summary

During the tutorial you performed the following tasks:

- 1 Selected your session.
- 2 Created and queried objects that refer to a session in Embedded Coder to get information about the session and processor.
- 3 Used MATLAB to load files into VisualDSP++ IDE, and used methods in MATLAB to run that file.
- 4 Accessed variables in the program symbol table and on the processor.
- 5 Used the IDE Automation Interface methods to compare the results of a simulation in MATLAB with the same algorithm running on a processor.
- 6 Closed the files, projects, and connections you opened to VisualDSP++ IDE.

Constructing Objects

When you create a connection to a session in VisualDSP++ software using the `adivdsp` function, you create an object. The object implementation relies on MATLAB object-oriented programming capabilities similar to the objects you find in MATLAB or Filter Design Toolbox.

The discussions in this section apply to the objects in Embedded Coder software. Because `adivdsp` objects use the MATLAB programming techniques, the information about working with the objects, such as how you get or set properties, or use methods, apply to the objects you create in Embedded Coder software.

Like other MATLAB structures, objects in Embedded Coder software have predefined fields referred to as *object properties*.

You specify object property values by one of the following methods:

- Specifying the property values when you create the object
- Creating an object with default property values, and changing these property values later

For examples of setting link properties, refer to “Setting Property Values with set.”

Constructor for adivdsp Objects

The easiest way to create an object is to use the function `adivdsp` to create an object with the default properties. Create an object named `IDE_Obj` referring to a session in VisualDSP++ software by entering the following syntax:

```
IDE_Obj = adivdsp
```

MATLAB responds with a list of the properties of the object `IDE_Obj` you created along with the associated default property values.

ADIVDSP Object:

```
Session name      : ADSP-21362 ADSP-2136x Simulator
Processor name    : ADSP-21362
Processor type    : ADSP-21362
Processor number  : 0
Default timeout   : 10.00 secs
```

The object properties are described in the `adivdsp` documentation.

Note These properties are set to default values when you construct links.

Properties and Property Values

- “Setting and Retrieving Property Values” on page 38-26
- “Setting Property Values Directly at Construction” on page 38-26
- “Setting Property Values with set” on page 38-27
- “Retrieving Properties with get” on page 38-27
- “Direct Property Referencing to Set and Get Values” on page 38-28
- “Overloaded Functions for adivdsp Objects” on page 38-28

Objects in this software have properties associated with them. Each property is assigned a value. You can set the values of most properties, either when

you create the link or by changing the property value later. However, some properties have read-only values. Also, a few property values, such as the board number and the processor to which the link attaches, become read-only after you create the object. You cannot change those after you create your link.

Setting and Retrieving Property Values

You can set `adivdsp` object property values by either of the following methods:

- Directly when you create the link — see “Setting Property Values Directly at Construction”
- By using the `set` function with an existing link — see “Setting Property Values with `set`”

Retrieve Embedded Coder software object property values with the `get` function.

Direct property referencing lets you either set or retrieve property values for `adivdsp` objects.

Setting Property Values Directly at Construction

To set property values directly when you construct an object, include the following entries in the input argument list for the constructor method `adivdsp`:

- A string for the property name to set followed by a comma. Enclose the string in single quotation marks.
- The associated property value. Sometimes this value is also a string.

Include as many property names in the argument list for the object construction command as there are properties to set directly.

Setting Object Property Values at Construction. Suppose that you want to create a link to a session in VisualDSP++ software and set the following object properties:

- Refer to the specified session.
- Connect to the first processor.

- Set the global time-out to 5 s. The default is 10 s.

Set these properties by entering

```
IDE_Obj = adivdsp('sessionname','ADSP-21060 ADSP-2106x Simulator','procnum',0,'timeout',5);
```

The `sessionname`, `procnum`, and `timeout` properties are described in Link Properties, as are the other properties for links.

Setting Property Values with set

After you construct an object, the `set` function lets you modify its property values.

Using the `set` function, you can change the value of a writable object property.

Setting Object Property Values Using set. To set the time-out specification for the link `IDE_Obj` from the previous section, enter the following syntax:

```
set(IDE_Obj,'timeout',8);
```

```
get(IDE_Obj,'timeout');  
ans =
```

```
8
```

The display reflects the changes in the property values.

Retrieving Properties with get

You can use the `get` command to retrieve the value of an object property.

Retrieving Object Property Values Using get. To retrieve the value of the `sessionname` property for `vd2`, and assign it to a variable, enter the following syntax:

```
session = get(vd2,'sessionname')
```

```
session =
```

ADSP-21060 ADSP-2106x Simulator

Direct Property Referencing to Set and Get Values

You can directly set or get property values using MATLAB structure-like referencing. Do this by using a period to access an object property by name, as shown in the following example.

Direct Property Referencing in Links. To reference an object property value directly, perform the following steps:

- 1 Create a link with default values.
- 2 Change its time-out and number of open channels.

```
IDE_Obj = adivdsp;  
IDE_Obj.time = 6;
```

Overloaded Functions for adivdsp Objects

Several methods and functions in Embedded Coder software have the same name as functions in other MathWorks products. These functions behave similarly to their original counterparts, but you apply them to an object. This concept of having functions with the same name operate on different types of objects (or on data) is called *overloading* of functions.

For example, the `set` command is overloaded for objects. After you specify your object by assigning values to its properties, you can apply the methods in this toolbox (such as `address` for reading an address in memory) directly to the variable name you assign to your object. You do not have to specify your object parameters again.

For a complete list of the methods that act on `adivdsp` objects, refer to “Working with Analog Devices VisualDSP++ IDE” in the function reference pages.

adivdsp Object Properties

- “Quick Reference to adivdsp Properties” on page 38-29

- “Details About adivdsp Object Properties” on page 38-30

Embedded Coder software provides links to your processor hardware so you can communicate with processors for which you are developing systems and algorithms. Because Embedded Coder software uses objects to create the links, the parameters you set are called properties and you treat them as properties when you set them, retrieve them, or modify them.

This section details the properties for the objects for VisualDSP++ software. First the section provides tables of the properties, for quick reference. Following the tables, the section offers in-depth descriptions of each property, its name and use, and whether you can set and get the property value associated with the property. Descriptions include a few examples of the property in use.

MATLAB users may find much of this handling of objects familiar. Objects in Embedded Coder software behave like objects in MATLAB and the other object-oriented toolbox products. C++ programmers may already understand the concepts described in this section.

Quick Reference to adivdsp Properties

The following table lists the properties for the links in Embedded Coder software. The second column indicates the object to which the property belongs. Knowing which property belongs to each object tells you how to access the property.

Property Name	User Settable?	Description
sessionname	At construction only	Reports the name of the session in VisualDSP++ IDE that the object references.
procnum	At construction only	Stores the number of the processor in the session. If you have more than one processor, this number identifies the specific processor.
timeout	Yes/default	Contains the global time-out setting for the link.

Some properties are read only. Thus, you cannot set the property value. Other properties, you can change. If the entry in the User Settable column is “At construction only”, you can set the property value only when you create the object. Thereafter it is read only.

Details About `adivdsp` Object Properties

To use the objects for VisualDSP++ interface, set values for the following:

- `sessionname` — Specify the session with which the object interacts.
- `procnum` — Specify the processor in the session. If the board has multiple processors, `procnum` identifies the processor to use.
- `timeout` — Specify the global time-out value. (Optional. Default is 10 s.)

Details of the properties associated with `adivdsp` objects appear in the following sections, listed in alphabetical order by property name.

`procnum`. Property `procnum` identifies the processor referenced by an object for Embedded Coder IDE. Use `procnum` to specify the processor you are working with in the session specified by `sessionname`. The VisualDSP++ Configurator assigns a number to each processor installed in each session. To determine the value of `procnum` for a processor, use `listsessions` or the Configurator.

To identify a processor, you need the `sessionname` and `procnum` values. For sessions with one processor, `procnum` equals 0. VisualDSP++ IDE numbers the processors on multiprocessor boards sequentially from 0 to the total number of processors. For example, on a board with four processors, the processors are numbered 0, 1, 2, and 3.

The `adivdsp` object only supports connecting to processor 0.

`sessionname`. Property `sessionname` identifies the session referenced by a Embedded Coder software. When you create an object, you use `sessionname` to specify the session you are intending to interact with. To get the value for `sessionname`, use `listsessions` or the Analog Devices VisualDSP++ Configurator. The Configurator utility assigns the name for each session available on your system.

timeout. Property `timeout` specifies how long VisualDSP++ software waits for a process to finish. You set the global time-out when you create an object for a session in VisualDSP++ IDE. The default global time-out value 10 s. The following example shows the `timeout` value for object `vd2`.

```
display(vd2)
```

```
ADIVDSP Object:
```

```
Session name      : ADSP-21060 ADSP-2106x Simulator  
Processor name    : ADSP-21060  
Processor type    : ADSP-21060  
Processor number  : 0  
Default timeout   : 10.00 secs
```

IDE Project Generator

In this section...

“Introducing IDE Project Generator” on page 38-32

“Generate an IDE Project” on page 38-33

“Model Reference” on page 38-36

Introducing IDE Project Generator

IDE Project Generator provides the following features for developing projects and generating code:

- Automated project building for VisualDSP++ software that lets you create VisualDSP++ software projects from code generated by Simulink Coder and Embedded Coder software. IDE Project Generator populates projects in the VisualDSP++ software development environment.
- Blocks in the library `idelinklib_adivdsp` for controlling the scheduling and timing in generated code.
- Highly configurable code generation using model Configuration Parameters.
- Capability to use one of two system target files to generate code specific to your processor.
- Highly configurable project build process.
- Automatic downloading and running of your generated projects on your processor.

To configure your Simulink software models to use the IDE Project Generator component, do one or both of the following tasks:

- Configure your model for your IDE, tool chain, and target hardware, as described in “Configure Target Hardware Resources” on page 35-3.
- To use the asynchronous scheduler capability in Embedded Coder software, add one or more hardware interrupt blocks or idle task block from the `idelinklib_adivdsp` library.

The following sections describe the blockset and the blocks in it, the scheduler, and the IDE Project Generator component.

Generate an IDE Project

- “Building the Model” on page 38-33
- “Specifying Simulink Configuration Parameters for Your Model” on page 38-34

In this tutorial you build a model and generate a project from the model into VisualDSP++ IDE.

Note The model shows project generation only. You cannot build and run the model on your processor without additional blocks.

To generate a project from a model, complete the following tasks:

- 1** Use Simulink blocks, DSP System Toolbox blocks, and blocks from other blocksets to create the model application.
- 2** Configure your model for your IDE, tool chain, and target hardware, as described in “Configure Target Hardware Resources” on page 35-3.
- 3** Generate your project.
- 4** Review your project in VisualDSP++ software.

Building the Model

To build a model, follow these steps:

- 1** Open the Simulink Library Browser.
- 2** Use Simulink blocks to create a model, or open one of the example models for Analog Devices VisualDSP++.
- 3** Name and save your model before continuing.

Specifying Simulink Configuration Parameters for Your Model

The following sections describe how to configure the build and run parameters for your model. Generating a project, or building and running a model on the processor, starts with configuring model options in the Configuration Parameters dialog in Simulink software.

Setting Solver Options. After you have designed and implemented your digital signal processing model in Simulink software, complete the following steps to set the Configuration Parameters for the model:

- 1 Open the Configuration Parameters dialog and set the right options on the **Solver** category for your model and for Embedded Coder software.
 - Set **Start time** to 0.0 and **Stop time** to `inf` (model runs without stopping). If you set a stop time, your generated code does not honor the setting. Set this to `inf` for completeness.
 - Under **Solver options**, set **Type** to `fixed-step` and set **Solver** to `discrete (no continuous states)`. For PIL, set **Type** and **Solver** to any setting.
 - For **Fixed step size (fundamental sample time)**, enter `Auto`, and set **Tasking mode for periodic sample times** to `SingleTasking`.

Note Generated code does not honor Simulink stop time from the simulation. Stop time is interpreted as `inf`. To implement a stop in generated code, you must put a Stop Simulation block in your model.

Ignore the **Data Import/Export**, **Diagnostics**, and **Optimization** panes in the Configuration Parameters dialog. The default settings are right for your new model.

Setting Code Generation Options. To configure Simulink Coder software to use the right processor files and to compile and run your model executable file, set the options in the **Code Generation** pane in the Configuration Parameters dialog. Follow these steps to set the Simulink Coder software options to generate code tailored for your DSP:

- 1 In the Configuration Parameters dialog, select the **Code Generation** pane.

- 2 In **Target selection**, click **Browse** to select the system target file for Analog Devices processors—`vdsplink_grt.tlc`. It may already be the selected target file.

Clicking **Browse** opens the **System Target File Browser** to allow you to changes the system target file.

- 3 On the **System Target File Browser**, select the system target file `vdsplink_grt.tlc`, and click **OK** to close the browser.

Setting Coder Target Options. Set the Coder Target options for your Analog Devices processor.

- 1 In the Configuration Parameters dialog, select the **Hardware Implementation** pane.
- 2 Verify that **Device type** matches the target hardware, such as ADI Blackfin, ADI SHARC, or ADI TigerSHARC.
- 3 Under **Code Generation**, select **Coder Target** pane.
- 4 Set the following **Run-Time** options:
 - **Build action:** `Create_project`.
 - **Interrupt overrun notification method:** `Print_message`.
- 5 Set the following options in the dialog under **Vendor Tool Chain**:
 - Set **Configuration** to `Custom`.
 - Set **Compiler options string** and **Linker options string** to blank.

You have configured the Code Generation pane settings to generate a project for your processor. A few of the panes under the node for the Code Generation pane, such as **Comments** and **Symbols** do not require configuration.

For your new model, the default values for the options in these panes are right. For other models you develop, you may want to set the options in these panes to provide information during the build and to run TLC debugging when you generate code. Refer to your Simulink and Simulink Coder documentation for more information about setting the Configuration Parameters.

Creating Your Project. After you set the Configuration Parameters and configure Simulink Coder software to create the files you need, you direct the software to create your project:

- 1 Click **OK** to close the Configuration Parameters dialog.
- 2 project into to generate your project into VisualDSP++ IDE.

When you perform an incremental build with **Build action** set to `Create_project`, the automatic build process starts VisualDSP++ software and populates a new project in the development environment.

Model Reference

- “How Model Reference Works” on page 38-36
- “Using Model Reference” on page 38-38
- “Configuring Targets to Use Model Reference” on page 38-39

Model reference lets your model include other models as modular components. This technique is useful because it provides the following capabilities:

- Simplifies working with large models by letting you build large models from smaller ones, or even large ones.
- Lets you generate code for the modules in the model, and later, regenerate code for modules that change.
- Lets you develop the modules independently.
- Lets you reuse modules and models by reference, rather than including the model or module multiple times in your model. Also, multiple models can refer to the same model or module.

Your Simulink Coder documentation provides much more information about model reference.

How Model Reference Works

Model reference behaves differently in simulation and in code generation. For this discussion, you need to know the following terms:

- The *top-model* is the root model block or model. It refers to other blocks or models. In the model hierarchy, this is the topmost model.
- *Referenced models* are blocks or models that other models reference, such as models the top-model refers to. Models or blocks below the top-model in the hierarchy are reference models.

The following sections describe briefly how model reference works. More details are available in your Simulink Coder documentation in the online Help system.

Model Reference in Simulation. When you simulate the top-model, Simulink Coder software detects that your model contains referenced models. Simulink software generates code for the referenced models and uses the generated code to build shared library files for updating the model diagram and simulation. It also creates an executable (.mex file) for each reference model that is used to simulate the top-model.

When you rebuild reference models for simulations or when you run or update a simulation, Simulink software rebuilds the model reference files. Whether reference files or models are rebuilt depends on:

- Whether and how you change the models.
- The **Rebuild** parameter on the **Model Reference** pane in the Configuration Parameters dialog.

Model Reference in Code Generation. Simulink Coder software requires executables to generate code from models. If you have not simulated your model at least once, Simulink Coder software creates a .mex file for simulation.

Next, for each referenced model, the code generation process calls `make_rtw` and builds each referenced model. This build process creates a library file for each of the referenced models in your model.

After building the referenced models, the software calls `make_rtw` on the top-model, linking to the library files it created for the associated referenced models.

Using Model Reference

With few limitations or restrictions, Embedded Coder software provides full support for generating code from models that use model reference.

Build Action Setting. The most important requirement for using model reference with the Analog Devices targets is to set the **Build action** for Model blocks used by the simulation to `Archive_library`.

To set the build action, perform the following steps:

- 1 Open your model.
- 2 Select **Simulation > Model Configuration Parameters** from the model menus.
- 3 In the Configuration Parameters dialog, expand the node for the **Code Generation** pane and select the **Coder Target** pane.
- 4 In the right pane, under **Run-Time**, select `Archive_library` from the **Build action** list.

If your top-model uses a reference model that does not have the build action set to `Archive_library`, the build process automatically changes the build action to `Archive_library` and issues a warning about the change.

Selecting the `Archive_library` setting removes the following options from the dialog:

- **Interrupt overrun notification method**
- **Compiler options string**
- **Linker options string**
- **System stack size (MAUs)**
- **Profile real-time execution**

Other Block Limitations. Model reference with Embedded Coder software does not allow you to use:

- Noninlined S-functions

- Memory Allocate block
- Memory Copy block
- Idle Task block
- Hardware Interrupt block for SHARC, TigerSHARC, or Blackfin DSPs

Configuring Targets to Use Model Reference

When you create models to use in Model Referencing, keep in mind the following considerations:

- Your model must use a system target file derived from the ERT or GRT targets files.
- When you generate code from a model that references other models, you must configure the top-level model and the referenced models for the same system target file.
- Simulink Coder software builds and Embedded Coder software do not support External mode in model reference. If you select the External mode option, it is ignored during code generation.
- Your TMF must support use of the shared utilities folder, as described in Supporting Shared Utility Directories in the Build Process in the Simulink Coder documentation.

To use an existing processor, or a new processor, with Model Reference, set the `ModelReferenceCompliant` flag for the processor. For information about setting this option, refer to `ModelReferenceCompliant` in the online Help system.

If you start with a model that was created prior to MATLAB release R14SP3, use the following command to set the `ModelReferenceCompliant` flag to `On` to make your model compatible with model reference:

```
set_param(bdroot, 'ModelReferenceCompliant', 'on')
```

Code that you generate from Simulink software models by using Embedded Coder software automatically include the model reference capability. You do not need to set the flag.

Reported Limitations and Tips

Reported Issues

Some long-standing issues apply to the Embedded Coder software. When you are using `adivdsp` objects and methods to work with VisualDSP++ software and supported hardware or simulators, recall the information in this section.

The latest issues in the list appear at the bottom. PIL means “processor-in-the-loop” and is similar to hardware-in-the-loop operations.

Using 64-bit Symbols in a 64-bit Memory Section on SHARC Processors

VisualDSP++ compiler design prevents Embedded Coder from generating code that accesses 64-bit memory locations accurately. To avoid unexpected results, do not allocate 64-bit data or symbols to 64-bit memory locations on SHARC processors.

When 64-bit data is in 64-bit memory, the compiler generates code that accesses the 64-bit locations as two 32-bit values. Thus, the code does not read and write the 64-bit data accurately. It reads or writes every other 32-bit location, returning or writing the wrong values and possibly exceeding the allocated memory.

Refer to pp. 5-33 in the *ADSP-2136x SHARC Processor Programming Reference, revision 1.0* for a description of how the compiler treats 64-bit (long word) data values.

Working with Eclipse IDE

- “Installing Third-Party Software for Eclipse” on page 39-2
- “Configuring Your MathWorks Software to Work with Eclipse” on page 39-10
- “Troubleshooting with Eclipse IDE” on page 39-15

Note To use the coder product with Eclipse IDE, complete the steps in “Installing Third-Party Software for Eclipse” on page 39-2 and “Configuring Your MathWorks Software to Work with Eclipse” on page 39-10

Installing Third-Party Software for Eclipse

In this section...
“Tested Software Versions” on page 39-2
“Installing Oracle Java Runtime Environment (JRE)” on page 39-3
“Installing Eclipse IDE for C/C++ Developers” on page 39-5
“Verifying the GNU Tool Chain on Linux Host” on page 39-6
“Installing the GNU Tool Chain on Windows” on page 39-7

Tested Software Versions

MathWorks has tested the coder product with the specific software versions listed in the following tables.

Required for both platforms	Tested Versions
Oracle® Java Runtime Environment (JRE)	JRE 6.0 (Java 1.6.x)
Eclipse IDE for C/C++ Developers package, which includes the CDT feature	Ganymede (Eclipse 3.4)
CDT (If CDT is installed separately from Eclipse IDE for C/C++ Developers package, match CDT version with Eclipse version.)	CDT 5.0

Linux: Additional Software Required	Tested Versions
GNU GCC (compiler)	GCC 4.4
GNU as (assembler — part of the GNU binutils package)	as 2.18

Linux: Additional Software Required	Tested Versions
GNU ar (archiver — part of the GNU binutils package)	ar 2.18
GNU GDB (debugger)	GDB 6.8.x
GNU make	make 3.81

Windows: Additional Software Required	Tested Versions
MinGW	5.1.x
GDB	GDB 6.3.x
MSYS	1.0.11

You can try untested versions and combinations of third-party software at your own risk.

For the most current information about using the coder product software with Eclipse IDE, see: www.mathworks.com/products/embedded-coder/eclipse-adaptor.html

Installing Oracle Java Runtime Environment (JRE)

To install the JRE, complete the following steps:

- 1 At your Windows or Linux command prompt, enter:

```
java -version
```

If Java is present, the command line responds with the version information, as this example shows.

```
$ java -version
java version "1.6.0_17"
Java(TM) SE Runtime Environment (build 1.6.0_17-b04)
$
```

- 2 If Java is missing or the version is lower than 1.6.x, download and install JRE 6.0 from <http://www.java.com>.

- 3 Get the path of the Java JRE by entering `which java` on the command line.
- 4 Set the PATH system variable in your operating system.

For example, in Windows 7:

- a Press the Windows key and search for “System environment variables” and open “Edit the system environment variables”.
- b In System Properties, to go **Advanced** and click **Environment Variables**.
- c In the **System variables**, locate and select “Path”.
- d Click the **Edit** button and add the path of the Java JRE to the **Variable value**.

For example, add `C:\Program Files\Java\jre6\bin;` to the **Variable value**.

- e Click OK to save your changes.

For example, with Linux:

- a Open a startup file, such as `~/ .cshrc`.
- b Add the path of the Java JRE to the PATH variable.

For example, on a 64-bit Linux host computer, if you are using `csch` or `tcsh`, enter:

```
setenv PATH $PATH:/local/MATLAB/R2011b/sys/java/jre/glnxa64/jre/bin
```

For example, on a 64-bit Linux host computer, if you are using `sh`, `ksh`, or `bash`, enter:

```
PATH=$PATH:/local/MATLAB/R2011b/sys/java/jre/glnxa64/jre/bin ; export PATH
```

- c Save your changes and close the file.

For more information, see <http://www.java.com/en/download/help/path.xml>.

- 5 Verify that Java is working by entering `java -version` again or by visiting <http://www.java.com/en/download/help/testvm.xml>.

Installing Eclipse IDE for C/C++ Developers

Note The following instructions are based on Eclipse 3.4 (Ganymede). More recent versions of the Eclipse IDE can have different appearances, menus, or software package names.

The Eclipse IDE for C/C++ Developers package includes the Eclipse IDE and the C/C++ Development Tools (CDT). To install Eclipse IDE for C/C++ Developers package, complete the following steps:

- 1** Download the Ganymede SR2 zip file for Eclipse IDE for C/C++ Developers, from <http://www.eclipse.org/downloads/packages/release/ganymede/sr2>.
- 2** Extract the Eclipse files to a permanent location, such as `C:\eclipse\` and create a desktop shortcut to `eclipse.exe`.
- 3** Start Eclipse, and select **Help > Software Updates**.
- 4** Look under the **Installed Software** tab, and verify that Eclipse has the following three CDT software packages.
 - Eclipse C/C++ Development Platform
 - Eclipse C/C++ Development Tools
 - Mylin Bridge: C/C++ Development

If you have a previous Eclipse installation that does not include CDT, complete the following steps:

- 1** In Eclipse, select **Help > Software Updates**.
- 2** Click the **Available Software** tab.
- 3** Click **Ganymede Update Site**.
- 4** Select **C and C++ Development**, and click **Install**.
- 5** When the installation process completes, click the **Installed Software** tab, and verify that you have CDT.

Verifying the GNU Tool Chain on Linux Host

Most Linux distributions include the following GNU C/C++ development tools. Eclipse and CDT require these tools to compile code, build projects, and debug applications:

- Assembler (as)
- Archiver (ar)
- compiler and linker (gcc)
- debugger (gdb)
- build utility (make)

Verify that the GNU tools are present and set the tool chain path:

1 On the Linux command line, enter:

- `gcc --version`
- `gdb --version`
- `as --version`
- `ar --version`
- `make --version`

2 Compare the version of each tool with the following list of tested versions:

- gcc 4.4
- as 2.18
- ar 2.18
- gdb 6.8.x
- make 3.81

If you are using Eclipse for targeting embedded Linux, disregard the version numbers in the preceding list.

To install a missing tool or to change the version of the tool, use the software installation manager that comes with your Linux distribution.

Alternatively, visit <http://directory.fsf.org/GNU/> for more information about individual tools. Source files for the tools are available from:

- binutils (includes `as` and `ar`), <http://ftp.gnu.org/gnu/binutils/>
- gcc, <http://ftp.gnu.org/gnu/gcc/>
- gdb, <http://ftp.gnu.org/gnu/gdb/>
- make, <http://ftp.gnu.org/gnu/make/>

- 3** Modify the `PATH` environment using the right commands for your running shell. You can also modify the path environment variable in your login scripts.

If you are using a Bash shell prompt, enter:

```
PATH=my_tool_path:$PATH
```

Where `my_tool_path` is the path to the GNU tool binaries. For example:

```
PATH=/bin:$PATH
```

If you are using a C shell prompt, enter:

```
setenv PATH my_tool_path:$PATH
```

Where `my_tool_path` is the path to the GNU tool binaries. For example:

```
setenv PATH /bin:$PATH
```

Installing the GNU Tool Chain on Windows

Windows typically does not include GNU C/C++ development tools. Eclipse and CDT require these tools to compile code, build projects, and debug applications.

Provide a GNU tool chain for Windows by installing MinGW:

- 1** Open <http://sourceforge.net/projects/mingw/files/>.
- 2** Download and run the latest version of the “Automated MinGW Installer”.

Note The earliest version of MinGW available is more recent than the tested version.

- 3** Start the MinGW installation wizard to perform a default installation.

Perform a default installation until you reach **Select Components**. At that step, select **MSYS Basic System**.

Then, complete the default installation process. Wait for the installation wizard to download, and install additional files from the Internet.

Note If you alter the default installation path, C:/MinGW, do not use spaces in the new path.

Set the PATH environment variable:

- 1** In Windows, right-click **My Computer** or **Computer**, and choose **Properties**.
- 2** Then select **Advanced** or **Advanced system settings**, and click **Environment Variables**.
- 3** Under **System variables**, scroll down to the **Path** variable.
- 4** Select **Path**, and click **Edit**.
- 5** Configure the operating system to the GNU tools when there are multiple paths:
 - a** Add the paths of the MinGW and MSYS bin folders to the beginning of the **Variable value**.
 - b** Use semicolons to separate the paths. For example,
C:\mingw\bin;C:\mingw\msys\1.0\bin;

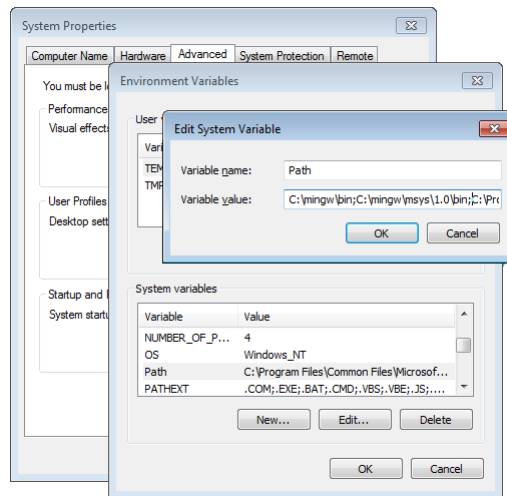

6 To verify the GNU tools installation and path settings, enter the following commands on the Windows command line:

- `gcc --version`
- `gdb --version`
- `as --version`
- `ar --version`
- `make --version`

Each command displays the tool name and version on the command line. If you receive a message that the command is not recognized, verify that you completed the preceding installation and path configuration instructions.

You can use versions of the GNU tools that are more recent than the tested versions at your own risk.

Configuring Your MathWorks Software to Work with Eclipse

After you install the third-party software, configure the coder product to work with Eclipse:

- 1 Close Eclipse IDE before you run `eclipseidesetup`. For more information, see “Build Errors” on page 39-16.
- 2 in the MATLAB Command Window, enter `eclipseidesetup`. The coder product opens the “IDE Link: Eclipse Adaptor Setup” dialog, as shown here on Windows:

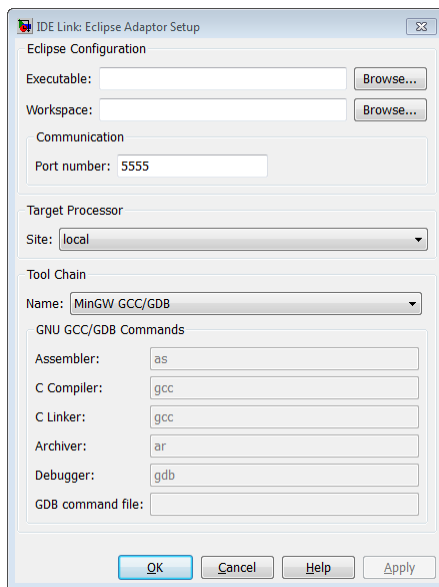

Note On Linux, the “IDE Link: Eclipse Adaptor Setup” dialog shows different options than on Windows

- 3 Update **Executable** with the location and file name of the Eclipse application file. For example, `C:\eclipse\eclipse.exe`.

You can get this value by right-clicking a shortcut for Eclipse and looking at the properties.

- 4** Update **Workspace** with the default location where Eclipse creates and saves new project files. For example, `C:\WINNT\Profiles\username\workspace`.

To find the current workspace, open Eclipse and select **File > Switch Workspace > Other**.

In the future, if you change the Eclipse workspace, repeat this configuration procedure.

Do not use workspace paths that contain spaces. If you have a path with spaces, recreate the workspace, and then update the path in Eclipse.

- 5** For **Port number**, enter a valid, unused, IP port number. For example, `5555`.
- 6** For **Site**, identify where the coder product uploads and runs the executable file upon completing the build process. Use either of these options:

- Choose `local` to run the executable on your Linux or Windows workstation.

This option requires the Simulink Coder product.

- Choose `remote` to download the executable to a remote target running Linux operating system over a network connection (for example, to connect to an embedded system connection to the Ethernet port on your workstation).

This option requires the Embedded Coder product.

You must perform additional steps to connect to a remote target running Linux. See “Additional Configuration Steps to Run Your Executable on a Remote Embedded Linux Target” on page 39-13.

Note Later on, when you configure the Target Hardware Resources tab in the model Configuration Parameters, and **Processor** to match the processor at the **Site** you selected.

For more information, see “Configure Target Hardware Resources” on page 35-3.

7 When you click **OK** or **Apply**, the coder product:

- Verifies the locations of the Executable and Workspace in the Eclipse Adaptor Setup dialog.
- Verifies that the required third-party software is present.
- Installs the coder product plug-ins in the Eclipse plugins folder. For example, in C:\Program Files\eclipse\plugins\.
- Saves configuration information to the `mwidelink.ini` file, located in the Eclipse plugins folder.

Note When Eclipse starts, it loads the coder product plug-in. The coder product plug-in loads the port number from `mwidelink.ini`. To resolve a port number conflict, change the port number by running `eclipseidesetup` again. Do not edit `mwidelink.ini`.

8 To verify that the configuration process is complete, create a handle object for the Eclipse IDE. Enter the following command in MATLAB

```
IDE_Obj = eclipseide
```

This command, starts Eclipse IDE if it is not already running, and creates a handle object. For example:

```
Starting Eclipse(TM) IDE...
```

```
ECLIPSEIDE Object:
```

```
Default timeout : 10.00 secs
```

```
Eclipse folder : C:\eclipse3.4\eclipse
```

```
Eclipse workspace: C:\WINNT\Profiles\rolfedh\workspace
```

```

Port number      : 5555
Processor site   : local

```

If you are using more recent versions of the GNU tools, you can disregard command-line warnings about using untested versions.

- 9 In Eclipse, click the following icon to see the status of the IDE Link plug-in.

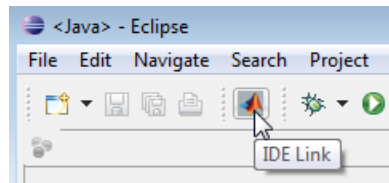

Additional Configuration Steps to Run Your Executable on a Remote Embedded Linux Target

On Linux host systems, you can configure the coder product to download and run an executable on a remote target running Embedded Linux.

During the “Configuring Your MathWorks Software to Work with Eclipse” on page 39-10 process, complete these additional steps:

- 1 Set **Site** to remote. The dialog displays additional **target hardware** and **GNU GCC/GDB Commands** parameters.
- 2 Under **target hardware**, enter the values the coder product uses to connect to the target hardware over the network:
 - **User login:** Supply a user name that has trusted “r-” access to the remote system. The user name must appear in the `/etc/hosts.equiv` or `$HOME/.rhosts` files on the remote system.
 - **IP address:** Enter the IP address of the remote system. To test the software on your local system instead of the remote system, enter `localhost`.
 - **Port number:** Enter the IP port number for communications between the two systems. For example, 10000.

- **Download path:** Enter the path on the remote system that receives the compiled executable and related files. For example, `./` sends the files to the home folder of the user login.

3 Under **GNU GCC/GDB Commands**, enter the tool chain commands and optional arguments the coder product uses to build executable for the target hardware.

For example, if you are using the generic GNU tool chain to build an executable for target hardware running Embedded Linux, enter:

- **Assembler:** `as`
- **C Compiler:** `gcc`
- **C Linker:** `gcc`
- **Archiver:** `ar`
- **Debugger:** `gdb`

For example, if you are using the MontaVista Linux tool chain to build an executable for an ARM processor running Embedded Linux, enter:

- **Assembler:** `arm_v5t_1e-as`
- **C Compiler:** `arm_v5t_1e-gcc`
- **C Linker:** `arm_v5t_1e-gcc`
- **Archiver:** `arm_v5t_1e-ar`
- **Debugger:** `arm_v5t_1e-gdb`

4 Click **OK** to complete the Eclipse Adaptor Setup process.

Also see “Working with Linux Target”.

Troubleshooting with Eclipse IDE

In this section...

“Profiling for ARM® Processors Running Embedded Linux Operating System” on page 39-15

“SIGSEGV Segmentation Fault for GDB” on page 39-16

“GDB Stops on Each Semaphore Post” on page 39-16

“Build Errors” on page 39-16

“Profiling Not Available for Intel x86/Pentium and AMD K5/K6/Athlon Processors Running Windows or Linux Operating Systems” on page 39-17

“Eclipse Message: “Can’t find a source file”” on page 39-17

“Eclipse Message: “Cannot access memory at address”” on page 39-18

“Some Versions of Eclipse CDT Do Not Catch GCC Errors” on page 39-18

Profiling for ARM® Processors Running Embedded Linux Operating System

Generating a free-running executable for ARM processors using MontaVista Tools RemoteHost, you may see the following warning:

```
Warning: "Real-time execution profiling is not supported for
ARM processors when no operating system is selected. The generated
code will have compiler errors. To profile on ARM processors,
select an operating system via the Target Hardware Resources
and rebuild the model. To enable profiling on ARM processors
when no operating system is selected, refer to the Embedded
Coder documentation."
```

GCC does not use an extra timer for execution profiling. Instead, Eclipse uses `time.h` from the ANSI C lib to define `clock_t`. When you use the `profile` function to profile target applications on ARM® processors running Embedded Linux, make `time.h` available for `#include`.

SIGSEGV Segmentation Fault for GDB

If you use Comodo Internet Security (CIS) software on your development system, CIS causes a SIGSEGV segmentation fault for GDB. When this fault occurs, you receive the following message:

```
Debugger name and version: GNU gdb (GDB) 7.0
Program received signal SIGSEGV, Segmentation fault.
In ntdll!RtlpWaitForCriticalSection () (C:\WINDOWS\system32\ntdll.dll)
Continuing...
Program received signal SIGSEGV, Segmentation fault.
In ?? () (C:\WINDOWS\system32\guard32.dll)
```

If you get this message, click **OK** and then click **Continue**.

For more information, see the “Guard32.dll causes SIGSEGV segmentation fault for GDB debugger CIS 3.9.95478 x32” topic at <http://forums.comodo.com/>.

GDB Stops on Each Semaphore Post

If you use gdb to debug a target application running on Linux, gdb stops on each semaphore post. You can override this expected behavior adding the following text to `.gdbinit`, the GDB init file:

```
handle SIG34 nostop noprint pass
handle SIG35 nostop noprint pass
```

On Linux, `.gdbinit` resides on your home folder, by default. For more information about creating `.gdbinit` and configuring gdb, consult the *GDB User Manual*, available from <http://www.gnu.org/software/gdb/documentation/>.

Build Errors

If you use `eclipseidesetup` without closing Eclipse IDE, you may get build errors similar to the following ones:

```
The call to idelink_ert_make_rtw_hook, during the exit hook generated the following error:
Error while creating the project.
```

```
The build process will terminate as a result.
```

```
===  
Error while creating the project.  
===  
Error creating a new project.  
===  
An exception occurred while performing this operation. 0
```

To solve this problem, close and restart Eclipse IDE.

Profiling Not Available for Intel x86/Pentium and AMD K5/K6/Athlon Processors Running Windows or Linux Operating Systems

Profiling is not available for Intel® x86/Pentium and AMD® K5/K6/Athlon processors running Windows or Linux.

Eclipse Message: “Can’t find a source file”

With specific Configuration Parameters, while building and loading a target application, Eclipse IDE displays a message that it could not find a source file. This message appears even if the load action completes. Here is an example of the message:

```
Can't find a source file at  
"../../sumdiff_bash_eclipseide/sumdiff_bash_main.c  
Locate the file or edit the source lookup path  
to include its location.
```

In Configuration Parameters, on the Coder Target pane, in the Vendor Tool Chain section: If **Configuration** is set to **Release** or **Custom**, the coder product does not specify the **-g** compiler option for gcc. Therefore, the build process does not produce debugging information gdb requires. Without this information, gdb cannot map the executable to the source file, resulting in the “Can’t find a source file” message.

To solve this problem, add **-g** to the **Compiler options string** for the **Custom** and **Release** configurations, or set **Configuration** to **Debug**.

Eclipse Message: “Cannot access memory at address”

If you use the coder product’s halt method to stop the target application, Eclipse displays a message similar to the following example:

```
[Switching to thread 5528.0x1664]
Quit (expect signal SIGINT when the program is resumed)
Cannot access memory at address 0x720000
Cannot access memory at address 0x720000
```

This error is not related to Eclipse IDE. It is a bug with gdb/MinGW. It typically occurs when gdb tries to access an invalid or protected memory location.

Some Versions of Eclipse CDT Do Not Catch GCC Errors

If you set a bad compiler flag, specific versions of Eclipse CDT prior to version 7.0.2 fail to catch gcc errors that the flag is wrong.

To reproduce this problem:

- 1** Open a project and select **C/C++ Build > Tool Chain Editor**.
- 2** Set **Current builder** to CDT Internal Builder.
- 3** Select **Project properties > C/C++ Build > Settings**.
- 4** Set **GCC C Compiler: Miscellaneous** to -D.
- 5** Build the project. Notice that gcc displays the following error while the Problems tab for the Eclipse IDE project does not display errors:

```
<command-line>: error: macro names must be identifiers
```

Working with Green Hills MULTI IDE

- “Install Support for Green Hills® MULTI® IDE” on page 40-2
- “Getting Started” on page 40-4
- “IDE Automation Interface” on page 40-12
- “IDE Project Generator” on page 40-35
- “Breakpoints and PIL” on page 40-44

Install Support for Green Hills MULTI IDE

You can add support for Green Hills MULTI IDE to the Embedded Coder product, using the following process.

After completing this process, you can use Embedded Coder software to automatically generate and build code with Green Hills MULTI IDE.

Using this installation process, you download and install the following items on your host computer:

- Related Embedded Coder software features
- Simulink block library called “Embedded Coder Support Package for Green Hills MULTI IDE”
- Related examples

For convenience, these instructions occasionally refer to Green Hills MULTI IDE as the “IDE”.

- 1** In a MATLAB Command Window, enter `targetinstaller`. This starts the Support Package Installer.
- 2** On the **Install or update support package** screen, select **Internet** and click **Next**.
- 3** Select the Green Hills MULTI check box, and click **Next**.

The **Installation folder** parameter specifies where Support Package Installer puts the target files. You must have write privileges for the installation folder.

- 4** For the remaining screens, follow the instructions provided by the Support Package Installer. To get additional information about any particular screen, click **Help**.
- 5** When Support Package Installer confirms that the installation is complete, click **Finish**. By default, Support Package Installer displays examples for MULTI IDE.
- 6** If you have not already installed Green Hills MULTI IDE, install it now.

- 7** In the MATLAB Command Window, enter `ghsmulticonfig`.
- 8** In the IDE Link Configuration for Green Hills MULTI dialog that opens, enter the parameter values, and click **OK**.

When you complete this process, you can use Embedded Coder software with Green Hills MULTI IDE.

Getting Started

In this section...
“Overview” on page 40-4
“Software Structure and Components” on page 40-5

Overview

Embedded Coder software provides an interface between MATLAB and the Green Hills MULTI software. The software enables you to

- Access the processor
- Manipulate data on the processor
- Manage projects within the IDE

while using the MATLAB numerical analysis and simulation functions.

Embedded Coder software connects MATLAB and Simulink with Green Hills MULTI integrated development and debugging environment from Green Hills. The software enables you to use MATLAB and Simulink to debug and verify embedded code running on many microprocessors that Green Hills MULTI software supports, such as the ARM, Freescale MPC7400, Blackfin, and Renesas V850 families.

Using the software, you can perform the following tasks and others related to Model-Based Design:

- Function calls — Write scripts in MATLAB to execute functions in the Green Hills MULTI IDE
- Automation — Write automated tests in MATLAB to execute on your processor, including control and verification operations
- Host-Processor Communication — Communicate with the processor directly from MATLAB, without going to the IDE
- Verification and Validation

- Load and execute projects into the Green Hills MULTI software from the MATLAB Command Window
- Build and compile code, and then use vectors of test data and parameters to test the code
- Build and compile your code, and then download the code to the processor and execute it
- Design models — Design models and algorithms in MATLAB and Simulink and run them on the processor
- Generate code — Generate executable code for your processor directly from the models designed in Simulink, and execute it

Embedded Coder software includes an IDE Project Generator component. With the IDE Project Generator component, you can generate a complete project file for Green Hills MULTI software from Simulink models, using C code generated with Embedded Coder software. Thus, you can use both Simulink Coder and Embedded Coder software to generate generic ANSI C code projects for Green Hills MULTI from Simulink models. You can then build and run the code on supported processors.

The following list suggests some of the uses for Embedded Coder software:

- Create test benches in MATLAB and Simulink for testing your manually written or automatically generated code running on a variety of DSPs
- Generate code and project files for Green Hills MULTI software from Simulink models using both Simulink Coder and Embedded Coder software for rapid prototyping or deployment of a system or application
- Build, debug, and verify embedded code on supported processors with MATLAB, Simulink, and Green Hills MULTI software
- Perform processor-in-the-loop (PIL) testing of embedded code

Software Structure and Components

- “Components” on page 40-6
- “IDE Automation Interface” on page 40-6
- “IDE Project Generator” on page 40-7

- “Verification” on page 40-7
- “Configuring Your Software” on page 40-7
- “Configuring Green Hills® MULTI® to use Full Folder Paths” on page 40-10

Components

Embedded Coder software comprises these components

- IDE Automation Interface — Enables communication between MATLAB and Green Hills MULTI software.
- IDE Project Generator — Uses Simulink to let you build models, simulate them, and generate code from the models directly to the processor.
- Verification — Validate and verify your projects. You can simulate algorithms and processes in Simulink models and concurrently on your processor. Comparing the concurrent simulation results helps verify the fidelity of your model or algorithm code.

IDE Automation Interface

The IDE Automation Interface component enables you to use MATLAB functions and methods to communicate with the Green Hills MULTI software. With the MATLAB functions, you can perform the following program development tasks:

- Automate project management.
- Debug projects by manipulating the data in the processor memory (internal and external) and registers.
- Exercise functions from your project on the processor.
- Communicate between the host and processor applications.

The IDE Automation Interface component provides the following functionality in the Debug component—methods and functions for project automation, debugging, and data manipulation.

IDE Project Generator

The IDE Project Generator component is a collection of methods that use the Green Hills MULTI API to create projects in Green Hills MULTI and generate code. With the interface, you can do the following:

- Automatic project-based build process — Automatically create and build projects for code generated by Embedded Coder.
- Custom code generation — Use System Target Files (STF) to generate both processor-specific and optimized code.
- Automatic downloading and debugging — Debug generated code in the Green Hills MULTI debugger, using either the instruction set simulator or real hardware.
- Create and build projects for Green Hills MULTI from Simulink models — IDE Project Generator uses Simulink Coder or Embedded Coder to build projects that work with supported processors.
- Generate custom code using the Configuration Parameters in your model with the system target files `idelink_ert.tlc` and `idelink_grt.tlc`.

Verification

Verifying your processes and algorithms is an essential part of developing applications. The components of Embedded Coder software provide the following verification tools.

- **Processor in the loop (PIL) simulation** — Use simulation techniques to verify generated code running in an instruction set simulator or real hardware environment.
- **Execution profiling** — Gather execution profiling measurements with Green Hills MULTI instruction set simulator to establish the timing requirements of your algorithm.

Configuring Your Software

Embedded Coder software requires some information about your MULTI installation before you can use the software to develop projects in MULTI from MATLAB. To configure the interface between MATLAB and MULTI, provide the information in the following table. Embedded Coder software

provides a GUI-based configuration utility to help you configure the software and interface.

GUI Parameter	Configuration Information	Description
Directory	MULTI installation folder	Identifies the path to your Green Hills software.
Configuration	Primary processor	Identifies the processor on which you are developing.
Debug server	Debug server type	Specifies the type of debug server to use.
Host name	Host name	Specifies the name of the system running Simulink software.
Port number	Port number	Specifies the port for host/target communications. The service listens on this port.

Configuring Embedded Coder Software. You must configure your installation before you start working with the software and MULTI.

To generate code for Blackfin processors, the software supports only the Green Hills version of the Blackfin compiler.

Note The software does not support using Analog Devices Blackfin compiler. When you select your configuration during the configuration process, do not select `bfadi_standalone.tgt` from the **Configuration** list. `bfadi_standalone.tgt` uses the ADI compiler.

Follow these steps to open the Embedded Coder configuration utility:

Note You must perform this configuration process before using Embedded Coder software.

- 1 Enter `ghsmulticonfig` at the MATLAB prompt.

The Embedded Coder Configuration dialog opens, as shown in the following figure.

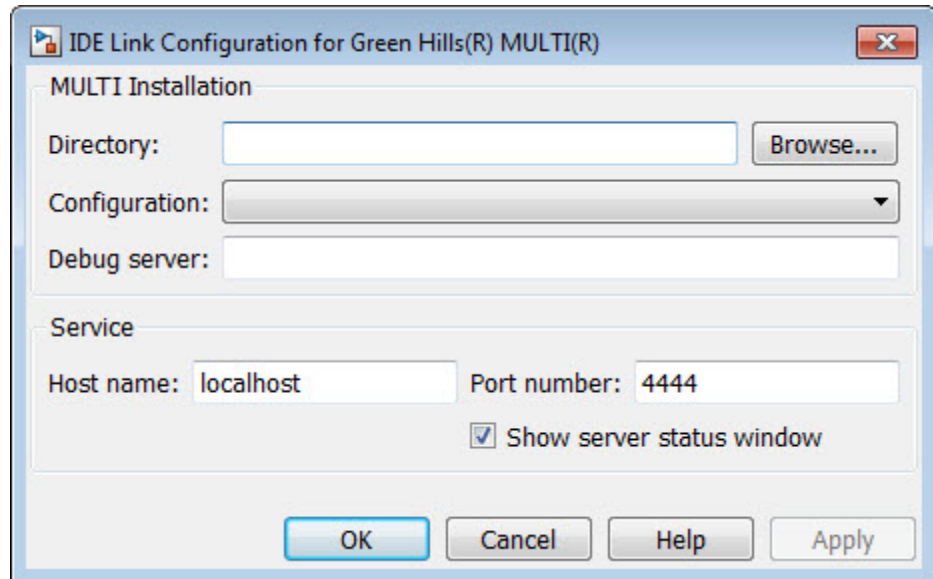

- 2 In the **Directory** field, enter the path to the executable file `multi.exe` for your Green Hills MULTI installation. To search for the file, click **Browse**.
- 3 From the **Configuration** list, select your primary processor. Embedded Coder software supports a variety of processors. Choose one that matches your development platform. In many cases, the `processor_standalone.tgt` variants, such as `ppc_standalone.tgt`, work well. Refer to your Green Hills MULTI documentation for more information about the configuration options for processors.
- 4 Enter the debug server string in **Debug server**. The string you enter sets specific values for processors, such as the board support library and whether the processor is big or little endian.

The standard input string is `debugconnection`. To use a processor simulator, such as the MPC7448 simulator, enter the string

```
simppc -cpu=ppc7448 -fast -dec-rom_use_entry
```

Your MULTI documentation provides more information about the debug server options and how to use them. You can find more debug server string for simulators in the reference material for ghsmulticonfig.

Note If you use a custom board, add the `-bsp` option to the **Debug server** string to specify your processor. For example, add `-bsp=mpc7448` if you use the MPC7448 EVB.

- 5** In **Host name**, enter the name of the machine that is going to run the IDE service. When you construct a `ghsmulti` object, the `ghsmulti` function starts the IDE service. To launch the service, the function needs to know where the service will run. The **Host name** string identifies that location. The default value is `localhost`, meaning the service runs on the local machine. Other inputs are not valid.
- 6** Enter the port number for the service in **Port number**.

Port number 4444 is the default port value. To change the port used, enter a different value in this field. Verify that the port you enter is available. If the port number you enter is not available, the IDE service does not start. Thus, you get an error message in MATLAB when you try to construct a `ghsmulti` object.
- 7** Select or clear **Show server status window** to specify whether the IDE service status appears in the task bar. The default value is to show the service status. Clearing **Show server status window** hides the status in the task bar. Select this option as a best practice. Keeping this option selected enables the software to shut down the communication services for Green Hills MULTI completely.
- 8** Click **OK** to complete the configuration process and close the dialog.

Configuring Green Hills MULTI to use Full Folder Paths

By default, the **Show Paths** option in MULTI uses relative file paths. Configure MULTI to use full folder paths instead:

- 1 Start MULTI from your desktop.
- 2 Switch to the Project Manager tool.
- 3 Select **View > Show Paths > Full Paths**.

Note With Green Hills MULTI, Embedded Coder outputs the derived files in the <builddir> folder. For example, in `model_ghsmulti`.

IDE Automation Interface

In this section...

“Getting Started with IDE Automation Interface” on page 40-12

“Constructing Objects” on page 40-28

“Properties and Property Values” on page 40-29

“ghsmulti Object Properties” on page 40-32

Getting Started with IDE Automation Interface

- “Introducing the IDE Automation Interface” on page 40-12
- “Starting and Stopping Green Hills® MULTI® From the MATLAB Desktop” on page 40-14
- “Interactive Learning” on page 40-18
- “Querying Objects for Green Hills® MULTI® Software” on page 40-18
- “Loading Files into Green Hills® MULTI® Software” on page 40-19
- “Running the Project” on page 40-21
- “Working With Data in Memory” on page 40-21
- “More Memory Data Manipulation” on page 40-24
- “Closing the Connections to Green Hills® MULTI® Software” on page 40-26
- “Review” on page 40-27

Introducing the IDE Automation Interface

Embedded Coder software provides a connection between MATLAB software and a processor in Green Hills MULTI development environment. You use MATLAB objects as a mechanism to control and manipulate a signal processing application using the computational power of MATLAB software. This approach can help you while you debug and develop your application. Another possible use for automation is creating MATLAB scripts that verify and test algorithms that run in their final implementation on your production processor.

Note Before using the functions available with the objects, you must designate a server and processor in Green Hills MULTI software. The object you create is specific to the server and processor you specify.

To help you start using objects in the software, Embedded Coder software includes a tutorial—`multilinkautointttutorial.m`. As you work through this tutorial, you perform the following tasks that step you through creating and using objects to interact with the Green Hills MULTI IDE:

- 1 Select your primary server and port.
- 2 Create and query objects to Green Hills MULTI IDE.
- 3 Use MATLAB to load files into Green Hills MULTI IDE.
- 4 Work with your Green Hills MULTI IDE project from MATLAB.
- 5 Close the connections you opened to Green Hills MULTI IDE.

The tutorial covers some methods and functions for the software. The following tables show functions and methods for the software. The functions do not require an object. The methods require an existing `ghsmulti` object to use as an input argument for the method.

Functions for Working with Green Hills MULTI. The following table shows functions that do not require an object.

Function	Description
<code>ghsmulti</code>	Construct an object that refers to a Green Hills MULTI IDE instance. When you construct the object you specify the IDE instance by host and port.
<code>ghsmulticonfig</code>	Set Embedded Coder software preferences.

Methods for Working with `ghsmulti` Objects in Green Hills MULTI. The following table presents some of the methods that require a `ghsmulti` object.

Methods	Description
add	Add file to project
address	Return address and page for entry in symbol table in Green Hills MULTI IDE
build	Build project in Green Hills MULTI
cd	Change working folder
connect	Connect IDE to processor
display (IDE Object)"	Display properties of object that references Green Hills MULTI IDE
halt	Terminate execution of process running on processor
isrunning	Test whether processor is executing process
load	Load built project to processor
open	Open file in project
read	Retrieve data from memory on processor
regread	Read values from processor registers
regwrite	Write data values to registers on processor
reset	Restore program counter (PC) to entry point for current program.
restart	Restore processor to program entry point
run	Execute program loaded on processor
write	Write data to memory on processor

Starting and Stopping Green Hills MULTI From the MATLAB Desktop

Embedded Coder software provides you the ability to control MULTI software from the MATLAB command window. When you create a `ghsmulti` object, MATLAB starts the services shown in the following table to enable MATLAB to communicate with the Green Hills MULTI IDE:

Service Type for Each Port	Process Name	Description
Python Service	mpythonrun.exe	Python is a programming language the software uses to establish a connection between MATLAB and MULTI.
Python Service	svc_python.exe	Connection to IDE.
Python Service	svc_router.exe	Connection to IDE.
Python Service	svc_statemgr.exe	Connection to IDE
Python Service	svc_window.exe	Connection to IDE.
IDE service	Not applicable	Enables MATLAB to send commands to the Green Hills MULTI development environment. This is a child process of the python services.

Each time you create a `ghsmulti` object, the software starts another set of the python services shown in the table.

Starting Green Hills MULTI From MATLAB. When you use the `ghsmulti` function, the software starts two classes of services—python services and the IDE service for each new port. The entries in the following table describe how the software controls the IDE when you create a `ghsmulti` object:

Create <code>ghsmulti</code> Object with <code>ghsmulti</code> Function	Status of IDE	Result
<code>id=ghsmulti</code>	Not running	The software starts the IDE service and the IDE connects to the default host name and port

Create ghsmulti Object with ghsmulti Function	Status of IDE	Result
		number—localhost and 4444 as set in the configuration options.
<code>id=ghsmulti('hostname','localhost','portnum',4444)</code>	Not running	The software starts the IDE service and the IDE and connects to the specified host name and port number—localhost and 4444.
<code>id2=ghsmulti</code>	Running	The software connects to the existing IDE service connected to the default host name and port.
<code>id2=ghsmulti('hostname','localhost','portnum',4446)</code>	Running	The software starts a new the IDE service connected to the specified host name and port number.

When the software starts the IDE service, it displays a dialog that includes the following details:

Hostname — the name of the host. For example, localhost

Port Num — the port number. For example, 4444

#Clients — the number of clients. For example, 1

MultiDir — the location of the multi installation. For example, C:\ghs5_01

To open the MULTI Launcher utility, click the **Launcher** button in the service dialog.

Stopping Green Hills MULTI From MATLAB. After you complete your development work with the software, best practice suggests that you close the IDE from MATLAB. Two conditions control how you close the IDE, as shown in the following table:

The IDE service State	To Close the IDE
<p>One or more services appear in the task bar and the IDE service dialogues are visible.</p>	<p>Perform these steps:</p> <ol style="list-style-type: none"> 1 Enter <code>clear all</code> in MATLAB to remove the <code>ghsmulti</code> objects from your workspace. 2 Verify that the MULTI clients are disconnected by checking that #Clients in each service dialog is 0. 3 Close the service dialogues.
<p>Services appear in the task bar but the service dialogues are not visible.</p>	<p>Perform these steps:</p> <ol style="list-style-type: none"> 1 Enter <code>clear all</code> in MATLAB to remove the <code>ghsmulti</code> objects from your workspace. 2 Open the Microsoft Windows Task Manager. 3 Click Processes. 4 Select <code>svc_router.exe</code> from the list. Closing this service stops <code>mpythonrun.exe</code>, <code>svc_window.exe</code>, and <code>svc_statemgr.exe</code>. 5 Click End Now. 6 Select <code>svc_python.exe</code> from the list. 7 Click End Now.

Note Clicking the task bar icon for the service and selecting close does not close the IDE.

Interactive Learning

You have the option of running this tutorial from the MATLAB Command Window or entering the functions as described in the following tutorial sections.

To run the tutorial in MATLAB, click run `multilinkautointtutorial`. This command launches the tutorial in an interactive mode where the tutorial program provides prompts and text descriptions to which you respond to move to the next section. The interactive tutorial covers the same information provided by the following tutorial sections. You can view the tutorial MATLAB file used here by clicking `multilinkautointtutorial.m`.

Querying Objects for Green Hills MULTI Software

In this tutorial section you create the connection between MATLAB and Green Hills MULTI IDE. This connection, or `ghsmulti` object, is a MATLAB object that you save as variable `id`. You use function `ghsmulti` to create `ghsmulti` objects. `ghsmulti` supports input arguments that let you specify values for `ghsmulti` object properties, such as the global timeout. Refer to the `ghsmulti` reference information for more about the input arguments.

Use the generated object `id` to direct actions to your project and processor. In the following tasks, `id` appears in method syntax that interacts with the IDE primary target and the processor: The object `id` identifies and refers to a specific instance of the IDE.

You must include the object in the method syntax you use to access and manipulate a project or files in a session in Green Hills MULTI software:

- 1** Create an object that refers to your selected service and port. Enter the following command at the prompt.

```
id = ghsmulti('hostname','localhost','portnum',4444)
```

- 2** Next, enter `display(id)` at the prompt to see the status information.

```
MULTI Object:
  Host Name      : localhost
  Port Num      : 4444
  Default timeout : 10.00 secs
  MULTI Dir     : C:\ghs\multi500\ppc\
```

Embedded Coder software provides methods to read the status of a processor:

- `info` — Return a structure of testable session conditions.
- `display` — Print information about the session and processor.
- `isrunning` — Return the state (running or halted) of the processor.

3 Verify that the processor is running by entering

```
runstatus = isrunning(id)
```

The MATLAB prompt responds with message that indicates the processor is stopped:

```
runstatus =
    0
```

Loading Files into Green Hills MULTI Software

You have established the connection to a processor and board and have created and queried objects. Next, give the processor something to do.

In this part of the tutorial, you load the executable code for the CPU in the IDE. Embedded Coder software includes a tutorial project file for Green Hills MULTI. Through the next commands in the tutorial, you locate the tutorial project file and load it into Green Hills MULTI. The `open` method directs Green Hills MULTI to load a project file or workspace file.

Note To continue the tutorial, you must identify or create a folder to which you have write access. Embedded Coder software cannot create a folder for you. Create one in the Microsoft Windows folder structure before you proceed with the this tutorial.

Green Hills MULTI has its own workspace and workspace files that are quite different from MATLAB workspace files and the MATLAB workspace. Remember to monitor both workspaces. To change the working folder to your writable folder:

- 1** Use `cd` to switch to the writable folder

```
prj_dir=cd('C:\ide_link_mu_demo')
```

where the name and path to the writable folder is a string, such as `C:\ide_link_mu_demo` as used in the example. Replace `C:\ide_link_mu_demo` with the full path to your writable folder.

- 2** Change your working folder to the new folder by entering the following command:

```
cd(id,prj_dir)
```

- 3** Use the following command to create a new Green Hills MULTI project named `debug_demo.gpj` in the new folder:

```
new(id,'debug_demo.gpj')
```

Switch to the IDE to verify that your new project exists. Next, add source files to your project.

- 4** Add the provided source file—`multilinkautointtutorial.c` to the project `debug_demo.gpj` using the following command:

```
add(id,'multilinkautointtutorial.c')
```

- 5** Save your project.

```
save(id,'my_debug_demo.gpj','project')
```

Your IDE project is saved with the name `my_debug_demo.gpj` in your writable folder. The input string, `project`, specifies that you are saving a project file.

- 6** Next, set the build options for your project. Use the following command to set the compiler build options to use and specify a processor (optional).

```
setbuilddopt(id,'Compiler',' -G -cpu=V850')
```

The input argument `-cpu=V850` is optional to specify the processor.

Running the Project

After you create `dot_project_c.gpj` in the IDE, you can use Embedded Coder software functions to create executable code from the project and load the code to the processor.

To build the executable and download and run it on your processor:

- 1 Use the following build command to build an executable module from the project `debug_demo.gpj`.

```
build(id,'all',20) % Set optional time-out period to 20 seconds.
```

- 2 To load the new executable to the processor, use `load` with the project file name and the object name. The name of the executable is `debug_demo`.

```
load(id,'debug_demo',30); % Set time-out value to 30 seconds.
```

Embedded Coder software provides methods to control processor execution—`run`, `halt`, and `reset`. To see these methods, use `run` to start the program you just loaded on to the processor, and then use `halt` to stop the processor.

- 1 Enter the following methods at the command prompt and review the response in the MATLAB command window.

```
run(id)      % Start the program running on the processor.
halt(id)     % Halt the processor.
reset(id)    % Reset the program counter to start of program.
```

Use `isrunning` after the `run` method to verify that the processor is running. After you stop the processor, `isrunning` can verify that the processor has stopped.

Working With Data in Memory

Embedded Coder software provides methods that enable you to read and write data to memory on the processor. Reading and writing data depends

on the symbol table for your project. The symbol table is available only after you load the executable into the debugger. This section introduces `address` and `dec2hex`. Use them to read the addresses of two global variables—`ddat` and `idat`.

- 1 After you load `debug_demo` into the debugger, enter the following commands to read the addresses of `ddat` and `idat`:

```
ddatA=address(id,'ddat')
ddatA =
      3145744      0
```

```
ddatI=address(id,'idat')
```

```
ddatI =
      3145728      0
```

- 2 Review the results in hexadecimal representation.

```
dec2hex(ddatA)
```

```
ans =
```

```
300010
000000
```

```
dec2hex(ddatI)
```

```
ans =
```

```
300000
000000
```

After you load the target code to the processor, you can examine and modify data values in memory, as the previous `read` function examples showed.

For non-changing data values in memory (static values), the values are available immediately after you load the program file.

A more interesting case is looking at variable values that change during program execution. Manipulating changing data values at intermediate points during execution can provide helpful analysis and verification information.

To enable you to read and write data while your program is running, the software provides methods to insert and delete breakpoints in the source programs. Inserting breakpoints lets you pause program execution to read or change variable data values. You cannot change values while your program is running.

The method `insert` creates a new breakpoint at either a source file locations, such as a line number, or at a physical memory address. `insert` takes either the line number or the address as an input argument.

To read the values in the next section of this tutorial, use the following methods to insert breakpoints at lines 24 and 29 in the source file `multilinkautointttutorial.c`

- 1** Change folders to your original working folder.

```
cd(id,proj_dir);
```

- 2** (Optional for convenience) Create variables for the line numbers in the source file.

```
brkpt24 = 24;  
brtpt29 = 29;
```

- 3** Use the following commands to insert breakpoints on line 24 and line 29 of the source file:

```
insert(id,'multilinkautointttutorial',brkpt24); % Insert breakpoint on line 24.  
insert(id,'multilinkautointttutorial',brkpt29); % Insert breakpoint on line 29.
```

- 4** Open and activate the file in the IDE from the MATLAB command window by issuing the following commands:

```
open(id,'multilinkautointttutorial');  
activate(id,'multilinkautointttutorial');
```

Activating `multilinkautoinntutorial.c` transfers focus in the IDE to the activated file. Switch to the IDE to verify that the file is in your project and open.

When you look in the IDE debugger window, the breakpoints you added to `multilinkautoinntutorial.c` are marked by a STOP sign icon on lines 24 and 29.

A similar method, `remove`, deletes breakpoints.

To help you inspect the source file in the IDE and verify the breakpoints, the `open` and `activate` methods display the file `multilinkautoinntutorial.c` in the IDE and force the source file to the front.

One final method actually connects the IDE to your hardware or simulator. `connect` takes a `ghsmulti` object as an input argument to connect the specific IDE primary target referenced by `id` to the associated processor.

More Memory Data Manipulation

The source file `multilinkaautoinntutorial.c` defines two 1-by-4 global data arrays—`ddat` and `idat`. You can locate the declaration in the file. Embedded Coder software provides the read and write methods so you can access the arrays from MATLAB. Find the declaration and note the initialization values.

This tutorial section shows reading and writing data in memory, and controlling the processor.

- 1** Get the address of the symbols `ddat` and `idat`. Enter the following commands at the prompt.

```
ddat_addr=address(id,'ddat'); % Get address from symbol table.  
idat_addr=address(id,'idat');
```

- 2** Create two MATLAB variables to specify the data types for `ddat` and `idat`.

```
ddat_type='double';  
idat_type='int32';
```

- 3** Declare some values in two MATLAB variables.

```
ddat_value=double([pi 12.3 exp(-1) sin(pi/4)]);
idat_value=int32(1:4);
```

- 4** Stop the processor.

```
halt(id)
```

- 5** Reload the project. If you did not save the source file in the project, reloading the project removes the breakpoints you added and move the program counter (PC) to the start of the program.

```
% Reload program file (.gpj). Reset PC to program start.
reload(id,100);
```

- 6** Use the following commands to restore the breakpoints on line 24 and 29.

```
insert(id,'multilinkautointttutorial.c',brkpt24);
insert(id,'multilinkautointttutorial.c',brkpt29);
```

- 7** Use the following method to connect the IDE to the processor:

```
connect(id);
```

- 8** With the breakpoints in the code, run the program until it stops at the first breakpoint on line 24.

```
run(id,'runtohalt',30); % Set time-out to 30 seconds.
```

- 9** Check the current values stored in ddat and idat. Later in this tutorial you change these values from MATLAB.

```
% Do ddat values match initialization values in the source?
ddatV=read(id,address(id,'ddat',ddat_type,4))
idatV=read(id,address(id,'idat',idat_type,4))
```

MATLAB displays the values of ddatV and idatV.

```
ddatV=
```

```
    16.300    -2.1300    5.1000   11.8000
```

```
idatV=
```

```
1 508 646 7000
```

- 10** Change the values in `ddat` and `idat` by writing new values to the memory addresses.

```
% Write pi, 12.3, exp(-1), and .7070 to memory.
write(id,address(id,'ddata'),ddat_value)
% Write vector [1:4] to memory.
write(id,address(id,'idat'),idat_value)
```

- 11** Resume the program execution from the breakpoint and run until the program stops.

```
run(id,'runtohalt','30'); % Stop at next breakpoint (line 29).
```

- 12** Read the values in memory for `ddat` and `idat` to verify the changes.

```
% Read the data as double data type.
ddatV = read(id,address(id,'ddat'),ddat_type,4)

ddatV=

3.1416  12.3000  0.3679  0.7071

% Read the data as int32 data type.
idatV = read(id,address(id,'idat'),idat_type,4)

idatV=

1 2 3 4
```

The data stored in `ddat` and `idat` are what you wrote to memory.

- 13** After you review the data, restart the processor to run to return the PC to the program start.

```
restart(id);
```

Closing the Connections to Green Hills MULTI Software

Objects that you create in Embedded Coder software have connections to Green Hills MULTI IDE. Until you delete these objects, the Green Hills

MULTI process (`Idde.exe` in the Windows Task Manager) remains in memory. Closing MATLAB removes these objects automatically, but there may be times when it helps to delete the handles manually, without quitting MATLAB.

Note When you clear the last `ghsmulti` object, the software does not close the running IDE service. When it does close the IDE, it does not save current projects or files in the IDE, and it does not prompt you to save them.

A best practice is to save your projects and files before you clear `ghsmulti` objects from your MATLAB workspace.

Use the following commands to close the project files in Green Hills MULTI IDE and remove the breakpoints you added to the source file.

```
close(id,'debug_demo.gpj','project') % Close the project file.
remove(id,'multilinkautointttutorial.c',brkpt24);

remove(id,'multilinkautointttutorial.c',brkpt29);
```

Finally, to delete your link to Green Hills MULTI use `clear id`.

You have completed the IDE Automation Interface tutorial using Embedded Coder software.

Review

During the tutorial you performed the following tasks:

- 1 Created and queried objects that refer to a session in Embedded Coder software to get information about the session and processor.
- 2 Used MATLAB software to load files into the Green Hills MULTI IDE and used methods in MATLAB software to run that file.
- 3 Closed the links you opened to Green Hills MULTI software.

This set of tasks is used in development of signal processing applications. Thus, the tutorial gives you a working process for using Embedded Coder

software and your signal processing programs to develop programs for a range of processors.

Constructing Objects

When you create a connection to a session in Green Hills MULTI using the `ghsmulti` function, you create a `ghsmulti` object (in object-oriented design terms, you *instantiate* the `ghsmulti` object). The object implementation relies on MATLAB object-oriented programming capabilities like the objects in MATLAB or DSP System Toolbox software.

The discussions in this section apply to the objects in Embedded Coder software. Because `ghsmulti` objects use the MATLAB software techniques, the information about working with the objects, such as how you get or set object properties or use methods, apply to the `ghsmulti` objects in Embedded Coder software.

Like other MATLAB structures, `ghsmulti` objects have predefined fields referred to as *object properties*.

You specify object property values by the following methods:

- Specifying the property values when you create the object
- Creating an object with default property values, and changing these property values later

For examples of setting link properties, refer to “Setting Property Values with `set`”.

Constructor for `ghsmulti` Objects

The easiest way to create an object is to use the function `ghsmulti` to create an object with the default properties. Create an object named `id` referring to a session in Green Hills MULTI by entering the following syntax:

```
id = ghsmulti
```

MATLAB responds with a list of the properties of the object `id` you created along with the associated default property values.

```
MULTI Object:
  Host Name      : localhost
  Port Num       : 4444
  Default timeout : 10.00 secs
  MULTI Dir      : C:\ghs\multi500\ppc\
```

The object properties are described in the `ghsmulti` documentation.

Note These properties are set to default values when you construct links.

Properties and Property Values

- “Working with Properties” on page 40-29
- “Setting and Retrieving Property Values” on page 40-29
- “Setting Property Values Directly at Construction” on page 40-30
- “Setting Property Values with `set`” on page 40-31
- “Retrieving Properties with `get`” on page 40-31
- “Direct Property Referencing to Set and Get Values” on page 40-31
- “Overloaded Functions for `ghsmulti` Objects” on page 40-32

Working with Properties

Links (or objects) in this Embedded Coder software have properties associated with them. Each property is assigned a value. You can set the values of most properties, either when you create the link or by changing the property value later. However, some properties have read-only values. Also, a few property values, such as the board number and the processor to which the link attaches, become read-only after you create the object. You cannot change those after you create your link.

Setting and Retrieving Property Values

You can set `ghsmulti` object property values by either of the following methods:

- Directly when you create the link — see “Setting Property Values Directly at Construction”
- By using the `set` function with an existing link — see “Setting Property Values with `set`”

Retrieve `ghsmulti` object property values with the `get` function.

Direct property referencing lets you either set or retrieve property values for `ghsmulti` objects.

Setting Property Values Directly at Construction

To set property values directly when you construct an object, include the following entries in the input argument list for the constructor method `ghsmulti`:

- A string for the property name to set, followed by a comma. Enclose strings in single quotation marks.
- The property value to associate with the named property. Sometimes this value is also a string.

You can include as many property names in the argument list for the object construction command as there are properties to set directly.

Setting Link Property Values at Construction. Create a connection to an instance of the IDE in Green Hills MULTI software and set the following object properties:

- Link to the specified MULTI instance and host.
- Specify the communication port on the host.
- Set the global timeout to 5 s. The default is 10 s.

Set these properties when you construct the object by entering

```
id = ghsmulti('hostname','localhost','portnum',4444,'timeout',5);
```

The `localhost`, `portnum`, and `timeout` properties are described in [Link Properties](#), as are the other properties for links.

Setting Property Values with set

After you construct an object, the `set` function lets you modify its property values.

Using the `set` function, you can Set link property values.

Setting Link Property Values Using set. To set the timeout specification for the link `id` from the previous section, enter the following syntax:

```
set(id,'timeout',8);
```

```
get(id,'timeout');  
ans=
```

```
8
```

The display reflects the changes in the property values.

Retrieving Properties with get

You can use the `get` command to retrieve the value of an object property.

Retrieving Link Property Values Using get. To retrieve the value of the `hostname` property for `id`, and assign it to a variable, enter the following syntax:

```
host=get(id,'hostname')
```

```
host =
```

```
localhost
```

Direct Property Referencing to Set and Get Values

You can directly set or get property values using MATLAB structure-like referencing. Do this by using a period to access an object property by name, as shown in the following example.

Direct Property Referencing in Links. To reference an object property value directly, perform the following steps:

- 1 Create a link with default values.
- 2 Change its time out and number of open channels.

```
id = ghsmulti;  
id.time = 6;
```

Overloaded Functions for ghsmulti Objects

Several methods and functions in Embedded Coder software have the same name as functions in other MathWorks products. These functions behave similarly to their original counterparts, but you apply them to an object. This concept of having functions with the same name operate on different types of objects (or on data) is called *overloading* of functions.

For example, the `set` command is overloaded for objects. After you specify your object by assigning values to its properties, you can apply the methods in this toolbox (such as `address` for reading an address in memory) directly to the variable name you assign to your object. You do not have to specify your object parameters again.

For a list of the methods that act on `ghsmulti` objects, refer to the “Working with Green Hills MULTI IDE” in the function reference pages.

ghsmulti Object Properties

- “Quick Reference to ghsmulti Properties” on page 40-32
- “Details About ghsmulti Object Properties” on page 40-33

Quick Reference to ghsmulti Properties

The following table lists the properties for the links in Embedded Coder software. The second column indicates to which object the property belongs. Knowing which property belongs to each object in an interface tells you how to access the property.

Property Name	User Settable?	Description
hostname	At construction only	Reports the name of the host the IDE service in Green Hills MULTI that the object references.
portnum	At construction only	Stores the number of the port to communicate with MULTI.
timeout	Yes/default	Contains the global timeout setting for the link.

Some properties are read only. Thus, you cannot set the property value. Other properties, you can change. If the entry in the User Settable column is “At construction only,” you can set the property value only when you create the object. Thereafter, it is read only.

Details About ghsmulti Object Properties

To use the objects for Green Hills MULTI interface, set values for the following:

- `hostname` — Specify the session with which the object interacts.
- `portnum` — Specify the processor in the session. If the board has multiple processors, `procnum` identifies the processor to use.
- `timeout` — Specify the global timeout value. (Optional. Default is 10 s.)

Details of the properties associated with `ghsmulti` objects appear in the following sections, listed in alphabetical order by property name.

hostname. Property `hostname` identifies the host that is running the IDE service. Use `hostname` to specify the machine to host your service.

To work with a service, you need the `hostname` and `portnum` values. `hostname` supports the string `localhost` only.

portnum. Property `portnum` specifies the port for communicating with the IDE service. MATLAB uses sockets to communicate with Green Hills MULTI. The `portnum` property value specifies the port, with a default value of 4444. When you create a new `ghsmulti` object, Embedded Coder software assumes the port value is 4444 unless you enter a different value when you configure the software or use the `portnum` input argument with `ghsmulti`.

timeout. Property `timeout` specifies how long Green Hills MULTI waits for processes to finish. You set the global timeout when you create an object for a session in Green Hills MULTI. The default global timeout value 10 s. The following example shows the `timeout` value for object `id2`.

```
display(id2)
```

```
MULTI Object:
```

```
Host Name      : localhost
Port Num       : 4444
Default timeout : 10.00 secs
MULTI Dir      : C:\ghs\multi500\ppc\
```

IDE Project Generator

In this section...

“Introducing IDE Project Generator” on page 40-35

“Generate an IDE Project” on page 40-36

“Model Reference” on page 40-40

Introducing IDE Project Generator

IDE Project Generator provides the following features for developing projects and generating code:

- Automated project building for Green Hills MULTI that lets you create MULTI projects from code generated by Embedded Coder. IDE Project Generator populates projects in the MULTI development environment.
- Blocks in the library `idelinklib_ghsmulti` for controlling the scheduling and timing in generated code.
- Highly configurable code generation using model Configuration Parameters.
- Ability to use one of two system target files to generate code specific to your processor.
- Highly configurable project build process.
- Automatic downloading and running of your generated projects on your processor.

To configure your Simulink models to use the IDE Project Generator component, do one or both of the following tasks:

- Configure your model for your IDE, tool chain, and target hardware, as described in “Configure Target Hardware Resources” on page 35-3. On the Tool Chain Automation tab, set the Build format parameter to Project. If Project is not available, the IDE/Tool Chain parameter on the Target Hardware Resources tab is set to an option that does not support automatic creation of IDE projects. In that case, use the makefile approach

to building software, of, if available select an IDE/Tool Chain that supports IDE project generation.

- To use the asynchronous scheduler capability in Embedded Coder software, add a hardware interrupt block or idle task block.

The following sections describe the blockset and the blocks in it, the scheduler, and the IDE Project Generator component.

Generate an IDE Project

- “Process for Building and Generating a Project” on page 40-36
- “Create the Model” on page 40-37
- “Specifying Simulink Configuration Parameters for Your Model” on page 40-37
- “Creating Your Project” on page 40-39

Process for Building and Generating a Project

In this tutorial, you build a model and generate a project from the model into Green Hills MULTI.

Note The model shows project generation only. You cannot build and run the model on your processor without additional blocks.

This is an overview of the process for generating a project from a model:

- 1** Use Simulink blocks, DSP System Toolbox blocks, and blocks from other blocksets to create the model application.
- 2** Configure your model for your IDE, tool chain, and target hardware, as described in “Configure Target Hardware Resources” on page 35-3.
- 3** Set the Configuration Parameters for your model, including the following parameters:

- Solver parameters such as simulation start and solver options. Choose the discrete solver when you generate executables. If you are using PIL, select any setting from the **Type** and **Solver** lists.
- Code Generation settings such as processor configuration and processor compiler selection

4 Generate your project.

5 Review your project in MULTI.

Create the Model

To build a model, follow these steps:

- 1** Open the Simulink Library Browser.
- 2** Use Simulink blocks to create a model.
- 3** Name and save your model before continuing.

Specifying Simulink Configuration Parameters for Your Model

The following sections describe how to configure the build and run parameters for your model. Generating a project, or building and running a model on the processor, starts with configuring model options in the Configuration Parameters dialog in Simulink.

Setting Solver Options. After you have designed and implemented your digital signal processing model in Simulink, complete the following steps to set the Configuration Parameters for the model:

- 1** Open the Configuration Parameters dialog and set the options on the **Solver** category for your model and for Embedded Coder software.
 - Set **Start time** to 0.0 and **Stop time** to inf (model runs without stopping). If you set a stop time, your generated code does not honor the setting. Set this parameter to inf for completeness.
 - Under **Solver options**, set **Type** to fixed-step and set **Solver** to discrete (no continuous states). For PIL, set **Type** and **Solver** to any setting.

- For **Fixed step size (fundamental sample time)**, enter Auto, and set **Tasking mode for periodic sample times** to SingleTasking.

Note Generated code does not honor Simulink stop time from the simulation. Stop time is interpreted as `inf`. To implement a stop in generated code, you must put a Stop Simulation block in your model.

Ignore the **Data Import/Export**, **Diagnostics**, and **Optimization** panes in the Configuration Parameters dialog. The default settings are valid for your new model.

Setting Code Generation Options. To configure Simulink Coder software to use the processor files, compile your model, and run your model executable file, set the options in the **Code Generation** category of the model Configuration Parameters. Follow these steps to set the Simulink Coder software options to generate code tailored for your processor:

- 1 In the Configuration Parameters dialog, select the **Code Generation** pane.
- 2 Click the **Browse** button next to **System target file** and set the system target file to `idelink_grt.tlc` or `idelink_ert.tlc` (if you use Embedded Coder software).

Clicking **Browse** opens the **System Target File Browser** to allow you to change the system target file.

- 3 On the **System Target File Browser**, select the `idelink_grt.tlc` or `idelink_ert.tlc` system target file, and click **OK** to close the browser.

Setting Coder Target Options. After you set the Configuration Parameters for code generation, set the options that apply to your Embedded Coder software run-time and build processes.

- 1 Configure your model for your IDE, tool chain, and target hardware, as described in “Configure Target Hardware Resources” on page 35-3.
- 2
- 3 On the Tool Chain Automation tab, set:

- **Build action:** Create_project.
 - **Interrupt overrun notification method:** Print_message.
- 4** (optional) Under **Link Automation**, verify that **Export MULTI link handle to base workspace** is selected and provide a name for the handle in **MULTI link handle name**.
 - 5** If you are using an actual board, identify a Board Support Package (BSP) in the **Compiler options string** (under **Vendor Tool Chain**). For example, enter “-bsp=at91rm9200”. If you do not provide this type of information, the software can generate errors that do not identify the absence of linker directives as the cause.
 - 6** Clear the options on the Code Generation pane.
 - 7** Select the **Hardware Implementation** pane.
 - 8** Verify that the **Device type** is valid for your processor—Analog Devices, Renesas, or Freescale.

You have configured the Code Generation pane settings to generate a project for your processor. A few of the panes under the node for the Code Generation pane, such as Comments and Symbols do not require configuration.

For your new model, the default values for the options in these panes are valid. For other models you develop, setting the options in these panes provides more information during the build process. Some of the options configure the model to run TLC debugging when you generate code. Refer to your Simulink and Simulink Coder documentation for more information about setting the Configuration Parameters.

Creating Your Project

After you set the Configuration Parameters and configure Simulink Coder to create the files you need, you direct Simulink Coder to create your project:

- 1** Click **OK** to close the Configuration Parameters dialog.
- 2** To verify that you configured your Embedded Coder software, issue the following command at the prompt to open the IDE Link Configuration for Green Hills MULTI dialog.

```
ghsmulticonfig
```

- 3** Verify the settings in the Embedded Coder dialog.
- 4** After you verify the settings, click **OK** to close the dialog.
- 5** Enter `cd` at the prompt to verify that your working folder is the right one to store your project results.
- 6** Click **Build Model**  on the model toolstrip. This action generates a Green Hills MULTI IDE project from your model.

When you press  with `Create_project` selected for **Build action**, the build process starts the Green Hills MULTI application and populates a new project.

Model Reference

- “About Model Reference” on page 40-40
- “How Model Reference Works” on page 40-41
- “Using Model Reference” on page 40-42
- “Configuring Targets to Use Model Reference” on page 40-43

About Model Reference

Model reference lets your model include other models as modular components. This technique is useful because it provides the following capabilities:

- Simplifies working with large models by letting you build large models from smaller ones, or even large ones.
- Lets you generate code for the modules in the model, and later, regenerate code for modules that change.
- Lets you develop the modules independently.
- Lets you reuse modules and models by reference, rather than including the model or module multiple times in your model. Also, multiple models can refer to the same model or module.

Your Simulink Coder documentation provides much more information about model reference.

How Model Reference Works

Model reference behaves differently in simulation and in code generation. This discussion uses the following terms:

- The *top-model* is the root model block or model. It refers to other blocks or models. In the model hierarchy, this model is the topmost model.
- *Referenced models* are blocks or models that other models reference, such as models the top-model refers to. Models or blocks below the top-model in the hierarchy are reference models.

The following sections describe briefly how model reference works. More details are available in your Simulink Coder documentation in the online Help system.

Model Reference in Simulation. When you simulate the top-model, Simulink Coder detects that your model contains referenced models. Simulink generates code for the referenced models and uses the generated code to build shared library files for updating the model diagram and simulation. It also creates an executable (.mex file) for each reference model that is used to simulate the top-model.

When you rebuild reference models for simulations or when you run or update a simulation, Simulink software rebuilds the model reference files. Whether reference files or models are rebuilt depends on:

- Whether and how you change the models.
- The **Rebuild** parameter on the **Model Reference** pane in the Configuration Parameters dialog.

Model Reference in Code Generation. Simulink Coder requires executables to generate code from models. If you have not simulated your model at least once, Simulink Coder creates a .mex file for simulation.

Next, for each referenced model, the code generation process calls `make_rtw` and builds each referenced model. This build process creates a library file for each of the referenced models in your model.

After building the referenced models, Simulink Coder calls `make_rtw` on the top-model. The call to `make_rtw` links to the library files Simulink Coder created for the associated referenced models.

Using Model Reference

With few limitations or restrictions, Embedded Coder software provides full support for generating code from models that use model reference.

Build Action Setting. The most important requirement for using model reference with the Green Hills MULTI software supported processors is to set the **Build action** for Model blocks referred to in the simulation to `Archive_library`.

To set the build action, perform the following steps:

- 1 Open your model.
- 2 Select **Simulation > Model Configuration Parameters** from the model menus.

The Configuration Parameters dialog opens.

- 3 In the Configuration Parameters dialog, expand the node for the **Code Generation** pane and select the **Coder Target** pane.
- 4 In the right pane, under **Run-Time**, select `Archive_library` from the **Build action** list.

If your top-model uses a reference model that does not have the build action set to `Archive_library`, the build process automatically changes the build action to `Archive_library` and issues a warning about the change.

Selecting `Archive_library` disables the **Interrupt overrun notification method**, **Export MULTI link handle to the base workspace**, and **System stack size** options for the referenced models.

Other Block Limitations. Model reference with Embedded Coder software code generation options does not allow you to use noninlined S-functions in reference models. Verify that the blocks in your model do not use noninlined S-functions.

Configuring Targets to Use Model Reference

When you create models to use in Model Referencing, keep in mind the following considerations:

- Your model must use a system target file derived from the ERT or GRT target files.
- When you generate code from a model that references other models, configure the top-level model and the referenced models for the same system target file.
- Simulink Coder builds and Embedded Coder software projects do not support External mode in model reference. If you select the External mode option, it is ignored during code generation.
- Your TMF must support use of the shared utilities folder, as described in Supporting Shared Utility Directories in the Build Process in the Simulink Coder documentation.

To use an existing processor, or a new processor, with Model Reference, set the `ModelReferenceCompliant` flag for the processor. For information about setting this option, refer to `ModelReferenceCompliant` in the online Help system.

If you start with a model that was created before MATLAB release R14SP3, use the following command to make your model compatible with model reference :

```
% Set the Model Reference Compliant flag to on.  
set_param(bdroot, 'ModelReferenceCompliant', 'on')
```

Code that you generate from Simulink models by using Embedded Coder software includes the model reference capability. You do not need to set the flag.

Breakpoints and PIL

Green Hills MULTI debugger allows you to add breakpoints to your projects. When you run a PIL simulation that includes added breakpoints, a dialog appears that gives you two options:

- Stop the running simulation by closing the dialog.
- Go to MULTI, remove the breakpoint you added, and press **F5** to continue running your simulation.

Working with Linux Target

- “Disambiguation” on page 41-2
- “Preparing Models to Run on Linux Target” on page 41-3
- “Scheduler” on page 41-4
- “Build on BeagleBoard Hardware” on page 41-13
- “Build on Linux Host and Run on BeagleBoard Hardware” on page 41-15

Disambiguation

This documentation uses the term “Linux” generically to refer to:

- Linux running on a host computer
- Linux running on an target hardware

If the distinction between host and target is important, the documentation will identify the hardware platform on which Linux is running. For example:

- “Embedded Linux” or “Linux running on target hardware”
- “Linux running on a host computer.”

Preparing Models to Run on Linux Target

To build an executable that runs on Linux, perform the following steps:

- 1** Install and configure Eclipse IDE according to the instructions in “Working with Eclipse IDE”.
- 2** Configure your model as described in “Configure Target Hardware Resources” on page 35-3, setting **IDE/Tool Chain** to Eclipse.

This action sets the **Operating System** parameter to Linux and displays the **Linux** tab.

- 3** Select the **Linux** tab.
- 4** Set the **Scheduling Mode** to one of these options:
 - If you select **real-time**, the model uses a timer to trigger the base rate at regular periods.
 - If you select **free-running**, the model does not use a timer. Instead, the model completes each process or thread before running the next one.
- 5** For Linux, you can set the **Base Rate Priority** relative to other processes and threads. You can enter values from (the number of rates + 1) to 99.
- 6** Configure the model to build and execute:
 - a** In the model, select **Simulation > Model Configuration Parameters**.
 - b** Under **Code Generation**, select the **Coder Target** pane.
 - c** Set **Build action** to **Build and execute**.

- 7** Click **Build Model**  on the model tool strip.

After the build completes, Embedded Coder software downloads the executable to the remote system and runs it.

Scheduler

In this section...
“Base Rate” on page 41-4
“Running Target Applications on Multicore Processors” on page 46-10
“Avoiding Lock-Up in Free-Running, Multirate, Multitasking Models” on page 41-11

Base Rate

The base rate in the model maps to a thread and runs as fast as possible. The base rate priority selection in the OS tab allows you to set a static priority for the base rate task. By default, this rate is 40.

The process running single-tasking models has Default scheduling policy when model is single-tasking or there is a single rate in the model. Static priority of the process is 0 in this case.

Running Target Applications on Multicore Processors

Introduction

This section provides a variation of the process described in “Build and Download to a Multicore Target”.

This section shows you how to:

- Configure a multirate model
- Generate a multithreaded application from that model

So that the resulting application is enabled for concurrent multicore execution on an embedded target running Linux or VxWorks.

This process uses the `idelink_ert.tlc` or `idelink_grt.tlc` system target files, which enable you to:

- Use Embedded Coder Support Package for Xilinx Zynq-7000 Platform to automatically build, download, and run an executable in the Linux environment on the ARM Cortex-A9 processor on the Xilinx Zynq-7000 platform. (makefile-based)
- Use Eclipse IDE to manage projects for Linux targets (Support for this capability is only available on 32-bit host platforms)
- Cross-compile from a Windows host to a Linux target
- Set thread priority using the **Base rate task priority** parameter on the Target Hardware Resources tab.
- Use VxWorks

Note

- For Xilinx Zynq-7000 platform, see “Working with the Xilinx Zynq-7000 Platform”.
- For VxWorks, see “Building and Running Embedded Software on VxWorks Target” on page 46-4.

Looking at a Model

Before setting up your own model, consider the `sldemo_concurrent_execution` example model, which is referenced by “Build and Download to a Multicore Target”.

The `sldemo_concurrent_execution` model is a useful example to look at because:

- The model is partitioned using Model blocks that can potentially execute concurrently.
- You can look at the **Map Blocks To Tasks** pane in the Concurrent Execution window to see how the tasks are configured for concurrent execution.

However, you cannot run an unmodified version of the `sldemo_concurrent_execution` model on an embedded target running Linux or VxWorks.

To prepare the `sldemo_concurrent_execution` as an example model for the “Setting Up the Model” on page 46-13 and “Deploying the Model to Your Target” on page 46-14 topics, first perform the following modifications:

- Update the Plant Model Block
- Update the Compensator Model Block
- Verify that Models are Mapped

These procedures guide you through the processes of discretizing models and matching sample times of blocks with models.

Update the Plant Model Block.

- 1** In the `sldemo_concurrent_execution` model, open the “Plant” Model block: `sldemo_concurrent_execution_plant`
- 2** Discretize the Plant model. Replace the Integrator blocks, “x1” and “x2”, with equivalent discrete time blocks (such as the Discrete Time Integrator block) or use the “Model Discretizer”.
- 3** Prevent modeling constraints by matching the sample time of the “x1” and “x2” blocks with the model: Open the “x1” and “x2” blocks and change the **Sample time** parameters to 0.1. Matching the sample times to the model can also be accomplished using Rate Transition blocks.
- 4** Convert blocks with continuous sample times (**Sample time** = 0) to inherited sample times (**Sample time** = -1). Open the “u1”, “u2” and “x” blocks. For each one, click the Signal Attributes tab, then change **Sample time** to -1.
- 5** Save your changes to the blocks and the model.

Update the Compensator Model Block.

- 1 In the `sldemo_concurrent_execution` model, open the “Compensator” Model block: `sldemo_concurrent_execution_compensator`
- 2 Discretize the Compensator model. Replace the Integrator block, “c”, with an equivalent discrete time block (such as the Discrete Time Integrator block) or use the “Model Discretizer”.
- 3 Prevent modeling constraints by matching the sample time of the “c” block with the top model: Open the “c” block and change the **Sample time** parameters to 0.1. Matching the sample times to the top model, `sldemo_concurrent_execution`, can also be accomplished using Rate Transition blocks.
- 4 Convert blocks with continuous sample times (**Sample time** = 0) to inherited sample times (**Sample time** = -1). Open the “y1”, “y2”, and “x” blocks. For each one, click the Signal Attributes tab, then change **Sample time** to -1.
- 5 The following parameters cannot both be enabled when you build the model. Open the Configuration Parameters (**Ctrl+E**) and verify that one of the following parameters is disabled (unchecked):
 - **Minimize algebraic loop occurrences**, located on the Model Referencing pane.
 - **Single output/update function**, located on the Code Generation > Interface pane
- 6 Save your changes to the blocks and the model.

Verify that the Models are Mapped. Open and inspect the Task editor to see if the models are mapped:

- 1 In the Simulink model editor for `sldemo_concurrent_execution`, select **View > Model Explorer (Ctrl + H)**.
- 2 In Model Explorer, expand the top model, `sldemo_concurrent_execution`.

- 3** Under the top model, select **Configuration (Active)**, then click **Concurrent Execution** in the second column. In the third column, click the **ConfigureTasks and Map Blocks to Tasks** button.
- 4** Click **Map Blocks To Tasks**. The mapping of the models should conform to the guidelines provided by “Design Considerations”.

The `sldemo_concurrent_execution` example model is ready for you to use in “Setting Up the Model” on page 46-13 and “Deploying the Model to Your Target” on page 46-14.

Setting Up the Model

This procedure explains how to set up a model for a multicore processor.

- 1** Apply the recommendations in “Design Considerations” to your multirate Simulink model. Or, refer to the `sldemo_concurrent_execution` example model.
- 2** Configure your model for your IDE, tool chain, and target hardware, as described in “Configure Target Hardware Resources” on page 35-3.
- 3** In Configuration Parameters, set the **Operating System** parameter to Linux or VxWorks.
- 4** If your model uses a Rate Transition block to transition between rates, then open the Rate Transition block and clear the **Ensure deterministic data transfer** check box so that the block uses the most recent data available.
- 5** Configure the model for concurrent execution:
 - a** In the Simulink model editor, select **View > Model Explorer (Ctrl + H)**.
 - b** In Model Explorer, expand the top model.
 - c** Under the top model, right click **Configuration (Active)** and select **Convert to Configuration for Concurrent Execution**. (In the `sldemo_concurrent_execution` example model, this step has already been performed.)
- 6** Repeat steps 4 through 5 for each referenced model in the model hierarchy that you want to run with concurrent execution.

- 7 Select the configuration set of the model at the top of the model hierarchy. In the second column, select the **Concurrent Execution** node. A Concurrent Execution pane appears in the third column. (In the `sldemo_concurrent_execution` example model, this step has already been performed.)
- 8 In the Concurrent Execution pane in the third column, select the **This is the top of the model hierarchy** check box, and click the **ConfigureTasks and Map Blocks to Tasks** button. (In the `sldemo_concurrent_execution` example model, this step has already been performed.)
- 9 The Concurrent Execution configuration parameters dialog is displayed. Click **Apply**.

Deploying the Model to Your Target

In your model, click the build button or enter **Ctrl+B**. The software performs the actions you selected for **Build action** in the Configuration Parameters dialog, on the Code Generation > Coder Target pane.

For more information on the structure of the code, please refer to “Build and Download to a Multicore Target”. As mentioned in that section, the coder product generates target-dependent code for thread creation, thread synchronization, interrupt service routines, and signal handlers and data transfer. For each periodic task, Simulink Coder combines the output and update methods of the blocks mapped to that task and binds these methods to a target-specific thread.

Note The `idelink_ert.tlc` or `idelink_grt.tlc` system target files do not support Continuous times.

Generated Code

For `idelink_ert.tlc` or `idelink_grt.tlc` system target files, the generated code from a mapped model creates a thread for each task and automatically leverages the threading APIs supported by the operating system running on the target.

- If the target platform is running Windows , the generated code will use Windows threads.
- If the target platform is running Linux or VxWorks , the generated code will use POSIX® threads (pthreads).

The following table summarizes the differences in the generated code between the target platforms.

Aspect of Concurrent Execution	Linux	VxWorks
Periodic triggering event	POSIX timer	POSIX timer
Aperiodic triggering event	POSIX real-time signal	POSIX real-time and non-real-time signal
Aperiodic trigger	For blocks mapped to an aperiodic task: thread waiting for a signal For blocks mapped to an aperiodic trigger: signal action	For blocks mapped to an aperiodic task: thread waiting for a signal. For blocks mapped to an aperiodic trigger: signal action
Threads	POSIX	POSIX
Thread priority	Based on Base rate task priority parameter	Based on Base rate task priority parameter
Example of overrun detection	Yes	Yes

The software checks that data transfer between concurrently executing tasks behave as described in Data Transfer Options. The software checks data transfer using the following APIs on supported targets.

API	Linux Implementation	VxWorks
Data protection API	<ul style="list-style-type: none"> • pthread_mutex_init • pthread_mutex_destroy • pthread_mutex_lock • pthread_mutex_unlock 	<ul style="list-style-type: none"> • pthread_mutex_init • pthread_mutex_destroy • pthread_mutex_lock • pthread_mutex_unlock
Synchronization API	<ul style="list-style-type: none"> • sem_init • sem_destroy • sem_wait • sem_post 	<ul style="list-style-type: none"> • sem_open • sem_unlink • sem_wait • sem_post

Avoiding Lock-Up in Free-Running, Multirate, Multitasking Models

This section applies when the following conditions are true:

- The model is a multirate multitasking model
- In Configuration Parameters, on the **Code Generation > Coder Targets > Target Hardware Resources** pane, the **Operating system** parameter is set to Linux and the **Scheduling Mode** parameter is set to free-running.

Because of the rate monotonic scheduling requirement in Linux, the scheduler runs threads with a SCHED_FIFO scheduling policy. While it is ready to run, a process scheduled with SCHED_FIFO prevents other processes from running. Therefore, if the model does not contain blocking peripherals, the entire Linux system can become unresponsive while you are running the generated code. Such lock-up can even preempt the shell window from running. To avoid this lock-up, apply one of the following solutions:

- Set **Scheduling Mode** to real_time.
- In your model, include a blocking device driver such as a UDP block. Blocking devices suspend running threads while data is not available.

- Raise the shell window priority above the base-rate priority so you can kill the process running with SCHED_FIFO class.

Build on BeagleBoard Hardware

In this section...

“Overview” on page 41-13

“Configure the Windows Host” on page 41-13

“Configure the BeagleBoard Hardware” on page 41-13

“Configure MATLAB Software” on page 41-14

Overview

This example shows you how to generate code on a Windows host, and then build it remotely on a BeagleBoard hardware running Linux.

Configure the Windows Host

Download and install the following PuTTY utilities from <http://www.chiark.greenend.org.uk/~sgtatham/putty/download>:

- Plink (a command-line interface to the PuTTY back ends)
- PSCP (an SCP client)

Warning PuTTY software may be illegal in countries where encryption is prohibited.

Configure the BeagleBoard Hardware

Install the GNU-compiler toolchain on the BeagleBoard. Open a terminal session with the Linux command line on the BeagleBoard.

For example, on a board running the Angstrom Linux distribution, enter the following commands:

```
root@beagleboard:~# opkg install binutils
root@beagleboard:~# opkg install gcc
root@beagleboard:~# opkg install gcc-symlinks
root@beagleboard:~# opkg install cpp-symlinks
root@beagleboard:~# opkg install libstdc++-dev
root@beagleboard:~# opkg install make-dev
```

Configure MATLAB Software

Configure MATLAB software to generate code.

- 1** Enter `xmakefilesetup` in the MATLAB Command Window. In the XMakefile Configuration dialog, set **template** to `gmake` and **configuration** to `gcc_target`.
- 2** Configure your model for your IDE, tool chain, and target hardware, as described in “Configure Target Hardware Resources” on page 35-3, setting **IDE/Toolchain** to Eclipse, set **Board** to BeagleBoard ARM, and set **Operating System** to Linux.
- 3** Under the Tool Chain Automation tab, set **Build format** to Makefile, and set **Build Action** to `Create_makefile`.
- 4** Generate the code by pressing **Ctrl+B**.
- 5** Use `remoteBuild` function to build the code on the BeagleBoard hardware. For example, enter:

```
remoteBuild('modelName', '/home/root', '144.212.110.193',  
            'root', 'password', 'C:\utils\putty')
```

The GNU compiler toolchain automatically builds and runs the software on the BeagleBoard hardware.

For more information, see `remoteBuild`.

Build on Linux Host and Run on BeagleBoard Hardware

In this section...

“Overview” on page 41-15

“Prerequisites” on page 41-15

“Set up your environment for Linux-ARM Code Generation” on page 41-15

“Generate Code for Linux-ARM” on page 41-18

“External Mode Simulation” on page 41-18

Overview

This example shows you how to build a target application locally on a Linux host using Eclipse IDE, and then run the program remotely on the ARM processor of a BeagleBoard hardware running Angstrom Linux.

Prerequisites

To generate code for BeagleBoard hardware, first obtain and install the following third-party software:

- Eclipse™ IDE
- OpenEmbedded build system for BeagleBoard Angstrom

You can find instructions for installing Eclipse IDE here: “Working with Eclipse IDE”

You can find instructions for building BeagleBoard OpenEmbedded here: The Angstrom Distribution

Set up your environment for Linux-ARM Code Generation

Before attempting to generate code for BeagleBoard hardware, it is important to configure your environment. Use the following configuration steps to generating code for the Linux-ARM target on the BeagleBoard hardware. These instructions assume you have already built the OpenEmbedded

Linux-Angstrom distribution. Make sure that you build the bitbake recipe for `gdb-cross` and install `gdbserver` on the target board. For example, use the `bitbake gdb-cross` command to build the GDB debugger that runs on your host computer. Then use `opkg` to install `gdbserver`. For example, enter: `opkg install gdbserver`. The Eclipse project generated by the coder product uses local GDB debugger and a GDB server running on the target board to enable debugging support. You also need an Ethernet connection to your board to debug the generated code.

- 1** Set up your MATLAB environment to see OpenEmbedded GNU compiler toolchain and the OpenEmbedded root file system by entering the following in a MATLAB Command Window:

```
setenv('PATH', ['<pathtoOETree>/oe/angstrom-dev/cross/armv7a/bin' ':' getenv('PATH')])
setenv('OETREE', '<pathtoOETree>/oe')
```

The first `setenv` command adds the path to the GNU compiler toolchain for MATLAB to locate compiler, linker, and so on, for the BeagleBoard hardware. Internally, MATLAB uses `OETREE` environment variable to locate the root file system of the BeagleBoard hardware and shared libraries used for linking. Folder information extracted from `OETREE` environment variable is used to set up the GDB initialization script.

- 2** Enter `eclipseidesetup` in the MATLAB Command Window. In the Eclipse Adaptor Setup dialog that opens, set the parameters as shown here.

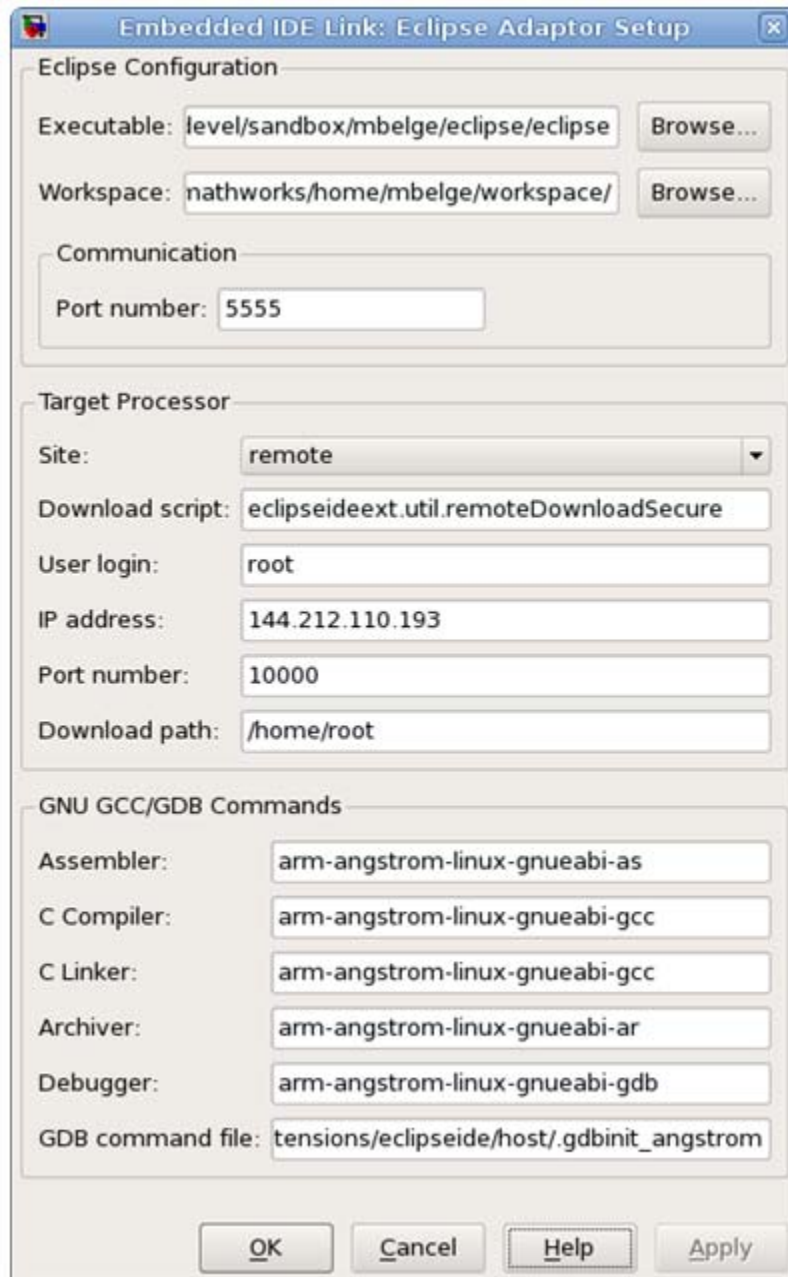

Embedded IDE Link: Eclipse Adaptor Setup

Eclipse Configuration

Executable:

Workspace:

Communication

Port number:

Target Processor

Site: ▾

Download script:

User login:

IP address:

Port number:

Download path:

GNU GCC/GDB Commands

Assembler:

C Compiler:

C Linker:

Archiver:

Debugger:

GDB command file:

In the Target Processor pane, enter the **IP address** of your board. Set **Download script** to `eclipseideext.util.remoteDownloadSecure`, and set **GDB command file** to `$(MATLAB_ROOT)/toolbox/idelink/extensions/eclipseide/host/.gdbinit_angstrom`.

Generate Code for Linux-ARM

- 1 Enter `sumdiff_codegen` in the MATLAB Command Window. This opens the `sumdiff_codegen` model.
- 2 Configure your model for your IDE, tool chain, and target hardware, as described in “Configure Target Hardware Resources” on page 35-3, setting **IDE/Toolchain** to Eclipse, set **Board** to BeagleBoard ARM, and set **Operating System** to Linux.
- 3 In the Compiler options string edit box enter `-mfloat-abi=softfp`. This option is an Angstrom distribution-specific compiler option required to generate floating point code for BeagleBoard hardware.
- 4 Generate and build the ARM code. If the build process is complete, the code starts running on the board automatically.
- 5 You can, alternatively, run the generate code by downloading to the target file system. On a Linux command shell, you can execute the following:

```
> scp <pathtoarmexecutable>/sumdiff_codegen root@10.10.10.1:/home/root/.  
> ssh root@10.10.10.1 /home/root/sumdiff_codegen
```

External Mode Simulation

- 1 To run the simulation in External mode, connect a scope to Out1 port on the `sumdiff_codegen` model. Open Simulation -> Configuration Parameters -> Code Generation -> Interface dialog. Enter the IP address of the BeagleBoard hardware in the MEX-file Arguments edit box under Host/Target interface. The IP address of the board is required for External mode TCP/IP connection. If the IP address of your board is 10.10.10.1, for example, enter '10.10.10.1' in the MEX-file Arguments edit box. Click OK and close the dialog.

- 2** Click Simulation -> Connect To Target (Ctrl-T) to establish External mode connection.
- 3** Double click the Simulink Scope and examine the data retrieved from Linux-ARM target. The scope should display zeros.

Working with Texas Instruments Code Composer Studio 3.3 IDE

- “Code Composer Studio” on page 42-2
- “Getting Started” on page 42-4
- “IDE Automation Interface” on page 42-9
- “IDE Project Generator” on page 42-58
- “Exporting Filter Coefficients from FDATool” on page 42-69
- “Using Makefiles with Code Composer Studio 3.x” on page 42-87
- “Reported Limitations and Tips” on page 42-92

Code Composer Studio

In this section...

“Using Code Composer Studio with Embedded Coder Software” on page 42-2

“Default Project Configuration” on page 42-2

Using Code Composer Studio with Embedded Coder Software

Texas Instruments (TI) facilitates development of software for TI DSPs by offering Code Composer Studio (CCS) Integrated Development Environment (IDE). Used in combination with Embedded Coder software and Simulink Coder software, CCS provides an integrated environment that, once installed, does not require coding.

Executing code generated from Simulink Coder software on a particular target requires that you tailor the code to the specific hardware target. Target-specific code includes I/O device drivers and interrupt service routines (ISRs). The software must use CCS to compile and link the generated source code in order to load and execute on a TI DSP. To help you to build an executable, Embedded Coder software uses Embedded Coder software to start the code building process within CCS. After you download your executable to your target and run it, the code runs wholly on the target hardware. You can access the running process only from the CCS debugging tools or across a link using Embedded Coder software. A wide range of Texas Instruments DSPs are supported:

- TI's C2000™
- TI's C5000™
- TI's C6000™

Default Project Configuration

CCS offers two standard project configurations, **Release** and **Debug**. Project configurations define sets of project build options. When you specify the build options at the project level, the options apply to the files in your project. For more information about the build options, refer to your TI documentation. The

models you build with Embedded Coder software use a custom configuration that provides a third combination of build and optimization settings — CustomMW.

Default Build Options in the CustomMW Configuration

The default settings for CustomMW are the same as the Release project configuration in CCS, except for the compiler options.

Your CCS documentation provides complete details on the compiler build options. You can change the individual settings or the build configuration within CCS.

Getting Started

In this section...
“Overview” on page 42-4
“Verifying Your Code Composer Studio Installation” on page 42-7

Overview

- “IDE Automation Interface” on page 42-5
- “IDE Project Generator” on page 42-6
- “Verification” on page 42-7

Embedded Coder software enables you to use MATLAB functions to communicate with Code Composer Studio software and with information stored in memory and registers on a processor. With the `ticcs` objects, you can transfer information to and from Code Composer Studio software and with the embedded objects you get information about data and functions stored in your signal processor memory and registers, as well as information about functions in your project.

Embedded Coder lets you build, test, and verify automatically generated code using MATLAB, Simulink, Simulink Coder, and the Code Composer Studio integrated development environment. You can use Embedded Coder to verify code executing within the Code Composer Studio software environment using a model in Simulink software. This processor-in-the-loop testing environment uses code automatically generated from Simulink models by Embedded Coder software. A range of Texas Instruments targets are supported:

- TI's C2000
- TI's C5000
- TI's C6000

With Embedded Coder , you can use MATLAB software and Simulink software to interactively analyze, profile and debug processor-specific code execution behavior within CCS. In this way, Embedded Coder automates

deployment of the complete embedded software application and makes it easy for you to assess possible differences between the model simulation and processor code execution results.

Embedded Coder consists of these components:

- IDE Project Generator—add embedded framework code to the C code generated from Simulink models, and package as a complete IDE project
- IDE Automation Interface—use functions in the MATLAB command window to access and manipulate data and files in the IDE and on the processor
- Verification—verify how your programs run on your processor

With Embedded Coder, you create objects that connect MATLAB software to Code Composer Studio software.

Note Embedded Coder uses objects. You work with them the way you use other MATLAB objects. You can set and get their properties, and use their methods to change them or manipulate them and the IDE to which they refer.

The next sections describe briefly the components of Embedded Coder software.

IDE Automation Interface

The IDE Automation Interface component is a collection of methods that use the Code Composer Studio API to communicate between MATLAB software and Code Composer Studio. With the interface, you can do the following:

- Automate complex tasks in the development environment by writing MATLAB software scripts to communicate with the IDE, or debug and analyze interactively in a live MATLAB software session.
- Automate debugging by executing commands from the powerful Code Composer Studio software command language.
- Exchange data between MATLAB software and the processor running in Code Composer Studio software.

- Set breakpoints, step through code, set parameters and retrieve profiling reports.
- Automate project creation, including adding source files, include paths, and preprocessor defines.
- Configure batch building of projects.
- Debug projects and code.
- Execute API Library commands.

The IDE Automation Interface provides an application program interface (API) between MATLAB software and Code Composer Studio. Using the API, you can create new projects, open projects, transfer data to and from memory on the processor, add files to projects, and debug your code.

IDE Project Generator

The IDE Project Generator component is a collection of methods that use the Code Composer Studio API to create projects in Code Composer Studio and generate code with Embedded Coder. With the interface, you can do the following:

- Automated project-based build process
Automatically create and build projects for code generated by Embedded Coder.
- Customize code generation
Use Embedded Coder with a Embedded Coder system target file (STF) to generate processor-specific and optimized code.
- Customize the build process
- Automate code download and debugging
Rapidly and effortlessly debug generated code in the Code Composer Studio software debugger, using either the instruction set simulator or real hardware.
- Create and build CCS projects from Simulink software models. IDE Project Generator uses Simulink Coder software or Embedded Coder software to build projects that work with C2000 software, C5000 software, and C6000 software processors.

- Highly customized code generation with the system target file `idelink_ert.tlc` and `idelink_grt.tlc` that enable you to use the Configuration Parameters in your model to customize your generated code.
- Automate the process of building and downloading your code to the processor, and running the process on your hardware.

Verification

Verifying your processes and algorithms is an essential part of developing applications. The components of Embedded Coder combine to provide the following verification tools for you to apply as you develop your code:

- Processor-in-the-loop simulation (PIL)
- Execution profiling
- Stack profiling

Verifying Your Code Composer Studio Installation

To verify that CCS is installed on your machine and has at least one board configured, enter

```
ccsboardinfo
```

in the MATLAB Command Window. With CCS installed and configured, MATLAB software returns information about the boards that CCS recognizes on your machine, in a form similar to the following listing.

Board Num	Board Name	Proc Num	Processor Name	Processor Type
1	C6xxx Simulator (Texas Instrum	.0	6701	TMS320C6701
0	C6x13 DSK (Texas Instruments)	0	CPU	TMS320C6x1x

If MATLAB software does not return information about boards, open your CCS installation and use the Setup Utility in CCS to configure at least one board.

As a final test, start CCS to verify that it runs. For Embedded Coder to operate with CCS, the CCS IDE must be able to run on its own.

Embedded Coder uses objects to create:

- Connections to the Code Composer Studio Integrated Development Environment (CCS IDE)
- Connections to the RTDX™ (RTDX) interface. This object is a subset of the object that refers to the CCS IDE.

Concepts to know about the objects in this toolbox are covered in these sections:

- “Constructing ticcs Objects” on page 42-48
- “ticcs Properties and Property Values” on page 42-49
- “Overloaded Functions for ticcs Objects” on page 42-50

Refer to MATLAB Classes and Objects in your MATLAB documentation for more details on object-oriented programming in MATLAB software.

Many of the objects use COM server features to create handles for working with the objects. Refer to your MATLAB documentation for more information about COM as used by MATLAB software.

IDE Automation Interface

In this section...

“Getting Started with IDE Automation Interface” on page 42-9

“Getting Started with RTDX” on page 42-27

“Constructing ticcs Objects” on page 42-48

“ticcs Properties and Property Values” on page 42-49

“Overloaded Functions for ticcs Objects” on page 42-50

“ticcs Object Properties” on page 42-50

Getting Started with IDE Automation Interface

- “Introducing the IDE Automation Interface” on page 42-9
- “Selecting Your Processor” on page 42-13
- “Creating and Querying Objects for CCS IDE” on page 42-15
- “Loading Files into CCS” on page 42-17
- “Working with Projects and Data” on page 42-19
- “Closing the Links or Cleaning Up CCS IDE” on page 42-25

Introducing the IDE Automation Interface

Embedded Coder provides a connection between MATLAB software and a processor in CCS. You can use objects to control and manipulate a signal processing application using the computational power of MATLAB software. This approach can help you debug and develop your application. Another possible use for automation is creating MATLAB scripts that verify and test algorithms that run in their final implementation on your production processor.

Before using the functions available with the objects, you must select a processor because objects you create are specific to a designated processor and a designated instance of CCS IDE. For multiprocessor boards or multiple board configurations of CCS, select the specific processor.

When you have one board with a single processor, the object defaults to the existing processor. For the objects, the simulator counts as a board; if you have both a board and a simulator that CCS recognizes, you must specify the processor explicitly.

To get you started using objects for CCS software, Embedded Coder includes a tutorial that introduces you to working with data and files. As you work through this tutorial, you perform the following tasks that step you through creating and using objects for CCS IDE:

- 1** Select your processor.
- 2** Create and query objects to CCS IDE.
- 3** Use MATLAB software to load files into CCS IDE.
- 4** Work with your CCS IDE project from MATLAB software.
- 5** Close the connections you opened to CCS IDE.

The tutorial provides a working process (a *workflow*) for using Embedded Coder and your signal processing programs to develop programs for a range of Texas Instruments processors.

During this tutorial, you load and run a digital signal processing application on a processor you select. The tutorial shows both writing to memory and reading from memory in the “Working with Projects and Data” on page 42-19” portion of the tutorial.

You can use the `read` and `write` methods, as described in this tutorial, to read and write data to and from your processor.

The tutorial covers the object methods and functions for Embedded Coder. The functions listed in the first table apply to CCS IDE independent of the objects — you do not need an object to use these functions. The methods listed in the second and third table requires a `ticcs` object that you use in the method syntax:

Functions for Working With Embedded Coder. The following functions do not require a `ticcs` object as an input argument:

Function	Description
<code>ccsboardinfo</code>	Return information about the boards that CCS IDE recognizes as installed on your PC.
<code>ticcs</code>	Construct an object to communicate with CCS IDE. When you construct the object you specify the processor board and processor.

Methods for Working with ticcs Objects. The methods in the following table require a `ticcs` object as an input argument:

Method	Description
<code>add</code>	Add files to active project in IDE.
<code>address</code>	Memory address and page value of symbol in IDE.
<code>build</code>	Build or rebuild current project.
<code>display (IDE Object)</code>	Display the properties of an object to CCS IDE and RTDX.
<code>halt</code>	Terminate execution of a process running on the processor.
<code>info</code>	Return information about the processor or information about open RTDX channels.
<code>insert</code>	Insert debug point in file.
<code>isrtdxcapable</code>	Test whether your processor supports RTDX communications.
<code>isvisible</code>	Determine whether IDE appears on desktop.
<code>isrunning</code>	Test whether the processor is executing a process.
<code>list</code>	Return various information listings from Code Composer Studio software.

Method	Description
load	Load program file onto processor.
read	Retrieve data from memory on the processor.
regread	Read values from processor registers.
regwrite	Write data values to registers on processor.
remove	Remove file, project, or breakpoint.
restart	Restore the program counter (PC) to the entry point for the current program.
run	Execute the program loaded on the processor.
visible	Set whether CCS IDE window is visible on the desktop while CCS IDE is running.
write	Write data to memory on the processor.

Running Code Composer Studio Software on Your Desktop – Visibility. When you create a `ticcs` object, Embedded Coder starts CCS in the background.

When CCS IDE is running in the background, it does not appear on your desktop, in your task bar, or on the **Applications** page in the Task Manager. It does appear as a process, `cc_app.exe`, on the **Processes** tab in Microsoft Windows Task Manager.

You can make the CCS IDE visible with the function `visible`. The function `invisible` returns the status of the IDE—whether it is visible on your desktop. To close the IDE when it is not visible and MATLAB software is not running, use the **Processes** tab in Microsoft Windows Task Manager and look for `cc_app.exe`.

If a link to CCS IDE exists when you close CCS, the application does not close. Microsoft Windows software moves it to the background (it becomes invisible). Only after you clear links to CCS IDE, or close MATLAB software, does closing CCS IDE unload the application. You can see if CCS IDE is running in the background by checking in the Microsoft Windows Task Manager. When CCS IDE is running, the entry `cc_app.exe` appears in the **Image Name** list on the **Processes** tab.

When you close MATLAB software while CCS IDE is not visible, MATLAB software closes CCS if it started the IDE. This happens because the operating system treats CCS as a subprocess in MATLAB software when CCS is not visible. Having MATLAB software close the invisible IDE when you close MATLAB software prevents CCS from remaining open. You do not need to close it using Microsoft Windows Task Manager.

If CCS IDE is not visible when you open MATLAB software, closing MATLAB software leaves CCS IDE running in an invisible state. MATLAB software leaves CCS IDE in the visibility and operating state in which it finds it.

Interactive Learning. You have the option of running this tutorial from the MATLAB Command Window or entering the functions as described in the following tutorial sections.

To run the tutorial in MATLAB software, click `run ccstutorial`. This command opens the tutorial in an interactive mode where the tutorial program provides prompts and text descriptions to which you respond to move to the next portion of the lesson. The interactive tutorial covers the same information provided by the following tutorial sections. You can view the tutorial file by clicking `ccstutorial.m`.

Selecting Your Processor

Links for CCS IDE provides two tools for selecting a board and processor in multiprocessor configurations. One is a command line tool called `ccsboardinfo` which prints a list of the available boards and processors. So that you can use this function in a script, `ccsboardinfo` can return a MATLAB software structure that you use when you want your script to select a board without your help.

Note The board and processor you select is used throughout the tutorial.

- 1 To see a list of the boards and processors installed on your PC, enter the following command at the MATLAB software prompt:

```
ccsboardinfo
```

MATLAB software returns a list that shows you the boards and processors that CCS IDE recognizes as installed on your system.

- 2 To use the Selection Utility, `boardprocse1`, to select a board, enter

```
[boardnum,procnum] = boardprocse1
```

When you use `boardprocse1`, you see a dialog similar to the following. Note that some entries vary depending on your board set.

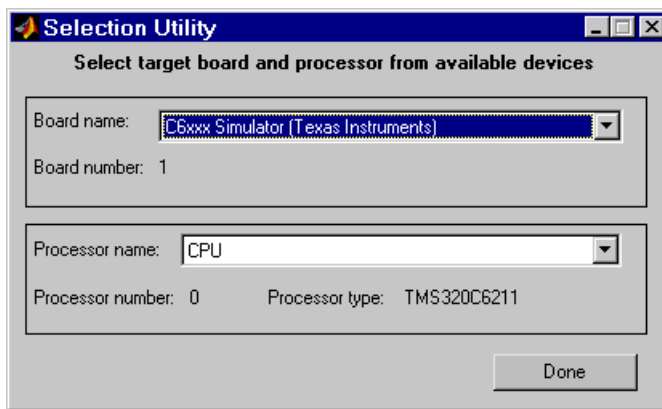

- 3 Select a board name and processor name from the lists.

You are selecting a board and processor number that identifies your particular processor. When you create the object for CCS IDE in the next section of this tutorial, the selected board and processor become the processor of the object.

- 4 Click **Done** to accept your board and processor selection and close the dialog.

boardnum and procnum now represent the **Board name** and **Processor name** you selected — boardnum = 1 and procnum = 0

Creating and Querying Objects for CCS IDE

In this tutorial section, you create the connection between MATLAB software and CCS IDE. This connection, or object, is a MATLAB software object that you save as variable `IDE_Obj`.

You use function `ticcs` to create objects. When you create objects, `ticcs` input arguments let you define other object property values, such as the global timeout. Refer to the `ticcs` reference documentation for more information on these input arguments.

Use the generated object `IDE_Obj` to direct actions to your processor. In the following tasks, `IDE_Obj` appears in function syntax that interacts with CCS IDE and the processor:

- 1 Create an object that refers to your selected board and processor. Enter the following command at the prompt.

```
IDE_Obj=ticcs('boardnum',boardnum,'procnum',procnum)
```

If you were to watch closely, and your machine is not too fast, you see Code Composer Studio software appear briefly when you call `ticcs`. If CCS IDE was not running before you created the new object, CCS starts and runs in the background.

- 2 Enter `visible(IDE_Obj,1)` to force CCS IDE to be visible on your desktop.

Usually, you need to interact with Code Composer Studio software while you develop your application. The first function in this tutorial, `visible`, controls the state of CCS on your desktop. `visible` accepts Boolean inputs that make CCS either visible on your desktop (input to `visible` = 1) or invisible on your desktop (input to `visible` = 0). For this tutorial, use `visible` to set the CCS IDE visibility to 1.

- 3 Next, enter `display(IDE_Obj)` at the prompt to see the status information.

```
TICCS Object:
  Processor type   : Cxx
  Processor name   : CPU
  Running?        : No
  Board number     : 0
  Processor number : 0
  Default timeout  : 10.00 secs

  RTDX channels    : 0
```

Embedded Coder provides methods to read the status of a board and processor:

- `info` — Return a structure of testable board conditions.
- `display` — Print information about the processor.
- `isrunning` — Return the state (running or halted) of the processor.
- `isrtdxcapable` — Return whether the hardware supports RTDX.

4 Type `linkinfo = info(IDE_Obj)`.

The `IDE_Obj` link status information provides information about the hardware as follows:

```
linkinfo =
    procname: 'CPU_1'
    isbigendian: 0
    isrtdxcapable: 0
        family: 320
        subfamily: 103
        revfamily: 11
    targettype: 'simulator'
    siliconrev: 0
        timeout: 10
    boardname: 'Cxxxx Device Simulator'
```

5 Check whether the processor is running by entering

```
runstatus = isrunning(IDE_Obj)
```

MATLAB software responds, indicating that the processor is stopped, as follows:

```
runstatus =  
  
    0
```

- 6 At last, verify that the processor supports RTDX communications by entering

```
usesrtdx = isrtdxcapable(IDE_Obj)  
usesrtdx =  
  
    1
```

Loading Files into CCS

You have established the connection to a processor and board and have created and queried objects. Next, the processor needs something to do.

In this part of the tutorial, you load the executable code for the processor CPU in CCS IDE. Embedded Coder includes a CCS project file. Through the next tasks in the tutorial, you locate the tutorial project file and load it into CCS IDE. The `open` method directs CCS to load a project file or workspace file.

Note CCS has workspace and workspace files that are different from the MATLAB workspace files and workspace. Remember to monitor both workspaces.

After you have executable code running on your processor, you can exchange data blocks with it. Exchanging data is the purpose of the objects provided by Embedded Coder software.

- 1 To load the project file to your processor, enter the following command at the MATLAB software prompt. `getdemoproject` is a specialized function for loading Embedded Coder example files. It is not supported as a standard Embedded Coder function.

```
demobjt= getDemoProject(IDE_Obj,'ccstutorial')
```

```
demoPjt.ProjectFile

ans =

C:\Temp\EmbIDELinkCCDemos_v4.1\ccstutorial\cxx\cxxx\ccstut.pjt

demoPjt.DemoDir

ans =

C:\Temp\EmbIDELinkCCDemos_v4.1\ccstutorial\cxx\cxxx
```

Your paths may be different if you use a different processor. Note where the software stored the example files on your machine. In general, Embedded Coder software stores the example project files in

```
EmbIDELinkCCDemos_v#.#
```

Embedded Coder creates this folder in a location where you have write permission. There are two locations where Embedded Coder software tries to create the example folder, in the following order:

- a** In a temporary folder on your C drive, such as `C:\temp\`.
 - b** If Embedded Coder software cannot use the `temp` folder, you see a dialog that asks you to select a location to store the examples.
- 2** Enter the following command at the MATLAB command prompt to build the processor executable file in CCS IDE.

```
build(IDE_Obj, 'all', 20)
```

You may get an error related to one or more missing `.lib` files. If you installed CCS IDE in a folder other than the default installation folder, browse in your installation folder to find the missing file or files. Refer to the path in the error message as an indicator of where to find the missing files.

- 3** Change your working folder to the example folder and enter `load(IDE_Obj, 'projectname.out')` to load the processor execution file, where *projectname* is the tutorial you chose, such as `ccstut_67x`.

You have a loaded program file and associated symbol table to the IDE and processor.

- 4 To determine the memory address of the global symbol `ddat`, enter the following command at the prompt:

```
ddata = address(IDE_Obj, 'ddat')  
ddata =
```

```
1.0e+009 *  
2.1475      0
```

Your values for `ddata` may be different depending on your processor.

Note The symbol table is available after you load the program file into the processor, not after you build a program file.

- 5 To convert `ddata` to a hexadecimal string that contains the memory address and memory page, enter the following command at the prompt:

```
dec2hex(ddata)
```

MATLAB software displays the following response, where the memory page is `0x00000000` and the address is `0x80000010`.

```
ans =  
  
80000010  
00000000
```

Working with Projects and Data

After you load the processor code, you can use Embedded Coder functions to examine and modify data values in the processor.

When you look at the source file listing in the CCS IDE Project view window, there should be a file named `ccstut.c`. Embedded Coder ships this file with the tutorial and includes it in the project.

`ccstut.c` has two global data arrays — `ddat` and `idat` — that you declare and initialize in the source code. You use the functions `read` and `write` to access these processor memory arrays from MATLAB software.

Embedded Coder provides three functions to control processor execution — `run`, `halt`, and `restart`.

- 1** To see these commands, use the following function to add a breakpoint to line 68 of `ccstut.c`.

```
insert(IDE_Obj, 'ccstut.c', 68)
```

Line 68 is

```
printf("Embedded Coder: Tutorial - Memory Modified by Matlab!\n");
```

For information about adding breakpoints to a file, refer to `insert` in the online Help system. Then proceed with the tutorial.

- 2** To see the new functions, try the following functions.

```
halt(IDE_Obj)           % Halt the processor.
restart(IDE_Obj)        % Reset the PC to start of program.
run(IDE_Obj, 'runtohalt', 30); % Wait for program execution to stop at
                           % breakpoint (timeout = 30 seconds).
```

When you switch to viewing CCS IDE, you see that your program stopped at the breakpoint you inserted, and the program printed the following messages in the CCS IDE **Stdout** tab. Nothing prints in the MATLAB command window:

```
Embedded Coder: Tutorial - Initialized Memory
Double Data array = 16.3 -2.13 5.1 11.8
Integer Data array = -1-508-647-7000 (call me anytime!)
```

- 3** Before you restart your program (currently stopped at line 68), change some values in memory. Perform one of the following procedures based on your processor.

C5xxx processor family — Enter the following functions to see the read and write functions.

- a** Enter

```
ddatv = read(IDE_Obj, address(IDE_Obj, 'ddat'), 'double', 4).
```

MATLAB software responds with

```
ddatv =
```

```
16.3000 -2.1300 5.1000 11.8000
```

- b** Enter `idatv = read(IDE_Obj, address(IDE_Obj, 'idat'), 'int16', 4)`.

Now MATLAB software responds

```
idatv =
```

```
-1 508 647 7000
```

If you used 8-bit integers (`int8`), the returned values would be incorrect.

```
idatv=read(IDE_Obj, address(IDE_Obj, 'idat'), 'int8', 4)
```

```
idatv =
```

```
1 0 -4 1
```

- c** You can change the values stored in `ddat` by entering

```
write(IDE_Obj, address(IDE_Obj, 'ddat'), double([pi 12.3
exp(-1)...
sin(pi/4)]))
```

The `double` argument directs MATLAB software to write the values to the processor as double-precision data.

- d** To change `idat`, enter

```
write(IDE_Obj, address(IDE_Obj, 'idat'), int32([1:4]))
```

Here you write the data to the processor as 32-bit integers (convenient for representing phone numbers, for example).

- e** Start the program running again by entering the following command:

```
run(IDE_Obj, 'runtohalt', 30);
```

The Stdout tab in CCS IDE reveals that `ddat` and `idat` contain new values. Next, read those new values back into MATLAB software.

- f** Enter `ddatv = read(IDE_Obj, address(IDE_Obj, 'ddat'), 'double', 4)`.

```
ddatv =
```

```
3.1416 12.3000 0.3679 0.7071
```

`ddatv` contains the values you wrote in step c.

- g** Verify that the change to `idatv` occurred by entering the following command at the prompt:

```
idatv = read(IDE_Obj, address(IDE_Obj, 'idat'), 'int16', 4)
```

MATLAB software returns the new values for `idatv`.

```
idatv =
```

```
1 2 3 4
```

- h** Use `restart` to reset the program counter for your program to the beginning. Enter the following command at the prompt:

```
restart(IDE_Obj);
```

C6xxx processor family — Enter the following commands to see the read and write functions.

- a** Enter `ddatv = read(IDE_Obj, address(IDE_Obj, 'ddat'), 'double', 4)`.

MATLAB software responds with

```
ddatv =
```

```
16.3000   -2.1300    5.1000   11.8000
```

- b** Enter `idatv = read(IDE_Obj,address(IDE_Obj,'idat'),'int16',4)`.

MATLAB software responds

```
idatv =
```

```
-1 508 647 7000
```

If you used 8-bit integers (`int8`), the returned values would be incorrect.

```
idatv=read(IDE_Obj,address(IDE_Obj,'idat'),'int8',4)
```

```
idatv =
```

```
1 0 -4 1
```

- c** Change the values stored in `ddat` by entering
`write(IDE_Obj,address(IDE_Obj,'ddat'),double([pi 12.3
exp(-1)...
sin(pi/4)]))`

The `double` argument directs MATLAB software to write the values to the processor as double-precision data.

- d** To change `idat`, enter the following command:

```
write(IDE_Obj,address(IDE_Obj,'idat'),int32([1:4]))
```

In this command, you write the data to the processor as 32-bit integers (convenient for representing phone numbers, for example).

- e** Next, start the program running again by entering the following command:

```
run(IDE_Obj,'runtohalt',30);
```

The **Stdout** tab in CCS IDE reveals that `ddat` and `idat` contain new values. Read those new values back into MATLAB software.

- f** Enter `ddatv = read(IDE_Obj,address(IDE_Obj,'ddat'),'double',4)`.

```
ddatv =
3.1416 12.3000 0.3679 0.7071
```

Verify that `ddatv` contains the values you wrote in step c.

- g** Verify that the change to `idatv` occurred by entering the following command:

```
idatv = read(IDE_Obj, address(IDE_Obj, 'idat'), 'int32', 4)
```

MATLAB software returns the new values for `idatv`.

```
idatv =
1 2 3 4
```

- h** Use `restart` to reset the program counter for your program to the beginning. Enter the following command at the prompt:

```
restart(IDE_Obj);
```

- 4** Embedded Coder offers more functions for reading and writing data to your processor. These functions let you read and write data to the processor registers: `regread` and `regwrite`. They let you change variable values on the processor in real time. The functions behave slightly differently depending on your processor. Select one of the following procedures to see `regread` and `regwrite` used with your processor.

C5xxx processor family — Most registers are memory-mapped and available using `read` and `write`. However, the PC register is not memory mapped. To access this register, use the special functions — `regread` and `regwrite`. The following commands show how to use these functions to read and write to the PC register.

- a** To read the value stored in register PC, enter the following command at the prompt to indicate to MATLAB software the data type to read. The input string `binary` indicates that the PC register contains a value stored as an unsigned binary integer.

```
IDE_Obj.regread('PC', 'binary')
```

MATLAB software displays

```
ans =
```

```
33824
```

- b** To write a new value to the PC register, enter the following command. This time, the `binary` input argument tells MATLAB software to write the value to the processor as an unsigned binary integer. Notice that you used `hex2dec` to convert the hexadecimal string to decimal.

```
IDE_Obj.regwrite('PC',hex2dec('100'),'binary')
```

- c** Verify that the PC register contains the value you wrote.

```
IDE_Obj.regread('PC','binary')
```

C6xxx processor family — `regread` and `regwrite` let you access the processor registers directly. Enter the following commands to get data into and out of the A0 and B2 registers on your processor.

- a** To retrieve the value in register A0 and store it in a variable in your MATLAB workspace. Enter the following command:

```
treg = IDE_Obj.regread('A0','2scomp');
```

`treg` contains the two's complement representation of the value in A0.

- b** To retrieve the value in register B2 as an unsigned binary integer, enter the following command:

```
IDE_Obj.regread('B2','binary');
```

- c** Next, enter the following command to use `regwrite` to put the value in `treg` into register A2.

```
IDE_Obj.regwrite('A2',treg,'2scomp');
```

CCS IDE reports that A0, B2, and A2 have the values you expect. Select **View > CPU Registers > Core Registers** from the CCS IDE menu bar to list the processor registers.

Closing the Links or Cleaning Up CCS IDE

Objects that you create in Embedded Coder software have COM handles to CCS. Until you delete these handles, the CCS process (`cc_app.exe` in the

Microsoft Windows Task Manager) remains in memory. Closing MATLAB software removes these COM handles, but there may be times when you want to delete the handles without closing the application.

Use `clear` to remove objects from your MATLAB workspace and to delete handles they contain. `clear all` deletes everything in your workspace. To retain your MATLAB software data while deleting objects and handles, use `clear objname`. This applies to IDE link handle objects you created with `ticcs`. To remove the objects created during the tutorial, the tutorial program executes the following command at the prompt:

```
clear cvar cfield uintcvar
```

This tutorial also closes the project in CCS with the following command:

```
close(IDE_Obj,projfile,'project')
```

To delete your link to CCS, enter `clear IDE_Obj` at the prompt.

Your development tutorial using Code Composer Studio IDE is done.

During the tutorial you

- 1** Selected your processor.
- 2** Created and queried links to CCS IDE to get information about the link and the processor.
- 3** Used MATLAB software to load files into CCS IDE, and used MATLAB software to run that file.
- 4** Worked with your CCS IDE project from MATLAB software by reading and writing data to your processor, and changing the data from MATLAB software.
- 5** Created and used the embedded objects to manipulate data in a C-like way.
- 6** Closed the links you opened to CCS IDE.

Getting Started with RTDX

- “Using RTDX” on page 42-28
- “Creating the ticcs Objects” on page 42-33
- “Configuring Communications Channels” on page 42-35
- “Running the Application” on page 42-37
- “Closing the Connections and Channels or Cleaning Up” on page 42-44
- “Listing Functions” on page 42-47

Texas Instruments Real-Time Data Exchange (RTDX) provides “real-time, continuous visibility into the way target applications operate in the real world. RTDX allows system developers to transfer data between target devices and a host without interfering with the target application.”

You can use RTDX with Embedded Coder software and Code Composer Studio to accelerate development and deployment to Texas Instruments C2000 processors. RTDX helps you test and analyze your processing algorithms in your MATLAB workspace. RTDX lets you interact with your process in real time while it’s running on the processor. For example, you can:

- Send and retrieve data from memory on the processor
- Change the operating characteristics of the program
- Make changes to algorithms as required without stopping the program or setting breakpoints in the code

Enabling real-time interaction lets you more easily see your process or algorithm in action, the results as they develop, and the way the process runs.

This tutorial assumes you have Texas Instruments Code Composer Studio software and at least one target development board. You can use the hardware simulator in CCS IDE to run this tutorial.

After you complete the tutorial, you can start using RTDX with your applications and hardware.

Note To use RTDX with the XDS100 USB JTAG Emulator and the C28027 chip, add the following line to the linker command file:

```
_RTDX_interrupt_mask = -0x00000008;
```

Using RTDX

Digital signal processing development efforts begin with an idea for processing data; an application area, such as audio or wireless communications or multimedia computing; and a platform or hardware to host the signal processing. Usually these processing efforts involve applying strategies like signal filtering, compression, and transformation to change data content; or isolate features in data; or transfer data from one form to another or one place to another.

Developers create algorithms they need to accomplish the desired result. After they have the algorithms, they use models and target hardware development tools to test their algorithms, to determine whether the processing achieves the goal, and whether the processing works on the proposed platform.

Embedded Coder and the links for RTDX and CCS IDE ease the job of taking algorithms from the model realm to the real world of the processor on which the algorithm runs.

RTDX and links for CCS IDE provide a communications pathway to manipulate data and processing programs on your processor. RTDX offers real-time data exchange in two directions between MATLAB software and your processor process. Data you send to the processor do little to alter running processes. Plotting data you retrieve from the processor lets you see how your algorithms are performing in real time.

To introduce the techniques and tools available in Embedded Coder for using RTDX, the following procedures use many of the methods in the link software to configure the processor, open and enable channels, send data to the processor, and clean up after you finish your testing. Among the functions covered are:

Functions From Objects for CCS IDE.

Function	Description
ticcs	Create connections to CCS IDE and RTDX.
cd	Change the CCS IDE working folder from MATLAB software.
open	Load program files in CCS IDE.
run	Run processes on the processor.

Functions From the RTDX Class.

Function	Description
close	Close the RTDX links between MATLAB software and your processor.
configure	Determine how many channel buffers to use and set the size of each buffer.
disable	Disable the RTDX links before you close them.
display	Return the properties of an object in formatted layout. When you omit the closing semicolon on a function, disp (a built-in function) provides the default display for the results of the operation.
enable	Enable open channels so you can use them to send and retrieve data from your processor.
isEnabled	Determine whether channels are enabled for RTDX communications.

Function	Description
isreadable	Determine whether MATLAB software can read the specified memory location.
iswritable	Determine whether MATLAB software can write to the processor.
msgcount	Determine how many messages are waiting in a channel queue.
open	Open channels in RTDX.
readmat	Read data matrices from the processor into MATLAB software as an array.
readmsg	Read one or more messages from a channel.
writemsg	Write messages to the processor over a channel.

This tutorial provides the following workflow to show you how to use many of the functions in the links. By performing the steps provided, you work through many of the operations yourself. The tutorial follows the general task flow for developing digital signal processing programs through testing with the links for RTDX.

Within this set of tasks, numbers 1, 2, and 4 are fundamental to function syntax that interacts development projects. Whenever you work with MATLAB software and objects for RTDX, you perform the functions and tasks outlined and presented in this tutorial. The differences lie in Task 3. Task 3 is the most important for using Embedded Coder to develop your processing system.

- 1** Create an RTDX link to your desired processor and load the program to the processor.

The projects begin this way. Without the links you cannot load your executable to the processor.

2 Configure channels to communicate with the processor.

Creating the links in Task 1 did not open communications to the processor. With the links in place, you open as many channels as you need to support the data transfer for your development work. This task includes configuring channel buffers to hold data when the data rate from the processor exceeds the rate at which MATLAB software can capture the data.

3 Run your application on the processor. You use MATLAB software to investigate the results of your running process.**4** Close the links to the processor and clean up the links and associated debris left over from your work.

Closing channels and cleaning up the memory and links you created prepares CCS IDE, RTDX, and Embedded Coder for the next time you start development on a project.

This tutorial uses an executable program named `rtdxtutorial_6xevm.out` as your application. When you use the RTDX links and CCS IDE to develop your own applications, replace `rtdxtutorial_6xevm.out` in Task 3 with the filename and path to your digital signal processing application.

You can view the tutorial file used here by clicking `rtdxtutorial`. To run this tutorial in MATLAB software, click `run rtdxtutorial`.

Note To be able to open and enable channels over a link to RTDX, the program loaded on your processor must include functions or code that define the channels.

Your C source code might look something like this to create two channels, one to write and one to read.

```
rtdx_CreateInputChannel(ichan); % processor reads from this.  
rtdx_CreateOutputChannel(ochan); % processor writes to this.
```

These are the entries we use in `int16.c` (the source code that generates `rtdxtutorial_6xevm.out`) to create the read and write channels.

If you are working with a model in Simulink software and using code generation, use the To Rtdx and From Rtdx blocks in your model to add the RTDX communications channels to your model and to the executable code on your processor.

One more note about this tutorial. Throughout the code we use both the dot notation (direct property referencing) to access functions and link properties and the function form.

For example, use the following command to open and configure `ichan` for write mode.

```
IDE_Obj.rtdx.open('ichan','w');
```

You could use an equivalent syntax, the function form, that does not use direct property referencing.

```
open(IDE_Obj.rtdx,'ichan','w');
```

Or, use

```
open(rx,'ichan','w');
```

if you created an alias `rx` to the RTDX portion of `IDE_Obj`, as shown by the following command:

```
rx = IDE_Obj.rtdx;
```

Creating the ticcs Objects

With your processing model converted to an executable for your desired processor, you are ready to use the objects to test and run your model on your processor. Embedded Coder and the objects do not distinguish the source of the executable — whether you used Embedded Coder, CCS IDE, or some other development tool to program and compile your model to an executable does not alter the object connections. So long as your .out file is acceptable to the processor you select, Embedded Coder provides the connection to the processor.

Before continuing with this tutorial, you must load a valid GEL file to configure the EMIF registers of your processor and perform required processor initialization steps. Default GEL files provided by CCS are stored in `.. \IDE_Obj \gel` in the folder where you installed CCS software. Select **File > Load_GEL** in CCS IDE to load the default GEL file that matches your processor family, such as `init6x0x.gel` for the Cxxxx processor family, and your configuration.

Note If you are performing the steps in this tutorial, create `demoPjt` as described in “Loading Files into CCS” on page 42-17 before continuing.

Begin the process of getting your model onto the processor by creating an object that refers to CCS IDE. Start by clearing function syntax that interacts existing handles and setting echo on so you see functions execute as the program runs:

```
1 clear all; echo on;
```

`clear all` removes debugging breakpoints and resets persistent variables because function breakpoints and persistent variables are cleared whenever the MATLAB file changes or is cleared. Breakpoints within your executable remain after `clear`. Clearing the MATLAB workspace does not alter your executable.

2 Now construct the link to your board and processor by entering

```
IDE_Obj=ticcs('boardnum',0);
```

`boardnum` defines which board the new link accesses. In this example, `boardnum` is 0. Embedded Coder connects the link to the first, and in this case only, processor on the board. To find the `boardnum` and `procnum` values for the boards and simulators on your system, use `ccsboardinfo`. When you enter the following command at the prompt

```
ccsboardinfo
```

- 3** To open and load the processor file, change the path for MATLAB software to be able to find the file.

```
projname = C:\Temp\EmbIDELinkCCDemos_v4.1\rtdx tutorial\cxx\cxxxp\rtdx tut_sim.pjt
```

```
outFile = C:\Temp\EmbIDELinkCCDemos_v4.1\rtdx tutorial\cxx\cxxxp\rtdx tut_sim.out
```

```
processor_dir = demoPjt.DemoDir
```

```
processor_dir = C:\Temp\EmbIDELinkCCDemos_v4.1\rtdx tutorial\cxx\cxxxp
```

```
cd(IDE_Obj,processor_dir); % Go to processor directory
```

```
cd(IDE_Obj,tgt_dir); % Or IDE_Obj.cd(tgt_dir)
```

```
dir(IDE_Obj); % Or IDE_Obj.dir
```

To load the project file to your processor, enter the following commands at the MATLAB software prompt. `getDemoProject` is a specialized function for loading Embedded Coder example files. It is not supported as a standard Embedded Coder function.

```
demoPjt = getDemoProject(IDE_Obj,'ccstutorial');
```

```
demoPjt.ProjectFile
```

```
ans = C:\Temp\EmbIDELinkCCDemos_v4.1\ccstutorial\cxx\cxxxp\ccstut.pjt
```

```
demoPjt.DemoDir
```

```
ans = C:\Temp\EmbIDELinkCCDemos_v4.1\ccstutorial\cxx\cxxxp
```

Notice where the example files are stored on your machine. In general, Embedded Coder software stores the example project files in

```
EmbIDELinkCCDemos_v#. #
```

For example, if you are using version 4.1 of Embedded Coder software, the project examples are stored in `EmbIDELinkCCDemos_v4.1\`. Embedded Coder software creates this folder in a location on your machine where you have write permission. Usually, there are two locations where Embedded Coder software tries to create the example folder, in the order shown.

- a** In a temporary folder on the C drive, such as `C:\temp\`.
 - b** If Embedded Coder software cannot use the `temp` folder, you see a dialog that asks you to select a location to store the examples.
- 4** You have reset the folder path to find the tutorial file. Now open the `.out` file that matches your processor type.

```
IDE_Obj.open('rtdxtutorial_xxx.out')
```

Because `open` is overloaded for the CCS IDE and RTDX links, this may seem a bit strange. In this syntax, `open` loads your executable file onto the processor identified by `IDE_Obj`. Later in this tutorial, you use `open` with a different syntax to open channels in RTDX.

In the next section, you use the new link to open and enable communications between MATLAB software and your processor.

Configuring Communications Channels

Communications channels to the processor do not exist until you open and enable them through Embedded Coder and CCS IDE. Opening channels consists of opening and configuring each channel for reading or writing, and enabling the channels.

In the `open` function, you provide the channel names as strings for the channel name property. The channel name you use is not random. The channel name string must match a channel defined in the executable file. If you specify a string that does not identify an existing channel in the executable, the open operation fails.

In this tutorial, two channels exist on the processor — `ichan` and `ochan`. Although the channels are named `ichan` for input channel and `ochan` for output channel, neither channel is configured for input or output until you configure them from MATLAB software or CCS IDE. You could configure `ichan` as the output channel and `ochan` as the input channel. The links would work just the same. For simplicity, the tutorial configures `ichan` for input and `ochan` for output. One more note—reading and writing are defined as seen by the processor. When you write data from MATLAB software, you write to the channel that the processor reads, `ichan` in this case. Conversely, when you read from the processor, you read from `ochan`, the channel that the processor writes to:

- 1** Configure buffers in RTDX to store the data until MATLAB software can read it into your workspace. Often, MATLAB software cannot read data as quickly as the processor can write it to the channel.

```
IDE_Obj.rtdx.configure(1024,4); % define 4 channels of 1024 bytes each
```

Channel buffers are optional. Adding them provides a measure of insurance that data gets from your processor to MATLAB software without getting lost.

- 2** Define one of the channels as a write channel. Use `'ichan'` for the channel name and `'w'` for the mode. Either `'w'` or `'r'` fits here, for write or read.

```
IDE_Obj.rtdx.open('ichan','w');
```

- 3** Now enable the channel you opened.

```
IDE_Obj.rtdx.enable('ichan');
```

- 4** Repeat steps 2 and 3 to prepare a read channel.

```
IDE_Obj.rtdx.open('ochan','r');  
IDE_Obj.rtdx.enable('ochan');
```

- 5** To use the new channels, enable RTDX by entering

```
IDE_Obj.rtdx.enable;
```

You could do this step before you configure the channels — the order does not matter.

- 6 Reset the global time-out to 20s to provide a little room for error. `ticcs` applies a default timeout value of 10 s. In some cases this may not be enough.

```
IDE_Obj.rtdx.get('timeout')
ans =
    10
IDE_Obj.rtdx.set('timeout', 20); % Reset timeout = 20 seconds
```

- 7 Check that the `timeout` property value is now 20s and that your object has a valid configuration for the rest of the tutorial.

```
IDE_Obj.rtdx

RTDX Object:
  API version:      1.0
  Default timeout:  20.00 secs
  Open channels:    2
```

Running the Application

To this point you have been doing common housekeeping functions. You load the processor, configure the communications, and set up other properties you need.

This tutorial shows you some of the Embedded Coder functions you can use to prototype and experiment with your application. To see the `RTDX readmat`, `readmsg`, and `writemsg` functions, you write data to your processor. Then, after the data has been processed, you read data from the processor.

- 1 Restart the program you loaded on the processor. `restart` sets the program counter (PC) to the beginning of the executable code on the processor.

```
IDE_Obj.restart
```

Restarting the processor does not start the program executing. You use `run` to start program execution.

- 2 Type `IDE_Obj.run('run');`

Using 'run' for the run mode tells the processor to continue to execute the loaded program continuously until it receives a halt directive. In this mode, control returns to MATLAB software so you can work in MATLAB software while the program runs. Other options for the mode are

- 'runtohalt' — start to execute the program and wait to return control to MATLAB software until the process reaches a breakpoint or execution terminates.
- 'tohalt' — change the state of a running processor to 'runtohalt' and wait to return until the program halts. Use tohalt mode to stop the running processor cleanly.

- 3** Type the following functions to enable the write channel and verify the change:

```
IDE_Obj.rtdx.enable('ichan');  
IDE_Obj.rtdx.isenabled('ichan')
```

If MATLAB software responds `ans = 0` your channel is not enabled and you cannot proceed with the tutorial. Try to enable the channel again and verify the status.

- 4** Write some data to the processor. Check that you can write to the processor, then use `writemsg` to send the data. You do not need to enter the if-test code shown.

```
if IDE_Obj.rtdx.iswritable('ichan'), % Used in a script application.  
    disp('writing to processor...') % Optional to display progress.  
    indata=1:10  
    IDE_Obj.rtdx.writemsg('ichan', int16(indata))  
end % Used in scripts for channel testing.
```

The if statement simulates writing the data from within a MATLAB software script. The script uses `iswritable` to check that the input channel is functioning. If `iswritable` returns 0 the script would skip the write and exit the program, or respond in some way. When you are writing or reading data to your processor in a script or MATLAB file, checking the status of the channels can help you avoid errors during execution.

As your application runs you may find it helpful to display progress messages. In this case, the program directed MATLAB software to print a message as it reads the data from the processor by adding the function

```
disp('writing to processor...')
```

Function `IDE_Obj.rtdx.writemsg('ichan', int16(indata))` results in 20 messages stored on the processor. Here's how.

When you write `indata` to the processor, the following code running on the processor takes your input data from `ichan`, adds one to the values and copies the data to memory:

```
while ( !RTDX_isInputEnabled(&ichan) )

/* wait for channel enable from MATLAB */
RTDX_read( &ichan, recvd, sizeof(recvd) );
puts("\n\n Read Completed ");

for (j=1; j<=20; j++) {
    for (i=0; i<MAX; i++) {
        recvd[i] +=1;
    }
    while ( !RTDX_isOutputEnabled(&ochan) )
        { /* wait for channel enable from MATLAB */ }
    RTDX_write( &ochan, recvd, sizeof(recvd) );
    while ( RTDX_writing != NULL )
        { /* wait for data xfer INTERRUPT DRIVEN for Cxxxx */ }
}
```

Program `int16_rtdx.c` contains this source code. You can find the file in a folder in the `..\tidemos\rtdxtutorial` folder.

- 5 Type the following to check the number of available messages to read from the processor.

```
num_of_msgs = IDE_Obj.rtdx.msgcount('ochan');
```

`num_of_msgs` should be zero. Using this process to check the amount of data lets you or your program know how much data to expect.

- 6** Type the following to verify that your read channel `ochan` is enabled for communications.

```
IDE_Obj.rtdx.isenabled('ochan')
```

You should get back `ans = 0` — you have not enabled the channel yet.

- 7** Now enable and verify 'ochan'.

```
IDE_Obj.rtdx.enable('ochan');  
IDE_Obj.rtdx.isenabled('ochan')
```

To show that `ochan` is ready, MATLAB software responds `ans = 1`. If not, try enabling `ochan` again.

- 8** Type

```
pause(5);
```

The `pause` function gives the processor extra time to process the data in `indata` and transfer the data to the buffer you configured for `ochan`.

- 9** Repeat the check for the number of messages in the queue. There should be 20 messages available in the buffer.

```
num_of_msgs = IDE_Obj.rtdx.msgcount('ochan')
```

With `num_of_msgs = 20`, you could use a looping structure to read the messages from the queue in to MATLAB software. In the next few steps of this tutorial you read data from the `ochan` queue to different data formats within MATLAB software.

- 10** Read one message from the queue into variable `outdata`.

```
outdata = IDE_Obj.rtdx.readmsg('ochan','int16')
```

```
outdata =  
     2     3     4     5     6     7     8     9    10    11
```

Notice the 'int16' represent option. When you read data from your processor you need to tell MATLAB software the data type you are reading.

You wrote the data in step 4 as 16-bit integers so you use the same data type here.

While performing reads and writes, your process continues to run. You did not need to stop the processor to get the data or send the data, unlike using most debuggers and breakpoints in your code. You placed your data in memory across an RTDX channel, the processor used the data, and you read the data from memory across an RTDX channel, without stopping the processor.

- 11** You can read data into cell arrays, rather than into simple double-precision variables. Use the following function to read three messages to cell array `outdata`, an array of three, 1-by-10 vectors. Each message is a 1-by-10 vector stored on the processor.

```
outdata = IDE_Obj.rtdx.readmsg('ochan','int16',3)

outdata =
 [1x10 int16] [1x10 int16] [1x10 int16]
```

- 12** Cell array `outdata` contains three messages. Look at the second message, or matrix, in `outdata` by using dereferencing with the array.

```
outdata{1,2}

outdata =
     4     5     6     7     8     9    10    11    12    13
```

- 13** Read two messages from the processor into two 2-by-5 matrices in your MATLAB workspace.

```
outdata = IDE_Obj.rtdx.readmsg('ochan','int16',[2 5],2)

outdata =
 [2x5 int16] [2x5 int16]
```

To specify the number of messages to read and the data format in your workspace, you used the `siz` and `nummsgs` options set to `[2 5]` and `2`.

- 14** You can look at both matrices in `outdata` by dereferencing the cell array again.

```
outdata{1,:}

ans =
     6     8    10    12    14
     7     9    11    13    15
ans =
     7     9    11    13    15
     8    10    12    14    16
```

- 15** For a change, read a message from the queue into a column vector.

```
outdata = IDE_Obj.rtdx.readmsg('ochan','int16',[10 1])

outdata =
     8
     9
    10
    11
    12
    13
    14
    15
    16
    17
```

- 16** Embedded Coder provides a function for reading messages into matrices—`readmat`. Use `readmat` to read a message into a 5-by-2 matrix in MATLAB software.

```
outdata = readmat(IDE_Obj.rtdx,'ochan','int16',[5 2])

outdata =
     9    14
    10    15
    11    16
    12    17
    13    18
```

Because a 5-by-2 matrix requires ten elements, MATLAB software reads one message into `outdata` to fill the matrix.

- 17** To check your progress, see how many messages remain in the queue. You have read eight messages from the queue so 12 should remain.

```
num_of_msgs = IDE_Obj.rtdx.msgcount('ochan')

num_of_msgs =
    12
```

- 18** To see the connection between messages and a matrix in MATLAB software, read data from 'ochan' to fill a 4-by-5 matrix in your workspace.

```
outdata = IDE_Obj.rtdx.readmat('ochan','int16',[4 5])

outdata =
    10  14  18  13  17
    11  15  19  14  18
    12  16  11  15  19
    13  17  12  16  20
```

Filling the matrix required two messages worth of data.

- 19** To verify that the last step used two messages, recheck the message count. You should find 10 messages waiting in the queue.

```
num_of_msgs = IDE_Obj.rtdx.msgcount('ochan')
```

- 20** Continuing with matrix reads, fill a 10-by-5 matrix (50 matrix elements or five messages).

```
outdata = IDE_Obj.rtdx.readmat('ochan','int16',[10 5])

outdata =
    12  13  14  15  16
    13  14  15  16  17
    14  15  16  17  18
    15  16  14  18  19
    16  17  18  19  20
    17  18  19  20  21
    18  19  20  21  22
    19  20  21  22  23
    20  21  22  23  24
```

21 22 23 24 25

21 Recheck the number of messages in the queue to see that five remain.

22 `flush` lets you remove messages from the queue without reading them. Data in the message you remove is lost. Use `flush` to remove the next message in the read queue. Then check the waiting message count.

```
IDE_Obj.rtdx.flush('ochan',1)
num_of_msgs = IDE_Obj.rtdx.msgcount('ochan')
```

```
num_of_msgs =
```

```
4
```

23 Empty the remaining messages from the queue and verify that the queue is empty.

```
IDE_Obj.rtdx.flush('ochan', 'all')
```

With the `all` option, `flush` discards the messages in the `ochan` queue.

Closing the Connections and Channels or Cleaning Up

One of the most important programmatic processes you should do in every RTDX session is to clean up at the end. Cleaning up includes stopping your processor, disabling the RTDX channels you enabled, disabling RTDX and closing your open channels. Performing this series of tasks prevents trouble caused by unexpected interactions with remaining handles, channels, and links from earlier development work.

Best practices suggest that you include the following tasks (or an subset that meets your development needs) in your development scripts and programs.

We use several functions in this section; each has a purpose — the operational details in the following list explain how and why we use each one. They are

- `close` — close the specified RTDX channel. To use the channel again, you must open and enable the channel. Compare `close` to `disable`. `close('rtdx')` closes the communications provided by RTDX. After you close RTDX, you cannot communicate with your processor.

- `disable` — remove RTDX communications from the specified channel, but does not remove the channel, or link. Disabling channels may be useful when you do not want to see the data that is being fed to the channel, but you may want to read the channel later. By enabling the channel later, you have access to the data entering the channel buffer. Note that data that entered the channel while it was disabled is lost.
- `halt` — stop a running processor. You may still have one or more messages in the host buffer.

Use the following procedure to shut down communications between MATLAB software and the processor, and end your session:

- 1 Begin the process of shutting down the processor and RTDX by stopping the processor. Type the following functions at the prompt.

```
if (isrunning(IDE_Obj)) % Use this test in scripts.  
    IDE_Obj.halt;      % Halt the processor.  
end                   % Done.
```

Your processor may already be stopped at this point. In a script, you might put the function in an `if`-statement as we have done here. When you direct a stopped processor to `halt`, the function returns immediately.

- 2 You have stopped the processor. Now disable the RTDX channels you opened to communicate with the processor.

```
IDE_Obj.rtdx.disable('all');
```

If required, using `disable` with channel name and processor identifier input arguments lets you disable only the channel you choose. When you have more than one board or processor, you may find disabling selected channels meets your needs.

When you finish your RTDX communications session, disable RTDX so that Embedded Coder releases your open channels before you close them.

```
IDE_Obj.rtdx.disable;
```

3 Use the following function syntaxes to close your open channels. Either close selected channels by using the channel name in the function, or use the `all` option to close the open channels.

- `IDE_Obj.rtdx.close('ichan')` to close your input channel in this tutorial.
- `IDE_Obj.rtdx.close('ochan')` to close your output channel in the tutorial.
- `IDE_Obj.rtdx.close('all')` to close your open RTDX channels, regardless of whether they are part of this tutorial.

Consider using the `all` option with the `close` function when you finish your RTDX work. Closing channels reduces unforeseen problems caused by channel objects that exist but do not get closed when you end your session.

4 When you created your RTDX object (`IDE_Obj = ticcs('boardnum',1)`) at the beginning of this tutorial, the `ticcs` function opened CCS IDE and set the visibility to 0. To avoid problems that occur when you close the interface to RTDX with CCS visibility set to 0, make CCS IDE visible on your desktop. The following `if` statement checks the CCS IDE visibility and changes it if required.

```
if IDE_Obj.isvisible,  
    IDE_Obj.visible(1);  
end
```

Visibility can cause problems. When CCS IDE is running invisibly on your desktop, do not use `clear all` to remove your links for CCS IDE and RTDX. Without a `ticcs` object that references the CCS IDE you cannot access CCS IDE to change the visibility setting, or close the application. To close CCS IDE when you do not have an existing object, either create a new object to access the CCS IDE, or use Microsoft Windows Task Manager to end the process `cc_app.exe`, or close the MATLAB software.

5 You have finished the work in this tutorial. Enter the following commands to close your remaining references to CCS IDE and release the associated resources.

```
clear ('all'); % Calls the link destructors to remove all links.  
echo off
```

`clear all` without the parentheses removes the variables from your MATLAB workspace.

You have completed the tutorial using RTDX. During the tutorial you

- 1** Opened connections to CCS IDE and RTDX and used those connections to load an executable program to your processor.
- 2** Configured a pair of channels so you could transfer data to and from your processor.
- 3** Ran the executable on the processor, sending data to the processor for processing and retrieving the results.
- 4** Stopped the executing program and closed the links to CCS IDE and RTDX.

This tutorial provides a working process for using Embedded Coder and your signal processing programs to develop programs for a range of Texas Instruments processors. While the processor may change, the essentials of the process remain the same.

Listing Functions

To review a complete list of functions and methods that operate with `ticcs` objects, either CCS IDE or RTDX, enter either of the following commands at the prompt.

```
help ticcs  
help rtdx
```

If you already have a `ticcs` object `IDE_Obj`, you can use dot notation to return the methods for CCS IDE or RTDX by entering one of the following commands at the prompt:

- `IDE_Obj.methods`
- `IDE_Obj.rtdx.methods`

In either instance MATLAB software returns a list of the available functions for the specified link type, including both public and private functions. For example, to see the functions (methods) for links to CCS IDE, enter:

```
help ticcs
```

Constructing ticcs Objects

When you create a connection to CCS IDE using the `ticcs` command, you are creating a “`ticcs` object for accessing the CCS IDE and RTDX interface”. The `ticcs` object implementation relies on MATLAB software object-oriented programming capabilities.

The discussions in this section apply to the `ticcs` objects in Embedded Coder.

Like other MATLAB software structures, objects in Embedded Coder have predefined fields called object properties.

You specify object property values by one of the following methods:

- Setting the property values when you create the `ticcs` object
- Creating an object with default property values, and changing these property values later

For examples of setting `ticcs` object properties, refer to `ticcs`.

Constructor for ticcs Objects

The easiest way to create an object is to use the function `ticcs` to create an object with the default properties. Create an object named `IDE_Obj` to refer to CCS IDE by entering

```
IDE_Obj = ticcs
```

MATLAB software responds with a list of the properties of the object `IDE_Obj` you created along with the associated default property values.

```
ticcs object:
  API version      : 1.0
  Processor type   : Cxx
  Processor name   : CPU
```



```
Running?           : No
Board number      : 0
Processor number  : 0
Default timeout   : 10.00 secs

RTDX channels     : 0
```

Inspecting the output reveals two objects listed—a CCS IDE object and an RTDX object. CCS IDE and RTDX objects cannot be created separately. By design they maintain a member class relationship; the RTDX object is a class, a member of the CCS object class. In this example, `IDE_Obj` is an instance of the class `CCS`. If you enter

```
rx = IDE_Obj.rtdx
```

`rx` is a handle to the RTDX portion of the CCS object. As an alias, `rx` replaces `IDE_Obj.rtdx` in functions such as `readmat` or `writemsg` that use the RTDX communications features of the CCS link. Typing `rx` at the command line now produces

```
rx
```

```
RTDX channels     : 0
```

The object properties are described in the function reference, and in more detail in `tics` Object Properties. These properties are set to default values when you construct objects.

tics Properties and Property Values

Objects in Embedded Coder software have properties associated with them. Each property is assigned a value. You can set the values of most properties, either when you create the link or by changing the property value later. However, some properties have read-only values. And a few property values, such as the board number and the processor to which the link attaches, become read-only after you create the object. You cannot change those after you create your link.

Overloaded Functions for ticcs Objects

Several functions in this Embedded Coder have the same name as functions in other MathWorks toolboxes or in MATLAB software. These behave similarly to their original counterparts, but you apply these functions directly to an object. This concept of having functions with the same name operate on different types of objects (or on data) is called *overloading* of functions.

For example, the `set` command is overloaded for `ticcs` objects. After you specify your link by assigning values to its properties, you can apply the functions in this toolbox (such as `readmat` for using RTDX to read an array of data from the processor) directly to the variable name you assign to your object, without specifying your object parameters again.

ticcs Object Properties

- “Quick Reference to ticcs Object Properties” on page 42-51
- “Details About ticcs Object Properties” on page 42-52

Embedded Coder provides an interface to your processor hardware so you can communicate with processors for which you are developing systems and algorithms. Each `ticcs` object comprises two objects—a CCS IDE object and an RTDX interface object. The objects are not separable; the RTDX object is a subclass of the CCS IDE object. Each of the objects has multiple properties. To configure the interface objects for CCS IDE and RTDX, you set parameters that define details such as the desired board, the processor, the timeout period applied for communications operations, and a number of other values. Because Embedded Coder uses objects to create the interface, the parameters you set are called properties and you treat them as properties when you set them, retrieve them, or modify them.

This section details the properties for the `ticcs` objects for CCS IDE and RTDX. First the section provides tables of the properties, for quick reference. Following the tables, the section offers in-depth descriptions of each property, its name and use, and whether you can set and get the property value associated with the property. Descriptions include a few examples of the property in use.

MATLAB software users may find much of this handling of objects familiar. Objects in Embedded Coder, behave like objects in MATLAB software and the other object-oriented toolboxes. For C++ programmers, discussion of object-oriented programming is likely to be a review.

Quick Reference to ticcs Object Properties

The following table lists the properties for the ticcs objects in Embedded Coder. The second column tells you which object the property belongs to. Knowing which property belongs to each object in a ticcs object tells you how to access the property.

Property Name	Applies to Which Connection?	User Settable?	Description
apiversion	CCS IDE	No	Reports the version number of your CCS API.
boardnum	CCS IDE	Yes/initially	Specifies the index number of a board that CCS IDE recognizes.
ccsappexe	CCS IDE	No	Specifies the path to the CCS IDE executable. Read-only property.
numchannels	RTDX	No	Contains the number of open RTDX channels for a specific link.
page	CCS IDE	Yes/default	Stores the default memory page for reads and writes.
procnum	CCS IDE	Yes/at start only	Stores the number CCS Setup Utility assigns to the processor.

Property Name	Applies to Which Connection?	User Settable?	Description
timeout	CCS IDE	Yes/default	Contains the global timeout setting for the link.
version	RTDX	No	Reports the version of your RTDX software.

Some properties are read only — you cannot set the property value. Other properties, you can change. If the entry in the User Settable column is “Yes/initially”, you can set the property value only when you create the link. Thereafter it is read only.

Details About ticcs Object Properties

To use the links for CCS IDE and RTDX interface you set values for:

- boardnum — specify the board with which the link communicates.
- procnum — specify the processor on the board. If the board has multiple processors, procnum identifies the processor to use.
- timeout — specify the global timeout value. (Optional. Default is 10 s.)

Details of the properties associated with connections to CCS IDE and RTDX interface appear in the following sections, listed in alphabetical order by property name.

Many of these properties are object linking and embedding (OLE) handles. The MATLAB software COM server creates the handles when you create objects for CCS IDE and RTDX. You can manipulate the OLE handles using `get`, `set`, and `invoke` to work directly with the COM interface with which the handles interact.

apiversion. Property `apiversion` contains a string that reports the version of the application program interface (API) for CCS IDE that you are using when you create a link. You cannot change this string. When you upgrade the API, or CCS IDE, the string changes to match. Use `display` to see the `apiversion` property value for a link. This example shows the `apiversion` value for link `IDE_Obj`.

```
display(IDE_Obj)
```

```
TICCS Object:
```

```
API version      : 1.0
Processor type   : Cxx
Processor name   : CPU
Running?        : No
Board number     : 0
Processor number : 0
Default timeout  : 10.00 secs

RTDX channels    : 0
```

Note that the API version is not the same as the CCS IDE version.

boardnum. Property `boardnum` identifies the board referenced by the IDE link handle object for CCS. When you create a link, you use `boardnum` to specify the board you are using. To get the value for `boardnum`, use `ccsboardinfo` or the CCS Setup utility from Texas Instruments software. The CCS Setup utility assigns the number for each board installed on your system.

ccsappexe. Property `ccsappexe` contains the path to the CCS IDE executable file `cc_app.exe`. When you use `ticcs` to create a link, MATLAB software determines the path to the CCS IDE executable and stores the path in this property. This is a read-only property. You cannot set it.

numchannels. Property `numchannels` reports the number of open RTDX communications channels for an RTDX link. Each time you open a channel for a link, `numchannels` increments by one. For new links `numchannels` is zero until you open a channel for the link.

To see the value for `numchannels` create a link to CCS IDE. Then open a channel to RTDX. Use `display` to see the RTDX link properties.

```
IDE_Obj=ticcs

TICCS Object:
  API version      : 1.0
  Processor type   : Cxx
  Processor name   : CPU
  Running?        : No
  Board number     : 0
  Processor number : 0
  Default timeout  : 10.00 secs

  RTDX channels    : 0

rx=IDE_Obj.rtdx

  RTDX channels    : 0

open(rx,'ichan','r','ochan','w');

get(IDE_Obj.rtdx)

ans =

    numChannels: 2
           Rtdx: [1x1 COM ]
    RtdxChannel: {'' '' ''}
           procType: 103
           timeout: 10
```

page. Property page contains the default value CCS IDE uses when the user does not specify the page input argument in the syntax for a function that access memory.

procnum. Property procnum identifies the processor referenced by the IDE link handle object for CCS. When you create an object, you use procnum to specify the processor you are using . The CCS Setup Utility assigns a number to each processor installed on each board. To determine the value of procnum for a processor, use ccsboardinfo or the CCS Setup utility from Texas Instruments software.

To identify a processor, you need both the `boardnum` and `procnum` values. For boards with one processor, `procnum` equals zero. CCS IDE numbers the processors on multiprocessor boards sequentially from 0 to the number of processors. For example, on a board with four processors, the processors are numbered 0, 1, 2, and 3.

rtdx. Property `rtdx` is a subclass of the `ticcs` link and represents the RTDX portion of the IDE link handle object for CCS. As shown in the example, `rtdx` has properties of its own that you can set, such as `timeout`, and that report various states of the link.

```
get(IDE_Obj.rtdx)

ans =

    version: 1
 numChannels: 0
      Rtdx: [1x1 COM ]
 RtdxChannel: {'' [] ''}
   procType: 103
   timeout: 10
```

In addition, you can create an alias to the `rtdx` portion of a link, as shown in this code example.

```
rx=IDE_Obj.rtdx

RTDX channels    : 0
```

Now you can use `rx` with the functions in Embedded Coder, such as `get` or `set`. If you have two open channels, the display looks like the following example:

```
get(rx)

ans =

 numChannels: 2
      Rtdx: [1x1 COM ]
 RtdxChannel: {2x3 cell}
   procType: 98
   timeout: 10
```

rtdxchannel. Property `rtdxchannel`, along with `numchannels` and `proctype`, is a read-only property for the RTDX portion of the IDE link handle object for CCS. To see the value of this property, use `get` with the link. Neither `set` nor `invoke` work with `rtdxchannel`.

`rtdxchannel` is a cell array that contains the channel name, handle, and mode for each open channel for the link. For each open channel, `rtdxchannel` contains three fields, as follows:

<code>.rtdxchannel{i,1}</code>	Channel name of the <i>i</i> th-channel, <i>i</i> from 1 to the number of open channels
<code>.rtdxchannel{i,2}</code>	Handle for the <i>i</i> th-channel
<code>.rtdxchannel{i,3}</code>	Mode of the <i>i</i> th-channel, either 'r' for read or 'w' for write

With four open channels, `rtdxchannel` contains four channel elements and three fields for each channel element.

timeout. Property `timeout` specifies how long CCS IDE waits for a process to finish. Two `timeout` periods can exist — one global, one local. You set the global `timeout` when you create the IDE link handle object for CCS. The default global `timeout` value 10 s. However, when you use functions to read or write data to CCS IDE or your processor, you can set a local `timeout` that overrides the global value. If you do not set a specific `timeout` value in a read or write process syntax, the global `timeout` value applies to the operation. Refer to the help for the read and write functions for the syntax to set the local `timeout` value for an operation.

version. Property `version` reports the version number of your RTDX software. When you create a `ticcs` object, `version` contains a string that reports the version of the RTDX application that you are using. You cannot change this string. When you upgrade the API, or CCS IDE, the string changes to match. Use `display` to see the `version` property value for a link. This example shows the `apiversion` value for object `rx`.

```
get(rx) % rx is an alias for IDE_Obj.rtdx.
```

```
ans =
```



```
version: 1
numChannels: 0
  Rtdx: [1x1 COM ]
RtdxChannel: {'' [] ''}
procType: 103
timeout: 10
```

IDE Project Generator

In this section...

“Introducing IDE Project Generator” on page 42-58

“IDE Project Generator and Board Selection” on page 42-58

“Generate an IDE Project” on page 42-60

“Model Reference” on page 42-64

Introducing IDE Project Generator

IDE Project Generator provides the following features for developing project and generating code:

- Support automated project building for Texas Instruments Code Composer Studio software that lets you create projects from code generated by Embedded Coder products. The project automatically populates CCS projects in the CCS development environment.
- Configure code generation using model Configuration Parameters and processor preferences block options
- Select from two system target files to generate code specific to your processor
- Configure project build process
- Automatically download and run your generated projects on your processor

Note You cannot generate code for C6000 processors in big-endian mode. Code generation supports only little-endian processor data byte order.

IDE Project Generator and Board Selection

IDE Project Generator uses `ticcs` objects to connect to the IDE. Each time you build a model to generate a project, the build process starts by issuing the `ticcs` method, as shown here:

```
IDE_Obj=ticcs('boardnum',boardnum,'procnum',procnum)
```

The software attempts to connect to the board (boardnum) and processor (procnum) associated with the **Board name** and **Processor number** parameters located on the Target Hardware Resources pane in the model Configuration Parameters.

The result of the `ticcs` method changes, depending on the boards you configured in CCS. The following table describes how the software selects the board to connect to in your board configuration.

CCS Board Configuration State	Response by Software
Code Composer Studio or Embedded Coder software not installed.	Returns an error message asking you to verify that you installed both Code Composer Studio and Embedded Coder.
Code Composer Studio software does not have configured boards.	Returns an error message that the software could not find boards in your configuration. Use Setup Code Composer Studio to configure at least one board.
Code Composer Studio software has one configured board.	Attaches to the board regardless of the value of the Board parameter. You see a warning message telling you which board the software selected.
Code Composer Studio software has one board configured that does not match the value of the Board parameter. ^(*)	Returns a warning message that the software could not find the board specified in the block and connected to the board listed in the warning message. The software connects to the first board in your CCS configuration.

CCS Board Configuration State	Response by Software
Code Composer Studio has more than one board configured. The value of the Board parameter is one of the configured boards.	Connects to the specified board.
Code Composer Studio has more than one board configured. The value of the Board parameter is not one of the configured boards. ^(*)	<p>Returns a message asking you to select a board from the list of configured boards. You have two choices:</p> <ul style="list-style-type: none"> • Select a board to use for project generation, and click OK. Your selection does not change the value of the Board parameter. The software connects to the selected board. • Click Abort to stop the project build and code generation process. The software does not connect to the IDE or board.

^(*)You may encounter the situation where you do not have the valid board configured in CCS because of one of the following conditions:

- You changed your board configuration and saved the model. When you reopen the model, the board specified in **Board name** in the block is not in your configuration.
- You are working with a model from a source whose board configuration is not the same as yours.

Use `ccsboardinfo` at the MATLAB prompt to verify or review your configured boards.

Generate an IDE Project

- “Creating the Model” on page 42-61
- “Specify Configuration Parameters for Your Model” on page 42-62

In this tutorial you will use the Embedded Coder software to:

- Build a model.
- Generate a project from the model.
- Build the project and run the binary on a processor.

Note The model shows project generation. You cannot not build and run the model on your processor without additional blocks.

To generate a project from a model, complete the following tasks:

- 1** Create a model application.
- 2** Configure your model for your IDE, tool chain, and target hardware, as described in “Configure Target Hardware Resources” on page 35-3.
- 3** In the Configuration Parameters, also set:
 - Solver parameters such as simulation start and solver options
 - Software options such as processor configuration and processor compiler selection
- 4** Generate your project.
- 5** Review your project in CCS.

Creating the Model

To build a model, follow these steps:

- 1** Open the Simulink Library Browser.
- 2** Use Simulink blocks to create a model, or open one of the example models for Texas Instruments Code Composer Studio.
- 3** Name and save your model before continuing.

Specify Configuration Parameters for Your Model

The following sections describe how to configure the build and run parameters for your model. Generating a project, or building and running a model on the processor, starts with configuring model options in the Configuration Parameters dialog in Simulink software.

Setting Solver Parameters. After you have designed and implemented your digital signal processing model in Simulink software, complete the following steps to set the Configuration Parameters for the model:

- 1** Configure your model for your IDE, tool chain, and target hardware, as described in “Configure Target Hardware Resources” on page 35-3.
- 2** Select the Solver pane in the Configuration Parameters dialog.
- 3** Set **Start time** to 0.0 and **Stop time** to `inf` (model runs without stopping). If you set a stop time, your generated code does not honor the setting. Set this to `inf` for completeness.
- 4** Under **Solver options**, set **Type** to `fixed-step` and set **Solver** to `discrete` (no continuous states). For PIL, set **Type** and **Solver** to any setting.
- 5** For **Fixed step size (fundamental sample time)**, enter `Auto`, and set **Tasking mode for periodic sample times** to `SingleTasking`.

Note Generated code does not honor Simulink software stop time from the simulation. Stop time is interpreted as `inf`. To implement a stop in generated code, add a Stop Simulation block in your model.

When you use PIL, you can set the **Solver options** to any selection from the **Type** and **Solver** lists.

Ignore the **Data Import/Export**, **Diagnostics**, and **Optimization** panes in the Configuration Parameters dialog. The default settings are valid for your new model.

Setting Code Generation Parameters. To configure your software to use the right processor files and to compile and run your model executable file, configure the **Code Generation** pane in the Configuration Parameters dialog.

- 1 In the Configuration Parameters dialog, select the **Code Generation** pane.
- 2 Use the **Browse** button to set **System target file** to `idelink_grt.tlc`.

Setting Coder Target Parameters. To configure code generation options and to compile and run your model executable file, configure the Coder Target pane in the Configuration Parameters dialog.

- 1 In the Configuration Parameters dialog, expand the node for the **Code Generation** pane and select the **Coder Target** pane.
- 2 Set the following options in the pane under **Vendor Tool Chain**:
 - **Configuration** should be Custom.
 - Set **Compiler options string** and **Linker options string** should be blank.
- 3 Under **Link Automation**, verify that **Export IDE link handle to base workspace** is selected and provide a name for the handle in **Coder Target handle name** (optional).
- 4 Set the following **Run-Time** options:
 - **Build action**: `Build_and_execute`.
 - **Interrupt overrun notification method**: None.

You have configured the your software options that let you generate a project for you processor. You may have noticed that you did not configure a few of the Configuration Parameters panes, such as **Comments**, **Symbols**, and **Optimization**.

For your new model, the default values for the options in these panes are right. For other models you develop, you may want to set the options in these panes to provide information during the build and to run TLC debugging when you generate code. Refer to your product documentation for more information about setting the Configuration Parameters.

Building Your Project. After you set the Configuration Parameters and configure the coder product to create the files you need, you direct the build process to create your project:

- 1 Press **OK** to close the Configuration Parameters dialog.
- 2 Click **Ctrl+B** to generate your project into CCS IDE.

When you click **Build** with `Create_project` selected for **Build action**, the automatic build process starts CCS IDE, populates a new project in the development environment, builds the project, loads the binary on the processor, and runs it.

- 3 To stop processor execution, use the **Halt** option in CCS or enter `IDE_Obj.halt` at the MATLAB command prompt. (Where “IDE_Obj” is the IDE link handle name you specified previously in **Configuration Parameters**.)

Model Reference

Model reference lets your model include other models as modular components. This technique provides useful features because it:

- Simplifies working with large models by letting you build large models from smaller ones, or even large ones.
- Lets you generate code for the modules in the model, and later, regenerate code for modules that change.
- Lets you develop the modules independently.
- Lets you reuse modules and models by reference, rather than including the model or module multiple times in your model. Also, multiple models can refer to the same model or module.

Your product documentation provides much more information about model reference.

How Model Reference Works

Model reference behaves differently in simulation and in code generation. For this discussion, you need to know the following terms:

- **Top-model** — The root model block or model. It refers to other blocks or models. In the model hierarchy, this is the topmost model.
- **Referenced models** — Blocks or models that other models reference, such as models the top-model refers to. The models or blocks below the top-model in the hierarchy are reference models.

The following sections describe briefly how model reference works. More details are available in your product documentation in the online Help system.

Model Reference in Simulation. When you simulate the top-model, the coder product detects that your model contains referenced models. Simulink software generates code for the referenced models and uses the generated code to build shared library files for updating the model diagram and simulation. It also creates an executable (a MEX file, `.mex`) for each reference model that is used to simulate the top-model.

When you rebuild reference models for simulations or when you run or update a simulation, Simulink software rebuilds the model reference files. Whether reference files or models are rebuilt depends on:

- Whether and how you change the models.
- The **Rebuild** parameter on the **Model Reference** pane in the Configuration Parameters dialog.

Model Reference in Code Generation. Embedded Coder software requires executables to generate code from models. If you have not simulated your model at least once, the coder product creates a `.mex` file for simulation.

Next, for each referenced model, the code generation process calls `make_rtw` and builds each referenced model. This build process creates a library file for each of the referenced models in your model.

After building the referenced models, the coder product calls `make_rtw` on the top-model, linking to the library files it created for the associated referenced models.

Using Model Reference

With few limitations or restrictions, Embedded Coder provides full support for generating code from models that use model reference.

Build Action Setting. The most important requirement for using model reference with the TI's processors is to set the **Build action** for the Model blocks in the simulation to `Archive_library`.

To set the build action

- 1 Open your model.
- 2 Select **Simulation > Model Configuration Parameters** from the model menus.

The Configuration Parameters dialog opens.

- 3 Expand the node for the Code Generation pane. Then select the **Coder Target** pane.
- 4 In the right pane, under **Run-Time**, select `Archive_library` from the **Build action** list.

If your top-model uses a reference model that does not have the build action set to `Archive_library`, the build process automatically changes the build action to `Archive_library` and issues a warning about the change.

As a result of selecting the `Archive_library` setting, other options are disabled:

- DSP/BIOS is disabled for the referenced models. Only the top-model supports DSP/BIOS operation.
- **Interrupt overrun notification method**, **Export IDE link handle to base workspace**, and **System stack size** are disabled for the referenced models.

Other Block Limitations. Model reference with Embedded Coder does not allow you to use the following blocks or S-functions in reference models:

- Blocks from the C62x DSP Library (in `c6000lib`) (because these are noninlined S-functions)
- Blocks from the C64x DSP Library (in `c6000lib`) (because these are noninlined S-functions)
- Noninlined S-functions
- Driver blocks, such as the ADC or DAC blocks from a Embedded Coder block library

Configuring processors to Use Model Reference

Processors that you plan to use in Model Referencing must meet some general requirements.

- The **System target file** on the **Code Generation** pane of the **Configuration Parameters** dialog must match the target hardware.
- When you generate code from a model that references another model, you need to configure both the top-level model and the referenced models for the same code generation processor.
- The External mode option is not supported in model reference processor builds. Embedded Coder product does not support External mode. If you select this option, it is ignored during code generation.
- To support model reference builds, your TMF must support use of the shared utilities folder, as described in Supporting Shared Utility Directories in the Build Process in the Simulink Coder documentation.

To use an existing processor, or a new processor, with Model Reference, you set the `ModelReferenceCompliant` flag for the processor. For information on how to set this option, refer to `ModelReferenceCompliant` in the online Help system.

If you start with a model that was created prior to version 2.4 (R14SP3), to make your model compatible with the model reference processor, use the following command to set the `ModelReferenceCompliant` flag to On:

```
set_param(bdroot, 'ModelReferenceCompliant', 'on')
```

Models that you develop with versions 2.4 and later of Embedded Coder automatically include the model reference capability. You do not need to set the flag.

Exporting Filter Coefficients from FDATool

In this section...

“About FDATool” on page 42-69

“Preparing to Export Filter Coefficients to Code Composer Studio Projects” on page 42-70

“Exporting Filter Coefficients to Your Code Composer Studio Project” on page 42-74

“Preventing Memory Corruption When You Export Coefficients to Processor Memory” on page 42-80

About FDATool

Signal Processing Toolbox™ software provides the Filter Design and Analysis tool (FDATool) that lets you design a filter and then export the filter coefficients to a matching filter implemented in a CCS project.

Using FDATool with CCS IDE enables you to:

- Design your filter in FDATool
- Use CCS to test your filter on a processor
- Redesign and optimize the filter in FDATool
- Test your redesigned filter on the processor

For instructions on using FDATool, refer to the section “Filter Design and Analysis Tool” in the Signal Processing Toolbox documentation.

Procedures in this chapter show how to use the FDATool export options to export filter coefficients to CCS. Using these procedures, you can perform the following tasks:

- Export filter coefficients from FDATool in a header file—“Exporting Filter Coefficients from FDATool to the CCS IDE Editor” on page 42-75
- Export filter coefficients from FDATool to processor memory—“Replacing Existing Coefficients in Memory with Updated Coefficients” on page 42-82

Caution For the best results, export coefficients in a header file. Exporting coefficients directly to processor memory can generate unexpected results or corrupt memory.

Also see the reference pages for the following functions. These primary functions allow you use to access variables and write them to processor memory from the MATLAB Command window.

- `address` — Return the address of a symbol so you can read or write to it.
- `ticcs` — Create a connection between MATLAB software and CCS IDE so you can work with the project in CCS from the MATLAB Command window.
- `write` — Write data to memory on the processor.

Preparing to Export Filter Coefficients to Code Composer Studio Projects

- “Features of a Filter” on page 42-70
- “Selecting the Export Mode” on page 42-71
- “Choosing the Export Data Type” on page 42-72

Features of a Filter

When you create a filter in FDATool, the filter includes defining features identified in the following table.

Defining Feature	Description
Structure	Structure defines how the elements of a digital filter—gains, adders/subtractors, and delays—combine to form the filter. See the Signal Processing Toolbox documentation in the Online Help system for more information about filter structures.
Design Method	Defines the mathematical algorithm used to determine the filter response, length, and coefficients.

Defining Feature	Description
Response Type and Specifications	Defines the filter passband shape, such as lowpass or bandpass, and the specifications for the passband.
Coefficients	Defines how the filter structure responds at each stage of the filter process.
Data Type	Defines how to represent the filter coefficients and the resulting filtered output. Using a floating-point or fixed-point coefficient alters the filter response and output data values.

When you export your filter, FDATool exports only the number of and value of the filter coefficients and the data type used to define the coefficients.

Selecting the Export Mode

You can export a filter by generating an ANSI C header file, or by writing the filter coefficients directly to processor memory. The following table summarizes when and how to use the export modes.

To...	Use Export Mode...	When to Use	Suggested Use
Add filter coefficients to a project in CCS	C header file	You implemented a filter algorithm in your program, but you did not allocate memory on your processor for the filter coefficients.	<ul style="list-style-type: none"> • Add the generated ANSI C header file to a project. Building and loading this project into your processor allocates static memory locations on the processor and writes your filter coefficients to those locations. • Edit the file so the header file allocates extra processor memory and then add the header file to your project. Refer to “Allocating Extra Memory for Filter Coefficients” on page 42-80 in the next section.

To...	Use Export Mode...	When to Use	Suggested Use
			(For a sample generated header file, refer to “Reviewing ANSI C Header File Contents” on page 42-78.)
Modify the filter coefficients in an embedded application loaded on a processor	Write directly to memory	You loaded a program on your processor. The program allocated space in your processor memory to store the filter coefficients.	<ul style="list-style-type: none"> Optimize your filter design in FDATool. <p>Then,</p> <ul style="list-style-type: none"> Write the updated filter coefficients directly to the allocated processor memory. Refer to section “Preventing Memory Corruption When You Export Coefficients to Processor Memory” on page 42-80 for more information.

Choosing the Export Data Type

The export process provides two ways you can specify the data type to use to represent the filter coefficients. Select one of the options shown in the following table when you export your filter.

Specify Data Type for Export	Description
Export suggested	Uses the data type that FDATool suggests to preserve the fidelity of the filter coefficients and the performance of your filter in the project
Export as	Lets you specify the data type to use to export the filter coefficients

FDATool exports filter coefficients that use the following data types directly without modifications:

- Signed integer (8, 16, or 32 bits)
- Unsigned integer (8, 16, or 32 bits)

- Double-precision floating point (64 bits)
- Single-precision floating point (32 bits)

Filters in FDATool in the Signal Processing Toolbox software use double-precision floating point. You cannot change the data type.

If you have installed DSP System Toolbox software, you can use the filter quantization options in FDATool to set the word and fraction lengths that represent your filter coefficients. For information about using the quantization options, refer to Filter Design and Analysis Tool in the Filter Design Toolbox documentation in the Online help system.

If your filter uses one of the supported data types, **Export suggested** specifies that data type.

If your filter does not use one of the supported data types, FDATool converts the unsupported data type to one of the supported types and then suggests that data type. For more information about how FDATool determines the data type to suggest, refer to “How FDATool Determines the Export Suggested Data Type” on page 42-74.

Follow these best-practice guidelines when you implement your filter algorithm in source code and design your filter in FDATool:

- Implement your filter using one of the data types FDATool exports without modifications.
- Design your filter in FDATool using the data type you used to implement your filter.

To Choose the Export Data Type. When you export your filter, follow this procedure to select the export data type so that the exported filter coefficients closely match the coefficients of your filter in FDATool.

- 1** In FDATool, select **Targets > Code Composer Studio IDE** to open the Export to Code Composer Studio IDE dialog.
- 2** Perform one of the following actions:
 - Select **Export suggested** to export the coefficients in the suggested data type.

- Select **Export as** and choose the data type your filter requires from the list.

Caution If you select **Export as**, the exported filter coefficients can be very different from the filter coefficients in FDATool. As a result, your filter cutoff frequencies and performance may not match your design in FDATool.

How FDATool Determines the Export Suggested Data Type. By default, FDATool represents filter coefficients as double-precision floating-point data. When you export your filter coefficients, FDATool suggests the same data type.

If you set custom word and fraction lengths to represent your filter coefficients, the export process suggests a data type to maintain the best fidelity for the filter.

The export process converts your custom word and fraction lengths to a suggested export data type, using the following rules:

- Round the word length up to the nearest larger supported data type. For example, round an 18-bit word length up to 32 bits.
- Set the fraction length to the maintain the same difference between the word and fraction length in the new data type as applies in the custom data type.

For example, if you specify a fixed-point data type with word length of 14 bits and fraction length of 11 bits, the export process suggests an integer data type with word length of 16 bits and fraction length of 13 bits, retaining the 3 bit difference.

Exporting Filter Coefficients to Your Code Composer Studio Project

- “Exporting Filter Coefficients from FDATool to the CCS IDE Editor” on page 42-75
- “Reviewing ANSI C Header File Contents” on page 42-78

Exporting Filter Coefficients from FDATool to the CCS IDE Editor

In this section, you export filter coefficients to a project by generating an ANSI C header file that contains the coefficients. The header file defines global arrays for the filter coefficients. When you compile and link the project to which you added the header file, the linker allocates the global arrays in static memory locations in processor memory.

Loading the executable file into your processor allocates enough memory to store the exported filter coefficients in processor memory and writes the coefficients to the allocated memory.

Use the following steps to export filter coefficients from FDATool to the CCS IDE text editor.

- 1 Start FDATool by entering `fdatool` at the MATLAB command prompt.

```
fdatool      % Starts FDATool.
```

- 2 Design a filter with the same structure, length, design method, specifications, and data type you implemented in your source code filter algorithm.

The following figure shows a Direct-form II IIR filter example that uses second-order sections.

- 3 Click **Store Filter** to store your filter design. Storing the filter allows you to recall the design to modify it.
- 4 To export the filter coefficients, select **Targets > Code Composer Studio IDE** from the FDATool menu bar.

The Export to Code Composer Studio IDE dialog opens, as shown in the following figure.

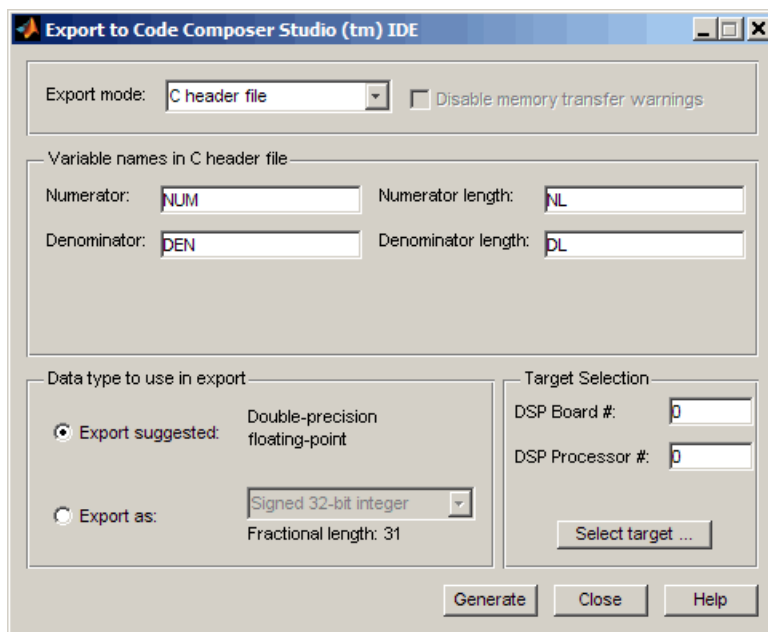

5 Set **Export mode** to **C header file**.



6 In **Variable names in C header file**, enter variable names for the **Numerator**, **Denominator**, **Numerator length**, and **Denominator length** parameters where the coefficients will be stored.

The dialog shows only the variables you need to export to define your filter.

Note You cannot use reserved ANSI C programming keywords, such as `if` or `int` as variable names, or include invalid characters such as spaces or semicolons (`;`).

- 7** In **Data type to use in export**, select **Export suggested** to accept the recommended export data type. FDATool suggests a data type that retains filter coefficient fidelity.

You may find it useful to select the **Export as** option and select an export data type other than the one suggested.

Caution If you deviate from the suggested data type, the exported filter coefficients can be very different from the filter coefficients in FDATool. As a result, your filter cutoff frequencies and performance may not match your design in FDATool.

For more information about how FDATool decides which data type to suggest, refer to “How FDATool Determines the Export Suggested Data Type” on page 42-74.

- 8** If you know the board number and processor number of your target, enter **DSP Board #** and **DSP Processor #** values to identify your board.

When you have only one board or simulator, Embedded Coder software sets **DSP Board #** and **DSP Processor #** values for your board automatically.

If you have more than one board defined in CCS Setup:

- Click **Select target** to open the Selection Utility dialog.
- From the list of boards and list of processors, select the board name and processor name to use.
- Click **Done** to set the **DSP Board #** and **DSP Processor #** values.

- 9** Click **Generate** to generate the ANSI header file. FDATool prompts you for a file name and location to save the generated header file.

The default location to save the file is your MATLAB working folder. The default file name is `fdacoeffs.h`.

- 10** Click **OK** to export the header file to the CCS editor.

If CCS IDE is not open, this step starts the IDE.

The export process does not add the file to your active project in the IDE.

- 11** Drag your generated header file into the project that implements the filter.
- 12** Add a `#include` statement to your project source code to include the new header file when you build your project.
- 13** Generate a `.out` file and load the file into your processor. Loading the file allocates locations in static memory on the processor and writes the filter coefficients to those locations.

To see an example header file, refer to “Reviewing ANSI C Header File Contents” on page 42-78.

Reviewing ANSI C Header File Contents

The following program listing shows the exported header (`.h`) file that FDATool generates. This example shows a direct-form II filter that uses five second-order sections. The filter is stable and has linear phase.

Comments in the file describe the filter structure, number of sections, stability, and the phase of the filter. Source code shows the filter coefficients and variables associated with the filter design, such as the numerator length and the data type used to represent the coefficients.

```
/*
 * Filter Coefficients (C Source) generated by the Filter Design and Analysis Tool
 *
 * Generated by MATLAB(R) 7.8 and the Signal Processing Toolbox 6.11.
 *
 * Generated on: xx-xxx-xxxx 14:24:45
 *
 */

/*
 * Discrete-Time IIR Filter (real)
 * -----
 * Filter Structure      : Direct-Form II, Second-Order Sections
 * Number of Sections  : 5
 * Stable                : Yes
 * Linear Phase         : No
```

```
*/

/* General type conversion for MATLAB generated C-code */
#include "tmwtypes.h"
/*
 * Expected path to tmwtypes.h
 * $MATLABROOT\extern\include\tmwtypes.h
 */
#define MWSPT_NSEC 11
const int NL[MWSPT_NSEC] = { 1,3,1,3,1,3,1,3,1,3,1 };
const real64_T NUM[MWSPT_NSEC][3] = {
    {
        0.802536131462,          0,          0
    },
    {
        0.2642710234701,  0.5285420469403,  0.2642710234701
    },
    {
        1,          0,          0
    },
    {
        0.1743690465012,  0.3487380930024,  0.1743690465012
    },

    {
        0.2436793028081,  0.4873586056161,  0.2436793028081
    },
    {
        1,          0,          0
    },
    {
        0.3768793219093,  0.7537586438185,  0.3768793219093
    },
    {
        1,          0,          0
    }
};
const int DL[MWSPT_NSEC] = { 1,3,1,3,1,3,1,3,1,3,1 };
```

```
const real164_T DEN[MWSPT_NSEC][3] = {
    {
        1,          0,          0
    },
    {
        1,  -0.1842138030775,  0.1775781189277
    },
    {
        1,          0,          0
    },
    {
        1,  -0.2160098642842,  0.3808329528195
    },
    {
        1,          0,          0
    }
};
```

Preventing Memory Corruption When You Export Coefficients to Processor Memory

- “Allocating Extra Memory for Filter Coefficients” on page 42-80
- “Using the Exported Header File to Allocate Extra Processor Memory” on page 42-81
- “Replacing Existing Coefficients in Memory with Updated Coefficients” on page 42-82
- “Changing Filter Coefficients Stored on Your Processor” on page 42-83

Allocating Extra Memory for Filter Coefficients

You can allocate extra memory by editing the generated ANSI C header file. You can then load the associated program file into your processor as described in “Using the Exported Header File to Allocate Extra Processor Memory” on page 42-81. Extra memory lets you change filter coefficients and overwrite existing coefficients stored in processor memory more easily.

To prevent problems when you update filter coefficients in a project, , such as writing coefficients to unintended memory locations, use the `C header file export mode` option in FDATool to update filter coefficients in your program.

Using the Exported Header File to Allocate Extra Processor Memory

You can edit the generated header file so the linked program file allocates extra processor memory. By allocating extra memory, you avoid the problem of insufficient memory when you export new coefficients directly to allocated memory.

For example, changing the following command in the header file:

```
const real64_T NUM[47] = {...}
```

to

```
real64_T NUM[256] = {...}
```

allocates enough memory for NUM to store up to 256 numerator filter coefficients rather than 47.

Exporting the header file to CCS IDE does not add the filter to your project. To incorporate the filter coefficients from the header file, add a `#include` statement:

```
#include "headerfilename.h"
```

Refer to “Exporting Filter Coefficients to Your Code Composer Studio Project” on page 42-74 for information about generating a header file to export filter coefficients.

When you export filter coefficients directly to processor memory, the export process writes coefficients to as many memory locations as they need. The write process does not perform bounds checking. Plan memory allocation carefully, so that the software writes to the right locations and has enough memory for filter coefficients.

Replacing Existing Coefficients in Memory with Updated Coefficients

When you redesign a filter and export new coefficients to replace existing coefficients in memory, verify the following conditions for your new design:

- Your redesign did not increase the memory required to store the coefficients beyond the allocated memory.

Changes that increase the memory required to store the filter coefficients include the following redesigns:

- Increasing the filter order
 - Changing the number of sections in the filter
 - Changing the numerical precision (changing the export data type)
- Your changes did not change the export data type.

Caution Identify changes that require additional memory to store the coefficients before you begin your export. Otherwise, exporting the new filter coefficients may overwrite data in memory locations you did not allocate for storing coefficients. Also, exporting filter coefficients to memory after you change the filter order, structure, design algorithm, or data type can yield unexpected results and corrupt memory.

Changing the filter design algorithm in FDATool, such as changing from Butterworth to Maximally Flat, often changes the number of filter coefficients (the filter order), the number of sections, or both. Also, the coefficients from the new design algorithm may not work with your source code filter implementation.

If you change the design algorithm, verify that your filter structure and length are the same after you redesign your filter, and that the coefficients will work with the filter you implemented.

If you change the number of sections or the filter order, your filter will not work well unless your filter algorithm implementation accommodates the changes.

Changing Filter Coefficients Stored on Your Processor

This example writes filter coefficients to processor memory to replace the existing coefficients. To perform this process, you need the names of the variables in which your project stores the filter data.

Before you export coefficients directly to memory, verify that your project allocated enough memory for the new filter coefficients. If your project allocated enough memory, you can modify your filter in FDATool and then follow the steps in this example to export the updated filter coefficients to the allocated memory.

If your new filter requires additional memory space, use a C header file to allocate memory on the processor and export the new coefficients as described in “Exporting Filter Coefficients to Your Code Composer Studio Project” on page 42-74.

For important guidelines on writing directly to processor memory, refer to “Preventing Memory Corruption When You Export Coefficients to Processor Memory” on page 42-80.

Follow these steps to export filter coefficients from FDATool directly to memory on your processor.

- 1** Load the program file that contains your filter into CCS IDE to activate the program symbol table. The symbol must contain the global variables you use to store the filter coefficients and length parameters.
- 2** Start FDATool.
- 3** Click **Filter Manager** to open the Filter Manager dialog, shown in the following figure.

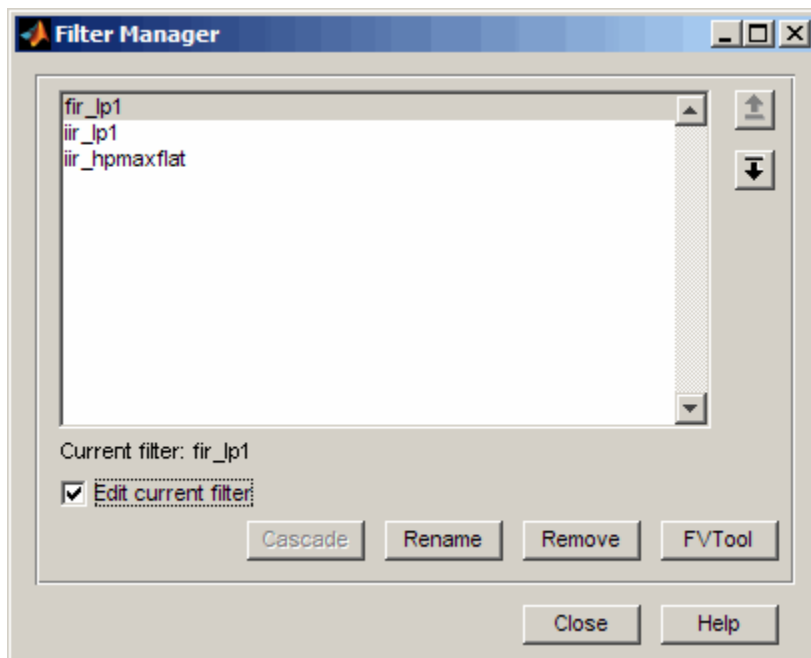

- 4** Highlight the filter to modify on the list of filters, and select **Edit current filter**. The highlighted filter appears in FDATool for you to change.

If you did not store your filter from a previous session, design the filter in FDATool and continue.

- 5** Click **Close** to dismiss the Filter Manager dialog.
- 6** Adjust the filter specifications in FDATool to modify its performance.
- 7** In FDATool, select **Targets > Code Composer Studio IDE** to open the Export to Code Composer Studio IDE dialog.

Keep the export dialog open while you work. When you do so, the contents update as you change the filter in FDATool.

Tip Click **Generate** to export coefficients to the same processor memory location multiple times without reentering variable names.

- 8 In the Export to Code Composer Studio dialog:
 - Set **Export mode** to Write directly to memory
 - Clear **Disable memory transfer warnings** to get a warning if your processor does not support the export data type.
- 9 In **Variable names in target symbol table**, enter the names of the variables in the processor symbol table that correspond to the memory allocated for the parameters, such as **Numerator** and **Denominator**. Your names must match the names of the filter coefficient variables in your program.

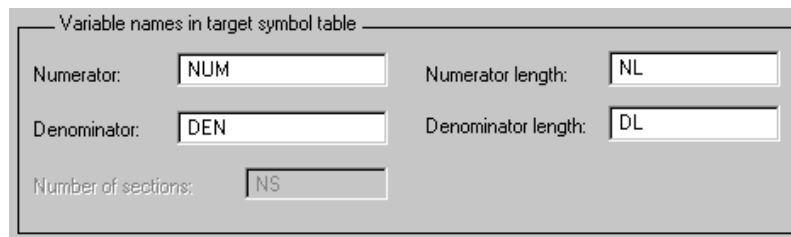

Variable names in target symbol table

Numerator:	<input type="text" value="NUM"/>	Numerator length:	<input type="text" value="NL"/>
Denominator:	<input type="text" value="DEN"/>	Denominator length:	<input type="text" value="DL"/>
Number of sections:	<input type="text" value="NS"/>		

- 10 Select **Export suggested** to accept the recommended export data type.

For more information about how FDATool determines the data type to suggest, refer to “How FDATool Determines the Export Suggested Data Type” on page 42-74.

- 11 If you know the board number and processor number of your target, enter **DSP Board #** and **DSP Processor #** values to identify your board.

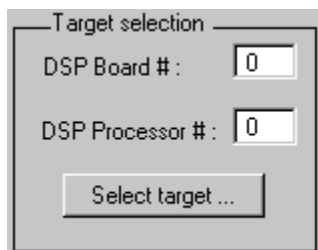

Note When you have only one board or simulator, Embedded Coder sets **DSP Board #** and **DSP Processor #** to your board automatically.

If you have more than one board defined in CCS Setup:

- Click **Select target** to open the Selection Utility dialog.
- Select the board name and processor name to use from the list of boards.

12 Click **Generate** to export your filter. If your processor does not support the data type you export, you see a warning similar to the following message.

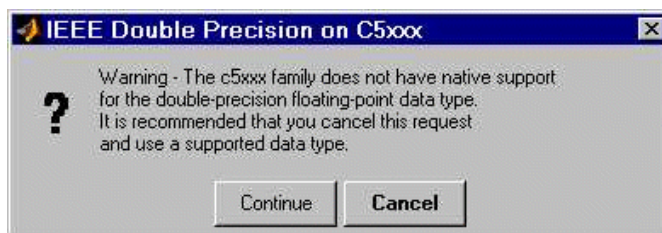

You can continue to export the filter, or cancel the export process. To prevent this warning dialog from appearing, select **Disable memory transfer warnings** in the Export to Code Composer Studio IDE dialog.

- 13** (Optional) Continue to optimize filter performance by modifying your filter in FDATool and then export the updated filter coefficients directly to processor memory.
- 14** When you finish testing your filter, return to FDATool, and click **Store filter** to save your changes.

Using Makefiles with Code Composer Studio 3.x

In this section...

“Introduction” on page 42-87

“Set Up XMakefile for CCSv3” on page 42-87

“Prepare Your Model for CCSv3 and Makefiles” on page 42-89

“Create Target Configuration File in CCSv3” on page 42-89

“Load and Run the Embedded Software” on page 42-90

Introduction

This tutorial shows you how to use the XMakefile feature in your MathWorks software to build and run embedded software with Code Composer Studio 3.3 (CCSv3). For more information about XMakefile, see “Makefiles for Software Build Tool Chains” on page 35-21

Note The Embedded Coder IDE Project Generator feature is not available for CCSv3 in the current release. For more information about IDE Project Generator, see “IDE Projects” on page 35-16

To build the target software, complete the process covered in this chapter:

- Set up XMakefile for CCSv3.
- Prepare your model for CCSv3.
- Create a Target Configuration File in CCSv3.
- Load and run the embedded software.

Set Up XMakefile for CCSv3

The XMakefile feature tells your MathWorks software how to create makefiles for a *configuration*, which is a specific combination of tool chain and embedded target hardware. Some configurations require additional information before you can use them.

Select and complete a configuration for Code Composer Studio 3.3 (CCSv3):

- 1** Enter `xmakefilesetup` at the MATLAB command prompt. This action opens the XMakefile User Configuration dialog.
- 2** Clear **Display operational configurations only**. This displays the configuration files, including ones that need updated path information.
- 3** For **Configurations**, select a configuration that matches your target and ends with `ccsv3`. Then click **Apply**.
- 4** If the configuration is incomplete, the software displays a series of **Browse For Folder** dialogues that include instructions to provide missing information.
- 5** Examine the **Tool Directories** tab to see if the paths are right.
- 6** When you have supplied the missing information, and the configuration is complete, click **OK** to close the XMakefile User Configuration dialog.

For example, to generate code for CCSv3 and a C6000 processor with DSP/BIOS:

- 1** Enter `xmakefilesetup` on the command line.
- 2** In the XMakefile dialog, clear **Display operational configurations only**, set **Configurations** to `ticcs_c6000_dspbios_ccsv3`, and click **Apply**.
- 3** A **Browse For Folder** appears, stating “Select the C6000 Code Generation Tools root installation directory...”.

Browse and select a path such as `C:\Program Files\Texas Instruments\C6000 Code Generation Tools`.

- 4** Another **Browse For Folder** dialog appears, stating “Select the C6000 CSL root installation directory...”.

Browse and select a path such as `C:\Program Files\C6xCSL\`.

- 5** Examine the **Tool Directories** tab to see if the paths are right.

- 6 With the updated information, the `ticcs_c6000_dspbios_ccsv3` configuration is operational. Click **OK** to save the updated configuration, and close the dialog.

Prepare Your Model for CCSv3 and Makefiles

- 1 Configure your model as described in “Configure Target Hardware Resources” on page 35-3
- 2 On the Coder Target pane, under the Tool Chain Automation tab, set **Build format** to **Makefile**.
- 3 Build your embedded software by pressing **CTRL+B**.

Create Target Configuration File in CCSv3

Before loading and running your target software, use the CCSv3 IDE to create a “target configuration file”. The TI Debug Server uses this file while it works with CCSv3 to load and run your target software. The XML-based target configuration file describes the target board and processor. The file name ends with a `*.ccxml` extension.

Create a target configuration file:

- 1 In the CCSv3, select **File > New > Target Configuration File** to display a **New Target Configuration** dialog:
 - For **File name**, update the file name that ends with `.ccxml` to describe your project and hardware.
 - Click **Finish**. This action displays a utility in the CCS editor pane for customizing the target configuration file.
- 2 Use the utility to select the **Connection** and **Device** type. Typing a partial string next to **Device** filters the list of devices.
- 3 Click **Save**.

Note For more information about target configuration files, consult the Texas Instruments documentation for CCSv3.

Load and Run the Embedded Software

First set the Windows system variable, Path, so you can call the TI Debug Server Scripting (DSS) API from a folder.

- 1 In Windows, right-click **My Computer**, and select **Properties**. This action opens the System Properties dialog.
- 2 In **System Properties**, select the **Advanced** tab, and click **Environment Variables**. This action opens the Environment Variables dialog.
- 3 In **Environment Variables**, under **System variables**, select the Path variable, and click **Edit**. This action opens the Edit System Variable dialog.
- 4 In Edit System Variable, for **Variable value**, append a semicolon and the full path of the `\ccsv3\scripting\bin` subdirectory. For example, append `;C:\ti\ccsv3\scripting\bin`.

Note The path cannot contain spaces. Customize the installation directory when you install CCSv3 so it does not contain spaces.

For more information about using DSS, see http://processors.wiki.ti.com/index.php/Debug_Server_Scripting.

MathWorks provides an example JavaScript file, `runProgram.js`, for you to use with DSS. This script loads and runs the specified program on the target specified in the target configuration file. You can create a copy of this script and modify it to suit your needs. The location of `runProgram.js` is:

```
[MATLABROOT]\toolbox\idelink\extensions\ticcs\ccsdemos
```

The specific syntax for running `dss.bat` with `runProgram.js` is:

```
> dss runProgram.js targetConfigurationFile programFile
```

Replace *targetConfigurationFile* and *programFile* with paths and file names. For example, if you are using a working directory called the CCSv3 workspace, and the model name is `myProgram`, enter:

```
> dss runProgram.js c:\workspace\myC6416dsk.ccxm1 myProgram.out
```

This command builds and loads your software on the target or simulator.

You have completed the process of loading and running embedded software using XMakefile and CCSv3.

Reported Limitations and Tips

In this section...
“Example Programs Do Not Run Well with Incorrect GEL Files” on page 42-93
“Changing Values of Local Variables Does Not Work” on page 42-93
“Code Composer Studio Cannot Find a File After You Halt a Program” on page 42-94
“C54x XPC Register Can Be Modified Only Through the PC Register” on page 42-95
“Working with More Than One Installed Version of Code Composer Studio” on page 42-96
“Changing CCS Versions During a MATLAB Session” on page 42-96
“MATLAB Hangs When Code Composer Studio Cannot Find a Board” on page 42-96
“Using Mapped Drives” on page 42-98
“Uninstalling Code Composer Studio 3.3 Prevents Embedded Coder From Connecting” on page 42-98
“PostCodeGenCommand Commands Do Not Apply to IDE Projects” on page 42-98

Some long-standing issues apply to the Embedded Coder product. When you are using `ticcs` objects and the software methods to work with Code Composer Studio and supported hardware or simulators, recall the information in this section.

The latest issues in the list appear at the bottom. HIL refers to “hardware in the loop,” also called processor in the loop (PIL) here and in other applications, and sometimes referred to as function calls.

Example Programs Do Not Run Well with Incorrect GEL Files

To run the Embedded Coder examples, you must load the corresponding GEL files before you run the examples. For some boards, the examples run fine with the default CCS GEL file. Some boards need to run device-specific GEL files for the examples to work well.

Here are examples and boards which require specific GEL files.

- Board: C5416 DSK
Examples: `rtdxtutorial`, `rtdx1msdemo`
Emulator: XDS-510
GEL file to load: `c5416_dsk.gel`

In general, if a example does not run with the default GEL file, try using a device-specific GEL file by defining the file in the CCS Setup Utility.

Changing Values of Local Variables Does Not Work

If you halt the execution of your program on your DSP and modify a local variable's value, the new value may not be acknowledged by the compiler. If you continue to run your program, the compiler uses the original value of the variable.

This problem happens only with local variables. When you write to the local variable via the Code Composer Studio Watch Window or via a MATLAB object, you are writing into the variable's absolute location (register or address in memory).

However, within the processor function, the compiler sometimes saves the local variable's values in an intermediate location, such as in another register or to the stack. That intermediate location cannot be determined or changed/updated with a new value during execution. Thus the compiler uses the old, unchanged variable value from the intermediate location.

Code Composer Studio Cannot Find a File After You Halt a Program

When you halt a running program on your processor, Code Composer Studio may display a dialog that says it cannot find a source code file or a library file.

When you halt a program, CCS tries to display the source code associated with the current program counter. If the program stops in a system library like the runtime library, DSP/BIOS, or the board support library, it cannot find the source code for debug. You can either find the source code to debug it or select the **Don't show this message again** check box to ignore messages like this in the future.

For more information about how CCS responds to the halt, refer the online Help for CCS. In the online help system, use the search engine to search for the keywords “Troubleshooting” and “Support.” The following information comes from the online help for CCS, starting with the error message:

File Not Found

The debugger is unable to locate the source file required to enable source-level debugging for this program.

To specify the location of the source file

- 1** Click **Yes**. The Open dialog appears.
- 2** In the Open dialog, specify the location and name of the source file then click **Open**.

The next section provides more details about file paths.

Defining a Search Path for Source Files

The Directories dialog enables you to specify the search path the debugger uses to find the source files included in a project.

To Specify Search Path Directories

- 1** Select **Option > Customize**.

- 2 In the Customize dialog, select the **Directories** tab. Use the scroll arrows at the top of the dialog to locate the tab.

The Directories dialog offers the following options.

- **Directories.** The **Directories** list displays the defined search path. The debugger searches the listed folders in order from top to bottom.
If two files have the same name and are located in different folders, the file located in the folder that appears highest in the **Directories** list takes precedence.
- **New.** To add a new folder to the **Directories** list, click **New**. Enter the full path or click **browse [...]** to navigate to a folder. By default, the new folder is added to the bottom of the list.
- **Delete.** Select a folder in the **Directories** list, then click **Delete** to remove that folder from the list.
- **Up.** Select a folder in the **Directories** list, then click **Up** to move that folder higher in the list.
- **Down.** Select a folder in the **Directories** list, then click **Down** to move that folder lower in the list.

- 3 Click **OK** to close the Customize dialog and save your changes.

C54x XPC Register Can Be Modified Only Through the PC Register

You cannot modify the XPC register value directly using `regwrite` to write into the register. When you are using extended program addressing in C54x, you can modify the XPC register by using `regwrite` to write a 23-bit data value in the PC register. Along with the 16-bit PC register, this operation also modifies the 7-bit XPC register that is used for extended program addressing. On the C54x, the PC register is 23 bits (7 bits in XPC + 16 bits in PC).

You can then read the XPC register value using `regread`.

Working with More Than One Installed Version of Code Composer Studio

When you have more than one version of Code Composer Studio installed on your machine, you cannot select which CCS version MATLAB Embedded Coder attaches to when you create a `ticcs` object. If, for example, you have both CCS for C5000 and CCS for C6000 versions installed, you cannot choose to connect to the C6000 version rather than the C5000 version.

When you issue the command

```
IDE_obj = ticcs
```

Embedded Coder starts the CCS version you last used. If you last used your C5000 version, the `IDE_obj` object accesses the C5000 version.

Workaround

To make your `ticcs` object access the right processor:

- 1 Start and close the CCS version you plan to use before you create the `ticcs` object in MATLAB.
- 2 Create the `ticcs` object using the `boardnum` and `procnum` properties to select your processor, if required.

Recall that `ccsboardinfo` returns the `boardnum` and `procnum` values for the processors that CCS recognizes.

Changing CCS Versions During a MATLAB Session

You can use only one version of CCS in a single MATLAB session. Embedded Coder does not support using multiple versions of CCS in a MATLAB session. To use another CCS version, exit MATLAB software and restart it. Then create your links to the new version of CCS.

MATLAB Hangs When Code Composer Studio Cannot Find a Board

In MATLAB software, when you create a `ticcs` object, the construction process for the object automatically starts CCS. If CCS cannot find a processor

that is connected to your PC, you see a message from CCS like the following DSP Device Driver dialog that indicates CCS could not initialize the processor.

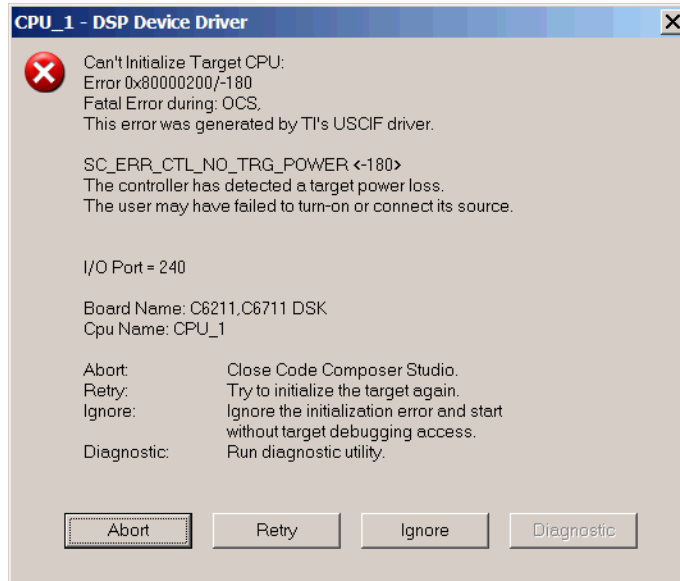

Four options let you decide how to respond to the failure:

- **Abort** — Closes CCS and suspends control for about 30 seconds. If you used MATLAB software functions to open CCS, such as when you create a `ticcs` object, the system returns control to MATLAB command window after a considerable delay, and issues this warning:

```
??? Unable to establish connection with Code Composer Studio.
```
- **Ignore** — Starts CCS without connecting to a processor. In the CCS IDE you see a status message that says `EMULATOR DISCONNECTED` in the status area of the IDE. If you used MATLAB to start CCS, you get control immediately and Embedded Coder creates the `ticcs` object. Because CCS is not connected to a processor, you cannot use the object to perform processor operations from MATLAB, such as loading or running programs.
- **Retry** — CCS tries again to initialize the processor. If CCS continues not to find your hardware processor, the same DSP Device Driver dialog

reappears. This process continues until either CCS finds the processor or you choose one of the other options to respond to the warning.

One more option, **Diagnostic**, lets you enter diagnostic mode if it is enabled. Usually, **Diagnostic** is not available for you to use.

Using Mapped Drives

Limitations in Code Composer Studio do not allow you to load programs after you set your CCS working folder to a read-only mapped drive. Load operations fail with an Application Error dialog.

The following combination of commands does not work:

```
1 cd(IDE_obj, 'mapped_drive_letter') % Change CCS working
  directory to read-only mapped drive.
2 load(IDE_obj, 'program_file') % Loading program fails.
```

Uninstalling Code Composer Studio 3.3 Prevents Embedded Coder From Connecting

Description On a machine where CCS 3.3 and CCS 3.1 are installed, uninstalling 3.3 makes 3.1 unusable from MATLAB. This is because the CCS 3.3 uninstaller leaves stale registry entries in the Windows Registry that prevent MATLAB from connecting to CCS 3.1.

Texas Instruments has documented this uninstall problem and the solution on their Web site.

Updated information on this issue may also be available from the Bug Reports section of www.mathworks.com at <http://www.mathworks.com/support/bugreports/379676>

PostCodeGenCommand Commands Do Not Apply to IDE Projects

PostCodeGenCommand commands, such as the addCompileFlags and addLinkFlags functions in the BuildInfo API do not alter code generated

by Embedded Coder while **System Target File** is set to `idelink_ert.tlc` or `idelink_grt.tlc`.

Use the 'Compiler options string' and 'Linker options string' parameters located in the Configuration Parameters dialog (**Ctrl+E**) on the Code Generation > Coder Target pane instead. You can also automate this process using a model callback to SET_PARAM the 'CompilerOptionsStr' and 'LinkerOptionsStr' parameters.

Working with Texas Instruments Code Composer Studio 4 & 5 IDE

- “Code Composer Studio” on page 43-2
- “Getting Started” on page 43-3
- “Using Makefiles with Code Composer Studio 4 & 5” on page 43-4
- “Reported Limitations and Tips” on page 43-10

Code Composer Studio

Feature Support

When you use Code Composer Studio 4 or Code Composer Studio 5 with Embedded Coder software, you can use:

- Makefiles to automate building and deploying software to target hardware. For more information, see “Makefiles for Software Build Tool Chains” on page 35-21 and “Using Makefiles with Code Composer Studio 4 & 5” on page 43-4.
- Processor-in-the-loop (PIL) simulations to verify your software running on target hardware. For more information, see “Processor-in-the-Loop (PIL) Simulation” on page 36-2.
- Execution profiling with PIL to measure the performance of synchronous tasks running on target hardware. For more information, see “Execution Profiling during PIL Simulation” on page 36-25.

Features that require IDE projects (**Build format = Project**), such as IDE Project Generator and IDE Automation Interface, are not available for use with Code Composer Studio 4 & 5.

You can use CCSv4/5 with the Simulink Block Libraries for the following Texas Instruments processors:

- TI's C2000
- TI's C5000
- TI's C6000

Getting Started

In this section...
“Verifying Your Code Composer Studio Installation” on page 43-3
“Learning About Makefiles” on page 43-3

Verifying Your Code Composer Studio Installation

On your host computer, install CCSv4/5 and other third-party tools for your board and processor, and set the environment variables. Then use the `checkEnvSetup` function in MATLAB to verify that your setup includes the required software. For more information and examples, see `checkEnvSetup`.

Learning About Makefiles

To learn about using makefiles, see “Makefiles for Software Build Tool Chains” on page 35-21.

For an example of using CCSv4/5 with makefiles, model-block PIL, and the Serial Communications Interface (SCI), see “Performing a Model Block PIL Simulation via SCI Using Makefiles” on page 36-14.

Using Makefiles with Code Composer Studio 4 & 5

In this section...

“Introduction” on page 43-4

“Set Up XMakefile for CCSv4/5” on page 43-4

“Prepare Your Model for CCSv4/5 and Makefiles” on page 43-6

“Create Target Configuration File in CCSv4/5” on page 43-6

“Configure Windows Path for TI Debug Server Scripting (DSS)” on page 43-7

“Load and Run the Embedded Software Using DSS” on page 43-7

Introduction

This tutorial shows you how to use the XMakefile feature in your MathWorks software to build and run embedded software with Code Composer Studio 4 or 5 (CCSv4/5). For more information about XMakefile, see “Makefiles for Software Build Tool Chains” on page 35-21

Note The Embedded Coder IDE Project Generator feature is not available for CCSv4/5 in the current release. For more information about IDE Project Generator, see “IDE Projects” on page 35-16

To build the target software, complete the process covered in this chapter:

- Set up XMakefile for CCSv4/5.
- Prepare your model for CCSv4/5.
- Create a Target Configuration File in CCSv4/5.
- Load and run the embedded software.

Set Up XMakefile for CCSv4/5

The XMakefile feature tells your MathWorks software how to create makefiles for a *configuration*, which is a specific combination of tool chain and embedded

target hardware. Some configurations require additional information before you can use them.

Select and complete a configuration for Code Composer Studio 4 & 5 (CCSv4/5):

- 1** Enter `xmakefilesetup` at the MATLAB command prompt. This action opens the XMakefile User Configuration dialog.
- 2** Clear **Display operational configurations only**. This displays the configuration files, including ones that need updated path information.
- 3** For **Configurations**, select a configuration that matches your target and ends with `ccsv4` or `ccsv5`. Then click **Apply**.
- 4** If the configuration is incomplete, the software displays a series of **Browse For Folder** dialogues that include instructions to provide missing information.
- 5** Examine the **Tool Directories** tab to see if the paths are right.
- 6** When you have supplied the missing information, and the configuration is complete, click **OK** to close the XMakefile User Configuration dialog.

For example, to generate code for CCSv4/5 and a C6000 processor with DSP/BIOS:

- 1** Enter `xmakefilesetup` on the command line.
- 2** In the XMakefile dialog, clear **Display operational configurations only**, set **Configurations** to `ticcs_c6000_dspbios_ccsv4` or `ticcs_c6000_dspbios_ccsv5`, and click **Apply**.
- 3** A **Browse For Folder** appears, stating “Select the C6000 Code Generation Tools root installation directory...”.

Browse and select a path such as `C:\Program Files\Texas Instruments\C6000 Code Generation Tools`.

- 4** Another **Browse For Folder** dialog appears, stating “Select the C6000 CSL root installation directory...”.

Browse and select a path such as C:\Program Files\C6xCSL\.

- 5** Examine the **Tool Directories** tab and verify the paths shown there. Verify the DSP/BIOS and XDC installation folders.
- 6** With the updated information, the `ticcs_c6000_dspbios_ccsv4` or `ticcs_c6000_dspbios_ccsv5` configuration is operational. Click **OK** to save the updated configuration, and close the dialog.

Prepare Your Model for CCSv4/5 and Makefiles

- 1** Configure your model as described in “Configure Target Hardware Resources” on page 35-3, setting **IDE/Tool Chain** to Texas Instruments Code Composer Studio v4 (makefile generation only) or Texas Instruments Code Composer Studio v5 (makefile generation only).

Choosing either of those options automatically sets **Build format** to **Makefile**.

- 2** Build your embedded software by pressing **CTRL+B**.

Create Target Configuration File in CCSv4/5

Before loading and running your target software, use the CCSv4/5 IDE to create a “target configuration file”. The TI Debug Server uses this file while it works with CCSv4/5 to load and run your target software. The XML-based target configuration file describes the target board and processor. The file name ends with a `*.ccxml` extension.

Create a target configuration file:

- 1** In the CCSv4/5, select **File > New > Target Configuration File** to display a **New Target Configuration** dialog:
 - For **File name**, update the file name that ends with `.ccxml` to describe your project and hardware.
 - Click **Finish**. This action displays a utility in the CCSv4/5 editor pane for customizing the target configuration file.
- 2** Use the utility to select the **Connection** and **Device** type. Typing a partial string next to **Device** filters the list of devices.

3 Click **Save**.

Note For more information about target configuration files, consult the Texas Instruments documentation for CCSv4/5.

Configure Windows Path for TI Debug Server Scripting (DSS)

Set the Windows system variable, Path, so you can call the TI Debug Server Scripting (DSS) API from a folder.

- 1 In Windows, right-click **My Computer**, and select **Properties**. This action opens the System Properties dialog.
- 2 In **System Properties**, select the **Advanced** tab, and click **Environment Variables**. This action opens the Environment Variables dialog.
- 3 In **Environment Variables**, under **System variables**, select the Path variable, and click **Edit**. This action opens the Edit System Variable dialog.
- 4 In Edit System Variable, for **Variable value**, append a semicolon and the full path of the `\ccsv4\scripting\bin` or `\ccsv5\scripting\bin` subdirectory. For example, append `;C:\ti\ccsv4\scripting\bin`.

Note The path cannot contain spaces. Customize the installation directory when you install CCSv4/5 so it does not contain spaces.

Load and Run the Embedded Software Using DSS

MathWorks provides an example JavaScript file, `runProgram.js`, for you to use with DSS. This script loads and runs the specified program on the target specified in the target configuration file. You can create a copy of this script and modify it to suit your needs. The location of `runProgram.js` is:

```
[MATLABROOT]\toolbox\idelink\extensions\ticcs\ccsdemos
```

The specific syntax for running `dss.bat` with `runProgram.js` is:

```
> dss runProgram.js targetConfigurationFile programFile
```

Replace *targetConfigurationFile* and *programFile* with paths and file names. For example, if you are using a working directory called the CCSv4/5 workspace, and the model name is myProgram, enter:

```
> dss runProgram.js c:\workspace\myC6416dsk.ccxml myProgram.out
```

This command loads and runs your software on the target or simulator.

You have completed the process of loading and running embedded software using XMakefile and CCSv4/5.

For more information about using DSS, see http://processors.wiki.ti.com/index.php/Debug_Server_Scripting.

Troubleshooting DSS

With Code Composer Studio 4 & 5, using runProgram.js to download and run the generated program file can produce an error message similar to:

```
SEVERE: Could not open session. Found 2 devices matching: .*  
Spectrum Digital DSK-EVM-eZdsp onboard USB Emulator_0/C64XP_0  
Spectrum Digital DSK-EVM-eZdsp onboard USB Emulator_0/IcePick_C_0
```

If this happens, specify one of the devices in line 65 in runProgram.js. For example:

```
debugSession = debugServer.openSession(".*C64XP.*");
```

Alternatively, to connect to the first board & CPU detected, use ("*", "*") in line 65. For example:

```
debugSession = debugServer.openSession("*", "*");
```

Remember to restore the original code to work with other devices.

Advanced DSS Features

To use advanced DSS features, you can also use the CCSv4/5 example batch file, loadti.bat, as follows:

Change directories to the loadti subdirectory. For example:

```
> cd c:\ccs4_install\ccsv4\scripting\examples\loadti
```

Run loadti.bat using the following syntax:

```
> loadti -a -c=targetConfigurationFile programFile
```

Replace targetConfigurationFile with the complete path of the target configuration file.

Replace programFile with the name of the .out created using the XMakefile feature. For example:

```
> loadti -a -c=c:\workspace\myC6416dsk.ccxml myProgram.out
```

For more information about loadti and its options, type the following on your system command prompt

```
> loadti -help
```

Reported Limitations and Tips

In this section...

“Example Programs Do Not Run well with Incorrect GEL Files” on page 43-10

“PostCodeGenCommand Commands Do Not Apply to IDE Projects” on page 43-10

Some long-standing issues apply to the Embedded Coder product.

Example Programs Do Not Run well with Incorrect GEL Files

To run the Embedded Coder examples, you must load the GEL files before you run the examples. For some boards, the examples run fine with the default CCSv4/5 GEL file. Some boards need to run device-specific GEL files for the examples to work.

Here are examples and boards which require specific GEL files.

- Board: C5416 DSK
Examples: `rtdxtutorial`, `rtdx1msdemo`
Emulator: XDS-510
GEL file to load: `c5416_dsk.gel`

In general, if a example does not run with the default GEL file, try using a device-specific GEL file by defining the file in the CCSv4/5 Setup Utility.

PostCodeGenCommand Commands Do Not Apply to IDE Projects

PostCodeGenCommand commands, such as the `addCompileFlags` and `addLinkFlags` functions in the BuildInfo API do not alter code generated while **System Target File** is set to `idelink_ert.tlc` or `idelink_grt.tlc`.

Use the 'Compiler options string' and 'Linker options string' parameters located in the Configuration Parameters dialog (**Ctrl+E**) on the **Code Generation > Coder Target** pane instead. You can also automate this process using a model callback to SET_PARAM the 'CompilerOptionsStr' and 'LinkerOptionsStr' parameters.

Working with Texas Instruments C2000 Processors

- “Setting Up and Configuring” on page 44-3
- “Data Type Support” on page 44-6
- “Scheduling and Timing” on page 44-7
- “Sharing General Purpose Timers between C281x Peripherals” on page 44-13
- “Overview of Creating Models for C2000 Processors” on page 44-22
- “Using the c2000lib Blockset” on page 44-24
- “Configuring Timing Parameters for CAN Blocks” on page 44-30
- “ADC-PWM Synchronization via ADC Interrupt” on page 44-49
- “Configuring Acquisition Window Width for ADC Blocks” on page 44-54
- “Real-Time Data Exchange via RTDX™” on page 44-61
- “SPI-Based Control of PWM Duty Cycle” on page 44-63
- “HIL Verification of IIR Filter via SCI” on page 44-67
- “CAN-Based Control of PWM Duty Cycle” on page 44-74
- “CAN Calibration Protocol and External Mode” on page 44-77
- “Using the I2C Bus to Access a Connected EEPROM” on page 44-85
- “Using the IQmath Library” on page 44-90

- “Programming Flash Memory” on page 44-99
- “Configuring LIN Communications” on page 44-105
- “Tips and Limitations” on page 44-108

Setting Up and Configuring

In this section...

“Feature Support for Code Composer Studio” on page 44-3

“Installing and Configuring Software” on page 44-3

“Verifying the Configuration” on page 44-4

Feature Support for Code Composer Studio

The “Working with Texas Instruments C2000 Processors” section of the User’s Guide contains some references to the IDE Automation Interface and IDE Project Generator components. Embedded Coder supports these two components with Code Composer Studio 3.3 (CCSv3). Embedded Coder does not support these components with Code Composer Studio 4 & 5 (CCSv4/5).

For more information about Embedded Coder support for CCSv3 and CCSv4/5, see “Working with Texas Instruments Code Composer Studio IDE”.

Installing and Configuring Software

Uninstall unsupported or untested versions of the third party products *before* installing supported versions. This prevents errors that occur when the Windows Environment Variables point to the unsupported versions.

Before you install the software, if you are installing Texas Instruments (TI) Code Composer Studio CCSv3 on Windows 7, make sure that:

- You have administrator privileges.
- You have set the User Account Control (UAC) settings to the lowest level.
- You install CCSv3 in a folder other than Program Files.

Go to the vendor Web sites to find 64-bit compatible drivers for installing CCSv3 on 64-bits machine with drivers such as, Spectrum Digital Emulators or BlackHawk Emulators. Most vendors have 64-bit drivers that are compatible with CCSv3.

For the Host side CAN functionality, you must install 32-bit version of MATLAB on 64-bit machines.

Install the software in the following order:

- 1** Install the required and optional MathWorks software. The software license you purchase determines which products are available.
- 2** Install TI CCS.
- 3** Install TI Service Release for CCS.
- 4** Install the TI Code Generation Tools for Windows.
- 5** If you are using a Spectrum Digital board, download and install the matching Spectrum Digital Driver.
- 6** If you are using RTDX for C28x host/target communications, download and install TI DSP/BIOS.
- 7** If you program flash memory with standalone code, download the TI Flash API for your target hardware.

Configure CCSv3 as follows:

- 1** In CCSv3, open **Help > About > Component manager > Build tools > TMS320C28XX** and select (check) **C2000 Code Generation Tools** .
- 2** With the Component manager open, open **Target Content (DSP/BIOS) > TMS320C28XX** and select **Texas Instruments DSP/BIOS**.
- 3** Save, exit, and restart CCSv3.

Verifying the Configuration

To determine whether Embedded Coder software is present on your system, enter this command at the MATLAB prompt:

```
c2000lib
```

MATLAB displays the C2000 block libraries.

If you do not see the listed libraries, or MATLAB does not recognize the command, install the Embedded Coder software. Without the software, you cannot use Simulink and Simulink Coder software to develop applications targeted to the TI boards.

To verify that Code Composer Studio 3.3 (CCSv3) is present on your machine, enter this command at the MATLAB prompt:

```
ccsboardinfo
```

With CCSv3 installed and configured, MATLAB returns a list of the boards that CCSv3 recognizes on your machine like the following example:

Board Num	Board Name	Proc Num	Processor Name	Processor Type
1	F2812 Simulator	0	CPU	TMS320C28xx
0	F2812 PP Emulator	0	CPU_1	TMS320C28xx

If MATLAB does not return information about boards, revisit the installation and setup instructions in your CCSv3 documentation. If you have not done so already, install the third-party “Board Support Packages” for your boards.

As a final test, launch CCSv3 to verify that it runs. For Embedded Coder software to operate with CCSv3, the CCSv3 IDE must be able to run on its own.

Note For a model to work in the targeting environment, select the discrete-time solver in the **Solver** pane of the Simulink Configuration Parameters dialog. Targeting does not work with continuous-time solvers.

To change the discrete-time solver, select **Simulation > Model Configuration Parameters** in the Simulink Editor. In the Configuration Parameters dialog, select the **Solver** pane, and set the **Solver** parameter to **Discrete (no continuous states)**.

Data Type Support

TI C2000 DSPs support 16 and 32-bit data types, but does not have native 8-bit data types. Simulink models and Embedded Coder software support many data types, including 8-bit data types.

If you select `int8` or `uint8` in your model, your simulation runs with 8-bit data, but in the generated code, that data will be represented as 16-bit. This may cause instances where data overflow and wraparound occurs in the simulation, but not in the generated code.

For example, to make the overflow behavior of the simulation and generated code match for a Simulink Add block in your model, select **Saturate on integer overflow** in that block.

Scheduling and Timing

In this section...

“Overview” on page 44-7

“Timer-Based Interrupt Processing” on page 44-7

“Asynchronous Scheduling” on page 44-8

Overview

Normally the code generated by Embedded Coder software runs in the context of a timer interrupt. Model blocks run in a periodical fashion clocked by the periodical interrupt whose period is tied to the base sample time of the model.

This execution scheduling model, however, is not flexible enough for many systems, especially control and communication systems, which must respond to external events in real time. Such systems require the ability to handle various hardware interrupts in an asynchronous fashion.

Embedded Coder software lets you model and generate code for such systems by creating tasks driven by Hardware Interrupt blocks in addition to the tasks that are left to be handled in the context of the timer interrupt.

Timer-Based Interrupt Processing

For code that runs in the context of the timer interrupt, each iteration of the model solver is run after an interrupt has been posted and serviced by an interrupt service routine (ISR). The code generated for the C280x, C281x, and C28x3x uses `CPU_timer0`.

The timer is configured so that the model's base rate sample time corresponds to the interrupt rate. The timer period and prescaler are calculated and set up to produce the desired rate as follows:

$$BaseRateSampleTime = \frac{TimerPeriod}{TimerClockSpeed}$$

The minimum achievable base rate sample time depends on the model complexity. The maximum value depends on the maximum timer period value ($2^{32}-1$ for the F2812, F2808, and F28x35) and the CPU clock speed. The CPU clock speed is 100 MHz for the F2808, and 150 MHz for the F2812 and F28335.

If the blocks in the model inherit their sample time value, and a sample time is not explicitly defined, the default value is 0.2 s.

High-Speed Peripheral Clock

The Event Managers and their general-purpose timers, which drive PWM waveform generation use the high-speed peripheral clock (HISCLK). By default, this clock is selected in Embedded Coder software. This clock is derived from the system clock (SYSCLKOUT):

$$\text{HISCLK} = [\text{SYSCLKOUT} / (\text{high-speed peripheral prescaler})]$$

The high-speed peripheral prescaler is determined by the HSPCLK bits set in SysCtrl. The default value of HSPCLK is 1, which corresponds to a high-speed peripheral prescaler value of 2.

For example, on the F2812, the HISCLK rate becomes

$$\text{HISCLK} = 150 \text{ MHz} / 2 = 75 \text{ MHz}$$

Asynchronous Scheduling

This example shows how to use the c28x peripherals and Hardware Interrupt blocks to control the execution of function-call subsystems in an asynchronous fashion.

Required Hardware:

- Spectrum Digital F2808/F2812/F28335 eZdsp
- Texas Instruments F2808/F28035/F28069/F28335/F28343 ControlCARD with docking station
- Texas Instruments F28069 ControlSTICK
- Oscilloscope and probes

Available versions of this example:

- F281x based board: c281x_asyncscheduling
- F280x/F2823x/F2833x based board: c280x_2833x_asyncscheduling
- Piccolo F2803x/F2806x based board: c280xx_asyncscheduling

Model

The following figure shows the example model.

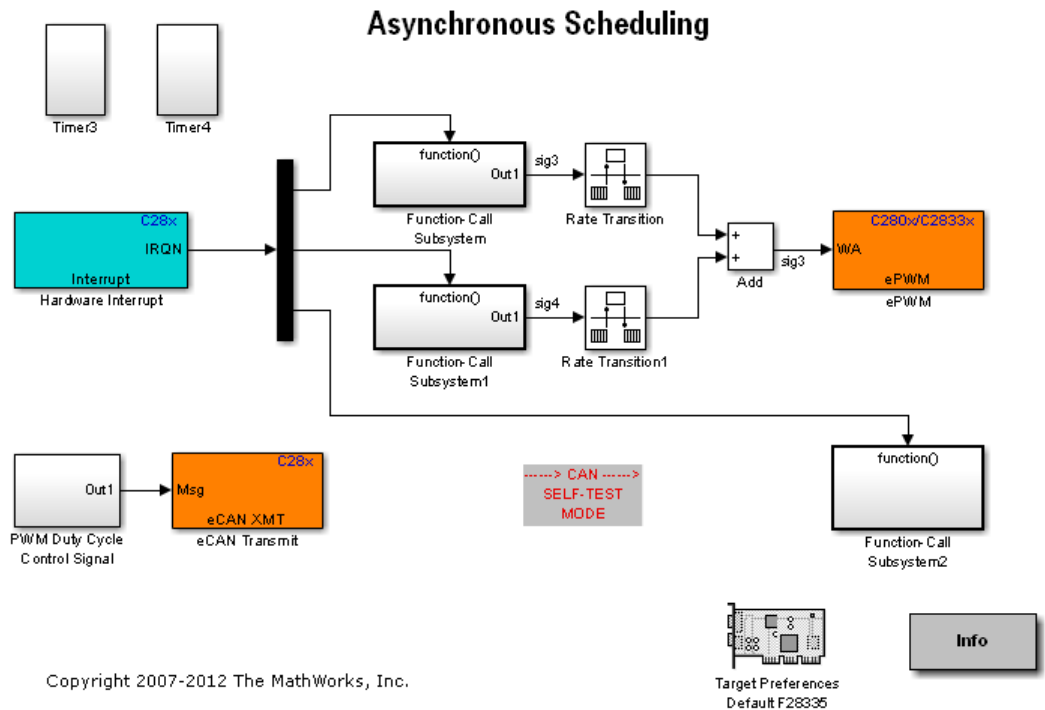

Description

The EV Timer blocks are used to configure timer interrupts to be raised on period match. Hardware Interrupt block installs the ISRs for the timer

interrupts as well as for an eCAN message receive interrupt. The ISRs in turn call function-call subsystems connected to the Hardware Interrupt block output ports.

The outputs of first two subsystems are running counters. Their sum is used to control the duty cycle of the PWMB for F2812 or ePWM2 for F2808/F28335. The PWM waveform duty cycle increases linearly from 0 to 100 %.

The third subsystem contains an eCAN Rcv block whose message output drives a PWM block (PWMA for F2812 or ePWM1 for F2808/F28335) to control its duty cycle. The duty cycle varies from 0 to 100 % as the eCAN messages are received from an eCAN Xmt block.

NOTE: The **Self-Test** mode of eCAN_A is enabled to connect eCAN_A transmitter and receiver internally to avoid external connection between transmitter and receiver. Disabling the **Self-Test** mode for eCAN_A requires transmitter and receiver to be connected together externally.

How to Run the Example on the Board

The following sections explain how to configure, build, and deploy the executable.

With Code Composer Studio v3.3 (CCSv3.3) - Default

- Open the model corresponding to the family of processor you are using.
- Go to **Peripherals > eCAN_A** and check **Self-Test Mode**.
- Click **Incremental build** to generate, build, load and run the program.
- Observe the PWM waveform on the oscilloscope.

With Code Composer Studio v4 (CCSv4)

CCSv4 support is provided via a makefile based approach. This requires running `xmakefilesetup` to set the environment. You can ignore the following if you have already gone through these steps. For more information, please refer to the `Xmakefile Documentation`

- Run `Xmakefile User Configuration`.

- Set the Template parameter to **gmake**.
- Uncheck the **Display operational configuration only** checkbox.
- Set the Configuration parameter to **ticcs_c2000_ccsv4**, click **Apply**, if you haven't used this tool before, a dialog will ask you to browse to your CCSv4 installation folder. Pick the right folder and click **OK**.
- Click on the **Tool Directories** and make sure that the paths are pointing to directories matching your installation. For example:

1 *C:\Program Files\Texas Instruments\ccsv4* for **CCS Installation**

2 *C:\Program Files\Texas Instruments\ccsv4\tools\compiler\C2000* for **Code Generation Tools**

3 *C:\Program Files\Texas Instruments\bios_5_41_10_36* for **DSP/BIOS Installation**

Code Generation and Creation of an .out file using CCSv4:

- Open the model corresponding to the family of processor you are using.
- Open the Coder Target pane. Under the Target Hardware Resources tab, set the **IDE/Tool chain** parameter to Texas Instruments Code Composer Studio v4 (makefile generation only).
- Change the selected board and processor to match your hardware.
- Go to **Peripherals > eCAN_A** and check **Self-Test Mode**.
- Click **Incremental build** or press **Ctrl+B** to generate and build an .out executable file.
- Open CCSv4 and Connect to the Hardware. Load the program on to the Hardware using CCSv4 and run.
- Observe the PWM waveform on the oscilloscope.

With Code Composer Studio v5 (CCSv5)

CCSv5 support is provided via a makefile based approach. This requires running `xmakefilesetup` to set the environment. You can ignore the following if you have already gone through these steps. For more information, please refer to the `Xmakefile Documentation`

- Run XMakefile User Configuration.
- Set the Template parameter to **gmake**.
- Uncheck the **Display operational configuration only** checkbox.
- Set the Configuration parameter to **ticcs_c2000_ccsv5**, click **Apply**, if you haven't used this tool before, a dialog will ask you to browse to your CCSv5 installation folder. Pick the right folder and click **OK**.
- Click on the **Tool Directories** and make sure that the paths are pointing to directories matching your installation. For example:

1 *C:\ti\ccsv5* for **CCS Installation**

2 *C:\ti\ccsv5\tools\compiler\c2000* for **Code Generation Tools**

3 *C:\ti\bios_5_41_11_38* for **DSP/BIOS Installation**

Code Generation and Creation of an .out file using CCSv5:

- Open the model corresponding to the family of processor you are using.
- Open the Coder Target pane. Under the Target Hardware Resources tab, set the **IDE/Tool chain** parameter to Texas Instruments Code Composer Studio v5 (makefile generation only).
- Change the selected board and processor to match your hardware.
- Go to **Peripherals > eCAN_A** and check **Self-Test Mode**.
- Click **Incremental build** or press **Ctrl+B** to generate and build an .out executable file.
- Open CCSv5 and Connect to the Hardware. Load the program on to the Hardware using CCSv5 and run.
- Observe the PWM waveform on the oscilloscope.

Sharing General Purpose Timers between C281x Peripherals

In this section...

“Sharing General Purpose Timers between CAP and eCAN” on page 44-14

“Sharing General Purpose Timers between CAP and SPI” on page 44-18

TMS320x281x DSP devices have four General Purpose (GP) timers. Each Event Manager (EV) module includes two GP timers:

- EVA includes GP Timer 1 and GP Timer 2.
- EVB includes GP Timer 3 and GP Timer 4.

You can use the GP Timers independently or to operate peripherals associated with the EV Manager, such as PWM, QEP, and CAP.

The following table describes the timer-peripheral mapping of the c281xlib block library.

GP Timer Use for C281x Peripheral Blocks

	GP Timer 1	GP Timer 2	GP Timer 3	GP Timer 4
PWM1-PWM6	✓			
PWM7-PWM12			✓	
QEP1-QEP2		✓		
QEP3-QEP4				✓
CAP1-CAP3	✓	✓		
CAP4-CAP6			✓	✓

Each PWM and QEP peripheral has access to only one timer, while each CAP peripheral has access to two timers. In the PWM and QEP blocks, you can set the **Module** option to A or B to determine which unique timer-peripheral combination the block configures. By comparison, in the CAP block, you can use the **Time base** option to select one of two timers for each CAP peripheral.

Each GP timer is available to multiple peripherals. For example:

- PWM1-PWM6 and CAP1-CAP3 share GP Timer 1
- PWM7-PWM12 and CAP4-CAP6 share GP Timer 3
- QEP1-QEP2 and CAP1-CAP3 share GP Timer 2
- QEP3-QEP4 and CAP4-CAP6 share GP Timer 4

The PWM, QEP, CAP, and Timer blocks each provide independent access to key timer registers. If the blocks in your model share a specific GP timer, check that the timer-related settings are compatible. If the peripheral settings for a shared timer are not compatible, the software generates an error when you update the model or generate code.

Sharing General Purpose Timers between CAP and eCAN

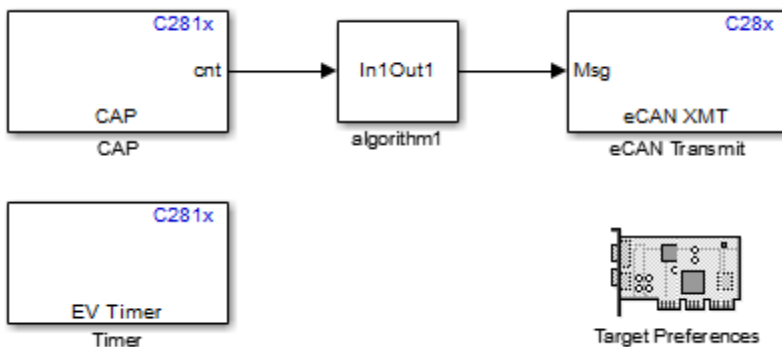

The model contains Timer and CAP blocks that both use Timer 1 (GP Timer 1).

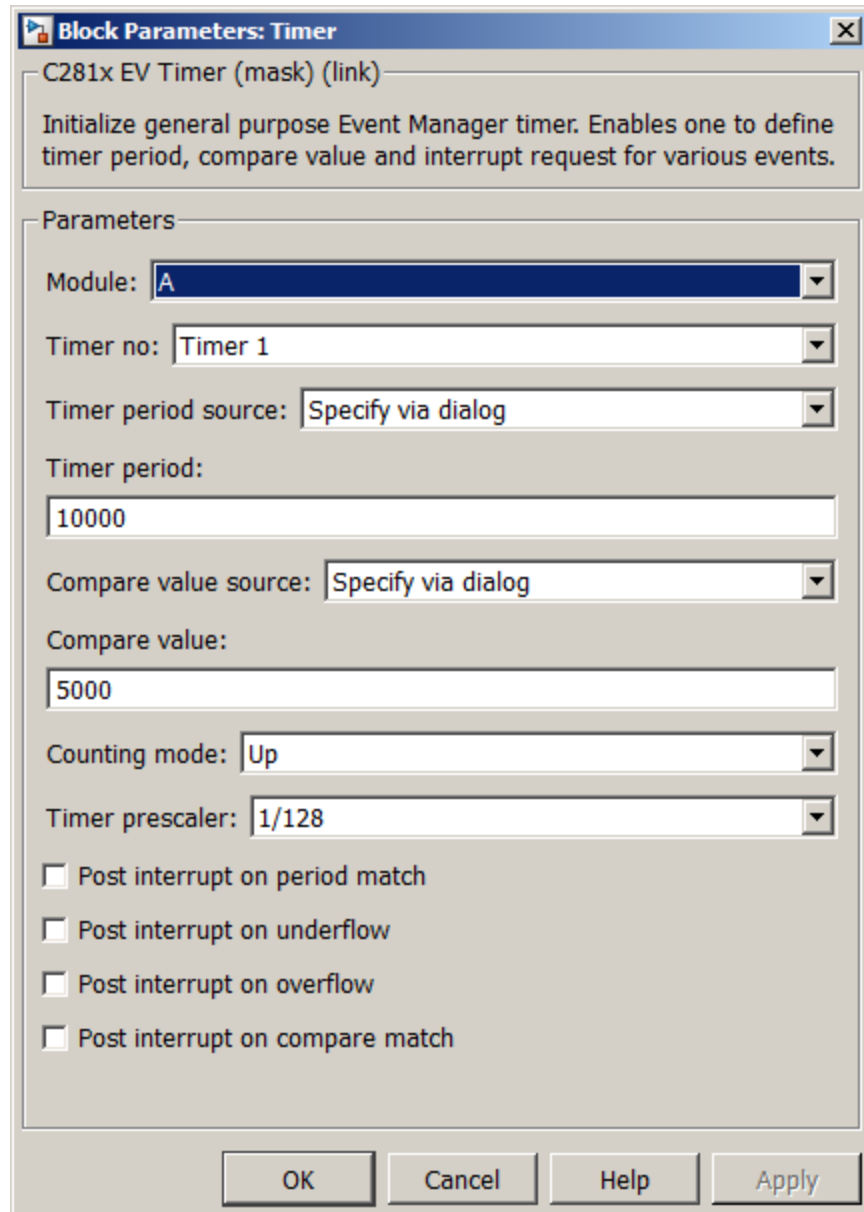

Block Parameters: Timer

C281x EV Timer (mask) (link)

Initialize general purpose Event Manager timer. Enables one to define timer period, compare value and interrupt request for various events.

Parameters

Module: **A**

Timer no: **Timer 1**

Timer period source: **Specify via dialog**

Timer period: **10000**

Compare value source: **Specify via dialog**

Compare value: **5000**

Counting mode: **Up**

Timer prescaler: **1/128**

Post interrupt on period match

Post interrupt on underflow

Post interrupt on overflow

Post interrupt on compare match

OK **Cancel** **Help** **Apply**

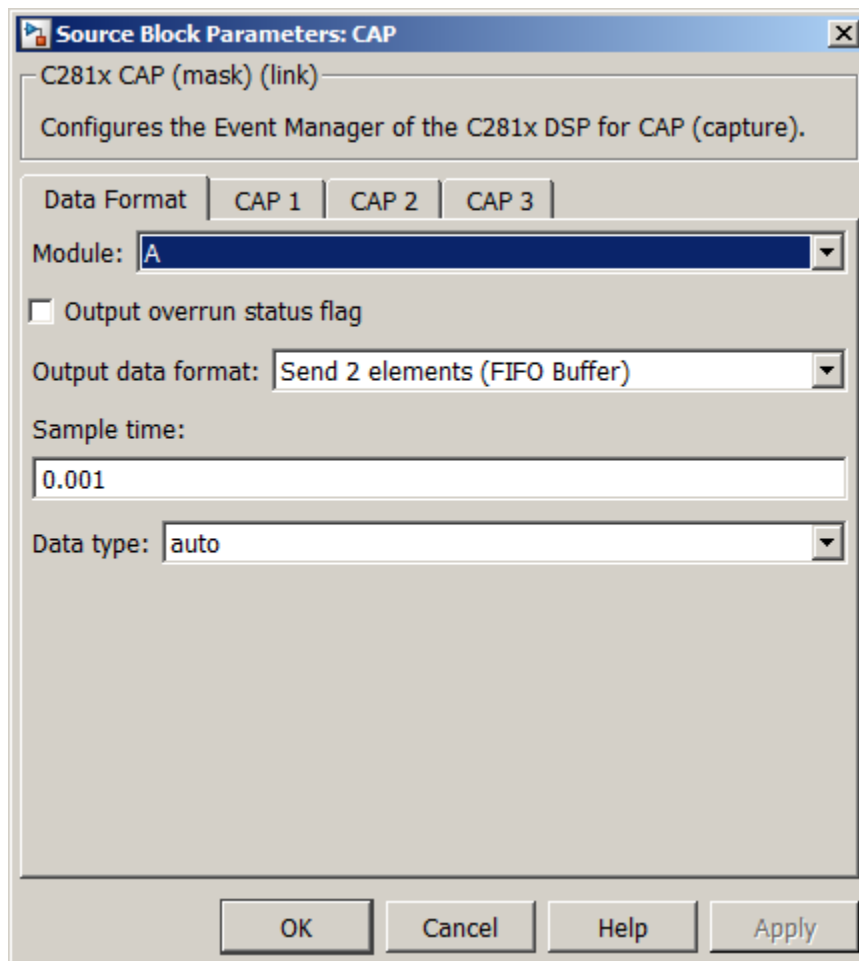

Both blocks have the same values for **Timer prescaler** and **Counting mode**. However, each block has different values for **Timer period**. The value of **Timer period** for Timer 1 is 65535 in the CAP block and 10000 in the Timer block.

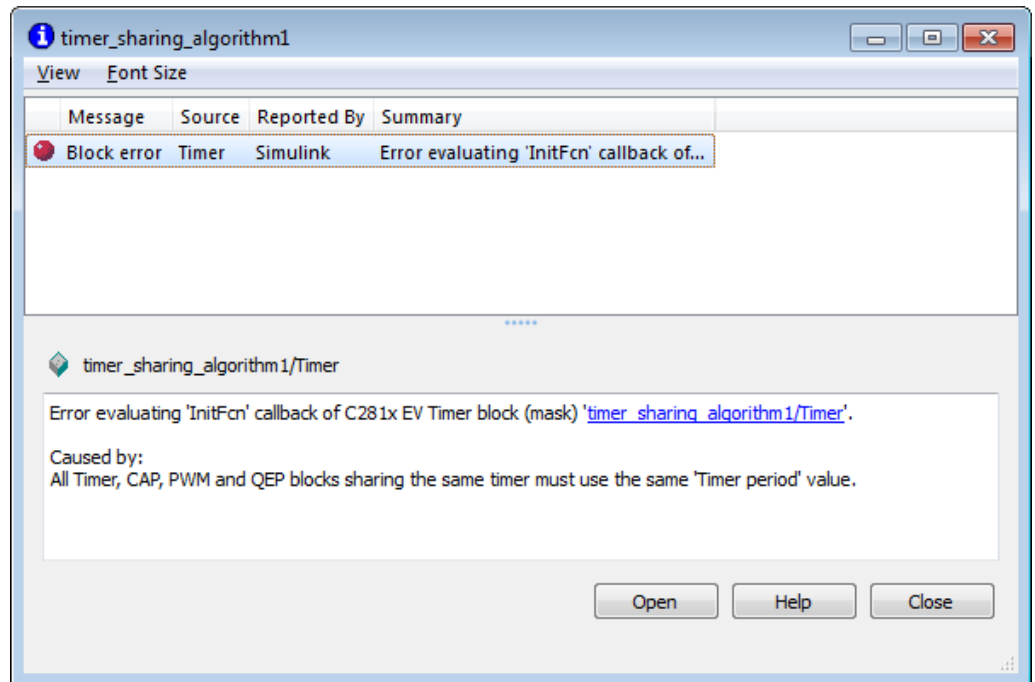

Since both blocks configure the same timer, and settings conflict, the software generates an error when you update the model.

Sharing General Purpose Timers between CAP and SPI

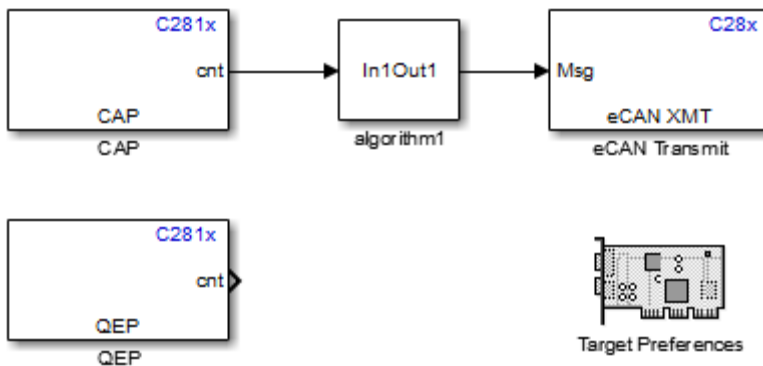

The model contains QEP and CAP blocks that both use Timer 2. In the CAP block, the **Time base** option shows which timer the block uses. In the QEP block, setting **Module** to A configures the block to use QEP1–QEP2. GP Timer Use for C281x Peripheral Blocks on page 44-13 shows that QEP1–QEP2 use Timer 2.

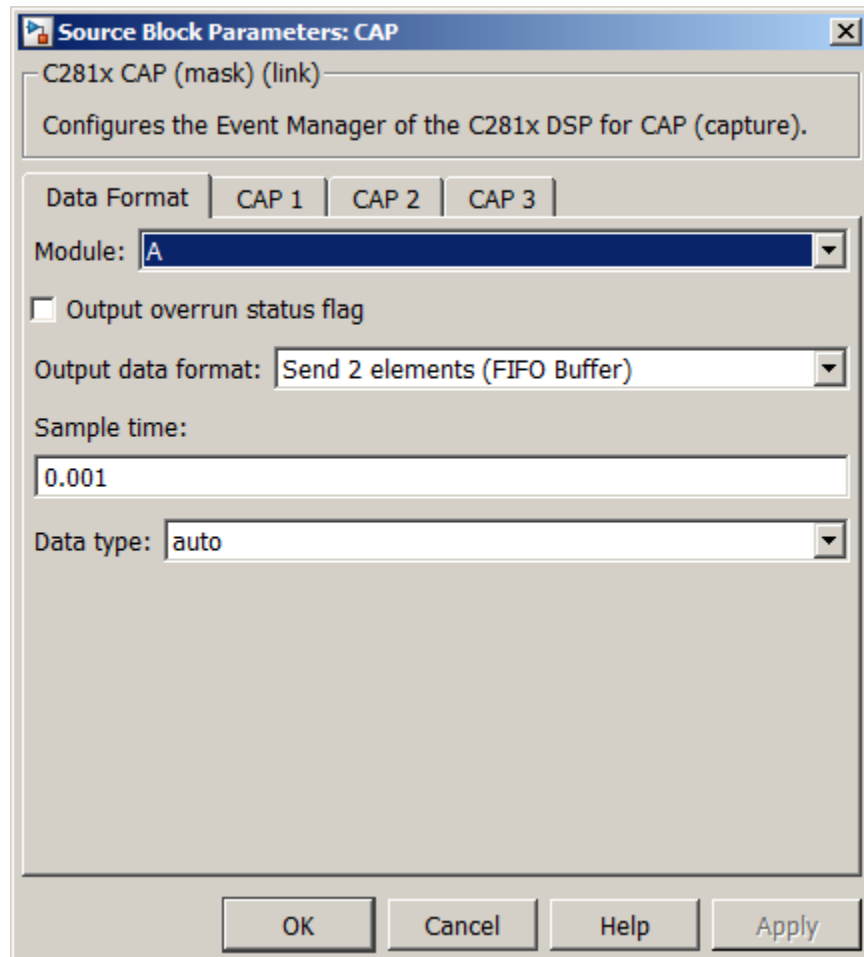

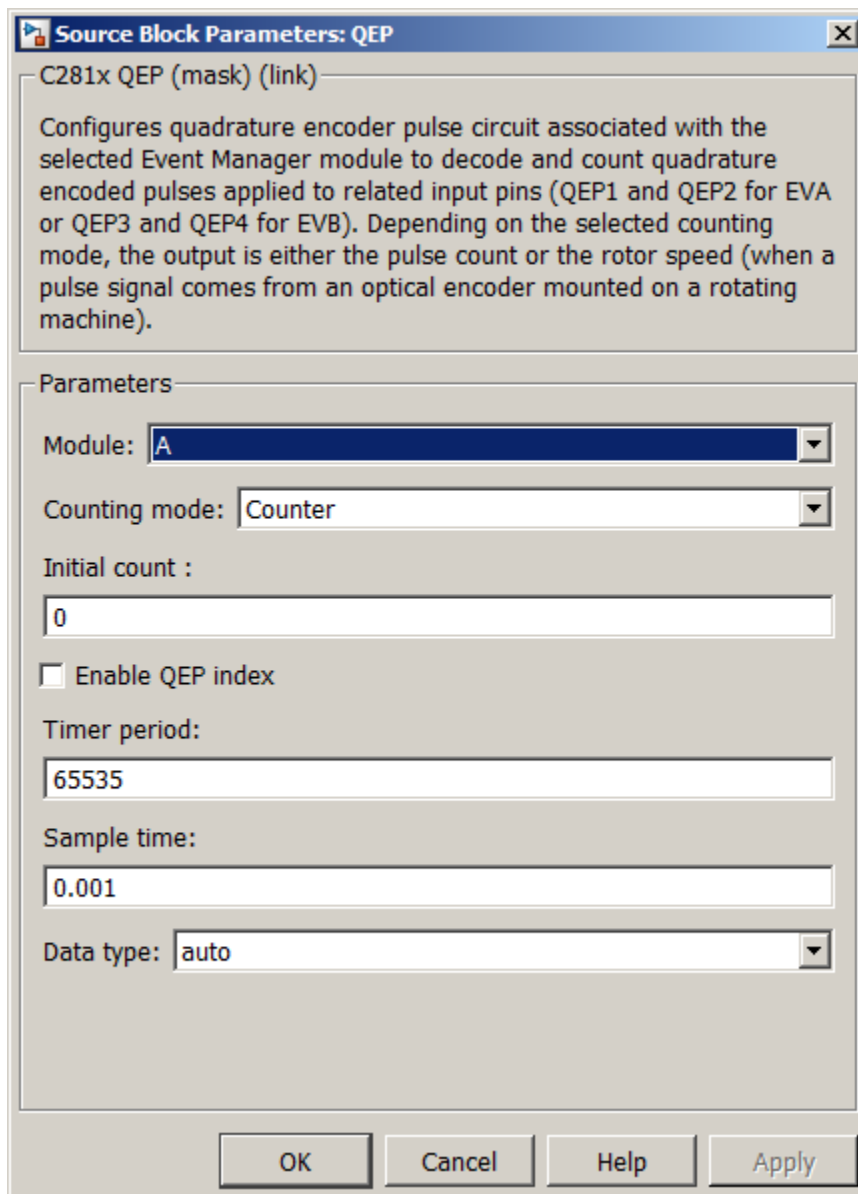

Source Block Parameters: QEP

C281x QEP (mask) (link)

Configures quadrature encoder pulse circuit associated with the selected Event Manager module to decode and count quadrature encoded pulses applied to related input pins (QEP1 and QEP2 for EVA or QEP3 and QEP4 for EVB). Depending on the selected counting mode, the output is either the pulse count or the rotor speed (when a pulse signal comes from an optical encoder mounted on a rotating machine).

Parameters

Module:

Counting mode:

Initial count :

Enable QEP index

Timer period:

Sample time:

Data type:

OK Cancel Help Apply

Currently, both blocks define different clock sources for Timer 2. The CAP block uses `Internal` as a **Clock source**. The QEP block, which does not have a configurable **Clock source** setting, uses the QEP circuit as a clock source. If you build the model, the software generates the following error message.

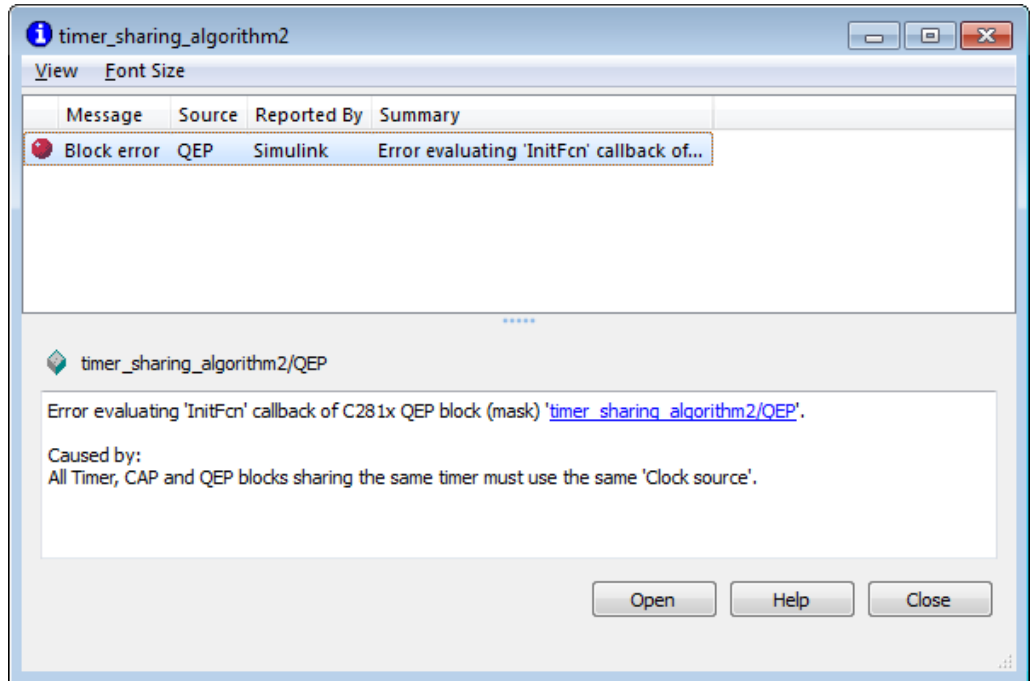

To avoid generating errors when you build the model, change **Clock source** in the CAP block to QEP device.

Overview of Creating Models for C2000 Processors

In this section...

“Accessing the Embedded Coder Block Library” on page 44-22

“Building Your Model” on page 44-22

Accessing the Embedded Coder Block Library

After you have installed the supported development board, start MATLAB.

You can open the `c2000lib` blockset in the Simulink library browser, or by typing the following command at the MATLAB command prompt:

```
c2000lib
```

Create your real-time model for your application the same way you create other Simulink models. Select blocks to build your model from the following sources or products:

- The libraries in the `c2000lib` block library (for handling input and output functions for on your target hardware)
- Simulink Coder software
- Discrete time blocks from Simulink
- Another blockset that meets your needs and operates in the discrete time domain

Building Your Model

With this configuration, you can generate a real-time executable and download it to your TI development board. Simulink Coder software automatically generates C code and inserts the I/O device drivers as specified by the hardware blocks in your block diagram. These device drivers are inserted in the generated C code.

During the same build operation, block parameter dialog entries are combined into a project file for CCS for your TI C2000 board. If you selected the **Build** and **execute build** action in the configuration settings, the TI cross-compiler

builds an executable file. After automatically downloading the executable file to the target, the build process runs the file on the board's DSP.

Note After using the run-time **Build** option to generate and build code for your application, you must perform the following reset sequence before you can run that code on your board. If you want to rerun your application manually once it has been generated, you must also use this procedure.

F2812, F2808, and F28335 eZdsp Reset Sequence

- 1** Reset the board CPU.
- 2** Load your code onto the target hardware.
- 3** Run your code on the target hardware.

Using the c2000lib Blockset

In this section...

“Introduction” on page 44-24

“Hardware Setup” on page 44-24

“Starting the c2000lib Library” on page 44-25

“Setting Up the Model” on page 44-25

“Adding Blocks to the Model” on page 44-26

“Generating Code from the Model” on page 44-28

Introduction

This section uses an example to show how to create a Simulink model that uses Embedded Coder blocks to target your board. The example creates a model that performs PWM duty cycle control via pulse width change. It uses the C2812 ADC block to sample an analog voltage and the C2812 PWM block to generate a pulse waveform. The analog voltage controls the duty cycle of the PWM and you can observe the duty cycle change on the oscilloscope. This model is also provided in the Examples library. The model in the Examples library also includes a model simulation.

Hardware Setup

The following hardware is required for this example:

- Spectrum Digital eZdsp F2812
- Function generator
- Oscilloscope and probes

To connect the hardware:

- 1 Connect the function generator output to the ADC input ADCINA0 on the eZdsp F2812.
- 2 Connect the output of PWM1 on the eZdsp F2812 to the analog input of the oscilloscope.

- 3 Connect VREFLO to AGND on the eZdsp F2812. See the section on the Analog Interface in Chapter 2 of the *eZdsp™ F2812 Technical Reference*, available from the Spectrum Digital Web site at <http://c2000.spectrumdigital.com/ezf2812/>

Starting the c2000lib Library

At the MATLAB prompt, type the following command:

```
c2000lib
```

This command opens the c2000lib library blockset, which contains libraries of blocks designed for targeting your board.

Setting Up the Model

Preliminary tasks for setting up a new model include configuring the Target Hardware Resources tab and setting the simulation parameters.

- 1 Configure the Target Hardware Resources tab, as described in “Configure Target Hardware Resources” on page 35-3.
- 2 The following settings are made, referenced in the table below by their locations in the **Simulation > Model Configuration Parameters** dialog:

Pane	Field	Setting
Solver	Stop time	10
Solver	Type	Fixed-step
Data Import/Export	Save to workspace - Time	tout
Data Import/Export	Save to workspace - Output	yout
Hardware Implementation	Device type	C2000
Code Generation	Target selection - System target file	idelink_grt.tlc or idelink_ert.tlc

Note Generated code does not honor Simulink stop time from the simulation. Stop time is interpreted as `inf`. To implement a stop in generated code, you must put a Stop Simulation block in your model.

- 3** From your model's main menu, select **Simulation > Model Configuration Parameters** to verify and set the simulation parameters for this model. Parameters you set in this dialog belong to the model you are building. They are saved with the model and stored in the model file. Refer to your Simulink documentation for information on the Configuration Parameters dialog.
- 4** Use the **Code Generation** pane to set options for the real-time model.
- 5** Use the **Browse** button to locate and select a target configuration file, `idmlink_grt.tlc` or `idmlink_ert.tlc`. When you do this, your coder product chooses the system target file, and make command.
- 6** Set the Configuration Parameters by typing **Ctrl-E** and adjust these parameters.

Adding Blocks to the Model

- 1** Open or double-click the C281x library, `c281x.lib`.
- 2** Drag the ADC block into your model. Double-click the ADC block in the model and set **Sample time** to `64/80000`.
- 3** Drag the PWM block into your model. Double-click the PWM block in the model and set the following parameters.

Pane	Field	Parameter
Timer	Module	A
	Waveform period source	Specify via dialog
	Waveform period units	Clock cycles
	Waveform period	64000
	Waveform type	Asymmetric
Outputs	Enable PWM1/PWM2	Selected
	Duty cycle source	Input port
Logic	PWM1 control logic	Active high
	PWM2 control logic	Active low
Deadband	Use deadband for PWM1/PWM2	Selected
	Deadband prescaler	16
	Deadband period	12
ADC Control	ADC start event	Period interrupt

- 4** Enter Simulink in the MATLAB Command Window to open the Simulink Library browser. Drag a Gain block from the Math Operations library into your model. Double-click the Gain block in the model and set the following parameters in the Function Block Parameters dialog. Click **OK**.

Pane	Field	Parameter
Main	Gain	30
	Multiplication	Element-wise (K.*u)
	Sample time	-1
Signal Attributes	Output data type mode	uint(16)
	Integer rounding mode	Floor
Parameter Attributes	Parameter data type mode	Inherit from input mode

- 5 Connect the ADC block to the Gain block and the Gain block to the PWM block.

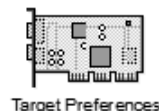
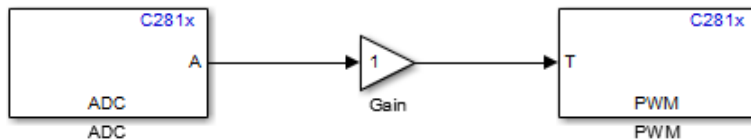

Generating Code from the Model

This section summarizes how to generate code from your real-time model.

There are three ways to start the automatic code generation process:

- In the Simulink Editor, click **Build Model** .
- With your model open and in focus, press **Ctrl+b**.

- Press the Build button located on the **Code Generation** pane of the Configuration Parameters dialog.

Note In CCSv3, you see your project with the files in place in the folder structure.

Configuring Timing Parameters for CAN Blocks

In this section...

“The CAN Blocks” on page 44-30

“Setting Timing Parameters” on page 44-30

“Parameter Tuning and Signal Logging” on page 44-36

The CAN Blocks

The bit rate of these four CAN blocks cannot be set directly:

C281x eCAN Receive

C281x eCAN Transmit

C280x/C28x3x eCAN Receive

C280x/C28x3x eCAN Transmit

Setting Timing Parameters

- “Accessing the Timing Parameters” on page 44-30
- “Determining Timing Parameter Values” on page 44-33
- “Working with CAN Bit Timing” on page 44-34

Accessing the Timing Parameters

To set the Bitrate for a block whose bitrate cannot be set directly:

- 1 Configure the Target Hardware Resources tab, as described in “Configure Target Hardware Resources” on page 35-3.
- 2 Under the **Peripherals** tab, use the **TSEG1**, **TSEG2**, and **BaudRatePrescaler (BRP)** parameters to set the bitrate.

For example, the Target Hardware Resources tab for the F2812 eZdsp, this dialog is shown in the following figure.

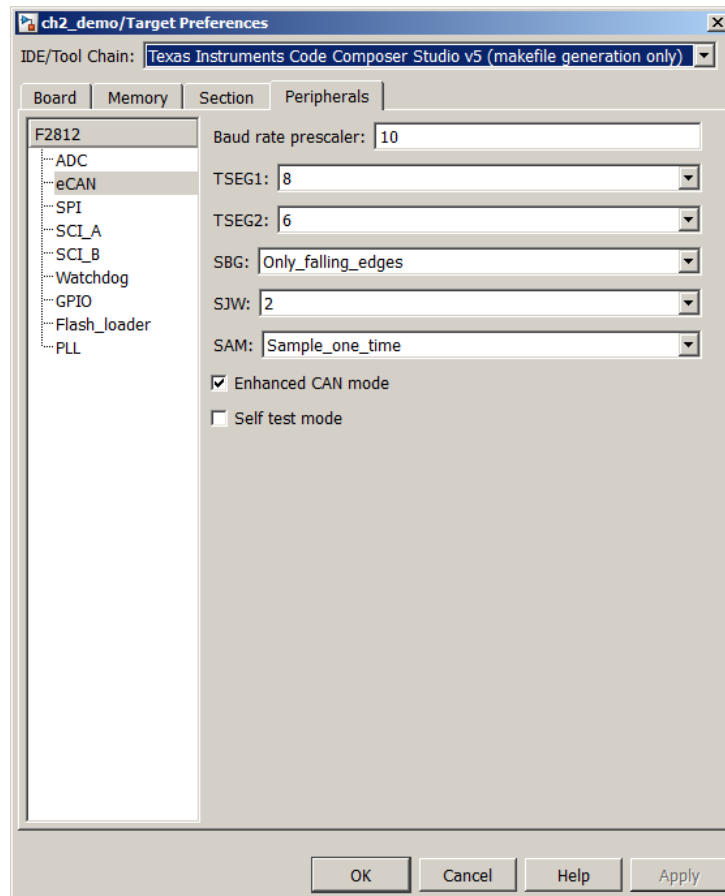

The C280x/C28x3x blocks have two independent eCAN modules.

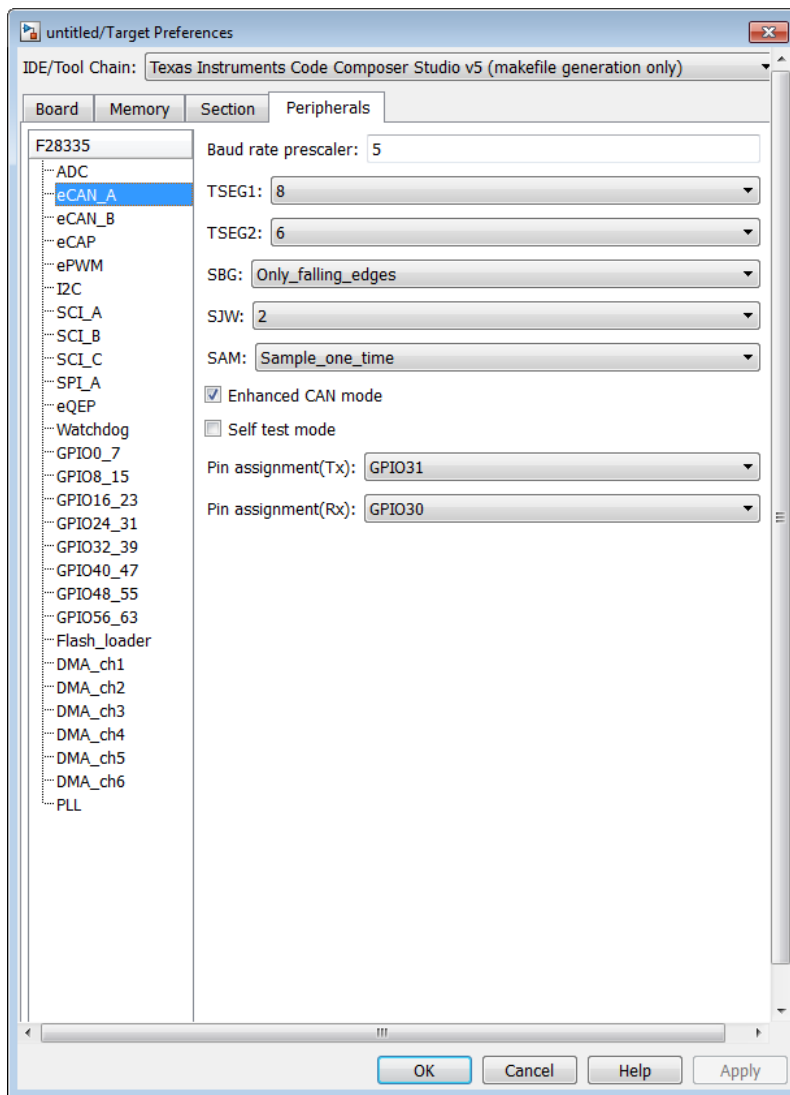

The following sections describe the series of steps and rules that govern the process of setting these timing parameters.

Determining Timing Parameter Values

To determine the values for the timing parameters, complete the following steps:

- 1 Determine the CAN Bitrate specification based on your application.
- 2 Determine the frequency of the **CAN module clock**. For example:
 - CAN module clock = 100 MHz for the F2808 (Same as SYSCLKOUT)
 - CAN module clock = 150 MHz for the F2812 (Same as SYSCLKOUT)
 - CAN module clock = 75 MHz for the F28x3x (150 SYSCLKOUT/2)

3 Estimate the value of the **BaudRatePrescaler (BRP)**.

4 Solve this equation for BitTime:

$$\text{BitTime} = \text{CAN module clock frequency} / (\text{BRP} * \text{Bitrate})$$

5 Solve this equation for Bitrate:

$$\text{Bitrate} = \text{CAN module clock frequency} / (\text{BRP} * \text{BitTime})$$

6 Estimate values for **TSEG1** and **TSEG2** that satisfy $\text{BitTime} = \text{TSEG1} + \text{TSEG2} + 1$.

7 Use the following rules to determine the values of **TSEG1** and **TSEG2**:

$$\text{TSEG1} \geq \text{TSEG2}$$

$$\text{IPT (Information Processing Time)} = 3/\text{BRP}$$

$$\text{IPT} \leq \text{TSEG1} \leq 16 \text{ TQ}$$

$$\text{IPT} \leq \text{TSEG2} \leq 8 \text{ TQ}$$

$$1 \text{ TQ} \leq \text{SJW} \leq \min(4 \text{ TQ}, \text{TSEG2})$$

where IPT is Information Processing Time, TQ is Time Quanta, and SJW is Synchronization Jump Width, also set in the Target Hardware Resources dialog.

8 Iterate steps 4 through 7 until the values selected for TSEG1, TSEG2, and BRP meet the criteria.

The following illustration shows the relationship between the eCAN bit timing parameters.

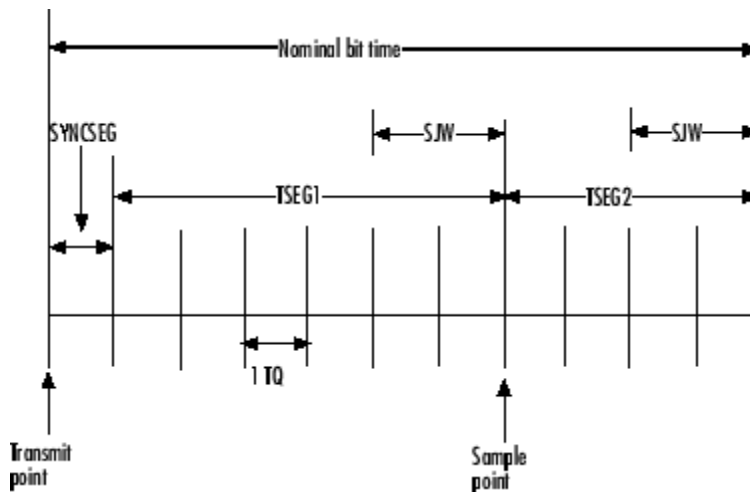

Working with CAN Bit Timing

Assume that CAN Module Clock Frequency = 75 MHz, and a Bitrate of 1 Mbits/s is required.

- 1 Set the BRP to 5. Then substitute the values of CAN Module Clock Frequency, BRP, and Bitrate into the following equation, solving for BitTime:

$$\text{BitTime} = \text{CAN Module Clock Frequency} / (\text{BRP} * \text{Bitrate})$$

$$\text{BitTime} = 75\text{e}6 / (5 * 1\text{e}6) = 15\text{TQ}$$

- 2 Set the values of TSEG1 and TSEG2 to 8TQ and 6TQ respectively. Substitute the values of *BitTime* from the previous equation, and the chosen values for TSEG1 and TSEG2 into the following equation:

$$\text{BitTime} = \text{TSEG1} + \text{TSEG2} + 1$$

$$15\text{TQ} = 8\text{TQ} + 6\text{TQ} + 1$$

- 3 Finally, check the selected values against the rules:

$$IPT = 3/BRP = 3/10 = .3$$

$$IPT \leq TSEG1 \leq 16 TQ \text{ True! } .3 \leq 8TQ \leq 16TQ$$

$$IPT \leq TSEG2 \leq 8TQ \text{ True! } .3 \leq 6TQ \leq 8TQ$$

$1TQ \leq SJW \leq \min(4TQ, TSEG2)$ which means that **SJW** can be set to either 2, 3, or 4

- 4** When the chosen values satisfy the criteria, so further iteration is not required.

The following table provides example values for several bit rates when CAN Module Clock Frequency = 75 MHz, as it is with the F28335. Other combinations of the register values are possible.

Bitrate	TSEG1	TSEG2	Bit Time	BRP	SJW
0.25 Mbit/s	8	6	15	20	2
0.5 Mbit/s	8	6	15	10	2
1 Mbit/s	8	6	15	5	2

The following table provides example values for several bit rates when CAN Module Clock Frequency = 100 MHz, as it is with the F2808. Other combinations of the register values are possible.

Bitrate	TSEG1	TSEG2	Bit Time	BRP	SJW
0.25 Mbit/s	6	3	10	40	2
0.5 Mbit/s	5	4	10	20	2
1 Mbit/s	6	3	10	10	2

The following table provides example values for several bit rates when CAN Module Clock Frequency = 150 MHz, as it is with the F2812. Other combinations of the register values are possible.

Bitrate	TSEG1	TSEG2	Bit Time	BRP	SJW
0.25 Mbit/s	8	6	10	40	2
0.5 Mbit/s	7	7	10	20	2
1 Mbit/s	8	6	10	10	2

Parameter Tuning and Signal Logging

- “Overview” on page 44-36
- “Using External Mode” on page 44-36
- “Using a Third Party Calibration Tool” on page 44-46

Overview

Embedded Coder software supports parameter tuning and signal logging either using Simulink External mode or with a third party calibration tool. In both cases the model must include a CAN Calibration Protocol block.

Using External Mode

The Simulink External mode feature enables you to log signals and tune parameters without requiring a calibration tool. This section describes the steps for converting a model to use External mode.

External mode is supported using the CAN Calibration Protocol block and ASAP2 interface. The CAN Calibration Protocol block is used to communicate with the target, download parameter updates, and upload signal information. The ASAP2 interface is used to get information about where in the target memory a parameter or signal lives.

Note You must configure the host-side CAN application channel. See “Configuring the Host Vector CAN Application Channel” on page 44-38.

To prepare your model for External mode, follow these steps:

- 1** Add a CCP driver block.
- 2** Identify signals you want to tune, and associate them with `Simulink.Parameter` or `canlib.Parameter` objects with `ExportedGlobal` storage class. It is important to set the data type and value of the object. See “Using Supported Objects and Data Types” on page 44-39.
- 3** Identify signals you want to log, and associate them with `canlib.Signal` objects. It is important to set the data type of the `canlib.Signal`. See “Using Supported Objects and Data Types” on page 44-39.

For information about visualizing logged signal data, see “Viewing and Storing Signal Data” on page 44-41.
- 4** Load the `Simulink.Parameter` or `canlib.Parameter` and `canlib.Signal` data objects into the base workspace.
- 5** Configure the model for building, as described in “Manual Configuration For External Mode” on page 44-44.
- 6** Build the model, and download the executable to the target
- 7** After downloading the executable to the target, you can switch the model to External mode, as described in “Manual Configuration For External Mode” on page 44-44.
- 8** You can now connect to the target using External mode by clicking the **Connect** button.
- 9** If you have set up tunable parameters, you can now tune them. See “Tuning Parameters” on page 44-40.

See the following topics for more information:

- “Configuring the Host Vector CAN Application Channel” on page 44-38
- “Using Supported Objects and Data Types” on page 44-39
- “Tuning Parameters” on page 44-40
- “Viewing and Storing Signal Data” on page 44-41
- “Manual Configuration For External Mode” on page 44-44

- “Limitations” on page 44-45

Configuring the Host Vector CAN Application Channel. External mode expects that the host-side CAN connection is using the 'MATLAB 1' application channel. To configure the application channel used by the Vector CAN drivers, enter the following in the MATLAB Command Window:

```
TargetsComms_VectorApplicationChannel.configureApplicationChannels
```

The Vector CAN Configuration tool appears. Use this tool to configure your host-side CAN channel settings.

If you try to connect using an application channel other than 'MATLAB 1', then you see the following warning in the command window:

Warning:

```
It was not possible to connect to the target using CCP.  
An error occurred when issuing the CONNECT command.
```

If you have not already installed the Vector CAN drivers, you will get the following error message:

```
??? Error using ==>  
TargetsComms_VectorApplicationChannel.TargetsComms_VectorApplicationChannel>  
TargetsComms_VectorApplicationChannel.configureApplicationChannels at 40  
Unable to launch the application channel configuration utility.  
The "vcanconf" utility was not found on the Windows System Path.  
To fix this error, make sure the required CAN drivers are installed on this computer;  
refer to the product documentation for details.
```

If you want to use CAN to transmit or receive CAN messages between your host PC and your target, you require Vector-Informatik CAN hardware supported by the Vector CAN Driver Library. Choose the driver libraries to support profiling, downloading, and External mode.

Note For CANcaseXL, install *both* the Vector XL-driver library and Vector CAN Driver Library `vcand32.dll`.

For older CAN hardware, you must install the Vector CAN Driver Library `vcand32.dll`.

Make sure that the library, `vcand32.dll`, is placed in the Windows `system32` folder.

Using Supported Objects and Data Types. Supported objects:

- `Simulink.Parameter` or `canlib.Parameter` for parameter tuning
- `canlib.Signal` for signal logging

Supported data types:

- `uint8`, `int8`
- `uint16`, `int16`
- `uint32`, `int32`
- `single`

You need to define data objects for the signals and parameters of interest for ASAP 2 file generation. For ease of use, create a MATLAB file to define the data objects, so that you only have to set up the objects once.

To set up tunable parameters and signal logging:

- 1 Associate the parameters to be tuned with `Simulink.Parameter` or `canlib.Parameter` objects with `ExportedGlobal` storage class. It is important to set the data type and value of the parameter object. See the following code for an example of how to create such a `Simulink.Parameter` object for tuning:

```
stepSize = Simulink.Parameter;  
stepSize.DataType = 'uint8';  
stepSize.CoderInfo.StorageClass = 'ExportedGlobal';
```

```
stepSize.Value = 1;
```

- 2** Associate the signals to be logged with `canlib.Signal` objects. It is important to set the data type of the `canlib.Signal`. The following code example shows how to declare such a `canlib.Signal` object for logging:

```
counter = canlib.Signal;  
counter.DataType = 'uint8';
```

- 3** Associate the data objects you defined in the MATLAB file with parameters or signals in the model. For the previous code examples, you could set the **Constant value** in a Source block to `stepSize`, and set a **Signal name** to `counter` in the Signal Properties dialog. Remember that `stepSize` and `counter` are data objects defined in the code.

Tuning Parameters. To tune a parameter, follow these steps:

- 1** Set `dataobject.value` in the workspace while the model is running in External mode. For example, to tune the parameter `stepSize` (that is, to change its value) from 1 to 2, enter the following at the command line:

```
stepSize.value = 2
```

You see output similar to the following:

```
stepSize =  
  
Simulink.Parameter (handle)  
  CoderInfo: [1x1 Simulink.ParamCoderInfo]  
  Description: ''  
  DataType: 'uint8'  
  Min: []  
  Max: []  
  DocUnits: ''  
  Value: 2  
  Complexity: 'real'  
  Dimensions: [1 1]
```

- 2 Return to your model, and update the model (press **Ctrl+D**) to apply the changed parameter.

Viewing and Storing Signal Data. To view the logged signals, attach a supported scope type to the signal (see “Limitations” on page 44-45 for supported scope types).

By default, data from each scope is logged.

To customize which signals are logged:

- 1 In the Simulink Editor, select **Code > External Mode Control Panel**.
- 2 In External Mode Control Panel, click the **Signal & Triggering** button.
- 3 In External Signal & Triggering, clear the check boxes for scope data you do not want to log.

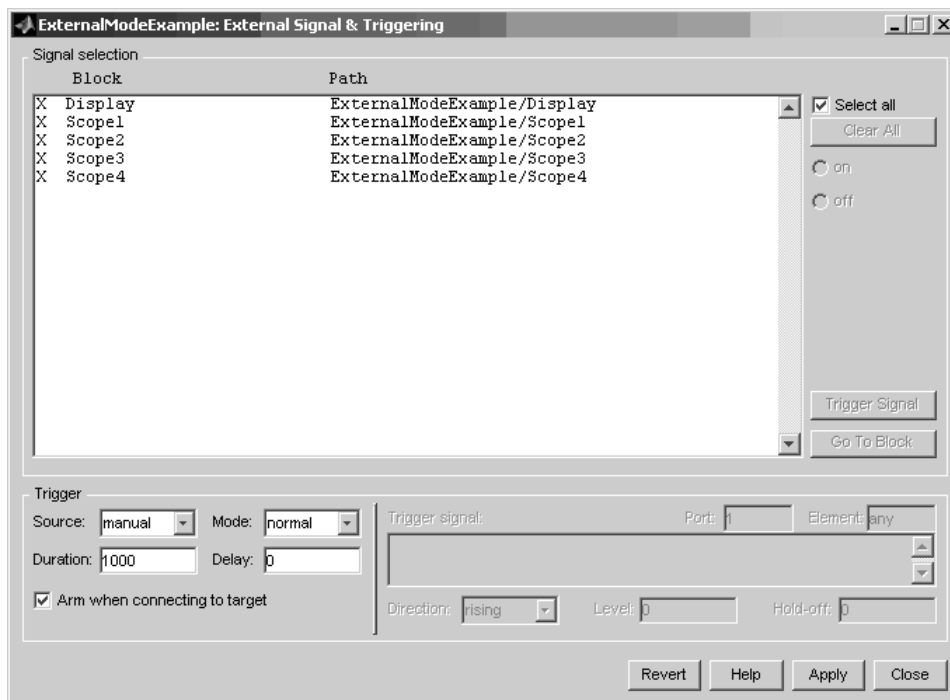

Storing signal data for further analysis. It is possible to store the logged data for further analysis in MATLAB.

- 1 To use the Data Archiving feature of External mode, click **Data Archiving** in the External Mode Control Panel. The External Data Archiving dialog appears.

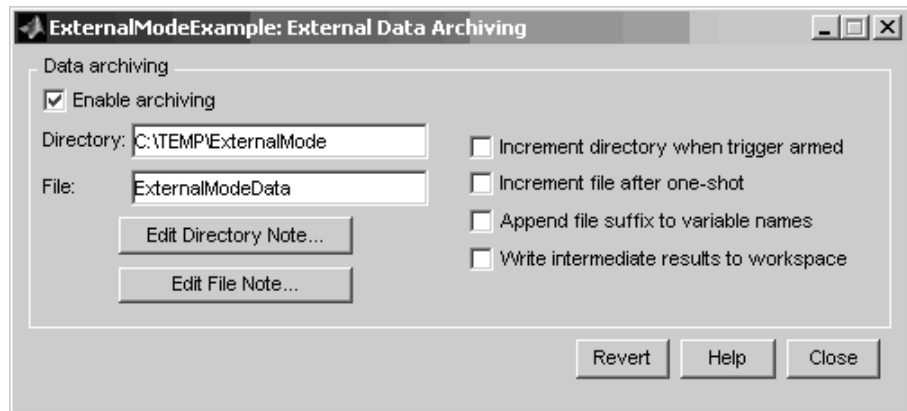

- a Select the check box **Enable archiving**
 - b Edit the **Folder** and **Filename** and review the other settings.
 - c Close the dialog.
- 2 Open the Scope parameters, and select the check box **Save data to workspace**.

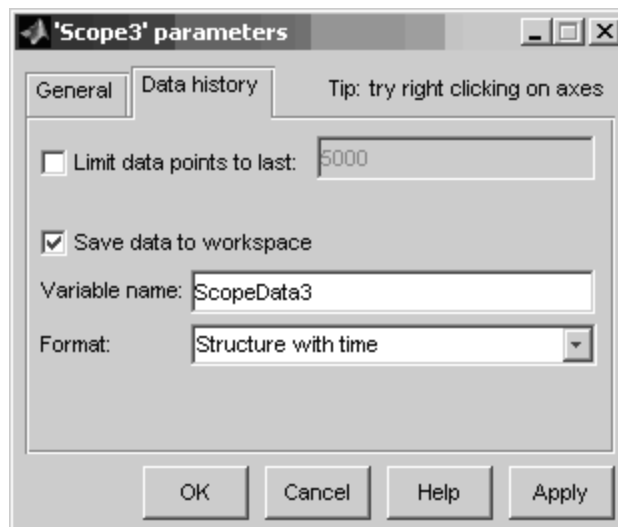

- 3** You may want to edit the **Variable name** in the edit box. The data that is displayed on the scope at the end of the External mode session is available in the workspace with this variable name.

The data that was previously displayed in the scope is stored in .mat files as previously setup using Data Archiving.

For example, at the end of an External mode session, the following variable and files could be available in the workspace and current folder:

- A variable ScopeData5 with the data currently displayed on the scope:

```
ScopeData5

ScopeData5 =

        time: [56x1 double]
       signals: [1x1 struct]
   blockName: 'mpc755rt_ccp/Scope1'
```

- In the current folder, .mat files for the three previous **Durations** of scope data:

```
ExternalMode_0.mat
ExternalMode_2.mat
ExternalMode_1.mat
```

Manual Configuration For External Mode. You can configure models manually for build and execution with External mode.

To configure a model to be built for External mode:

- 1** Select **Simulation > Model Configuration Parameters**.
- 2** In the Configuration Parameters dialog, open the **Optimization > Signals and Parameters** pane.
- 3** Select the **Inline parameters** check box and click the **Configure** button.
- 4** In the Model Parameter Configuration dialog that opens, define the (global) tunable parameters for your models.

- 5** Select **Simulation > Mode > Normal**. Or, set Simulation mode as shown here.



- 6** In the Configuration Parameters dialog, open the **Code Generation > Interface** pane.

- 7** Set the **Interface** parameter to ASAP2.

After you build the model, you can configure it for External mode execution:

- 1** Select **Simulation > Mode > External**.

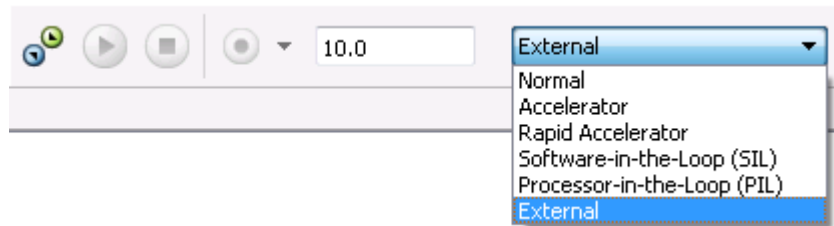

- 2** In the Configuration Parameters dialog, open the **Code Generation > Interface** pane.

- 3** Set the **Interface** parameter to External mode.

Limitations. Multiple signal sinks (e.g. scopes) are not supported.

Only the following kinds of scopes are supported with External mode Logging:

- Simulink Scope block
- Simulink Display block

- Viewer type: scope — To use this option, right-click a signal in the model, and select **Create & Connect Viewer > Simulink > Scope**. The other scope types listed there are not supported (e.g., floating scope).

Before connecting to External mode, you also need to right-click the signal, and select **Signal Properties**. In the dialog, select the **Test point** check box, and click **OK**.

GRT is supported but only for parameter tuning.

It is not possible to log signals with sample rates in excess of 10 kHz.

Subsystem builds are not supported for External mode, only top-level builds are supported.

Logging and tuning of nonscalars is not supported. It is possible to log nonscalar signals by breaking the signal down into its scalar components. For an example of how to do this signal deconstruction, see the CCP example models, which use a Demux and Signal Conversion block with contiguous copy.

Logging and tuning of complex numbers is not supported. It is possible to work with complex numbers by breaking the complex number down into its real and imaginary components. This breakdown can be performed using the following blocks in the Simulink Math Operations library: Complex to Real-Imag, Real-Imag to Complex, Magnitude-Angle to Complex, Complex to Magnitude-Angle.

Using a Third Party Calibration Tool

Embedded Coder allows an ASAP2 data definition file to be generated during the code generation process. This file can be used by a third party tool to access data from the real-time application while it is executing.

ASAP2 is a data definition standard by the Association for Standardization of Automation and Measuring Systems (ASAM). ASAP2 is a standard description for data measurement, calibration, and diagnostic systems. Embedded Coder software lets you export an ASAP2 file containing information about your model during the code generation process.

Before you begin generating ASAP2 files with Embedded Coder software, see “Generating an ASAP2 File” in the product help for Simulink Coder. That

section describes how to define the signal and parameter information required by the ASAP2 file generation process.

Select the ASAP2 option before the build process as follows:

1 Select **Simulation > Model Configuration Parameters**.

The Configuration Parameters dialog appears.

2 Select the Code Generation > Interface pane.

3 Select the ASAP2 option from the **Interface** drop-down menu, in the **Data exchange** frame.

4 Click **Apply**.

The build process creates an ASAM-compliant ASAP2 data definition file for the generated C code.

- The standard ASAP2 file generation does not include the memory address attributes in the generated file. Instead, it leaves a placeholder that must be replaced with the actual address by postprocessing the generated file.
- The map file options in the template project need to be set up a certain way for this procedure to work. If you have created your own template projects, and you do not have the right settings, you see the following instructions:

Warning: It was not possible to do ASAP2 processing on your .map file. This is because your IDE project template is not configured to generate a .map file in the correct format. To generate a .map file in the correct format you need to setup the following options in your IDE project template:

- Generate section map should be checked on
- Generate register map should be checked off
- Generate symbol table should be checked on
- Format list file into pages should be checked off
- Generate summary should be checked off
- Page width should be equal to 132 characters
- Symbol columns should be 1

You can change these options via Project -> Project Options
-> Linker/Locator -> Map File -> Map File Format.

Embedded Coder software performs this postprocessing for you. To do this, it first extracts the memory address information from the map file generated during the link process. Secondly, it replaces the placeholders in the ASAP2 file with the actual memory addresses. This postprocessing is performed automatically and does not require additional input from you.

ADC-PWM Synchronization via ADC Interrupt

This example shows how to use the ADC and PWM blocks. In the generated code, changes in the voltage of the ADC input alter the duty cycle of the PWM output. The period of the PWM waveform remains constant. This example also shows how to use the Hardware Interrupt block to synchronize the update of the PWM duty cycle with the ADC conversion.

Required Hardware:

- Spectrum Digital F2808/F2812/F28335 eZdsp
- Texas Instruments
F2808/F28027/F28035/F28044/F28069/F28335/F28343/F28346
ControlCARD with docking station
- Texas Instruments F28027/F28069 ControlSTICK
- Oscilloscope and probes
- Function generator

The following models are available for this example:

- F281x based board: `c281x_adcpwmasynctest`
- F280x/F2823x/F2833x based board: `c280x_2833x_adcpwmasynctest`
- Piccolo F2802x/F2803x/F2806x based board: `c280xx_adcpwmasynctest`

To open the model, enter the model name in the MATLAB Command Window.

The following figure shows the example model.

ADC-PWM Synchronization via ADC Interrupt

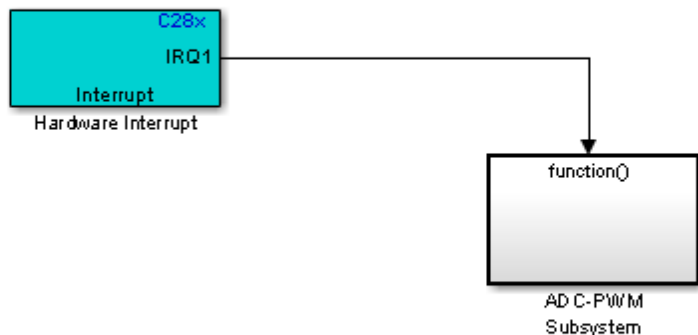

Copyright 2007-2012 The MathWorks, Inc.

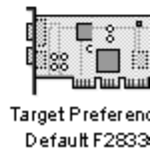

This model shows how to use the ADC block to sample an analog voltage and how to use the PWM block to generate a pulse waveform. The analog voltage controls the duty cycle of the PWM waveform. Duty cycle changes can be observed on the oscilloscope. "Hardware Interrupt" installs an Interrupt Service Routine (ISR) for ADC interrupt and schedules the execution of the connected subsystem (ADC-PWM Subsystem) when ADC interrupt (ADCINT) is received.

"ADC-PWM Subsystem" consists of an ADC driving the duty cycle input port of the PWM. PWM is configured to trigger ADC start of conversion (SOC).

Before using the model, connect the function generator output to the ADC input ADCINA0 on the board. Connect the output of the PWM1 to the analog input of the oscilloscope.

Run the model using CCSv3

- Open the model corresponding to the family of processor you are using.
- Each model is configured for a default processor. Open the Target Hardware Resources tab to select a different processor.
- Click **Incremental build** or press **Ctrl+b** to generate, build, load and run the program.
- Observe the change of the PWM waveform on the oscilloscope.

Run the model using CCSv4

CCSv4 support is provided via a makefile based approach. This requires running `xmakefilesetup` to set the environment. You can ignore the following if you have already gone through these steps. For more information, see “Using Makefiles with Code Composer Studio 4 & 5” on page 43-4.

- Enter `xmakefilesetup` in a MATLAB Command Window.
- In the XMakefile User Configuration dialog that opens, set the **Template** parameter to `gmake`.
- Clear the **Display operational configuration only** check box.
- Set the **Configuration** parameter to `ticcs_c2000_ccsv4`, click **Apply**.
- If you haven't used this configuration before, a dialog will ask you to browse to your CCSv4 installation folder. Pick the right folder and click **OK**. Click the Tool Directories and make sure that the paths are pointing to directories matching your installation. For example:
 - **CCS Installation:** `C:\Program Files\Texas Instruments\ccsv4\`
 - **Code Generation Tools:** `C:\Program Files\Texas Instruments\ccsv4\tools\compiler\C2000\`
 - **DSP/BIOS Installation:** `C:\Program Files\Texas Instruments\bios_5_41_10_36\`

Code Generation and Creation of an .out file using CCSv4:

- Open the model that corresponds to the processor family you are using.

- Open the Target Hardware Resources tab, as described in “Configure Target Hardware Resources” on page 35-3, and set the **IDE/Tool chain** parameter to Texas Instruments Code Composer Studio v4 (makefile generation only).
- Change the selected board and processor to match your hardware.
- Click **OK** to save the changes on the Target Hardware Resources tab.
- Click **Incremental build** or press **Ctrl+b** to generate and build an .out executable file.
- Using CCSv4, connect to your board, load and run the .out file.
- Observe the PWM waveform on the oscilloscope.

Run the model using CCSv5

CCSv5 support is provided via a makefile based approach. This requires running `xmakefilesetup` to set the environment. You can ignore the following if you have already gone through these steps. For more information, see “Using Makefiles with Code Composer Studio 4 & 5” on page 43-4.

- Enter `xmakefilesetup` in a MATLAB Command Window.
- In the XMakefile User Configuration dialog that opens, set the **Template** parameter to `gmake`.
- Clear the **Display operational configuration only** check box.
- Set the **Configuration** parameter to `ticcs_c2000_ccsv5`, click **Apply**.
- If you haven’t used this configuration before, a dialog will ask you to browse to your CCSv5 installation folder. Pick the right folder and click **OK**. Click the Tool Directories and make sure that the paths are pointing to directories matching your installation. For example:
 - **CCS Installation:** `C:\ti\ccsv5\`
 - **Code Generation Tools:** `C:\ti\ccsv5\tools\compiler\c2000\`
 - **DSP/BIOS Installation:** `C:\ti\bios_5_41_11_38\`

Code Generation and Creation of an .out file using CCSv5:

- Open the model.

- Open the Target Hardware Resources tab, as described in “Configure Target Hardware Resources” on page 35-3, and set the **IDE/Tool chain** parameter to Texas Instruments Code Composer Studio v5 (makefile generation only).
- Change the selected board and processor to match your hardware.
- Click **OK** to save the changes on the Target Hardware Resources tab.
- Click **Incremental build** or press **Ctrl+b** to generate and build an .out executable file.
- Using CCSv5, connect to your board, load and run the .out file.
- Observe the PWM waveform on the oscilloscope.

Configuring Acquisition Window Width for ADC Blocks

In this section...

“What Is an Acquisition Window?” on page 44-54

“Configuring ADC Parameters for Acquisition Window Width” on page 44-56

What Is an Acquisition Window?

ADC blocks take a signal from an analog source and measure it with a digital device. The digital device does not measure in a continuous process, but in a series of discrete measurements, close enough together to approximate the source signal with the required accuracy.

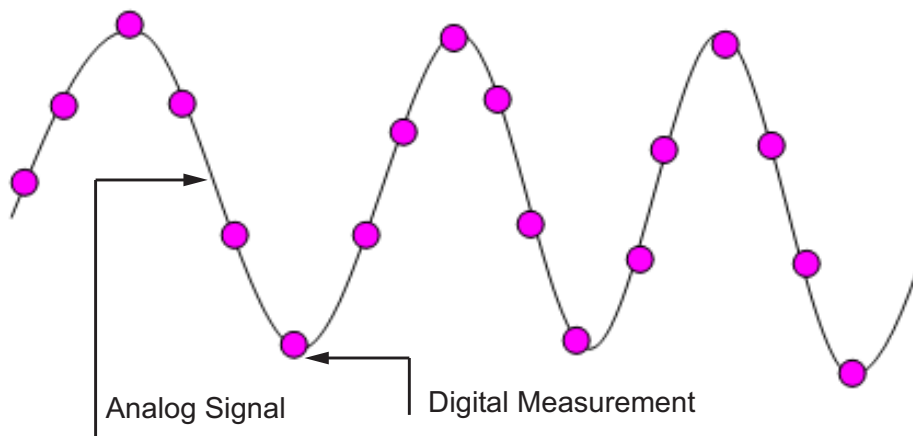

The digital measurement itself is not an instantaneous process, but is a measurement window, where the signal is acquired and measured, as shown in the following figure.

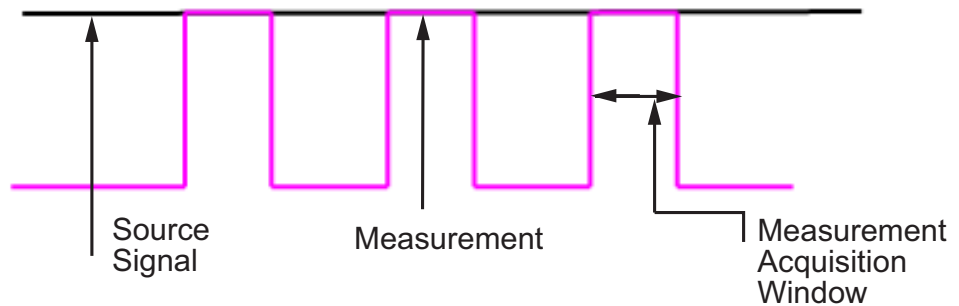

Ideally, as soon as the measurement window is opened, the actual signal coming in would be measured perfectly. In reality the signal does not reach its full magnitude immediately. The measurement process can be modeled by a circuit similar to the one shown in the following figure for the ADC found on the F2812 eZdsp

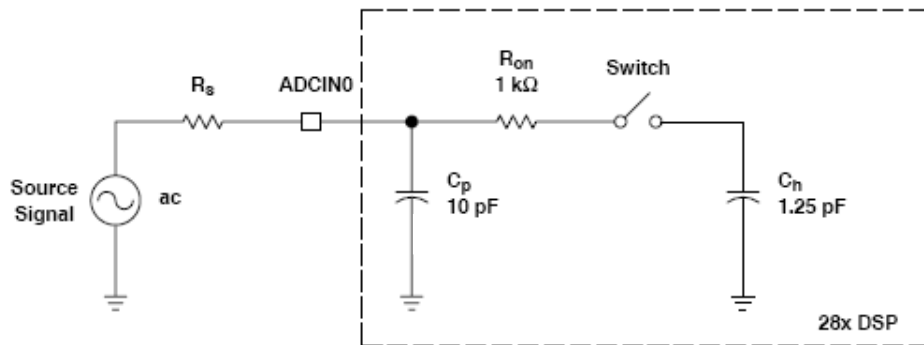

where the measurement circuit is characterized by a certain capacitance. In the preceding figure, when the switch is closed, the measurement begins. In this circuit, which is characterized by its capacitance, the signal received is not in a form of a step function as shown by the ideal measurement, but a ramp up to the true signal magnitude. The following figure shows what happens to the signal when the sampler switch is closed and the signal is received to be measured.

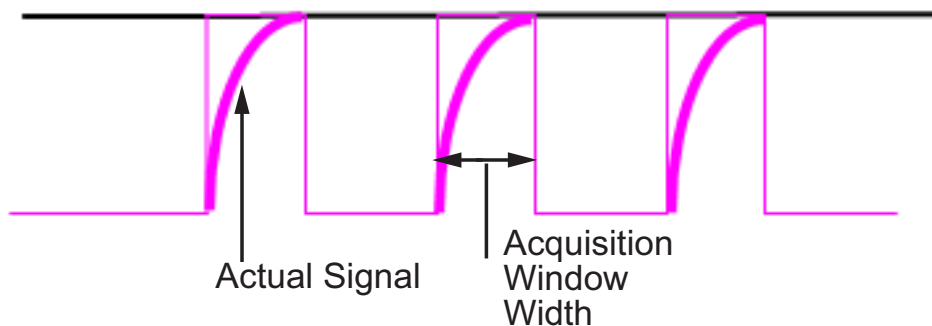

Because the signal acquisition is not instantaneous, it is very important to set a wide enough acquisition window to allow the signal to ramp up to full strength before the measurement is taken. If the window is too narrow, the measurement is taken before the signal has reached its full magnitude, resulting in erroneous data. If the window is too wide, the source signal itself may change, and the sampling may be too infrequent to reflect the actual value, also resulting in erroneous data. You must calculate the width of the acquisition window based on the circuit characteristics of resistance and capacitance of your specific circuit. Then, using the ADC parameters described in the following section, you can configure the acquisition window width.

Configuring ADC Parameters for Acquisition Window Width

- “Accessing the ADC Parameters” on page 44-56
- “Configure Acquisition Window Width Using ADC Parameters” on page 44-59

Accessing the ADC Parameters

The ADC parameters can be set from the **Peripherals tab** of the Target Hardware Resources tab.

- You can set **ACQ_PS** — Acquisition Prescaler — to a value from 0 to 15. To obtain the actual value, increment the setting by 1. This produces an actual range from 1 to 16.

- You can set **ADCLKPS** — AD Clock Prescaler — to a value from 0 to 15. To obtain the actual value, increment the setting by 1. This produces an actual range from 1 to 16.
- You can set **CPS** — Clock Prescaler — to a value from 0 to 1. To obtain the actual value, increment the setting by 1. This produces an actual range from 1 to 2.

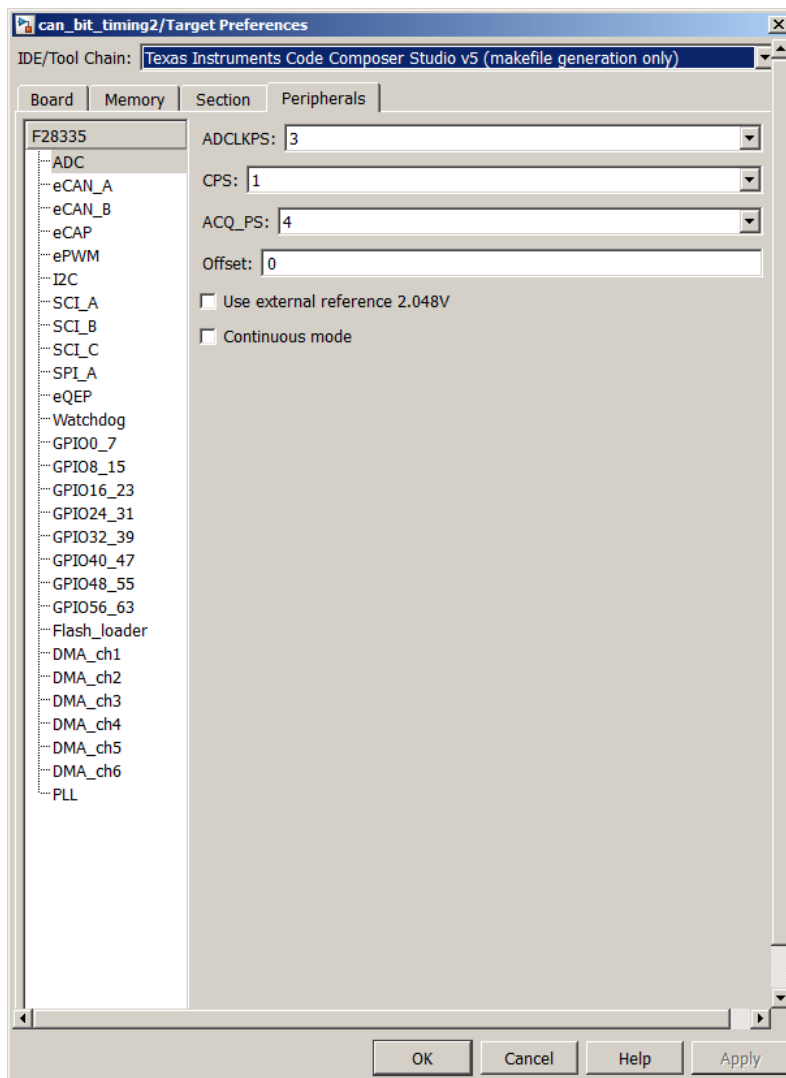

These three prescalers serve to reduce the speed of the clock and to set the acquisition window width. The following diagram shows how these prescalers are used.

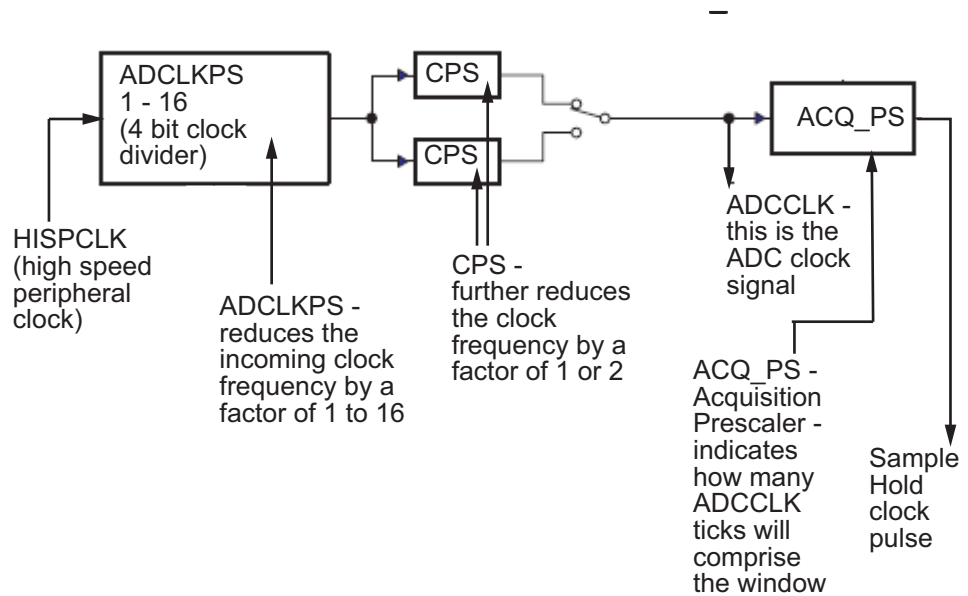

In the preceding diagram, the high speed peripheral clock frequency is received and then divided by the **ADCLKPS**. The reduced clock frequency is then further divided by **CPS**. The resulting frequency is the **ADCCLK** signal. The value of **ACQ_PS** then determines how many **ADCCLK** ticks comprise one S/H (sample and hold) period, or in other words, the length of the acquisition window.

Configure Acquisition Window Width Using ADC Parameters

The following examples show how you can use ADC parameters to configure the acquisition window width:

Example 1:

If the HISPCLK = 30 MHz, and **ADCLKPS**=1 (which is a value of 2), the result is 15 MHz.

If **CPS**= 1 (which is a value of 2), then **ADCCLK** = 7.5 MHz.

If **ACQ_PS** = 0 (which is a value of 1), then the sample/hold period is 1 **ADCCLK** tick, or .1333 microseconds.

Example 2:

If the HISPCLK = 30 MHz, and **ADCLKPS**=1 (which is a value of 2), the result is 15 MHz.

If **CPS**= 1 (which is a value of 2), then **ADCCLK** = 7.5 MHz.

If **ACQ_PS** = 15 (which is a value of 16), then the sample/hold period is 16 **ADCCLK** ticks, or 2.1333 microseconds.

Note HISPCLK is set automatically for the user, and it is not possible to change the rate. For more information, see “High-Speed Peripheral Clock” on page 44-8

Real-Time Data Exchange via RTDX™

This example shows how to use the **From RTDX** and **To RTDX** blocks to send data from host to target and receive data from target to host. The model implements a simple sine wave generator that runs on the F28335 board.

NOTE: The Real-Time Data Exchange via RTDX™ supports only Code Composer Studio v3.3.

Required Hardware:

- Spectrum Digital F2808 eZdsp
- Spectrum Digital F2812 eZdsp
- Spectrum Digital F28044 eZdsp
- Spectrum Digital F28335 eZdsp
- Texas Instruments F2808/F28027/F28035/F28069/F28335/F28343/F28346 ControlCARD with docking station
- Texas Instruments F28027/F28069 ControlSTICK

Available versions of this example:

This example can be run on different boards by changing the processor selection on the Target Hardware Resources tab of the model: `c28x_rtdxtest`

Model

The following figure shows the example model.

Real-Time Data Exchange via RTDX

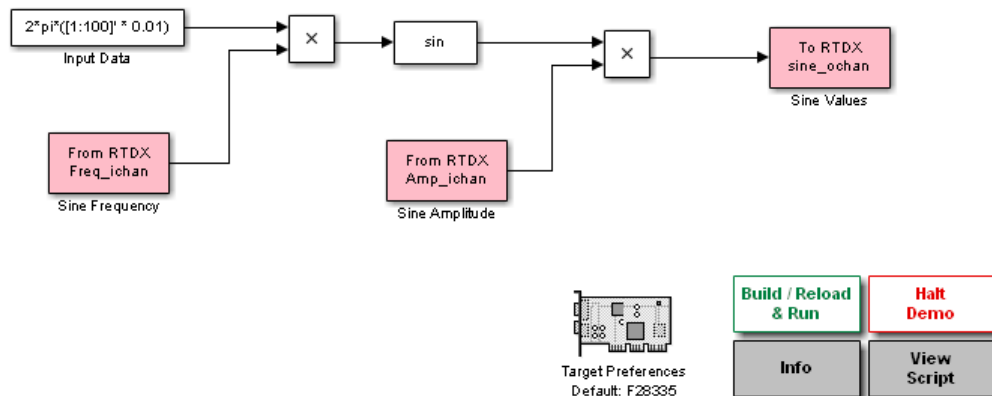

Copyright 2005-2012 The MathWorks, Inc.

Description

The first step to run this example is to generate code for the model and to build it to run on the target. Once the model is running, we use a MATLAB script to read the sine wave values from the channel specified by the "To RTDX" block and plot them. To change the frequency and amplitude of the sine wave while it is running on the target, we use the same MATLAB script to write data to the channels specified by the "From RTDX" blocks. Note that the RTDX™ channel names specified in the RTDX blocks in the Simulink model are the same channel names used in the MATLAB script. Open the example script to see the specific MATLAB code used to establish RTDX communication.

How to Run the Example

- Open the model `c28x_rtdxtest`.
- The model is configured by default for the F28335 processor. Open the Target Hardware Resources tab to select a different processor.
- Click **OK** to save the changes on the Target Hardware Resources tab.
- Click **Build/Reload & Run** to generate, build, load and run the program.

SPI-Based Control of PWM Duty Cycle

This example shows how to use the SPI Receive, SPI Transmit, PWM, and Memory Copy blocks to generate a PWM waveform.

Required Hardware:

- Spectrum Digital F2808/F2812/F28335 eZdsp
- Texas Instruments F2808/F28027/F28035/F28044/F28069/F28335/F28343/F28346 ControlCARD with docking station
- Texas Instruments F28027/F28069 ControlSTICK
- Oscilloscope and probes

Available versions of this example:

- **F281x** based board: c281x_spitest
- **F280x/F2823x/F2833x** based board: c280x_2833x_spitest
- **Piccolo F2802x/F2803x/F2806x** based board: c280xx_spitest

Note: This model only runs with **Code Composer Studio v3.3**

Model

The following figure shows the example model.

SPI-Based Control of PWM Duty Cycle

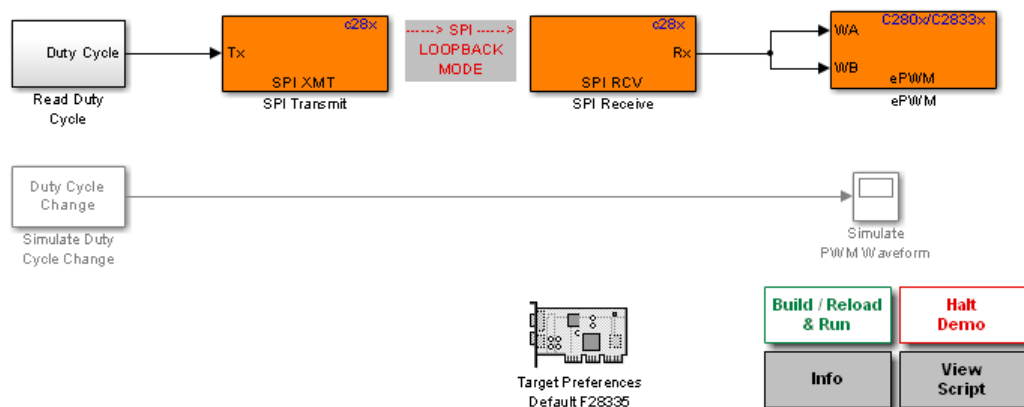

Copyright 2007-2012 The MathWorks, Inc.

Description

Memory Copy block labeled "Read Duty Cycle" reads duty cycle value stored at the memory location 0x8FF0. "C28xx SPI Transmit" block transmits this value, while "C28xx SPI Receive" receives it. The duty cycle value is then sent to the PWM1. The duty cycle of the generated pulse waveform is determined by the relative ratio of the received pulse width value and the pulse period which is fixed at 64000 clock cycles. The duty cycle toggles between 25%, 50%, and 75% based on user selection.

PWM Duty Cycle can be changed while the generated code is running using write function. This method writes selected value to the memory location 0x8FF0. Select either 25%, 50%, or 75% value from the GUI that opens up when "Build/Reload & Run" is pressed.

'Enable loopback' mode is checked for 'SPI_A' on the peripherals tab of the Target Hardware Resources tab. This is required to get the transmitted data back to the processor. If this mode is disabled, SPI_A transmitter and receiver have to be connected.

Note that "Simulate Duty Cycle Change" and "Simulate PWM Waveform" are dedicated to simulation only. Use these blocks to simulate and observe effects achieved with the generated code.

Hardware Connections

Connect the output of PWM1 on the board to the analog input of the oscilloscope.

Note that SPI module is set to work in "loopback" mode. External SPI hardware is not needed. As an alternative, the user may disable SPI loopback mode and bridge SPI transmit and receive pins on each of the following:

- F2812eZdsp (connector P8 pins 23 and 24)
- F2808 eZdsp (connector P8 pins 9 and 10)
- F28335 eZdsp connector P8 pins 9 and 10)
- Texas Instruments F28027/F28069 controlSTICK (connector J1 pins 20 and 24)
- Texas Instruments controlCARD with docking station (GPIO 16 and 17)

How to Run the Example in Simulation

- Open this model.
- Click "Start simulation" button.
- Double-click on the "Duty Cycle Change" block and select a new duty cycle value.
- Observe the PWM waveform change.

How to Run the Example on the Board

- Open the model corresponding to the family of processor you are using.
- Each model is configured for a default processor, open the Target Hardware Resources tab to select a different processor.
- Go to **Peripherals > SPI_A**. Check **Enable loopback**. If your processor is F2803x/F2806x, select **GPIO16** for **SOMI pin assignment** and **GPIO17** for **SIMO pin assignment**.

- Click **Build/Reload & Run** to generate, build, load and run the program.
- Select a new duty cycle value in the dialog that opens.
- Observe the PWM waveform on the oscilloscope.

HIL Verification of IIR Filter via SCI

This example shows HIL verification of an IIR filter using serial communication interface between a host simulation and generated code on a TI C28x processor.

Required hardware:

- Spectrum Digital F2808 eZdsp
- Spectrum Digital F2812 eZdsp
- Spectrum Digital F28044 eZdsp
- Spectrum Digital F28335 eZdsp

On the following boards the embedded xds100 JTAG can be used as a serial connection over USB. Jumper and switch settings with corresponding FTDI drivers are required to use this serial communication technique.

- Texas Instruments
F2808/F28027/F28035/F28044/F28069/F28335/F28343/F28346
ControlCARD with docking station
- Texas Instruments F28027/F28069 ControlSTICK

Available versions of this example:

This example model `c2000scitest` can be used on a variety of boards.

Host Model

The following figure shows the host model.

HIL Verification of IIR Filter via SCI

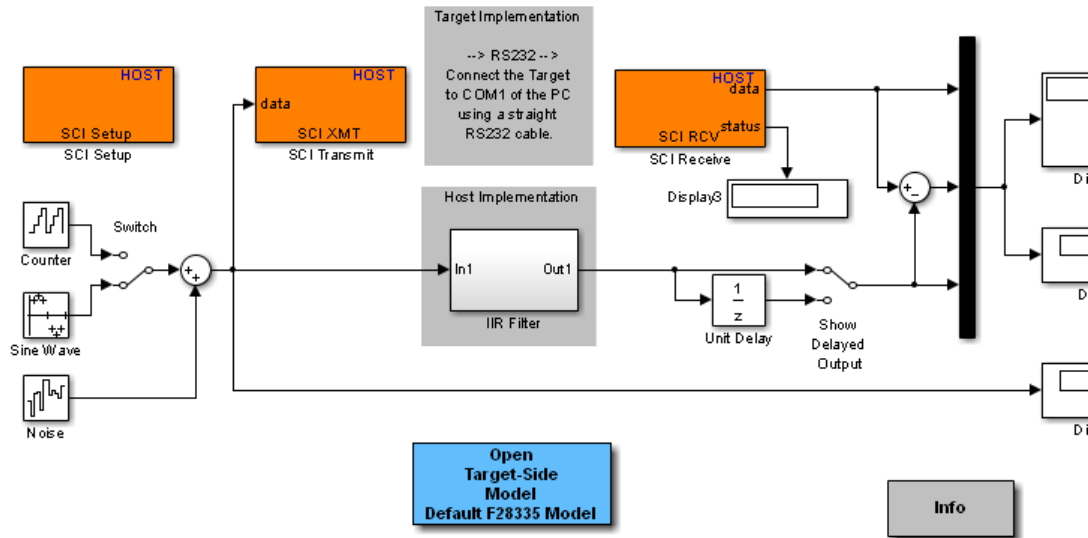

Copyright 2005-2012 The MathWorks, Inc.

Target Model

The following figure shows the target model.

HIL Verification of IIR Filter Using SCI

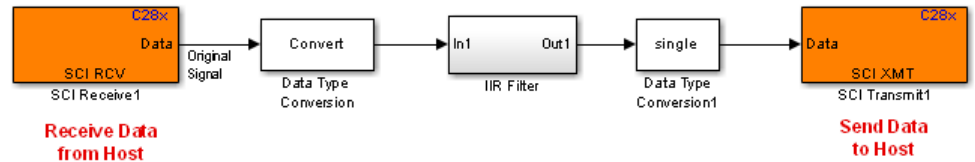

Copyright 2006-2012 The MathWorks, Inc.

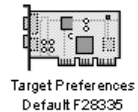

Description

This example shows HIL verification of an IIR filter using serial communication interface between a host simulation and generated code on an c28x processor-based target board.

Based on the position of the manual switch, either a saw-tooth or sine waveform is passed to the Host-side SCI Transmit block and sent to the target. The stream of data is received from the target the via Host-side SCI Receive block and sent to the Simulink scope block.

The same algorithm runs on the target and the host side at the same time. The scope displays three signals showing the result of the simulation compared with the result of the algorithm running on the target. Because the algorithm uses an IIR filter, its output is therefore dependent on every sample time that occurs from the beginning of the simulation. Using an IIR filter clearly shows the time consistency between the simulation and the generated code.

You can add a delay in the simulation by using the "Show Delayed Output" switch. This delay can be used to verify the time consistency between both models.

Hardware Connections

- Connect the RS232 connector of your computer to the RS232 connector of the F28xx chip-based board.
- F2812 eZdsp is not equipped with RS232 transceivers. You must add RS232 transceivers to this board to run this example.
- ControlCARDS with Docking Stations, ControlSTICK boards can support serial over the xds100 USB JTAG connection. Jumper and switch settings with corresponding FTDI drivers are required to use this serial communication technique.

How to Run the Example

The following sections explain how to configure, build, and deploy the executable.

Note: The host model is set to use "COM1". Configure the SCI Setup, SCI Transmit, and SCI Receive blocks to use a different COM port.

With Code Composer Studio v3.3 (CCSv3.3) - Default

- Open the model `c2000scitest`
- Double-Click on "Open Target-Side Model Default F28335". This opens the target model.
- The model is configured by default for the F28335 processor. Open the Target Hardware Resources tab to select a different processor.
- Go to "Peripherals" > "SCI_A", and change the "Communication mode" to "Protocol".
- Click "OK" to save the changes on the Target Hardware Resources tab.
- Click "Build Model" button or press "Ctrl+B" to generate, build, load and run the program on the target.
- Click "Run" to simulate the model `c2000scitest`

Change the manual switch position to select a different input signal.

With Code Composer Studio v4 (CCSv4)

CCSv4 support is provided via a makefile based approach. This requires running `xmakefilesetup` to set the environment. You can ignore the following if you have already gone through these steps. For more information, please refer to the `Xmakefile Documentation`

- Run `XMakefile User Configuration`.
- Set the `Template` parameter to `"gmake"`.
- Uncheck the `"Display operational configuration only"` checkbox.
- Set the `Configuration` parameter to `"ticcs_c2000_ccsv4"`, click `"Apply"`, if you haven't used this tool before, a dialog will ask you to browse to your CCSv4 installation folder. Pick the right folder and click `"OK"`.
- Click on the `"Tool Directories"` and make sure that the paths are pointing to directories matching your installation. For example:

1 `C:\Program Files\Texas Instruments\ccsv4\` for `"CCS Installation"`.

2 `C:\Program Files\Texas Instruments\ccsv4\tools\compiler\C2000\` for `"Code Generation Tools"`.

3 `C:\Program Files\Texas Instruments\bios_5_41_10_36\` for `"DSP/BIOS Installation"`.

Code Generation and Creation of an `.out` file using CCSv4:

- Open the model `c2000scitest`.
- Double-Click on `"Open Target-Side Model Default F28335"`. This opens the target model.
- Open the `Target Hardware Resources` tab and set the **IDE/Tool chain** parameter to `Texas Instruments Code Composer Studio v4 (makefile generation only)`.
- Change the selected board and processor to match your hardware.
- Go to `"Peripherals" > "SCI_A"`, and change the `"Communication mode"` to `"Protocol"`.
- Click `"OK"` to save the changes on the `Target Hardware Resources` tab.

- Click "Build Model" button or press "Ctrl+B" to generate and build an .out executable file.
- Using CCSv4, connect to the Hardware and load and run the .out file.
- Now simulate the model c2000scitest.

Change the manual switch position to select a different input signal.

With Code Composer Studio v5 (CCSv5)

CCSv5 support is provided via a makefile based approach. This requires running xmakefilesetup to set the environment. You can ignore the following if you have already gone through these steps. For more information, please refer to the Xmakefile Documentation

- Run XMakefile User Configuration.
- Set the Template parameter to "gmake".
- Uncheck the "Display operational configuration only" checkbox.
- Set the Configuration parameter to "ticc_c2000_ccsv5", click "Apply", if you haven't used this tool before, a dialog will ask you to browse to your CCSv5 installation folder. Pick the right folder and click "OK".
- Click on the "Tool Directories" and make sure that the paths are pointing to directories matching your installation. For example:

1 *C:\ti\ccsv5* for "CCS Installation".

2 *C:\ti\ccsv5\tools\compiler\c2000* for "Code Generation Tools".

3 *C:\ti\bios_5_41_11_38* for "DSP/BIOS Installation".

Code Generation and Creation of an .out file using CCSv5:

- Open the model c2000scitest.
- Double-Click on "Open Target-Side Model Default F28335". This opens the target model.

- Open the Target Hardware Resources tab and set the **IDE/Tool chain** parameter to Texas Instruments Code Composer Studio v4 (makefile generation only).
- Change the selected board and processor to match your hardware.
- Go to "Peripherals" > "SCI_A", and change the "Communication mode" to "Protocol".
- Click "OK" to save the changes on the Target Hardware Resources tab.
- Click "Build Model" button or press "Ctrl+B" to generate and build an .out executable file.
- Using CCSv5, connect to the Hardware and load and run the .out file.
- Now simulate the model c2000scitest.

Change the manual switch position to select a different input signal.

CAN-Based Control of PWM Duty Cycle

This example shows how to use the CAN Receive, CAN Transmit, PWM, and C2812 Memory Copy blocks to generate a pulse waveform.

Required Hardware:

- Spectrum Digital F2808/F2812/F28335 eZdsp
- Texas Instruments F2808/F28035/F28069/F28335/F28343 ControlCARD with docking station
- Texas Instruments F28069 ControlSTICK
- Oscilloscope and probes

Available versions of this example:

- **F281x** based board: c281x_cantest
- **F280x/F2823x/F2833x** based board: c280x_2833x_cantest
- **Piccolo F2803x/F2806x** based board: c280xx_cantest

Note: These models only runs with **Code Composer Studio v3.3**

Model

The following figure shows the example model.

CAN-Based Control of PWM Duty Cycle

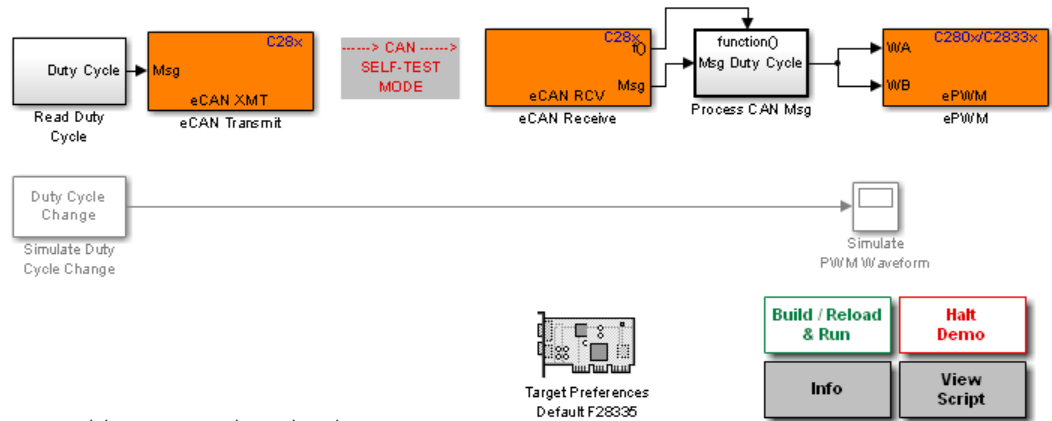

Description

Memory Copy block labeled "Read Duty Cycle" reads duty cycle value stored at the memory location 0x8FF0. "Transmit CAN Msg" block uses mailbox 5 to transmit this value packed in a standard CAN message frame, while "Receive CAN Msg" uses mailbox 0 to receive it. When the CAN message is received, "Process CAN Msg" unpacks the duty cycle value and sends it to the PWM1. The duty cycle of the generated pulse waveform is determined by the relative ratio of the received pulse width value and the pulse period which is fixed at 64000 clock cycles. The duty cycle toggles between 25%, 50%, and 75% based on user selection.

PWM Duty Cycle can be changed while the generated code is running using the write function. This method writes selected value to the memory location 0x8FF0. Select either 25%, 50%, or 75% value from the GUI that opens up when "Build/Reload & Run" is pressed.

NOTE: 'Self-Test' mode is enabled for eCAN_A to receive the data transmitted back to the processor in the example models. If 'Self-test' mode is disabled, the CAN transmitter and receiver have to be physically connected for the example to work.

Note that "Simulate Duty Cycle Change" and "Simulate PWM Waveform" are dedicated to simulation only. Use these blocks to simulate and observe effects achieved with the generated code.

Hardware Connections

Connect the output of PWM1 on the board to the analog input of the oscilloscope.

Note that CAN module is set to work in "Self Test Mode". External CAN hardware is not needed, as the CAN handshaking signals are emulated in software.

How to Run the Example in Simulation

- Open the model corresponding to the family of processor you are using.
- Click **Start simulation** button
- Double-click on the "**Duty Cycle Change**" block and select a new duty cycle value
- Observe the PWM waveform change

How to Run the Example on the Board

- Open the model corresponding to the family of processor you are using.
- Each model is configured for a default processor, open the Target Hardware Resources tab to select a different processor.
- Go to **Peripherals > eCAN_A** and check **Self-Test Mode**.
- Click the "**Build/Reload & Run**" button to generate, build, load and run the program.
- Select a new duty cycle value in the dialog that opens.
- Observe the PWM waveform on the oscilloscope.

CAN Calibration Protocol and External Mode

This example shows how to use of the CAN Calibration Protocol (CCP) block. You can use either external mode or a third party calibration tool to interact with the real-time application running on the target hardware. CCP provides a means of monitoring signals and altering the parameter values in the application code running on the target.

Required hardware:

- Before running the model in external mode, install Vector-Informatik CAN hardware and drivers on your host computer, and set the baud rate to 1M to match processor CAN configurations.
- Spectrum Digital F2812/F2808/F28335 eZdsp board, F28069 controlSTICK or F2808/F28035/F28044/F28069/F28335 ControlCARD with Docking Station
- The model runs in MATLAB Win32 as Vector-Informatik supports win32

Available versions of this example:

- The example model `c28x_ccp` can be used for TI Piccolo F2803x/F2806x, F28x3x, F280x, F281x series processors. Default F28335 processor is selected.
- The target hardware can be selected from Target Hardware Resources tab for the model

Model

The following figure shows the example model.

CAN Calibration Protocol and Simulink External Mode

Note: F2802x processors do not have an eCAN module

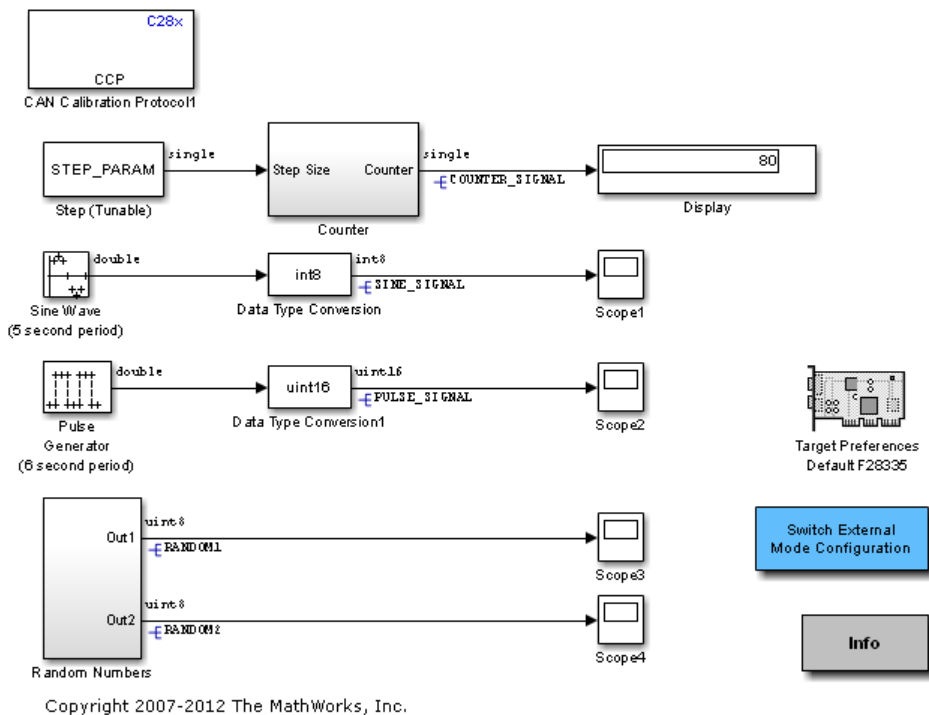

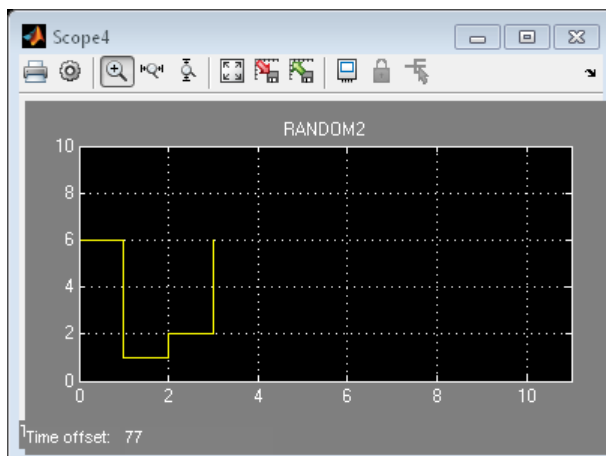
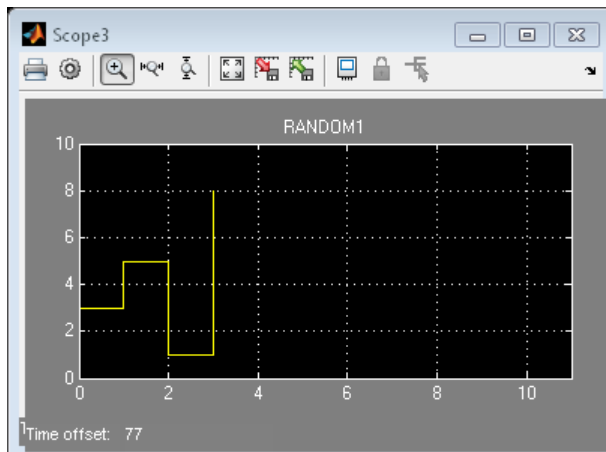

Scope Snapshots

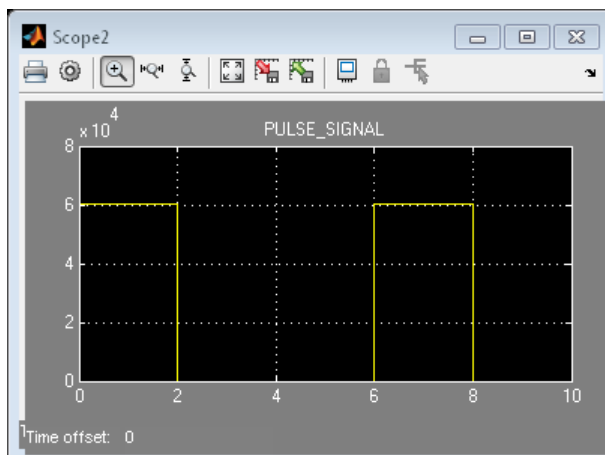
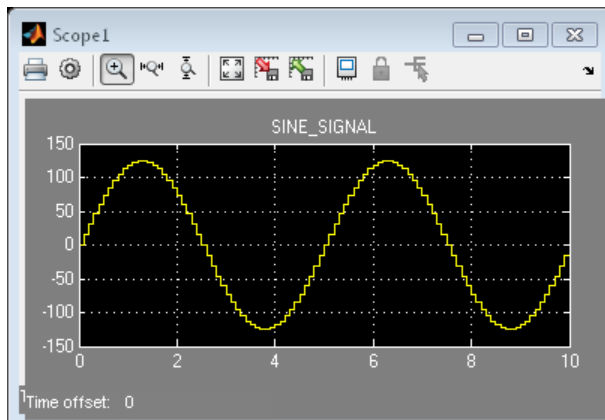

Description

This example shows how to use the c28x CCP block. During code generation, for this model an ASAP2 file is generated. The ASAP2 file contains symbol and memory address information that is used either by external mode or a third party calibration tool. You can use either external mode or a calibration tool to log signals and update parameters on the real-time application.

How to Run the Example

The following sections explain how to configure, build, and deploy the executable.

With Code Composer Studio v3.3 (CCSv3.3) - Default

- While opening the model `c28x_ccp`, a script will be processed as a Pre-Load Function callback. This call can be viewed by selecting `File > Model Properties > Callbacks > PreLoadFcn`.
- The `c2000_ccp_data.m` callback is setting Simulink signals and parameters to resolve Simulink objects used for CCP DAQ lists and Simulink tunable parameters as described in the CCP documentation. This step is required to interact with these signals in real-time using CCP.
- The example model is configured for default processor F28335. Open the Target Hardware Resources tab to select a different processor.
- Build the model. You can press **Ctrl+B** or click **Incremental Build** button on the toolbar of your model.
- Follow the progress of the build in the MATLAB command window, and wait until the project is created and built in Code Composer Studio™.

With Code Composer Studio v4 (CCSv4)

CCSv4 support is provided via a makefile based approach. This requires running `xmakefilesetup` to set the environment. You can ignore the following if you have already gone through these steps. For more information, please refer to the `Xmakefile` Documentation

- Run `XMakefile User Configuration`.
- Set the `Template` parameter to **gmake**.
- Uncheck the **Display operational configuration only** checkbox.
- Set the `Configuration` parameter to `ticcs_c2000_ccsv4`, click **Apply**, if you haven't used this tool before, a dialog will ask you to browse to your CCSv4 installation folder. Pick the right folder and click **OK**.
- Click on the **Tool Directories** and make sure that the paths are pointing to directories matching your installation. For example:

1 *C:\Program Files\Texas Instruments\ccsv4* for **CCS Installation**

2 *C:\Program Files\Texas Instruments\ccsv4\tools\compiler\C2000* for **Code Generation Tools**

3 *C:\Program Files\Texas Instruments\bios_5_41_10_36* for **DSP/BIOS Installation**

Code Generation and Creation of an .out file using CCSv4:

- While opening the model `c28x_ccp`, a script will be processed as a Pre-Load Function callback. This call can be viewed by selecting **File > Model Properties > Callbacks > PreLoadFcn**.
- The `c2000_ccp_data.m` callback is setting Simulink signals and parameters to resolve Simulink objects used for CCP DAQ lists and Simulink tunable parameters as described in the CCP documentation. This step is required to interact with these signals in real-time using CCP.
- Open the Target Hardware Resources tab and set the **IDE/Tool chain** parameter to Texas Instruments Code Composer Studio v4 (makefile generation only).
- Change the selected board and processor to match your hardware.
- Click **OK** to save the changes on the Target Hardware Resources tab.
- Build the model. You can press **Ctrl+B** or click **Incremental Build** button on the toolbar of your model.
- Open CCSv4 and Connect to the Hardware. Load the program on to the Hardware using CCSv4 and run.

With Code Composer Studio v5 (CCSv5)

CCSv5 support is provided via a makefile based approach. This requires running `xmakefilesetup` to set the environment. You can ignore the following if you have already gone through these steps. For more information, please refer to the `Xmakefile` Documentation

- Run `XMakefile User Configuration`.
- Set the Template parameter to **gmake**.
- Uncheck the **Display operational configuration only** checkbox.

- Set the Configuration parameter to **ticcs_c2000_ccsv5**, click **Apply**, if you haven't used this tool before, a dialog will ask you to browse to your CCSv5 installation folder. Pick the right folder and click **OK**.
- Click on the **Tool Directories** and make sure that the paths are pointing to directories matching your installation. For example:

1 *C:\ti\ccsv5* to set **CCS Installation**

2 *C:\ti\ccsv5\tools\compiler\c2000* to set **Code Generation Tools**

3 *C:\ti\bios_5_41_11_38* to set **DSP/BIOS Installation**

Code Generation and Creation of an .out file using CCSv5

- While opening the model `c28x_ccp`, a script will be processed as a Pre-Load Function callback. This call can be viewed by selecting File > Model Properties > Callbacks > PreLoadFcn.
- The `c2000_ccp_data.m` callback is setting Simulink signals and parameters to resolve Simulink objects used for CCP DAQ lists and Simulink tunable parameters as described in the CCP documentation. This step is required to interact with these signals in real-time using CCP.
- Open the Target Hardware Resources tab and set the **IDE/Tool chain** parameter to Texas Instruments Code Composer Studio v5 (makefile generation only).
- Change the selected board and processor to match your hardware.
- Click **OK** to save the changes on the Target Hardware Resources tab.
- Build the model. You can press **Ctrl+B** or click **Incremental Build** button on the toolbar of your model.
- Open CCSv5 and Connect to the Hardware. Load the program on to the Hardware using CCSv5 and run.

Signal Logging and Parameter Tuning with External Mode

The model `c28x_ccp` contains a variety of signals and parameters that can be logged or changed while the application is executing in real-time. Parameter tuning and signal logging is enabled by the CCP block included in the model. Additionally, when the model is built, it must be configured

to generate an ASAP2 file. The ASAP2 file contains information about the signals and parameters that are available for logging or tuning in the real-time application.

The model contains a simple counter with parameterized step size, STEP_PARAM. You can update the parameter STEP_PARAM and log the output of the counter, COUNTER_SIGNAL. Additional signals available for logging are SINE_SIGNAL, PULSE_SIGNAL and the RANDOMx signals.

Before running the model in external mode you must have Vector-Informatik CAN hardware installed on your host computer.

To run the model c28x_ccp in external mode:

- Check that the model is already built and running on the target.
- Configure the model to use External mode as described in “Manual Configuration For External Mode” on page 44-44.
- Run the model in external mode by selecting Simulation > Connect To Target.
- You can now view logged data in the scope windows.
- You can change the parameter STEP_PARAM in the real-time application: first change its value, "STEP_PARAM.Value", in the MATLAB workspace; then update the model to apply this new value to the real-time application; to update the model select Edit > Update Diagram or press **Ctrl+D**.

Signal Logging and Parameter Tuning with a Third Party Calibration Tool

As an alternative to using external mode, you can use a third party calibration tool for signal logging and parameter tuning. The same signals and parameters may be logged or updated as those that are available with external mode.

Using the I2C Bus to Access a Connected EEPROM

This example shows how to use the I2C blocks to access an EEPROM connected to a chip using the I2C bus.

Required Hardware:

- Spectrum Digital F2808/F28335 eZdsp board

Note: C2000 (except c281x) controlSTICK or ControlCARD with Docking Station board is not equipped with I2C EEPROM. You must add I2C EEPROM to this board to run the example.

Available versions of this example:

- For c28x Processors: c28x_i2ctest

Model

The following figure shows the example model.

Using the I2C bus to access a connected EEPROM

Note: This program will access the on-board I2C EEPROM provided on the F28335/F2808 eZdsp.

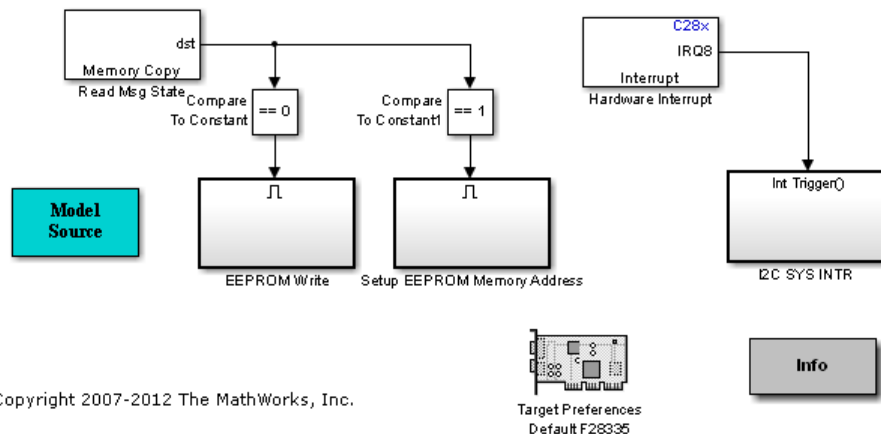

Copyright 2007-2012 The MathWorks, Inc.

Target Preferences
Default F28335

Description

This example shows how to access the EEPROM connected to the I2C bus at I2C slave address 0x50 on an F2808/F28335 eZdsp board.

This program writes 4 bytes to EEPROM and reads back the data from the corresponding EEPROM address to show that communication has occurred.

The I2C Transmit block in the "EEPROM Write" subsystem writes the free-running counter data from the "EEPROM Data" subsystem to the address specified by "EEPROM Memory Addr" subsystem.

When an I2C interrupt is detected, "I2C SYS INTR" subsystem function is executed. As a result, the I2C Receive block reads the EEPROM data in "I2C SYS INTR:ARDY Subsystem:Subsystem". The global array "EEPROM_DATA" contains the received data. You can monitor the value of this array in Code Composer Studio™ Watch Window.

How to Run the Example

The following sections explain how to configure, build, and deploy the executable.

With Code Composer Studio v3.3 (CCSv3.3) - Default

- Open this model `c28x_i2ctest`.
- The model is configured for a default processor F28335. Open the Target Hardware Resources tab to select a different processor.
- In the Target Hardware Resources tab, under the Peripherals tab, select I2C, and check **Enable system interrupt**.
- Once editable, check **Enable SCD Interrupt** and **Enable ARDY interrupt**.
- Click **OK** to save the changes on the Target Hardware Resources tab.
- Click **Incremental build** on the Simulink toolbar or press **Ctrl+B** to generate, build, load and run the program.

With Code Composer Studio v4 (CCSv4)

CCSv4 support is provided via a makefile based approach. This requires running `xmakefilesetup` to set the environment. You can ignore the following if you have already gone through these steps. For more information, please refer to the `Xmakefile Documentation`

- Run `XMakefile User Configuration`.
- Set the `Template` parameter to **gmake**.
- Uncheck the **Display operational configuration only** checkbox.
- Set the `Configuration` parameter to **ticcs_c2000_ccsv4**, click **Apply**, if you haven't used this tool before, a dialog will ask you to browse to your CCSv4 installation folder. Pick the right folder and click **OK**.
- Click on the **Tool Directories** and make sure that the paths are pointing to directories matching your installation. For example:

1 *C:\Program Files\Texas Instruments\ccsv4* for **CCS Installation**.

2 *C:\Program Files\Texas Instruments\ccsv4\tools\compiler\C2000* for **Code Generation Tools**.

3 *C:\Program Files\Texas Instruments\bios_5_41_10_36* for **DSP/BIOS Installation**.

Code Generation and Creation of an `.out` file using CCSv4:

- Open the model `c28x_i2ctest`.
- Open the `Target Hardware Resources` tab and set the **IDE/Tool chain** parameter to `Texas Instruments Code Composer Studio v4 (makefile generation only)`.
- In the `Target Hardware Resources` tab, under the `Peripherals` tab, select `I2C`, and check **Enable system interrupt**.
- Once editable, check **Enable SCD Interrupt** and **Enable ARDY interrupt**.
- Click **OK** to save the changes on the `Target Hardware Resources` tab.
- Click **Incremental build** on the `Simulink` toolbar or press **Ctrl+B** to generate and build an `.out` executable file.

- Open CCSv4 and connect to the Hardware. Load the program on to the Hardware using CCSv4 and run.

With Code Composer Studio v5 (CCSv5)

CCSv5 support is provided via a makefile based approach. This requires running `xmakefilesetup` to set the environment. You can ignore the following if you have already gone through these steps. For more information, please refer to the [Xmakefile Documentation](#)

- Run XMakefile User Configuration.
- Set the Template parameter to **gmake**.
- Uncheck the **Display operational configuration only** checkbox.
- Set the Configuration parameter to **ticcs_c2000_ccsv5**, click **Apply**, if you haven't used this tool before, a dialog will ask you to browse to your CCSv5 installation folder. Pick the right folder and click **OK**.
- Click on the **Tool Directories** and make sure that the paths are pointing to directories matching your installation. For example:

1 `C:\ti\ccsv5\` for **CCS Installation**.

2 `C:\ti\ccsv5\tools\compiler\c2000\` for **Code Generation Tools**.

3 `C:\ti\bios_5_41_11_38\` for **DSP/BIOS Installation**.

Code Generation and Creation of an .out file using CCSv5:

- Open the model `c28x_i2ctest`.
- Open the Target Hardware Resources tab and set the **IDE/Tool chain** parameter to Texas Instruments Code Composer Studio v5 (makefile generation only).
- Change the selected board and processor to match your hardware.
- In the Target Hardware Resources tab, under the Peripherals tab, select I2C, and check **Enable system interrupt**.
- Once editable, check **Enable SCD Interrupt** and **Enable ARDY interrupt**.

- Click **OK** to save the changes on the Target Hardware Resources tab.
- Click **Incremental build** on the Simulink toolbar or press **Ctrl+B** to generate and build an .out executable file.
- Open CCSv5 and connect to the Hardware. Load the program on to the Hardware using CCSv5 and run.

Using the IQmath Library

In this section...

“About the IQmath Library” on page 44-90

“Fixed-Point Numbers” on page 44-91

“Building Models” on page 44-96

About the IQmath Library

- “Introduction” on page 44-90
- “Common Characteristics” on page 44-91
- “References” on page 44-91

Introduction

The C28x IQmath Library blocks perform processor-optimized fixed-point mathematical operations. These blocks correspond to functions in the Texas Instruments C28x IQmath Library, an assembly-code library for the TI C28x family of digital signal processors.

Note The implementation of this library for the TI C28x processor produces the same simulation and code-generation output as the TI version of this library, but it does not use a global Q value, as does the TI version. The Q format is dynamically adjusted based on the Q format of the input data.

The IQmath Library blocks generally input and output fixed-point data types and use numbers in Q format. The C28x IQmath Library block reference pages discuss the data types accepted and produced by each block in the library. For more information, consult the “Fixed-Point Numbers” on page 44-91 and “Q Format Notation” on page 44-93 topics, as well as the Fixed-Point Designer product documentation, which includes more information on fixed-point data types, scaling, and precision issues.

You can use IQmath Library blocks with some core Simulink blocks and Fixed-Point Designer blocks to run simulations in Simulink models before generating code. Once you develop your model, you can generate equivalent code that is optimized to run on a TI C28x DSP. During code generation, a call is made to the IQmath Library for each IQmath Library block in your model to create target-optimized code. To learn more about creating models that include IQmath Library blocks and blocks from other blocksets, consult “Building Models” on page 44-96.

Common Characteristics

The following characteristics are common to IQmath Library blocks:

- Sample times are inherited from driving blocks.
- Blocks are single rate.
- Parameters are not tunable.
- Blocks support discrete sample times.

To learn more about characteristics particular to each block in the library, see the individual block reference pages.

References

For detailed information on the IQmath library, see the user’s guide for the *C28x IQmath Library - A Virtual Floating Point Engine*, Literature Number SPRC087, available at the Texas Instruments Web site. The user’s guide is included in the zip file download that also contains the IQmath library (registration required).

Fixed-Point Numbers

- “Notation” on page 44-92
- “Signed Fixed-Point Numbers” on page 44-93
- “Q Format Notation” on page 44-93

Notation

In digital hardware, numbers are stored in binary words. A binary word is a fixed-length sequence of binary digits (1s and 0s). How hardware components or software functions interpret this sequence of 1s and 0s is defined by the data type.

Binary numbers are used to represent either fixed-point or floating-point data types. A fixed-point data type is characterized by the word size in bits, the binary point, and whether it is signed or unsigned. The position of the binary point is the means by which fixed-point values are scaled and interpreted.

For example, a binary representation of a fractional fixed-point number (either signed or unsigned) is shown below:

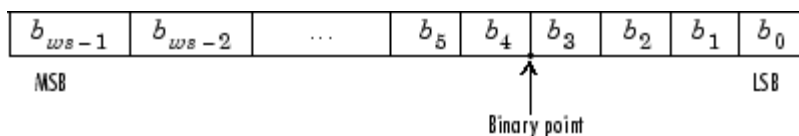

where

- b_i is the i th binary digit.
- ws is the word size in bits.
- b_{ws-1} is the location of the most significant (highest) bit (MSB).
- b_0 is the location of the least significant (lowest) bit (LSB).
- The binary point is shown four places to the left of the LSB. In this example, therefore, the number is said to have four fractional bits, or a fraction length of 4.

Note For Embedded Coder, the results of fixed-point and integer operations in MATLAB/Simulink match the results on the hardware target down to the least significant bit (bit-trueness). The results of floating-point operations in MATLAB/Simulink do not match those on the hardware target, because the libraries used by the third-party compiler may be different from those used by MATLAB/Simulink.

Signed Fixed-Point Numbers

Signed binary fixed-point numbers are typically represented in one of three ways:

- Sign/magnitude
- One's complement
- Two's complement

Two's complement is the most common representation of signed fixed-point numbers and is used by TI digital signal processors.

Negation using signed two's complement representation consists of a bit inversion (translation to one's complement representation) followed by the binary addition of a 1. For example, the two's complement of 000101 is 111011, as follows:

000101 ->111010 (bit inversion) ->111011 (binary addition of a 1 to the LSB)

Q Format Notation

The position of the binary point in a fixed-point number determines how you interpret the scaling of the number. When it performs basic arithmetic such as addition or subtraction, hardware uses the same logic circuits regardless of the value of the scale factor. In essence, the logic circuits do not have knowledge of a binary point. They perform signed or unsigned integer arithmetic — as if the binary point is to the right of b_0 . Therefore, you determine the binary point.

In the IQmath Library, the position of the binary point in the signed, fixed-point data types is expressed in and designated by Q format notation. This fixed-point notation takes the form

$Q_{m.n}$

where

- Q designates that the number is in Q format notation — the Texas Instruments representation for signed fixed-point numbers.

- m is the number of bits used to designate the two's complement integer portion of the number.
- n is the number of bits used to designate the two's complement fractional portion of the number, or the number of bits to the right of the binary point.

In Q format, the most significant bit is designated as the sign bit. Representing a signed fixed-point data type in Q format requires $m+n+1$ bits to account for the sign.

Note The range and resolution varies for different Q formats. For specific details, see Section 3.2 in the *Texas Instruments C28x Foundation Software, IQmath Library Module User's Guide*.

When converting from Q format to floating-point format, the accuracy of the conversion depends on the values and formats of the numbers. For example, for single-precision floating-point numbers that use 24 bits, the resolution of the corresponding 32-bit number cannot be achieved. The 24-bit number approximates its value by truncating the lower end. For example:

32-bit integer	11110000	11001100	10101010	00001111
Single-precision float	+1.1110000	11001100	10101010	x 231
Corresponding value	11110000	11001100	10101010	00000000

Expressing Q Format – Q.15. For example, a signed 16-bit number with $n = 15$ bits to the right of the binary point is expressed as

Q0.15

in this notation. This is (1 sign bit) + ($m = 0$ integer bits) + ($n = 15$ fractional bits) = 16 bits total in the data type. In Q format notation, the $m = 0$ is often implied, as in

Q.15

In Fixed-Point Designer software, this data type is expressed as

sfrac16

or

`sfix16_En15`

In DSP System Toolbox software, this data type is expressed as

`[16 15]`

Expressing Q Format – Q1.30. Multiplying two Q0.15 numbers yields a product that is a signed 32-bit data type with $n = 30$ bits to the right of the binary point. One bit is the designated sign bit, thereby forcing m to be 1:

$$m+n+1 = 1+30+1 = 32 \text{ bits total}$$

Therefore, this number is expressed as

`Q1.30`

In Fixed-Point Designer software, this data type is expressed as

`sfix32_En30`

In DSP System Toolbox software, this data type is expressed as

`[32 30]`

Expressing Q Format – Q-2.17. Consider a signed 16-bit number with a scaling of $2^{(-17)}$. This requires $n = 17$ bits to the right of the binary point, meaning that the most significant bit is a *sign-extended* bit.

Sign extension fills additional bits with the value of the MSB. For example, consider a 4-bit two's complement number 1011. When this number is extended to 7 bits with sign extension, the number becomes 1111101 and the value of the number remains the same.

One bit is the designated sign bit, forcing m to be -2:

$$m+n+1 = -2+17+1 = 16 \text{ bits total}$$

Therefore, this number is expressed as

`Q-2.17`

In Fixed-Point Designer software, this data type is expressed as

`sfix16_En17`

In DSP System Toolbox software, this data type is expressed as

`[16 17]`

Expressing Q Format – Q17.-2. Consider a signed 16-bit number with a scaling of 2^2 or 4. This means that the binary point is implied to be 2 bits to the right of the 16 bits, or that there are $n = -2$ bits to the right of the binary point. One bit must be the sign bit, thereby forcing m to be 17:

$$m+n+1 = 17+(-2)+1 = 16$$

Therefore, this number is expressed as

`Q17. -2`

In Fixed-Point Designer software, this data type is expressed as

`sfix16_E2`

In DSP System Toolbox software, this data type is expressed as

`[16 -2]`

Building Models

- “Overview” on page 44-96
- “Converting Data Types” on page 44-97
- “Using Sources and Sinks” on page 44-97
- “Choosing Blocks to Optimize Code” on page 44-97
- “Double and Single-Precision Parameter Values” on page 44-97

Overview

You can use IQmath Library blocks in models along with certain core Simulink, Fixed-Point Designer, and other blockset blocks. This section discusses issues you should consider when building a model with blocks from these different libraries.

Converting Data Types

It is vital to make sure that blocks you connect in a model have compatible input and output data types. In most cases, IQmath Library blocks handle only a limited number of specific data types. You can refer to the block reference page for a discussion of the data types that the block accepts and produces.

When you connect IQmath Library blocks and Fixed-Point Designer blocks, you often need to set the data type and scaling in the block parameters of the Fixed-Point Designer block to match the data type of the IQmath Library block. Many Fixed-Point Designer blocks allow you to set their data type and scaling through inheritance from the driving block, or through backpropagation from the next block. This can be a good way to set the data type of a Fixed-Point Designer block to match a connected IQmath Library block.

Some DSP System Toolbox blocks and core Simulink blocks also accept fixed-point data types. Choose the right settings in these blocks' parameters when you connect them to an IQmath Library block.

Using Sources and Sinks

The IQmath Library does not include source or sink blocks. Use source or sink blocks from the core Simulink library or Fixed-Point Designer in your models with IQmath Library blocks.

Choosing Blocks to Optimize Code

In some cases, blocks that perform similar functions appear in more than one blockset. For example, the IQmath Library and Fixed-Point Designer software have a Multiply block. When you are building a model to run on C2000 DSP, choosing the block from the IQmath Library yields better optimized code. You can use a similar block from another library if it gives you functionality that the IQmath Library block does not support, but you will generate code that is less optimized.

Double and Single-Precision Parameter Values

When you enter double-precision floating-point values for parameters in the IQ Math blocks, the software converts them to single-precision values that

are compatible with the behavior on c28x processor. For example, with the **Ramp Generator** block, the software converts the value of the **Maximum step angle** parameter to a single-precision value.

Programming Flash Memory

In this section...

“Introduction” on page 44-99

“Installing TI Flash APIs” on page 44-100

“Configuring the DSP Board Bootloader” on page 44-100

“Configuring the Software for Automatic Flash Programming” on page 44-101

“Selectively Erase, Program, or Verify Specific Flash Sectors” on page 44-101

“Placing Additional Code or Data on Unused Flash Sectors” on page 44-102

Introduction

The Embedded Coder software includes a feature for programming Flash memory on the target hardware. You can configure this feature to automatically program Flash memory when you build and execute models for DSP boards. You can also use the Flash programming feature to selectively erase, program, or verify specific sectors of Flash memory.

Note Reprogramming Flash memory thousands of times may deplete its ability to hold data. Consult the manufacturer’s documentation for specifications.

Requirements:

- A F2812, F2808, or F28335 eZdsp board
- A working Simulink model
- The TI Flash API for your specific target

Installing TI Flash APIs

- 1 Visit the Texas Instruments Web site and download the TI Flash API installation software for your target:
 - F281x: <http://focus.ti.com/docs/toolsw/folders/print/sprc125.html>
 - F280x: <http://focus.ti.com/docs/toolsw/folders/print/sprc193.html>
 - F2802x: <http://focus.ti.com/docs/toolsw/folders/print/sprc848.html>
 - F2804x: <http://focus.ti.com/docs/toolsw/folders/print/sprc325.html>
 - F2823x: <http://focus.ti.com/docs/toolsw/folders/print/sprc665.html>
 - F2833x: <http://focus.ti.com/docs/toolsw/folders/print/sprc539.html>
- 2 Start the TI Flash API installation software (.exe) contained in the ZIP file.
- 3 During installation, *use the default folder location* for **Location to Save Files**.

Otherwise, each time you create a model, you must configure **Specify API Location**, located under the **Peripherals** tab of the Target Hardware Resources tab.
- 4 Complete the installation process.

Configuring the DSP Board Bootloader

Configure the bootloader switch or jumper on the DSP board so that, upon startup, the DSP board executes the program from Flash memory. Consult the manufacturer's hardware documentation to identify the specific switch and settings.

Typically, you can enable the bootloader switch or jumper by moving it from the factory default position (Flash disabled) to the opposite position (enabled). For example:

- On the F2812 eZdsp, change jumper JP7 from the factory default setting.
- On the F2808 eZdsp, change switches 1 and 3 on bank SW1 from the factory default settings.

- On F28335 eZdsp, change switch 3 on bank SW1 from the factory default setting.

Configuring the Software for Automatic Flash Programming

Configure Embedded Coder software to program Flash memory on the target board when you build and execute a model.

- 1 On your keyboard, press Ctrl+E to open the Configuration Parameters dialog, select the Code Generation > Coder Target pane.
- 2 On the Tool Chain Automation tab, set **Build Action** to **Build_and_execute**.
- 3 On the Target Hardware Resources tab, set **Board** to a board whose name includes (boot from flash).
- 4 Select the **Peripherals** tab, and then select **Flash_loader**
- 5 Set **Enable flash programmer** to **Erase, Program, Verify**.
- 6 Click **OK** to save and close the new configuration.

When you build the model, the software automatically erases, programs, and verifies Flash memory. When the DSP board restarts, it loads and executes the program from Flash memory.

Selectively Erase, Program, or Verify Specific Flash Sectors

You can manually erase, program, and verify specific sectors of Flash memory:

- 1 Open the Target Hardware Resources tab for your model, and select the **Peripherals** tab.
- 2 Select **Flash_loader** from the **Peripherals** list.
- 3 Set **Enable flash programmer** to erase, program, or verify flash.
- 4 (Optional) To protect specific Flash sectors:

- a** Disable **Detect Flash sectors to erase from COFF file**.
 - b** Clear the flash sectors you want to protect.
- 5** Click **Execute**. The software performs the action you specified upon the unprotected flash sectors.

Note Erase Flash sectors before programming them.

Placing Additional Code or Data on Unused Flash Sectors

To place additional code or data on unused Flash sectors:

- 1** Determine the address and length of the individual Flash sectors. You may need to refer to the manufacturer's specifications.
- 2** Determine the size of the primary C code program and the number of Flash sectors it occupies.
- 3** Determine the size of the additional code or data and the number of Flash sectors it will occupy.
- 4** Under the Target Hardware Resources tab, on the **Memory** tab, click **Add** to create two or more new memory banks; one for the primary C code program (e.g., FLASH_AB) and one or more for the additional code or data (e.g., FLASH_CD). The address and length of each memory bank must align with those of the flash sectors.

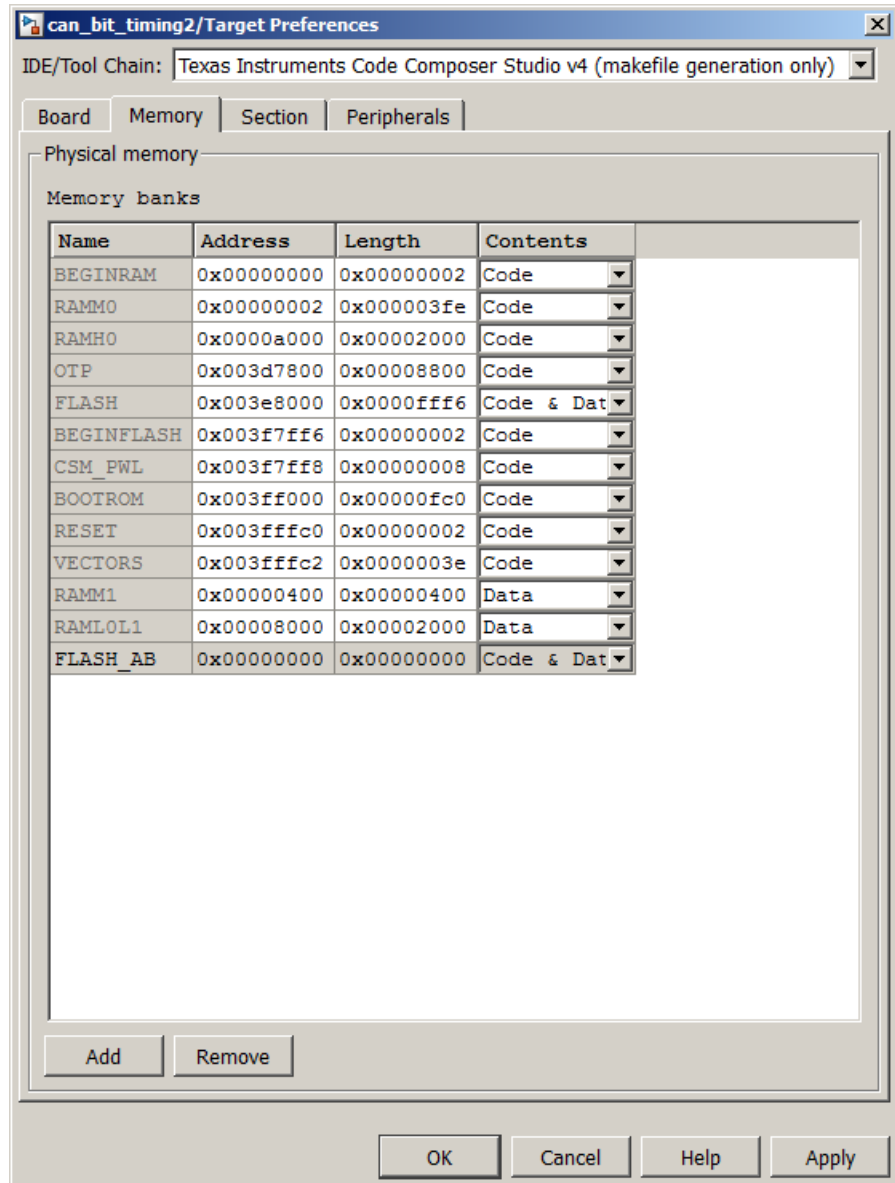

- Under the **Sections** tab, under **Default sections**, select **.text**. Then, under **Placement**, select the new memory bank (e.g., **FLASH_AB**) you created

for the primary C code program. The next time you program the Flash memory, the software places the `.text` C code file in the new memory bank.

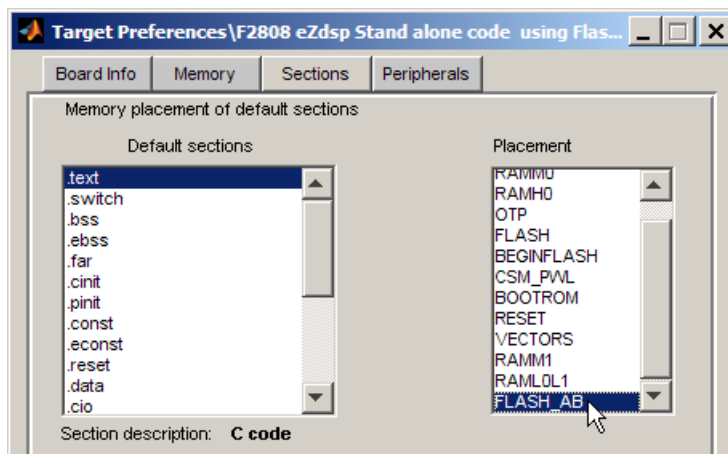

- 6 Similarly, select items from the **Default sections** or **Custom sections list**, and place them in the new memory banks (e.g., `FLASH_CD`) for the previously unoccupied Flash sectors.

Configuring LIN Communications

In this section...
“Overview” on page 44-105
“Configuring Your Model” on page 44-105

Overview

The LIN communications architecture supports a single master node and up to 16 slave nodes on a LIN network.

LIN nodes use message frames to exchange data. The message has two parts:

- Frame header, generated by the Master node.
- Frame response, which contains data generated by either Slave node or a slave task on a Master node (but not both).

Configuring Your Model

First, study, and understand the LIN addressing system. See the “Message Filtering and Validation” topic in the TMS320F2803x Piccolo Local Interconnect Network (LIN) Module, Literature Number: SPRUGE2A.

Configure the LIN node in your model as a master or slave node:

- 1** Configure the Target Hardware Resources tab, as described in “Configure Target Hardware Resources” on page 35-3.
- 2** In the Target Hardware Resources tab, select the **Peripherals** tab, and then select **LIN**.
- 3** Set **LIN mode** to **Master** or **Slave**.

If the LIN node is a Master node:

- Add a LIN Transmit block to the model. This block enables the Master to generate message headers.

- To send data, set the **ID** input and **Tx ID Mask** input to make Tx ID Match happen on this node.
- To receive data, place LIN Receive block in the model. Set the **Rx ID Mask** input to make Rx ID Match happen on this node.

For example, to configure a model with a master node that receives data from a slave node:

- Add a LIN Transmit block and a LIN Receive block to the model.
- In the Target Hardware Resources tab, configure the **ID Slave Task Byte**.
- For the LIN Transmit block, set the **ID** input.
- For the LIN Receive block, set the **Rx ID Mask** input so that: **Rx ID Mask = ID XOR Slave Task ID Byte**.

If the LIN node is a Slave node:

- To send data, place LIN Transmit block in the model. Set the **ID** input to match the LIN frame header issued by the remote Master. Set **Tx ID Mask** to make a Tx ID Match happen on this node.
- To receive data, place LIN Receive block in the model. Set the **Rx ID Mask** input to make an Rx ID Match happen on this node.

For example, to configure a model with a slave node that transmits data to a master node:

- Add a LIN Transmit block to the model.
- In the Target Hardware Resources tab, configure the **ID byte** or **ID Slave Task Byte** (depending on the **ID filtering** option).
- In the LIN Transmit block, set the **ID** input and **Tx ID Mask** input so that: **Tx ID Mask = ID XOR (ID Byte or ID Slave Task Byte)**.

Set the **Data type** and **Data length** values in your LIN Receive blocks to match the type and length of the transmitted data. These values enable the receive block reconstruct the data from the message frames.

Note The LIN Transmit block inherits the data type and length from its input.

Tips and Limitations

Texas Instruments C28x DMC Blocks Require CRL

Starting in R2011a, the following blocks removed processor-specific optimized code from Texas Instruments. To generate code that contains optimized code from TI for the following TI C28x DMC blocks, enable the TI C28x Code Replacement Library (CRL):

- C2000 Clarke Transformation
- C2000 Inverse Park Transformation
- C2000 Park Transformation
- C2000 PID Controller
- C2000 Ramp Generator
- C2000 Speed Measurement

The CRL code replacement library inserts optimized processor- and compiler-specific implementations of functions and arithmetic operators. See “About Code Replacement Libraries and Optimization” on page 37-2

Because the following blocks do not contain processor-specific code from Texas Instruments, they are hardware agnostic, and you can use them in a wide range of Simulink models:

- C2000 Clarke Transformation
- C2000 PID Controller
- C2000 Ramp Generator
- C2000 Speed Measurement

Working with Texas Instruments C6000 Processors

- “Getting Started” on page 45-2
- “Targeting C6000 DSP Hardware” on page 45-8
- “Targeting with DSP/BIOS Options” on page 45-64
- “Using the C62x and C64x DSP Libraries” on page 45-89
- “Configuring Timing Parameters for CAN Blocks” on page 45-98
- “Hardware Issues” on page 45-102

Getting Started

In this section...
“Feature Support for Code Composer Studio” on page 45-2
“Overview” on page 45-2
“Using This Guide” on page 45-3
“Configuration Information” on page 45-4
“Setting Up and Configuring” on page 45-4

Feature Support for Code Composer Studio

The “Working with Texas Instruments C6000 Processors” section of the User’s Guide contains some references to the IDE Automation Interface and IDE Project Generator components. Embedded Coder supports these two components with Code Composer Studio 3.3 (CCSv3). Embedded Coder does not support these components with Code Composer Studio 4 & 5 (CCSv4/5).

For more information, see “Working with Texas Instruments Code Composer Studio IDE”.

Overview

Product Description

Use Embedded Coder to deploy generated code for real-time execution on embedded microprocessors, microcontrollers, and DSPs. Using Embedded Coder, you can integrate peripheral devices with the algorithms created using MATLAB function blocks, Simulink®, and Stateflow®. You can deploy the resulting executable onto embedded hardware for on-target rapid prototyping, real-time performance analysis, and field production.

Using This Guide

Expected Background

This document introduces you to using Embedded Coder software to develop digital signal processing applications for the Texas Instruments C6000 family of DSP development hardware, such as the TI TMS320C6713 DSP Starter Kit. To get the most out of this manual, you should be familiar with MATLAB software and its associated programs, such as DSP System Toolbox software and Simulink software. We do not discuss details of digital signal processor operations and applications, except to introduce concepts related to using specific targets. For more information about digital signal processing, you may find one or more of the following books helpful:

- McClellan, J. H., R. W. Schafer, and M. A. Yoder, *DSP First: A Multimedia Approach*, Prentice Hall, 1998.
- Lapsley, P., J. Bier, A. Sholam, and E. A. Lee, *DSP Processor Fundamentals Architectures and Features*, IEEE® Press, 1997.
- Oppenheim, A.V., R. W. Schafer, *Discrete-Time Signal Processing*, Prentice-Hall, 1989.
- Mitra, S. K., *Digital Signal Processing — A Computer-Based Approach*, The McGraw-Hill Companies, Inc, 1998.
- Steiglitz, K, *A Digital Signal Processing Primer*, Addison-Wesley Publishing Company, 1996.

Refer to the documentation for your TI boards for information about setting them up and using them.

If You Are a New User. New users should read “Getting Started” on page 45-2, which introduces the Embedded Coder environment—the required software and hardware, installation requirements, and the board configuration settings that you need. You will find descriptions of the blocks associated with the targeting software, and an introduction to the range of digital signal processing applications of which the Embedded Coder is capable.

If You Are an Experienced User. Everyone should read “Targeting C6000 DSP Hardware” on page 45-8 for information and examples about using the new blocks and build software to target your C6713 DSK. Two example models introduce the targeting software and build files, and give you an idea of the range of applications supported by the Embedded Coder.

Configuration Information

To determine whether Embedded Coder software is installed on your system, type this command at the MATLAB prompt.

```
c6000lib
```

Entering that command displays the C6000 block library:

To verify that the CCSv3 IDE is installed on your machine, enter `ccsboardinfo`.

The command line responds with the current board information. For example:

```
>> ccsboardinfo
Board Board          Proc Processor      Processor
Num  Name          Num  Name          Type
---  -
0    C6713 Device Cycle Accurate Si ... 0    TMS320C6713      TMS320C6000
```

With the CCSv3 IDE installed and configured, the command line returns information about the boards that CCSv3 IDE recognizes on your machine, in a form similar to the preceding example.

If the command line does not return information about boards, revisit your CCSv3 IDE installation and setup in your CCSv3 IDE documentation.

As a final test, launch CCSv3 IDE to verify that it runs. For the Embedded Coder to operate with this application, the CCSv3 IDE must be able to run on its own.

Setting Up and Configuring

- “System Requirements” on page 45-5

- “Supported Hardware” on page 45-5
- “Installing and Configuring Software” on page 45-5

System Requirements

For detailed information about the software and hardware required to use Embedded Coder software, refer to the Embedded Coder system requirements areas on the MathWorks Web site:

- Requirements for Embedded Coder:
www.mathworks.com/products/target-package/requirements.html
- Requirements for use with TI's C6000:
www.mathworks.com/products/target-package/ti-adaptor/

Supported Hardware

For a list of supported hardware, visit
<http://www.mathworks.com/products/target-package/supportedio.html>.

Installing and Configuring Software

Consult the “System Requirements” on page 45-5 for Embedded Coder . Only use *supported versions* of the software listed under “Third-Party Embedded Coder Requirements”. Uninstall unsupported versions *before* installing supported versions. This prevents errors that occur when the Windows Environment Variables point to the unsupported versions.

The System Requirements describe where you can obtain the additional third-party software, and when available, provide links for downloading that software.

Before you install the software, if you are installing Texas Instruments (TI) Code Composer Studio CCSv3 on Windows 7, make sure that:

- You have administrator privileges.
- You have set the User Account Control (UAC) settings to the lowest level.
- You install CCSv3 in a folder other than Program Files.

Go to the vendor Web sites to find 64-bit compatible drivers for installing CCSv3 on 64-bit machine with drivers such as, Spectrum Digital Emulators or BlackHawk Emulators. Most vendors have 64-bit drivers that are compatible with CCSv3.

For the Host side CAN functionality, you must install 32-bit version of MATLAB on 64-bit machines.

Install the software in the following order:

- 1** Install the required and optional MathWorks software. The software license you purchase determines which products are available.
- 2** Install TI CCS.
- 3** Install TI Service Release for CCS.
- 4** Install the TI Code Generation Tools for you processor.
- 5** If you are using a Spectrum Digital board, download and install the matching Spectrum Digital Driver.
- 6** Install additional board-specific packages in the order in which they appear on the System Requirements web page.

Configure CCS as follows:

- 1** In CCS, open **Help > About > Component Manager > Build tools** .
- 2** Open each target hardware you will be using and enable the supported version of **Code Generation Tools**.
- 3** Open **Help > About > Component Manager > Build Tools > Target Content (DSP/BIOS)** .
- 4** Open each target hardware you will be using and enable the supported version of **Texas Instruments DSP/BIOS**.
- 5** In Component Manager, select Save the changes. Then exit and restart CCS.

- 6** If you have a Spectrum Digital DM6437EVM board and or an Avnet S3ADSP DM6437 board, refer to “Installing and Configuring the Avnet Board Support Library” on page 45-105.
- 7** Verify the installation by repeating the instructions in “Configuration Information” on page 45-4.

Targeting C6000 DSP Hardware

In this section...

“Introduction to Targeting” on page 45-8

“C6000 and Code Composer Studio IDE” on page 45-9

“Targeting — Single Rate Application” on page 45-12

“Schedulers and Timing” on page 45-19

“Model Reference and Embedded Coder Software” on page 45-29

“Targeting Supported Boards” on page 45-33

“Simulink Models and Targeting” on page 45-38

“Targeting — A More Complex Application” on page 45-38

“Targeting Your C6713 DSK and Other Hardware” on page 45-44

“Creating Code Composer Studio Projects Without Building” on page 45-47

“Targeting Custom Hardware” on page 45-49

“Using Embedded Coder Software” on page 45-62

Introduction to Targeting

Overview

The Embedded Coder software lets you use Simulink Coder software to generate a C language real-time implementation of your Simulink model. You can compile, link, download, and execute the generated code on the C6713 DSP Starter Kit (DSK). The Embedded Coder is ideal for rapid prototyping and developing embedded systems applications for C6713 digital signal processors. The Embedded Coder focuses on developing real-time digital signal processing (DSP) applications for C6000 hardware. Additional hardware that we support is listed in “Hardware Issues” on page 45-102.

Although the tutorials in this chapter focus on the C6713 DSK, the techniques and processes apply to supported hardware, with minor adjustments for the processor involved.

This chapter describes how to use the Embedded Coder to create and execute applications on Texas Instruments C6000 development boards. To use the targeting software, you should be familiar with using Simulink software to create models and with the basic concepts of Simulink Coder software automatic code generation. To read more about Simulink Coder software, refer to your Simulink Coder documentation.

This chapter frequently uses the C6713 DSK as a hardware example. You can apply the tutorials, concepts, and procedures to other supported C6000 processors and boards.

Later sections discuss the Embedded Coder software and targeting custom hardware.

Tip To make your figure easier to read, use easily distinguishable colors and line styles.

C6000 and Code Composer Studio IDE

- “Using Code Composer Studio with Embedded Coder Software” on page 45-9
- “About Simulators” on page 45-10
- “Typical Hardware Setup for a Development Board” on page 45-11

Using Code Composer Studio with Embedded Coder Software

Texas Instruments (TI) markets a complete set of software tools to use when you develop applications for your C6000 hardware boards. This section provides a brief example of how Embedded Coder software uses Code Composer Studio (CCS) Integrated Development Environment (IDE) with the Simulink Coder software and the c6000lib blockset.

Executing code generated from Simulink Coder software on a particular target in real time requires that Simulink Coder software generate target code that is tailored to the specific hardware target. Target-specific code includes I/O device drivers and an interrupt service routine (ISR). Since these device

drivers and ISRs are specific to particular hardware targets, you must check that the target-specific components are compatible with the target hardware.

To allow you to build an executable, TI C6000 uses the MATLAB links in Embedded Coder software to invoke the code building process within the CCSv3 IDE. After you download your executable to your target and run it, the code runs wholly on the target; you can access the running process only from the CCS IDE debugging tools. Otherwise the running process is not accessible.

Used in combination with your Embedded Coder and Simulink Coder software, TI products provide an integrated development environment that, once installed, does not need additional coding.

About Simulators

The CCS IDE offers simulators for the C6000 processors in the CCS IDE Setup utility. Much of your model and algorithm development efforts work with the simulators, such as code generation. And, since the Embedded Coder provides a software-based scheduler, your models and generated code run on the simulators just as they do on your hardware. For more information about the simulators in CCS IDE, refer to your CCS online help system.

When you set up a simulator, match the processor on your target exactly to simulate your target hardware. For example, to target a C6713DSK board, your simulator must contain a C6713 processor, not just a C6xxx simulator. Simulators must match the target hardware because the codecs on the board are not the same and the simulator needs to identify the codec. Choosing the simulator that corresponds to your hardware matches the memory maps and registers with your target hardware.

To use a simulator, open the Target Hardware Resources tab in the model Configuration Parameters dialog. Then, on the **Board** pane, under **IDE Support**, use the **Get from IDE** button to get a list of simulators installed with your IDE. Then use the **Board Name** parameter to select one of the installed simulators.

In general, use the device cycle accurate simulators provided by CCS Setup to simulate your processor.

Typical Hardware Setup for a Development Board

The following block diagram represents typical inputs and output for a C6713 DSK development board.

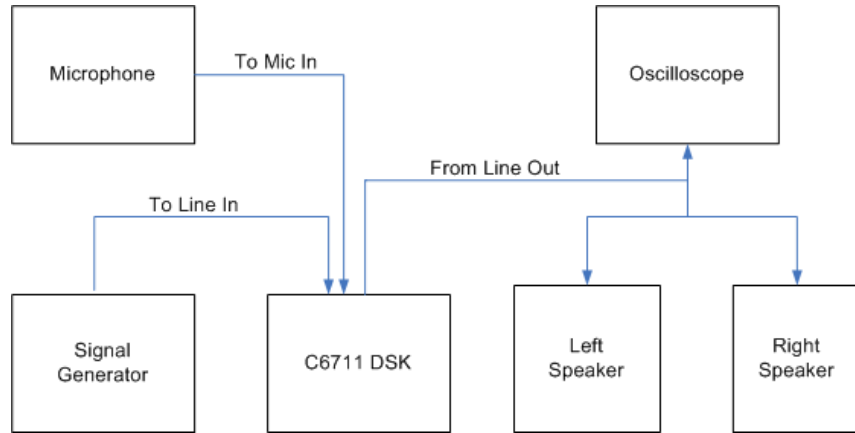

After installing a supported development board, start MATLAB software. At the command prompt, type `c6000lib`. This opens a Simulink blockset named `c6000lib` that includes libraries that contain blocks predefined for C6000 input and output devices.

The board-based block library for the C6713 DSK contains these blocks:

- ADC block
- DAC block
- DIP Switch block (optional, refer to the reference page for the DIP Switch block for your target)
- LED block
- Reset block

Blocks from these libraries are associated with your boards and hardware. As required, add the devices to your model. If you choose not to include either an ADC or DAC block in your model (they are available in the target specific libraries), the Embedded Coder provides a timer that produces the interrupts

required for timing and running your model, either on your hardware target or on a simulator.

Targeting – Single Rate Application

- “Overview” on page 45-12
- “Building the Audio Reverberation Model” on page 45-13
- “Adding C6713 DSK Blocks to Your Model” on page 45-14
- “Configuring Embedded Coder Blocks” on page 45-15
- “Specifying Configuration Parameters for Your Model” on page 45-16

Overview

In this tutorial you create and build a model that simulates audio reverberation applied to an input signal. Reverberation is similar to the echo you can hear when you shout across an open valley or canyon, or in a large empty room.

You can choose to create the Simulink model for this tutorial from blocks in DSP System Toolbox software and Simulink block libraries, or you can find the model in Embedded Coder examples. For this example, you see the model as it appears in the example program. The example model name is `c6713dskafxr` as shown in the next figure. Open this model by entering `c6713dskafxr` at the MATLAB prompt.

To run this model you need a microphone connected to the **Mic In** connector on your C6713 DSK, and speakers and an oscilloscope connected to the **Line Out** connector on your C6713 DSK. To test the model, speak into the microphone and listen to the output from the speakers. You can observe the output on the oscilloscope as well.

To download and run your model on your C6713 DSK, complete the following tasks:

- 1 Use Simulink blocks, DSP System Toolbox software blocks, and blocks from other blocksets to create your model application.

- 2** Add Embedded Coder blocks that let your signal sources and output devices communicate with your C6713 DSK—the C6713 DSK ADC and C6713 DSK DAC blocks that you find in Embedded Coder c6000lib blockset.
- 3** Configure your model as described in “Configure Target Hardware Resources” on page 35-3.
- 4** If you are using a C6713 simulator, use the **Get from IDE** button on the **Board** pane, located on the Target Hardware Resources pane in the Model Configuration Parameters. Then, set **Board Name** under **IDE Support** to **C6713 Device Cycle Accurate Simulator**.
- 5** Set the Configuration Parameters for your model, including
 - Solver parameters such as simulation start and solver options
 - Software options such as target configuration and target compiler selection
- 6** Build your model to the selected target hardware.
- 7** Test your model running on the target by changing the input to the target and observing the output from the target hardware.

Your target for this tutorial is your C6713 DSK installed on your PC. Be sure to configure and test your board as directed in “Configuring Your C6713DSK” on page 45-36 in this guide before continuing this tutorial.

Building the Audio Reverberation Model

To build the model for audio reverberation, follow these steps:

- 1** Start Simulink.
- 2** Create a new model by selecting **File > New > Model** from the **Simulink** menu bar.
- 3** Use Simulink blocks and DSP System Toolbox software blocks to create the following model.

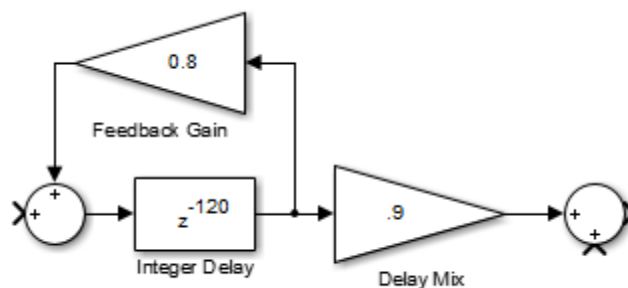

Look for the Delay block in the Signal Operations library of the DSP System Toolbox software. You do not need to add the input and output signal lines at this time. When you add the C6713 DSK blocks in the next section, you add the input and output to the sum blocks.

4 Name and save your model before continuing.

Adding C6713 DSK Blocks to Your Model

So that you can send signals to your C6713 DSK and get signals back from the board, Embedded Coder software includes a block library containing five blocks designed to work with the codec on your C6713 DSK:

- Input block (C6713 DSK ADC)
- Output block (C6713 DSK DAC)
- Light emitting diode block (C6713 DSK LED)
- Software reset block (Reset C6713 DSK)
- DIP switch block (C6713 DSK DIP Switch)

Entering `c6713dsklib` at the MATLAB prompt opens the block library for the C6713 DSK. This block library is included in Embedded Coder `c6000lib` blockset in the Simulink Library browser.

The C6713 DSK ADC and C6713 DSK DAC blocks generate code that configures the codec on your C6713 DSK to accept input signals from the input connectors on the board, and send the model output to the output connector

on the board. Essentially, the C6713 DSK ADC and C6713 DSK DAC blocks add driver software that controls the behavior of the codec for your model.

To add C6713 DSK target blocks to your model, follow these steps:

- 1** Double-click Embedded Coder software in the Simulink Library browser to open the c6000lib blockset.
- 2** Click the block library for the C6713 DSK to see the blocks available for your C6713 DSK.
- 3** Drag and drop C6713 DSK ADC and C6713 DSK DAC blocks to your model as shown in the figure.

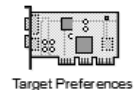
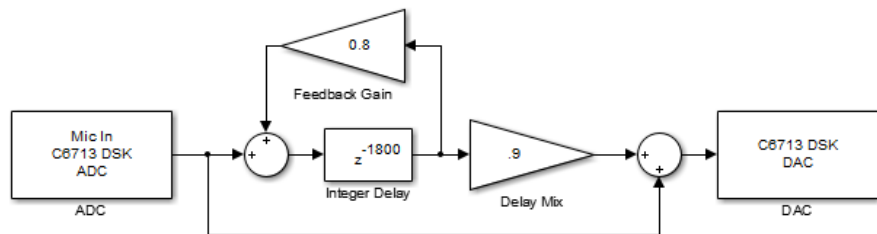

- 4** Connect new signal lines as shown in the figure.
- 5** Configure your model as described in “Configure Target Hardware Resources” on page 35-3.

Configuring Embedded Coder Blocks

To configure Embedded Coder blocks in your model, follow these steps:

- 1** Click the C6713 DSK ADC block to select it.
- 2** Select **Block Parameters** from the Simulink **Edit** menu.

3 Set the following parameters for the block:

- Clear the **Stereo** check box.
- Select the **+20 dB mic gain boost** check box.
From the list, set **Sample rate** to 8000.
- Set **Codec data format** to 16-bit linear.
- For **Output data type**, select Double from the list.
- Set **Scaling** to Normalize.
- Set **Source gain** to 0.0.
- Enter 64 for **Samples per frame**.

Include a signal path directly from the input to the output so you can display both the input signal and the modified output signal on the oscilloscope for comparison.

4 For **C6713 DSK ADC source**, select Mic In.

5 Click **OK** to close the C6713 DSK ADC dialog.

6 Now set the options for the C6713 DSK DAC block.

- Set **Codec data format** to 16-bit linear.
- Set **Scaling** to Normalize.
- For **DAC attenuation**, enter 0.0.
- Set **Overflow mode** to Saturate.

7 Click **OK** to close the dialog.

You have completed the model. Now configure the Simulink Coder software options to build and download your new model to your C6713 DSK.

Specifying Configuration Parameters for Your Model

The following sections describe how to build and run real-time digital signal processing models on your C6713 DSK. Running a model on the target starts with configuring and building your model from the Configuration Parameters dialog in Simulink software.

Setting Simulink Configuration Parameters. After you have designed and implemented your digital signal processing model in Simulink software, complete the following steps to set the Configuration Parameters for the model:

- 1 Open the Configuration Parameters dialog and set the right options on the **Solver** category for your model and for Embedded Coder software.
 - Set **Start time** to 0.0 and **Stop time** to `inf` (model runs without stopping). Generated code does not honor this setting if you set a stop time. Set this to `inf` for completeness.
 - Under **Solver options**, set **Type** to `fixed-step` and set **Solver** to `discrete` (no continuous states). For PIL, set **Type** and **Solver** to any setting.
 - For **Fixed step size (fundamental sample time)**, enter `Auto`, and set **Tasking mode for periodic sample times** to `SingleTasking`.

Note Generated code does not honor Simulink stop time from the simulation. Stop time is interpreted as `inf`. To implement a stop in generated code, you must put a Stop Simulation block in your model.

Ignore the **Data Import/Export**, **Diagnostics**, and **Optimization** panes in the Configuration Parameters dialog. The default settings are right for your new model.

Setting Simulink Coder Target Build Options. Configure Simulink Coder software to generate and build code for the C6713 DSK:

- 1 Open the Configuration Parameters dialog by pressing **Ctrl+E** or by selecting **Simulation > Model Configuration Parameters**.
- 2 Select the **Code Generation** pane.
- 3 Verify that the system target file is set to `idmlink_grt.tlc`.
- 4 Expand the node for the Code Generation pane. Then select the **Coder Target** pane.

- 5 Among the **Run-Time** options, set **Build action** to **Build_and_execute**, and set **Interrupt overrun notification method** to **Print_message**.
- 6 Among the **Vendor Tool Chain**, keep the default settings.
- 7 Among the **Code Generation** options, clear **Profile real-time execution**.
- 8 Among the **Link Automation** options, verify that **Export Coder Target handle to base workspace** is selected and that **Coder Target handle name** has a name (e.g., **IDE_Obj**).
- 9 In the Configuration Parameters dialog, select the **Hardware Implementation** pane.
- 10 Verify that **Byte ordering** is **Little endian**.

When you have completed these steps, you have configured the Configuration Parameters for the C6713 DSK target. Some of the panes under the Code Generation pane, such as **Comments** and **Symbols**, do not require configuration. The default values for the options in these panes are already right for your new model. For other models, you may want to set the options in these panes to provide information during the build and to run TLC debugging when you generate code.

Building and Executing Your Model on Your C6713 DSK. After you set the Configuration Parameters and configure Simulink Coder software to create the files you need, you direct Simulink Coder software to build, download, and run your model executable on your target:

- 1 Change the category to **Code Generation** on the Configuration Parameters dialog.
- 2 Clear **Generate code only** and click **Build** to generate and build an executable file targeted to your C6713 DSK.

When you click **Build** with **Build_and_execute** selected for **Build action**, the automatic build process creates an executable file that can be run by the C6713 DSP on your C6713 DSK, and then downloads the executable file to the target and runs the file.

- 3** To stop-model execution, click the **Reset C6713 DSK** block or use the **Halt** option in CCS IDE. You could type halt from the MATLAB command prompt as well.

Testing Your Audio Reverb Model. With your model running on your C6713 DSK, speak into the microphone you connected to the board. The model should generate a reverberation from of the speakers, delaying and echoing the words you speak into the mike. If you built the model yourself, rather than using the supplied model `c6713dskafxr`, try running the example model to compare the results.

Schedulers and Timing

- “Timer-Based Versus Asynchronous Interrupt Processing” on page 45-19
- “Synchronous Scheduling” on page 45-20
- “Asynchronous Scheduling” on page 45-21
- “Using Asynchronous Scheduler” on page 45-22
- “Uses for Asynchronous Scheduling” on page 45-23
- “Scheduling Considerations” on page 45-28

Timer-Based Versus Asynchronous Interrupt Processing

Code generated for periodic tasks, both single- and multitasking, runs out of the context of a timer interrupt. The generated code that represents model blocks for periodic tasks runs periodically, clocked by the periodic interrupt whose period is equal to the base sample time of the model. This description of scheduling and timing applies both to generated code operation that incorporates DSP/BIOS real-time operating system (RTOS) and basic code generation mode where DSP/BIOS RTOS is not included.

Note In timer-based models, the timer counts through one full base-sample-time before it creates an interrupt. When the model is finally executed, it is for time 0.

This execution scheduling scheme is not flexible enough for some systems, such as control and communication systems that must respond to asynchronous events in real time. Such systems may need to handle a variety of hardware interrupts in an asynchronous, or aperiodic, fashion.

When you plan your project or algorithm, select your scheduling technique based on your application needs.

If your application processes hardware interrupts asynchronously, add the right asynchronous scheduling blocks from the Texas Instruments C6000 **DSP/BIOS** (dspbioslib) and **Scheduling** (c6000dspcorelib) block libraries to your model.

If your application does not service asynchronous interrupts, your model should include only the algorithm and device driver blocks that specify the periodic sample times. Generating code from a model like this automatically enables and manages a timer interrupt. The periodic timer interrupt clocks the entire model.

Synchronous Scheduling

For code that runs synchronously in the context of the timer interrupt, each iteration of the model runs after an interrupt has been posted and serviced by an interrupt service routine (ISR). The code generated for Embedded Coder software uses Timer 1 in DSP/BIOS mode and bare-board mode. Timer 1 is configured so that the base rate sample time for the coded process corresponds to the interrupt rate. The Embedded Coder calculates and configures the timer period to produce the desired sample rate.

The minimum achievable base rate sample time depends on the algorithm complexity and the CPU clock speed. The maximum value depends on the maximum timer period value and the CPU clock speed.

If the blocks in the model inherit their sample time value, and a sample time is not defined explicitly, Simulink assigns a default sample time of 0.2 second.

Note In timer-based models, the timer counts through one full base-sample-time before it creates an interrupt. When the model is finally executed, it is for time 0.

Asynchronous Scheduling

Embedded Coder software facilitates modeling and automatically generating code for asynchronous systems by using the following scheduling blocks:

- Hardware Interrupt and Idle Task blocks for bare-board code generation mode
- DSP/BIOS Hardware Interrupt, DSP/BIOS Task, and DSP/BIOS Triggered Task blocks for DSP/BIOS code generation mode

C6000 Hardware Interrupt blocks enable selected hardware interrupts for the TI TMS320C6000 DSP, generate corresponding ISRs, and connect them to the corresponding interrupt service vector table entries.

When you connect the output of the C6000 Hardware Interrupt block to the control input of a function-call subsystem, the generated subsystem code is called from the ISRs each time the interrupt is raised.

The C6000 Idle Task block specifies one or more functions to execute as background tasks in the code generated for the model. The functions are created from the function-call subsystems to which the Idle Task block is connected.

The DSP/BIOS Hardware Interrupt block (in DSP/BIOS code generation mode) has the same functionality as the bare-board C6000 Hardware Interrupt block. The configuration and low-level handling of the hardware interrupts is implemented through DSP/BIOS using DSP/BIOS Hardware Interrupt module and DSP/BIOS dispatcher.

DSP/BIOS Task blocks (DSP/BIOS code generation mode) spawn free-running tasks as separate DSP/BIOS threads. The spawned task runs the function-call subsystem connected to its output. Blocks in the subsystem may use various conditions and techniques to control sharing sources with other tasks.

DSP/BIOS Triggered Task blocks (in DSP/BIOS code generation mode) spawn semaphore-controlled tasks as separate DSP/BIOS threads. The semaphore that enables execution of a single instance of the task is posted by an ISR that is created by a DSP/BIOS Hardware Interrupt block. This block is connected to a DSP/BIOS Triggered Task block.

Using Asynchronous Scheduler

Now you can use an asynchronous (real-time) scheduler for your target application. Earlier versions of Embedded Coder software used a synchronous CPU timer interrupt-driven scheduler. With the asynchronous scheduler you can define interrupts and tasks to occur when you want them to using blocks in the following libraries:

- C6000 Scheduler
- DSP/BIOS library (dspbioslib)

Also, you can schedule multiple tasks for asynchronous execution using those blocks libraries.

The example models for Wavelet Denoising use the asynchronous scheduler rather than the synchronous scheduler.

Wavelet Denoising

C6713 DSK

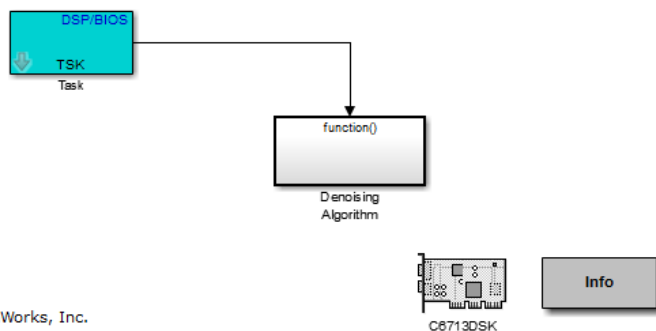

Copyright 2003-2012 The MathWorks, Inc.

Uses for Asynchronous Scheduling

The following sections present common cases for the scheduling blocks described in the previous sections.

Free-Running DSP/BIOS Task. The following model illustrates a case where a reverberation algorithm runs in the context of a free-running DSP/BIOS task.

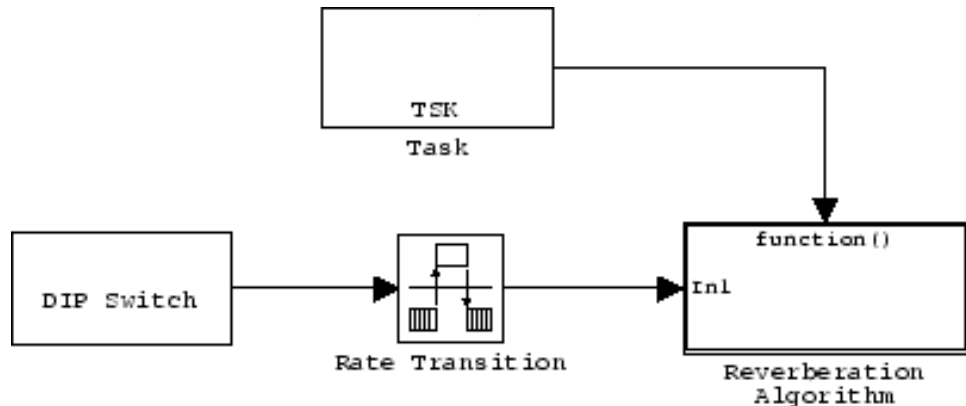

Normally, the algorithms in this type of task run in free-running mode, that is, they run repetitively and indefinitely. However, in this function-call subsystem (shown in detail in the following figure), ADC and DAC blocks suspend the execution of the task until the ADC and DAC data is available.

Each instance of the reverberation algorithm is triggered only after the data buffer is available (for both ADC and DAC). An asynchronous ADC/DAC device driver layer separate from the task function manages the triggers condition. This device driver layer uses a direct memory access (DMA) interrupt to signal to the DSP/BIOS task when ADC and DAC data become available for the task function.

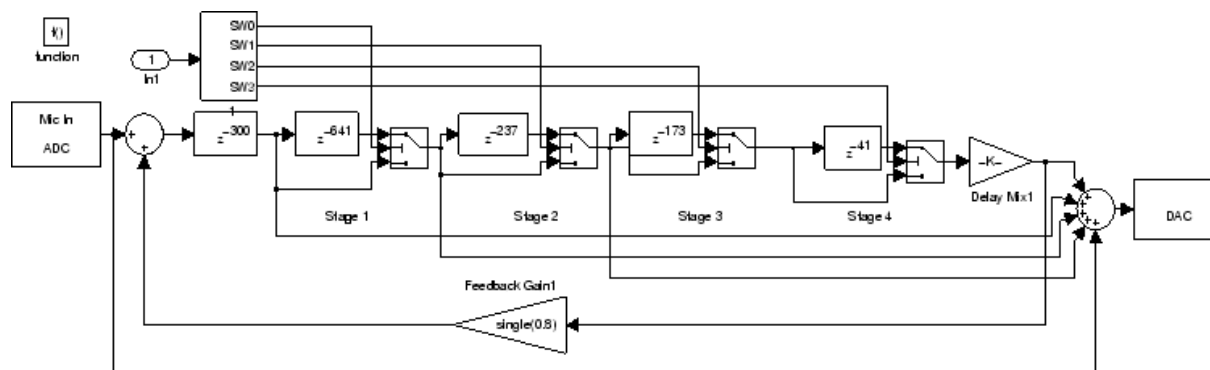

This model also illustrates how synchronous and asynchronous tasks can work together. The code generated for C6416 DSK DIP Switch block runs as a periodic task at the rate of 0.01 s. This is the only periodic task in the model. It runs out of the context of a DSP/BIOS task scheduled via a timer interrupt configured to go off every 0.01 second.

In general, Simulink blocks that specify nonzero sample rates, such as the DIP Switch block, are scheduled by the C6000 synchronous scheduler and executed either from the context of a DSP/BIOS task (if you incorporate DSP/BIOS in your project) or a hardware interrupt (when you do not incorporate DSP/BIOS).

For data integrity, Simulink Rate Transition blocks connect the C6416 DSK DIP Switch block with the reverberation algorithm. This transition is required because the blocks belong to different rate groups. If the synchronous and asynchronous parts of the model do not interact, the Rate Transition blocks are not required.

Idle Task. The following model illustrates a case where the reverberation algorithm runs in the context of a background task in bare-board code generation mode.

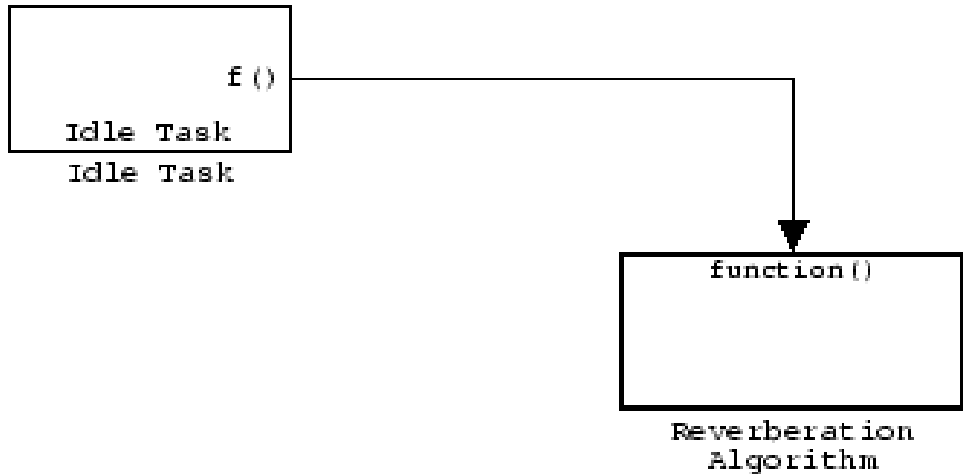

The function generated for this task normally runs in free-running mode—repetitively and indefinitely. However, the ADC and DAC blocks in this subsystem run in blocking mode. As a result, subsystem execution of the reverberation function is the same as the subsystem described for the Free-Running DSP/BIOS Task. It is data driven via a background DMA interrupt-controlled ISR, shown in the following figure.

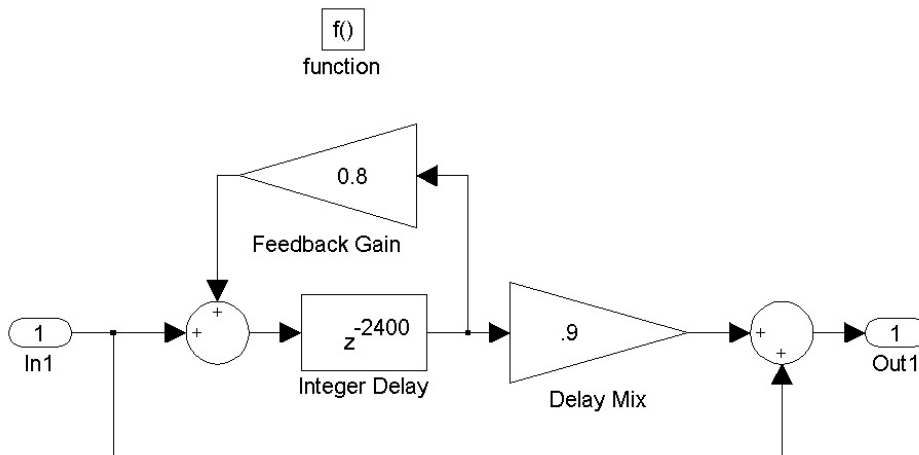

Hardware Interrupt Triggered DSP/BIOS Task. The next model illustrates a case where a function (Location Command) runs in the context of a hardware interrupt-triggered DSP/BIOS task.

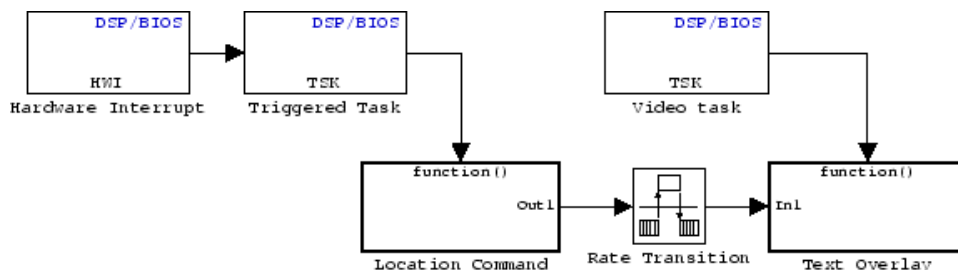

The DSP/BIOS Hardware Interrupt block installs an ISR function that signals a DSP/BIOS task to run when the ISR detects an RTDX interrupt. Signaling between the ISR and DSP/BIOS triggered task occurs via semaphores. This task receives an RTDX message carrying the location command for the downstream Text Insert block in the Text Overlay from the host computer.

The blocks running inside the Location Command and Text Overlay subsystems are shown in the following figure.

The text overlay subsystem is executed as for the Free-Running DSP/BIOS Task. For data integrity, a Rate Transition block connects the two subsystems that run at two different asynchronous rates. The execution of two asynchronous rates is ordered based on the priority settings for the DSP/BIOS Task blocks.

Location Command Subsystem

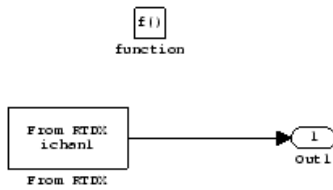

Text Overlay Subsystem

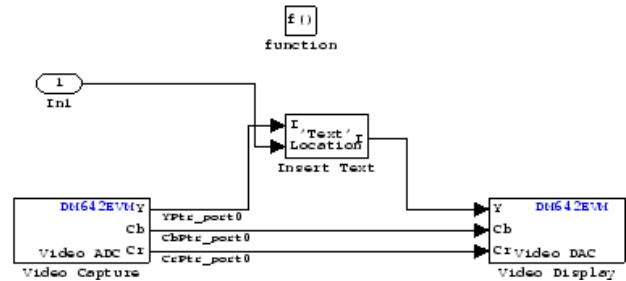

Hardware Interrupt Triggered Task. In the next figure, you see a case where a function (LED Control) runs in the context of a hardware interrupt triggered task.

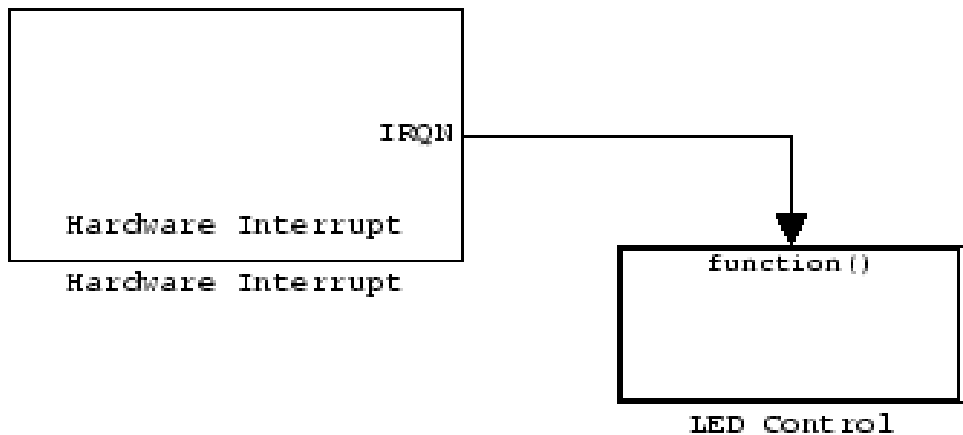

In this model, the C6000 Hardware Interrupt block installs a task that runs when it detects an external interrupt. This task then toggles an external C6416DSK LED on or off.

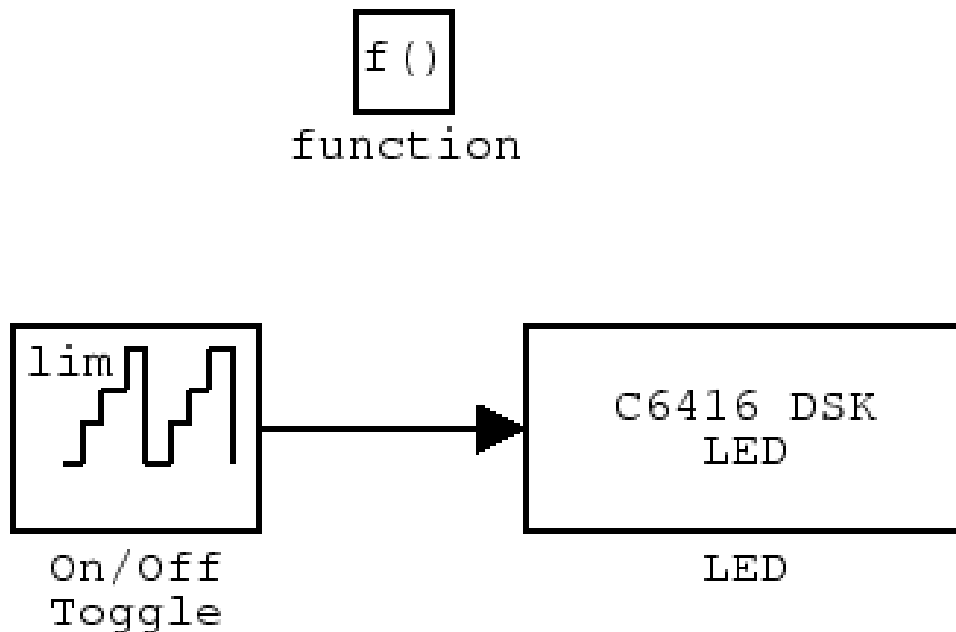

Scheduling Considerations

When you use the DSP/BIOS task blocks for scheduling, either the DSP/BIOS Task block or the DSP/BIOS Triggered Task block, you must take care to avoid some common scheduling pitfalls.

First, the DSP/BIOS operating system executes the task with the highest priority. Contrast this execution scheme with that of some other real-time operating systems (RTOS) where each task gets its fair share of processing time. Therefore, depending on the situation, there may be cases where lower-priority tasks do not execute because a higher priority task is not blocked.

A DSP/BIOS task blocks only when a blocking device driver block is included in the function call subsystem the task is executing, such as ADC/DAC blocks and C6000 UDP Receive blocks. If a particular DSP/BIOS task executes a function call subsystem that does not include device driver blocks, and this particular task has the highest priority, it does not release the CPU, effectively disabling the other lower priority tasks in the application.

For more information about asynchronous schedulers, refer to the “Handle Asynchronous Events” chapter in your Simulink Coder documentation in the online help system.

Model Reference and Embedded Coder Software

- “Overview” on page 45-29
- “How Model Reference Works” on page 45-29
- “Using Model Reference with Embedded Coder Software” on page 45-30
- “Configuring Targets to Use Model Reference” on page 45-32

Overview

Model reference lets your model include other models as modular components. This technique provides useful features because it:

- Simplifies working with large models by letting you build large models from smaller ones, or even large ones.
- Lets you generate code for the modules in the model, and later, regenerate code for modules that change.
- Lets you develop the modules independently.
- Lets you reuse modules and models by reference, rather than including the model or module multiple times in your model. Also, multiple models can refer to the same model or module.

Your Simulink Coder documentation provides much more information about model reference.

How Model Reference Works

Model reference behaves differently in simulation and in code generation. For this discussion, you need to know the following terms:

- Top-model — The root model block or model. It refers to other blocks or models. In the model hierarchy, this is the topmost model.

- Referenced models — Blocks or models that other models reference, such as models the top-model refers to. The models or blocks below the top-model in the hierarchy are reference models.

The following sections describe briefly how model reference works. More details are available in your Simulink Coder documentation in the online help system.

Model Reference in Simulation. When you simulate the top-model, Simulink Coder software detects that your model contains referenced models. Simulink generates code for the referenced models and uses the generated code to build shared library files for updating the model diagram and simulation. It also creates an executable (a MEX file, `.mex`) for each reference model that is used to simulate the top-model.

When you rebuild reference models for simulations or when you run or update a simulation, Simulink software rebuilds the model reference files. Whether reference files or models are rebuilt depends on:

- Whether and how you change the models.
- The **Rebuild** parameter on the **Model Reference** pane in the Configuration Parameters dialog.

Model Reference in Code Generation. Simulink Coder software requires executables to generate code from models. If you have not simulated your model at least once, Simulink Coder software creates a `.mex` file for simulation.

Now, for each referenced model, the code generation process calls `make_rtw` and builds each referenced model. This build process creates a library file for each of the referenced models in your model.

After building the referenced models, Simulink Coder software calls `make_rtw` on the top-model, linking to the library files it created for the associated referenced models.

Using Model Reference with Embedded Coder Software

With few limitations or restrictions, the Embedded Coder provides full support for generating code from models that use model reference.

Build Action Setting. The most important requirement for using model reference with the TI targets is to set the **Build action** for the Model blocks in the simulation to `Archive_library`.

To set the build action

- 1 Open your model.
- 2 Select **Simulation > Model Configuration Parameters** from the model menus.

The Configuration Parameters dialog opens.

- 3 Expand the node for the Code Generation pane. Then select the **Coder Target** pane.
- 4 In the right pane, under **Run-Time**, set **Build action** to `Archive_library`.

If your top-model uses a reference model that does not have the build action set to `Archive_library`, the build process automatically changes the build action to `Archive_library` and issues a warning about the change.

As a result of selecting the `Archive_library` setting, other options are disabled:

- DSP/BIOS is disabled for the referenced models. Only the top-model supports DSP/BIOS operation.
- **Overrun action**, **Overrun notification method**, **Exporting CCS object to the workspace**, and **Stack size** are the disabled for the referenced models.

Other Block Limitations. Model reference with Embedded Coder software does not allow you to use the following blocks or S-functions in reference models:

- Blocks from the C62x DSP Library (`tic64dsp1lib`) (because these are noninlined S-functions)
- Blocks from the C64x DSP Library (`tic62dsp1lib`) (because these are noninlined S-functions)

- Noninlined S-functions
- Driver blocks, such as the ADC or DAC blocks from an Embedded Coder library

Configuring Targets to Use Model Reference

Targets that you plan to use in Model Referencing must meet some general requirements.

- A model reference compatible target must be derived from the ERT or GRT targets.
- When you generate code from a model that references another model, you need to configure both the top-level model and the referenced models for the same code generation target.
- The External mode option is not supported in model reference Simulink Coder target builds. Embedded Coder software supports External mode, but not with model reference. If you select this option, it is ignored during code generation. For more information, please see the “Host/Target Communication” chapter in the Simulink Coder User’s Guide.
- To support model reference builds, your TMF must support use of the shared utilities folder, as described in Supporting Shared Utility folders in the Build Process.

To use an existing target, or a new target, with Model Reference, you set the `ModelReferenceCompliant` flag for the target hardware. For information on how to set this option, refer to `ModelReferenceCompliant` in the online help system.

If you start with a model that was created prior to version 2.4 (R14SP3), to make your model compatible with the model reference target, use the following command to set the `ModelReferenceCompliant` flag to On:

```
set_param(bdroot, 'ModelReferenceCompliant', 'on')
```

Models that you target with the Embedded Coder versions 2.4 and later automatically include the model reference capability. You do not need to set the flag.

Targeting Supported Boards

- “Overview” on page 45-33
- “Typical Targeting Process” on page 45-34
- “Targeting the C6713 DSP Starter Kit” on page 45-34
- “Configuring Your C6713DSK” on page 45-36
- “Confirming Your C6713DSK Installation” on page 45-37

Overview

Texas Instruments markets a complete set of tools for you to use with the a range of development boards, such as the C6713 DSK. These tools are primarily intended for rapid prototyping of control systems and hardware-in-the-loop applications. This section provides a brief example of how to use TI development tools with Simulink Coder software and the C6713 DSK blocks.

Executing code generated from Simulink Coder software on a particular target in real time requires target-specific code. Target-specific code includes I/O device drivers and an interrupt service routine. Other components, such as Embedded Coder software, are required if you need the ability to download parameters on the fly to your target hardware.

Since these components are specific to particular hardware targets (in this case, the C6713 DSK), you must check that the target-specific components are compatible with the target hardware.

To allow you to build an executable, Embedded Coder software provides a target makefile specific to the evaluation module. This target makefile invokes the optimizing compiler, provided as part of TI Code Composer Studio software.

Used in combination with Simulink Coder software, TI products provide an integrated development environment that, once installed, does not need additional coding.

Typical Targeting Process

Generally, targeting hardware, or a development environment as some call it, requires that you complete a series of processes that starts with building your model and ends with generating code to suit your target hardware.

- 1 Build the Simulink model of your algorithm or process to be converted to code for your target hardware.
- 2 Add target-specific blocks to your model, such as ADC and DAC blocks, and configure the block parameters.
- 3 Configure your model as described in “Configure Target Hardware Resources” on page 35-3.
- 4 Configure the options on the Target Hardware Resources pane to select the target, map memory segments, allocate sections to the memory segments, and configure other target-specific options.
- 5 Build your model to your target hardware.

Targeting the C6713 DSP Starter Kit

After you install the C6713 DSK development board and supporting TI products on your PC, start the MATLAB software. At the MATLAB command prompt, enter `c6713dsklib`. This opens a Simulink block library, `c6713dsklib`, that includes a set of blocks for C6713 DSK I/O devices, as described in the following table.

Block	Description
C6713 DSK ADC	Configure the analog to digital converter
C6713 DSK DAC	Configure the digital to analog converter
C6713 DSK LED	Control the user status LEDs on the C6713 DSK
C6713 DSK Reset	Reset the processor on the C6713 DSK

These blocks are associated with your C6713 DSK board. As required, add the blocks to your model.

With your model open, select **Simulation > Model Configuration Parameters**. From the Configuration Parameters dialog, select the **Code Generation** pane. Use the Code Generation pane to select the right **System target file** for your embedded processor. For the C6713 DSK, in the **Code Generation** pane, specify **System target file** —`idelink_grt.tlc`

With this configuration, you can generate a real-time executable and download it to the TI C6713 evaluation board. You generate the executable by clicking **Build** on the **Code Generation** pane. The Simulink Coder software automatically generates C code and inserts the I/O device drivers as specified in your block diagram. These device drivers are inserted in the generated C code as inlined S-functions. Inlined S-functions offer speed advantages and simplify the generated code. For more information about inlining S-functions, refer to Target Language Compiler Reference documentation. For a complete discussion of S-functions, refer to your Writing S-Functions documentation.

During the same build operation, the software invokes the TI compiler to build an executable file. If you select the `Build_and_execute` option, Simulink Coder software automatically downloads the executable to the TI evaluation board via the peripheral component interface (PCI) bus. After downloading the executable file to the C6713 DSK, the build process runs the file on the processor.

Starting and Stopping DSP Applications on the C6713 DSK. When you generate code, build the project, and download the code for your Simulink model to your C6713 DSK, you are running actual machine code corresponding to the block diagram you built in Simulink software. To start running your DSP application on the evaluation module, you must open your Simulink model and rebuild the machine executable by clicking **Build**. To start the application on the C6713 DSK, you use Simulink Coder software to rebuild the executable from the Simulink model and download the code to the board.

Your model runs until it encounters one of the following actions:

- You select **Debug > Halt** in CCS IDE.
- You shut down the host PC.
- The process encounters a Stop block in the model code.

- The running application encounters an error condition that stops the process.

If you included a Reset C6713 DSK block in your model, clicking the block stops the running application and restores the digital signal processor to its initial state.

Note When you build and execute a model on the C6713 DSK, the Simulink Coder build process resets the evaluation module automatically. You do not need to reset the board before building models. To stop processes that are running on the evaluation module, or to return the board to a known state, use the Reset C6713 DSK block.

Configuring Your C6713DSK

When you install the C6713DSK, set the dual inline pin (DIP) switches as shown in the following table. If you have installed the board with different settings, reconfigure the board. Refer to your *TMS320C6201/6713Evaluation Module User's Guide* for details.

DIP Switch	Name	Setting	Outcome
SW2-1	BOOTMODE4	On	Boot mode setting
SW2-2	BOOTMODE3	On	Boot mode setting
SW2-3	BOOTMODE2	Off	Sets memory map = 1 when SW2-5 is off
SW2-4	BOOTMODE1	On	Boot mode setting
SW2-5	BOOTMODE0	Off	Sets memory map =1 when SW2-3 is off
SW2-6	CLKMODE	On	Sets multiply-by-4 mode
SW2-7	CLKSEL	On	Selects oscillator A
SW2-8	ENDIAN	On	Selects little endian mode
SW2-9	JTAGSEL	Off	Selects internal Test Bus Controller (TBC)

DIP Switch	Name	Setting	Outcome
SW2-10	USER2	On	User-defined option
SW2-11	USER1	On	User-defined option
SW2-12	USER0	On	User-defined option

Confirming Your C6713DSK Installation

Texas Instruments supplies a test utility to verify the operation of the board and its associated software. For complete information about running the test utility and interpreting the results, refer to your *TMS320C6201/6713 DSP Starter Kit User's Guide*.

To run the C6713 DSK verification test, complete the following steps after you install your board:

- 1 Start CCS IDE.
- 2 Select **Start > Programs > Code Composer Studio > DSK Confidence Test**. As the test runs, the results appear on your display.

By default, the test utility does not create a log file to store the test results. To specify the name and location of a log file to contain the results of the confidence test, use the command line options in CCS IDE to run the confidence test utility. For further information about running the verification test from a DOS window and using the command line options, refer to *TMS320C6201/6713 Evaluation Module User's Guide*.

- 3 Review the test results to verify that everything works. Check that the options settings match the settings listed in the table above.

If your options settings do not match the configuration shown in the preceding table, reconfigure your C6713 DSK. After you change your board configuration, rerun the verification utility to check your new settings.

Simulink Models and Targeting

Creating Your Simulink Model for Targeting

You create real-time digital signal processing models the same way you create other Simulink models—by combining standard DSP blocks and C-MEX S-functions.

You add blocks to your model in several ways:

- Use blocks from the DSP System Toolbox software
- Use blocks from the fixed-point blocks library TI C62x DSPLIB or TI C64x DSPLIB
- Use other Simulink discrete-time blocks
- Use the blocks provided in the C6000 blockset: ADC, DAC, LED and Reset blocks for specific supported target hardware
- Use blocks that provide the functions you need
- Create and use custom blocks

Once you have designed and built your model, you generate C code and build the real-time executable by clicking **Build** on the Code Generation pane of the Configuration Parameters dialog. The automatic build process creates the file `modelName.out` containing a real-time model image in COFF file format that can run on your target hardware.

The file `modelName.out` is an executable whose format is target-specific. You can load the file to your target and execute it in real time. Refer to your Simulink Coder documentation for more information about the build process.

Targeting – A More Complex Application

- “Overview” on page 45-39
- “Working and Build folders” on page 45-40
- “Setting Simulation Program Parameters” on page 45-40
- “Selecting the Target Configuration” on page 45-41

- “Building and Running the Program” on page 45-42
- “Contents of the Build folder” on page 45-43

Overview

For this tutorial, we show an application that uses multiple stages—using wavelets to remove noise from a noisy signal. Open the example model, `c6713dskwdnoisf`. You can run this denoising example by typing `c6713dskwdnoisf` at the MATLAB prompt. The model also appears in the MATLAB examples collection in the Help browser—under Simulink examples, in the Embedded Coder category. Here is a picture of the model as it appears in the example library.

Wavelet Denoising

C6713 DSK

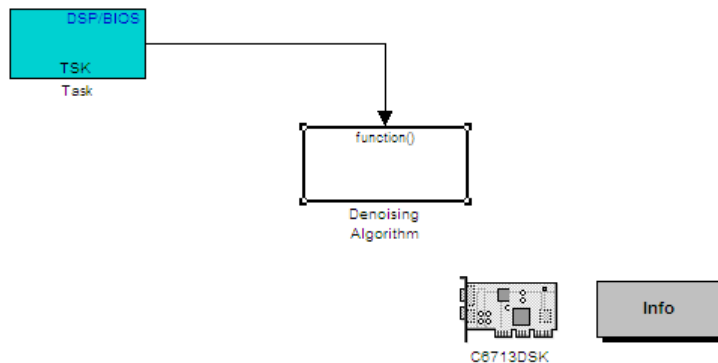

Unlike the audio reverberation example, this model is difficult to build from blocks in Simulink software. It uses complex subsystems for the Delay Alignment block and the Soft Threshold block. For this tutorial, you work with a copy of the example model, rather than creating the model.

This tutorial takes you through generating C code and building an executable program from the example model. The resulting program runs on your C6713 DSK as an executable COFF file.

Working and Build folders

It is convenient to work with a local copy of the `c6713dskwdnoisf` model, stored in its own folder, which you named (something like `c6713dnoisfex`). This discussion assumes that the `c6713dnoisfex` folder resides on drive `d:`. Use the right drive letter for your machine. Set up your working folder as follows:

- 1 Create the new model folder from the MATLAB Command Window by typing

```
!mkdir d:\c6713dnoisfex (on PC)
```

- 2 Make `c6713dnoisfex` your working folder.

```
cd d:/c6713dnoisfex
```

- 3 Open the `c6713dskwdnoisf` model.

```
c6713dskwdnoisf
```

The model appears in the Simulink window.

- 4 From the **File** menu, choose **Save As**. Save a copy of the `c6713dskwdnoisf` model as `d:/c6713dnoisfex/dnoisfrtw`.

During code generation, Simulink Coder software creates a build folder within your working folder. The build folder name is `model_target_rtw`, derived from the name of your source model and your chosen target hardware. In the build folder, Simulink Coder software stores generated source code and other files created during the build process. You examine the contents of the build folder at the end of this tutorial.

Setting Simulation Program Parameters

To generate code appropriately from the `dnoisfrtw` model, you must change some of the Configuration Parameters. In particular, Simulink Coder software uses a fixed-step solver. To set the parameters, use the Configuration Parameters dialog as follows:

- 1 Select **Simulation > Model Configuration Parameters**. The Configuration Parameters dialog opens.

- 2 Click **Solver** and enter the following parameter values on the **Solver** pane. Note that Embedded Coder software does not honor a stop time if you set one here.

Start Time: 0.0

Stop Time: inf

Solver options: set **Type** to Fixed-step. Select the Discrete solver algorithm. (Targeting does not work with continuous time solvers.)

Fixed step size: auto

Tasking mode for periodic sample times: Auto

- 3 Click **Apply**, and then click **OK** to close the dialog.
- 4 Save the model. Configuration Parameters persist with the model (as the model configuration set), for you to use in future sessions.

Selecting the Target Configuration

To specify the desired target configuration, choose the **System target file**.

In these tutorials, you do not need to specify these parameters individually. Instead, you use the ready-to-run `idmlink_grt.tlc` target configuration.

Note In the Configuration Parameters dialog, you can expand the node for the **Code Generation** pane in order to see other important panes. During this tutorial you change or review options in just a few of those panes.

To target your C6713 DSK:

- 1 Select **Simulation > Model Configuration Parameters**. The Configuration Parameters dialog opens.
- 2 Select the **Code Generation** pane.
- 3 Click **Browse** next to the **System target file** field. This opens the **System Target File Browser**. The browser displays a list of available target

configurations. When you select a target configuration, Simulink Coder software automatically chooses the right system target file.

- 4 From the list of available configurations, select `idelink_grt.tlc`, and click **OK**.
- 5 Expand the node for the Code Generation pane and select **Coder Target**.
- 6 Set the **Run-Time** and **Vendor Tool Chain** as shown in the preceding figure.
- 7 To export the handle (a variable) that CCS IDE creates when you generate code from your model, select **Export IDE link handle to base workspace**, and enter a name for the handle in **IDE link handle name**.
- 8 Click **OK** to close the Configuration Parameters dialog. Save the model to retain your new build settings.

Building and Running the Program

The Simulink Coder build process generates C code from your model, and then compiles and links the generated program.

To build and run your program:

- 1 Access the Configuration Parameters dialog for your model.
- 2 Click **Build** in the **Code Generation** pane to start the build process.
- 3 A number of messages concerning code generation and compilation appear in the MATLAB workspace. The initial messages are

```
### Starting Simulink Coder build procedure for model:  
dnoisfrtw  
### Generating code into build folder: .\dnoisfrtw_c6000_rtw
```

The content of the succeeding messages depends on your compiler and operating system. The final message is

```
### Successful completion of Simulink Coder build procedure  
for model: dnoisfrtw
```

- 4** The working folder now contains an executable, `dnoisfrtw.exe`. In addition, Simulink Coder software created a build folder, `dnoisfrtw_c6000_rtw`.

To review the contents of the working folder after the build, type the `dir` command at the MATLAB command prompt.

```
dir
.          dnoisfrtw.exe      dnoisfrtw_c6000_rtw
..         dnoisfrtw.slx
```

- 5** To run the executable from the MATLAB command prompt, type

```
!dnoisfrtw
```

The “!” character passes the command that follows it to the operating system, which runs the stand-alone `dnoisfrtw` program.

The program produces one line of output.

```
**starting the model**
```

- 6** To see the contents of the build folder, type

```
dir dnoisfrtw_c6713_rtw
```

Contents of the Build folder

The build process creates a build folder and names it `model_target_rtw`, concatenating the name of your source model and your chosen target hardware. In this example, your build folder is named `dnoisfrtw_c6713_rtw`.

`dnoisfrtw_c6713_rtw` contains these generated source code files:

- `dnoisfrtw.c` — The stand-alone C code that implements the model.
- `dnoisfrtw.h` — An include header file containing information about the state variables
- `dnoisfrtw_export.h` — An include header file containing information about exported signals and parameters

The build folder also contains other files used in the build process, such as the object (.obj) files and the generated makefile (dnoisfrtw.mk).

Targeting Your C6713 DSK and Other Hardware

- “Overview” on page 45-44
- “Confirming Your C6713 DSK Installation” on page 45-44
- “Running Models on Your C6713 DSK” on page 45-45

Overview

Embedded Coder software lets you use Simulink Coder software to generate, target, and execute Simulink models on the Texas Instruments (TI) C6713 DSP Starter Kit (C6713 DSK). In combination with the C6713 DSK, your the Embedded Coder is the ideal resource for rapidly prototyping and developing embedded systems applications for the TI C6713 Digital Signal Processor. The Embedded Coder focuses on developing real-time digital signal processing (DSP) applications for the C6713 DSK.

This chapter describes how to use the Embedded Coder to create and execute applications on the C6713 DSK. To use the targeting software, you should be familiar with using Simulink to create models and with the basic concepts of Simulink Coder software automatic code generation. To read more about Simulink Coder software, refer to your Simulink Coder documentation.

Confirming Your C6713 DSK Installation

Texas Instruments supplies a test utility to verify operation of the board and its associated software. For complete information about running the test utility and interpreting the results, refer to your “TMS320CDSK Help” under TMS320C6000 Code Composer Studio Help in the CCS online help system.

To run the C6713 DSK confidence test, complete the following steps after you install and configure your board.

- 1** Open a DOS command window.
- 2** Access the folder `..\ti\c6000\dsk6x11\confstest`

CCS IDE creates this folder when you install it. It contains the files to run the C6713 confidence test.

- 3 Start the confidence test by typing `dsk6xtst` at the DOS prompt.

By default, the test utility creates a log file named `dsk6xtst.log` where it stores the test results. To specify the name and location of a log file to contain the results of the confidence test, use the CCS IDE command line options to run the confidence utility. For further information about running the confidence test from a DOS window and using the command line options, refer to the "DSK Confidence Test" topic in the CCS IDE online help.

- 4 Review the test results to verify that everything works.

If your confidence test fails, reconfigure your C6713 DSK. After you change your board configuration, rerun the confidence utility to check your new settings.

Running Models on Your C6713 DSK

Texas Instruments markets a complete set of tools for use with the C6713 DSK. These tools are primarily intended for rapid prototyping of control systems and hardware-in-the-loop applications.

This section provides a brief example of how the TI development tools work with Simulink Coder software, the Embedded Coder, and the C6713 DSK block library.

Executing code generated from Simulink Coder software on a particular target in real-time requires target-specific code. Target-specific code includes I/O device drivers and an interrupt service routine.

Other components, such as Embedded Coder software, are required if you need the ability to download parameters on-the-fly to your target hardware.

Since these components are specific to particular hardware targets (in this case, the C6713 DSK), check that the target-specific components are compatible with the target hardware.

To allow you to build an executable, the Embedded Coder provides a target makefile specific to C6000 hardware targets. This target makefile invokes the optimizing compiler provided as part of CCS IDE.

Used in combination with the Embedded Coder and Simulink Coder software, TI products provide an integrated development environment that, once installed, does not need additional coding.

After you have installed the C6713 DSK development board and supporting TI products on your PC, start the MATLAB software. At the MATLAB command prompt, type `c6713dsklib`. This opens a Simulink block library, `c6713dsklib`, that includes a set of blocks for C6713 DSK I/O devices:

- C6713 DSK ADC — Configure the analog to digital converter
- C6713 DSK DAC — Configure the digital to analog converter
- C6713 DSK LED — Control the user-defined light emitting diodes (LED) on the C6713 DSK
- C6713 DSK DIP Switch — Set the dual inline pin switches on the C6713 DSK
- C6713 DSK Reset — Reset the processor on the C6713 DSK

These devices are associated with your C6713 DSK board.

With your model open, select **Simulation > Model Configuration Parameters** from the menu bar to open the Configuration Parameters dialog.

In the Configuration Parameters dialog, select the **Code Generation** pane. For the C6713 DSK set **System target file** to `idelink_grt.tlc`

With this configuration, you can generate and download a real-time executable to your TI C6713 DSK. Start the Simulink Coder build process by clicking **Build** on the Code Generation pane. Simulink Coder software automatically generates C code and inserts the I/O device drivers as specified by the ADC and DAC blocks in your block model.

These device drivers are inserted in the generated C code as inlined S-functions. Inlined S-functions offer speed advantages and simplify the generated code. For more information about inlining S-functions, refer to

your Target Language Compiler documentation. For a complete discussion of S-functions, refer to your documentation about writing S-functions.

During the same build operation, the software invokes the TI compiler to build an executable file.

If you select the `Build_and_execute` option, the executable file is automatically downloaded via the peripheral component interface (PCI) bus to the TI evaluation board. After downloading the executable file to the C6713 DSK, the build process runs the file on the digital signal processor.

Starting and Stopping DSP Applications on the C6713 DSK. When you create, build, and download a Simulink model to the C6713 DSK, you are not running a simulation of your DSP application. You are running the actual machine code corresponding to the block diagram you built in Simulink software. To start running your DSP application on the evaluation module, you must open your Simulink model and rebuild the machine executable by clicking **Build** on the Code Generation pane. Each time you want to start the application on the C6713 DSK, you use Simulink Coder software to rebuild the executable from the Simulink model and download the code to the board.

Your model runs until the model encounters one of the following actions:

- Using the **Debug > Halt** option in CCS IDE
- Using halt from the MATLAB command prompt
- Encountering a Stop block in the model.
- Clicking the C6713 DSK Reset block in your model (if you added one) or in the DSK block library

Clicking the Reset block stops the running application and restores the digital signal processor to its initial state.

Creating Code Composer Studio Projects Without Building

- “Introduction” on page 45-48

- “Creating Projects in CCSv3 IDE Without Loading Files to Your Target” on page 45-48

Introduction

Rather than targeting your C6000 board when you build your signal processing application, you can create Texas Instruments Code Composer Studio (CCSv3) IDE projects. Creating projects for CCSv3 IDE lets you use the tools provided by the CCSv3 software suite to debug your real-time process.

If you build and download your Simulink model to CCSv3 IDE, Embedded Coder software opens Code Composer Studio software, creates a new CCSv3 IDE project named for your model, and populates the new project with the files it creates during the build process—the object code files, the assembly language files, the map files, and other required files. As a result, you can immediately use CCSv3 IDE to debug your model using the features provided by the CCSv3 IDE.

Creating a project in CCSv3 IDE is the same as targeting C6000 hardware. You configure your target options, select your build action to create a CCSv3 IDE project, and then build the project in CCSv3 IDE by clicking **Make Project**.

Creating Projects in CCSv3 IDE Without Loading Files to Your Target

In the Configuration Parameters dialog, expand the node for the **Code Generation** pane, and then select the **Coder Target** pane. Set **Build action** to `Create_project`. The `Archive_library` option does not create a CCSv3 IDE project. The other options are not relevant when you are simply creating an IDE project.

Return to the Simulink Coder category, clear **Generate code only** and click **Build** to build your new CCSv3 IDE project.

Simulink Coder software and Embedded Coder software generate the files for your project in CCSv3 IDE and create a new project in the IDE. Your new project is named for the model you built, with a custom project build configuration `CustomMW`, not `Release` or `Debug`.

In CCSv3 IDE you see your project with the files in place in the folder tree.

Targeting Custom Hardware

- “Overview” on page 45-49
- “Typical Targeting Process” on page 45-50
- “Targeting a Custom Target” on page 45-52
- “Section Pane” on page 45-57
- “To Create Memory Maps for Targets” on page 45-61

Overview

As long as the processor on your custom board is from the TI C6000 DSP family, you can use Embedded Coder software to generate code for your target hardware.

The blocks for the peripherals in the C6000 DSP Library, such as the C6416 DSK ADC or C6713 DSK DAC blocks, are specific to their hardware and will not work with your custom board. The board-specific blocks provided by this toolbox do not work with custom hardware.

The Target Hardware Resources pane provides a way to target boards that are not specifically supported. Within the support for Texas Instruments products, custom hardware targeting only works with the C6000 DSPs. This is due to certain features related to memory maps and other processor-specific attributes.

Several guidelines apply to your targeting configuration decisions when you decide to use custom targets and the custom Target Hardware Resources pane:

- 1 Specify the memory allocation (memory mapping) using the **Memory** and **Section** panes on the Target Hardware Resources pane in the Configuration Parameters dialog. Set the memory mapping for your target that best matches your hardware. For example, if your custom target uses the C6713 processor, be sure your memory configuration is the same as the one on the supported C6713 DSK, such as has the same memory size,

the same EMF settings, the same memory sections, and the same cache organization.

- 2** To use on-chip memory only for your target, choose the `Near_Calls` setting for the **Memory model** in the **TI C6000 compiler** options. To use external memory that is specific to your board, choose the `Far_Calls` setting for the **Memory model**. The other selection in the **Memory model** list offers a combination of near and far allocation for data and aggregate data.
- 3** Do not use the existing ADC, DAC, DIP Switch, or LED blocks unless you are quite sure that your hardware is identical to the matching EVM or DSK in important respects. Generally, the ADC, DAC, and other target-specific blocks are design specifically for their designated targets and can cause problems when you use them on hardware that is not identical.
- 4** Set the **Overrun notification method** in the **TI C6000 runtime** category to `Print_message` when you use the overrun notification feature. If you choose to use the LED notification option, verify that on your specialized target you access the LEDs in exactly the same way, and the LEDs respond in the same way, as the LEDs on the corresponding supported DSK or EVM.

To use one of the custom targets, create your model, open the model Configuration Parameters dialog, and configure the Coder Target pane for your custom target.

Typical Targeting Process

Generally, targeting hardware, or a development environment as it is called by some, requires that you complete a series of processes that starts with building your model and ends with generating code to suit your target hardware.

- 1** Build the Simulink model of your algorithm or process to be converted to code for your target hardware.
- 2** Add target-specific blocks to your model, such as ADC and DAC blocks, and configure the block parameters. (Skip this step when you are targeting a processor on a custom board.)
- 3** Configure your model as described in “Configure Target Hardware Resources” on page 35-3.

Configure the options on the Target Hardware Resources pane to select the target, map memory segments, allocate code and data sections to the memory segments, and set other target-specific options.

4 Build your model to your target hardware.

Memory Maps. Memory maps are an essential part of targeting processors or boards. Without the map, the code generation process cannot determine where various features of the generated code, such as variables, data, and executable code, reside on the target hardware.

To discuss memory maps and configuring memory, a few terms need to be defined:

- Memory map — Map of the memory space for a target system. The memory space is partitioned into functional blocks.
- memory segment — Memory partition that corresponds to a physical range of memory on the target hardware. The segment is named in some fashion, such as IPRAM or SDRAM.
- Memory section — The smallest unit of an object file. This is a block of data or code that, based on the memory map, resides in an area of contiguous memory on the target and in the memory map. Sections of object files are both distinct and separate. Memory sections come in two flavors:
 - Uninitialized sections that reserve memory space for uninitialized data. One example of an uninitialized section is `.bss`. The `.bss` section reserves space for variables that are not initialized.
 - Initialized sections contain code and data. The `.text` (containing executable code) and `.data` (containing initialized data) sections are initialized.
- Memory management — Process of specifying the memory segments that the various memory sections use for your application. A logical memory map of the hardware memory results from the process of managing memory.

During code generation, the linker and assembler work to allocate your code and data into the memory on your target according to the memory map specifications you provide. For more information about memory utilization and memory management, refer to the CCS IDE online help, using keywords like memory map, memory segment, and section.

The compiler does not interact with the memory map. It does not have information about memory allocation or the memory map. As far as the C6000 compiler is concerned, the physical memory on your target is one continuous linear block of memory that is subdivided into smaller blocks containing code, data, or both.

When you configure the Target Hardware Resources pane, you are setting up the memory map for your target hardware. You specify the memory segments that are defined and the contents of each segment. You specify the sections, both named and default, and the segments to which the sections are assigned.

These memory management functions are identical to the ones available in the CCS IDE Configuration Tool.

Targeting a Custom Target

To use a board that has a TI C6000 processor but is not one of the supported boards, configure the Target Hardware Resources pane as described in this section.

Configuring the block parameters software about your target hardware and how to generate code that will run on the target hardware.

- 1** Configure your model as described in “Configure Target Hardware Resources” on page 35-3, setting the **Board** parameter to **C6000 Custom**.
- 2** Select your target hardware from the **Processor** list. Most of the C6000 family of DSP processors are on the list. If the one you need is not listed, pick one that closely matches your target hardware.
- 3** Set the actual CPU clock rate for the CPU on your target in the **CPU Clock** parameter. Report the clock speed of the processor on your target hardware. When you enter a value, you are not changing the CPU clock rate, you are reporting the actual rate. If the value you enter does not match the rate on the target, your model real-time results and code profiling results might be wrong. You must enter the actual clock rate the board uses. The rate you enter here does not change the rate on the board. Setting the **CPU clock** parameter to the actual board rate allows the code you generate to run well according to the actual clock rate of the hardware.

- 4 If your target is a simulator rather than a hardware target, use the **Get from IDE** button on the **Board** pane of the Target Hardware Resources pane. Then set **Board Name** under **IDE Support** to one of the simulators installed with your IDE.
- 5 To enable the Embedded Coder to connect to CCS IDE, select your target from the **Board Name** list. On this list you see the names of the boards you have configured in the CCS Setup Utility. If your target board does not appear on the list, start CCS Setup and add your board to the System Configuration dialog.
- 6 Select the processor to target from the **Processor Name** list. For the board you selected in **Board Name**, **Processor Name** lists the processors on the board. The list comes from the processors you added to the board in the CCS Setup Utility.

Now you have completed the process of identifying your target to the Embedded Coder and Simulink Coder software. While this process is required, it represents only one small part of enabling you to generate code to run on your custom board.

One very important part of targeting custom hardware is to provide the target memory map configuration to the linker and assembler.

Memory and **Section** panes on the Target Hardware Resources pane in the Configuration Parameters dialog provide the controls required to specify how the linker and assembler arrange the code, data, and variables on your target hardware.

Memory Pane. The information that follows describes the options on the panes in detail.

The **Memory** pane contains memory options in three areas:

- **Physical Memory** specifies the mapping for processor memory
- **Heap** specifies whether you use a heap and determines the size in words
- **L2 Cache** enables the L2 cache (where available) and sets the size in kB

Be aware that these options can change the options on the **Section** pane. You can make selections here that change how you configure options on the **Section** pane.

Most of the information about memory segments and memory allocation is available from the Code Composer Studio online help.

Physical Memory Options. This list shows the physical memory segments available on the board and processor. By default, Target Hardware Resources pane shows the memory segments found on the selected processor. In addition, the **Memory** pane shows the memory segments available on the board, but off of the processor. Target Hardware Resources pane has default starting addresses, lengths, and contents of the default memory segments.

The default memory segments for each processor and board are different. For example:

- Custom boards based on C670x processors provide IPRAM and IDRAM memory segments by default.
- C6713 DSK boards provide SDRAM memory segment by default

Name. When you highlight an entry on the **Physical memory** list, the name of the entry appears here. To change the name of the existing memory segment, select it in the Physical memory list and then type the new name here.

Note You cannot change the names of default processor memory segments.

To add a new physical memory segment to the list, click **Add**, replace the temporary label in **Name** with the one to use, and press **Return**. Your new segment appears on the list.

After you add the segment, you can configure the starting address, length, and contents for the new segment. New segments start with code and data as the type of content that can be stored in the segment (refer to the **Contents** option).

Names are case sensitive. `NewSegment` is not the same as `newsegment` or `newSegment`.

Address. **Address** reports the starting address for the memory segment showing in **Name**. Address entries are in hexadecimal format and limited only by the board or processor memory.

When you are using a processor-specific preferences block, the starting address shown is the default value. You can change the starting value by entering the new value directly in **Address** when you select the memory segment to change.

Length. From the starting address, **Length** sets the length of the memory allocated to the segment in **Name**. As in the memory entries, specify the length in hexadecimal format, in minimum addressable data units (MADUs). For the C6000 processor family, the MADU is 8 bytes, one word.

When you are using a processor-specific preferences block, the length shown is the default value. You can change the value by entering the new value directly in this option.

Contents. **Contents** describes the kind of program sections that you can store in the memory segment in **Name**. As the processor type for the Target Hardware Resources pane changes, the kinds of information you store in listed memory segments can change. Generally, the **Contents** list contains these strings:

- **Code** — Allow code to be stored in the memory segment in **Name**.
- **Data** — Allow data to be stored in the memory segment in **Name**.
- **Code and Data** — Allow code and data to be stored in the memory segment in **Name**. When you add a new memory segment, this is the default setting for the contents of the new element.

You can add or use as many segments of each type as you need, within the limits of the memory on your processor.

Add. Click **Add** to add a new memory segment to the target memory map. When you click **Add**, a new segment name appears, for example NEWMEM1, in **Name** and on the **Physical memory** list. In **Name**, change the temporary name NEWMEM1 by entering the new segment name. Entering the new name, or clicking **Apply** updates the temporary name on the list to the name you enter.

Remove. This option lets you remove a memory segment from the memory map. Select the segment to remove in the **Physical memory** list and click **Remove** to delete the segment.

Create Heap. If your processor supports using a heap, as does the C6713, for example, selecting this option enables creating the heap and enables the **Heap size** option. **Create heap** is not available on processors that either do not provide a heap or do not allow you to configure the heap.

Using this option you can create a heap in a memory segment on the **Physical memory** list. Select the memory segment on the list and then select **Create heap** to create a heap in the select segment. After you create the heap, use the **Heap size** and **Define label** options to configure the heap.

The location of the heap in the memory segment is not under your control. The only way to control the location of the heap in a segment is to make the segment and the heap the same size. Otherwise, the compiler determines the location of the heap in the segment.

Heap Size. After you select **Create heap**, this option lets you specify the size of the heap in words. Enter the number of words in decimal format. When you enter the heap size in decimal words, the system converts the decimal value to hexadecimal format. You can enter the value directly in hexadecimal format as well. Processors may support different maximum heap sizes.

Define Label. Selecting **Create heap** enables this option that allows you to name the heap. Enter your label for the heap in the **Heap label** option.

Heap Label. Selecting **Define label** enables this option. You use **Heap Label** to provide the label for the heap. Don't use reserved characters in C/C++ compilers.

Enable L2 Cache. C621x, C671x, and C641x processors support an L2 cache memory structure that you can configure as SRAM and partial cache. Both the data memory and the program share this second-level memory. C620x DSPs do not support L2 cache memory, and this option is not available when you choose one of the C620x processors as your target hardware.

If your processor supports the two-level memory scheme, this option enables the L2 cache on the processor.

L2 Cache Size. After you enable the L2 cache, select the size of the cache from the list.

Section Pane

Options on this pane let you specify where various program sections should go in memory. Program sections are distinct from memory segments—sections are portions of the executable code stored in contiguous memory locations. Among the sections used generally are `.text`, `.bss`, `.data`, and `.stack`. Some sections relate to the compiler, some to DSP/BIOS, and some can be custom sections as you require.

For more information about program sections and objects, refer to the CCS IDE online help. Most of the definitions and descriptions in this section come from CCS IDE.

In the pane shown in the preceding figure, you configure the allocation of sections for **Compiler**, **DSP/BIOS**, and **Custom** needs.

This table provides brief definitions of the various kinds of sections in the **Compiler**, **DSP/BIOS**, and **Custom** lists. Some sections do not appear on both lists. The string appears on the list shown in the table.

String	Section List	Description of the Section Contents
<code>.args</code>	DSP/BIOS	Argument buffers
<code>.bss</code>	Compiler	Static and global C variables in the code

String	Section List	Description of the Section Contents
.bios	DSP/BIOS	DSP/BIOS code if you are using DSP/BIOS options in your program
.cinit	Compiler	Tables for initializing global and static variables and constants
.cio	Compiler	Standard I/O buffer for C programs
.const	Compiler	Data defined with the C qualifier and string constants
.data	Compiler	Program data for execution
.far	Compiler	Variables, both static and global, defined as far variables
.gblinit	DSP/BIOS	Load allocation of the DSP/BIOS startup initialization tables section
.hwi	DSP/BIOS	Dispatch code for interrupt service routines
.hwi_vec	DSP/BIOS	Interrupt Service Table
.obj	DSP/BIOS	Configuration properties that the target program can read
.pinit	Compiler	Load allocation of the table of global object constructors section.
.stack	Compiler	The global stack
.switch	Compiler	Jump tables for switch statements in the executable code
.sysdata	DSP/BIOS	Data about DSP/BIOS
.sysinit	DSP/BIOS	DSP/BIOS initialization startup code
.system	Compiler	Dynamically allocated object in the code containing the heap

String	Section List	Description of the Section Contents
.text	Compiler	Load allocation for the literal strings, executable code, and compiler generated constants
.trcdata	DSP/BIOS	TRC mask variable and its initial value section load allocation

You can learn more about memory sections and objects in your Code Composer Studio online help.

Compiler Sections. During program compilation, the C6000 compiler produces both uninitialized and initialized blocks of data and code. These blocks are allocated into memory as required by the configuration of your system. On the **Compiler Sections** list you find both initialized (sections that contain data or executable code) and uninitialized (sections that reserve space in memory) sections. The initialized sections are

- .cinit
- .const
- .switch
- .text (created by the assembler)

These sections are uninitialized:

- .bss (created by the assembler)
- .far
- .stack
- .systemem

Other sections appear on the list as well:

- .data (created by the assembler)
- .cio

- .pinit

Note The C/C++ compiler does not use this section.

When you highlight a section on the list, **Description** shows a brief description of the section. Also, **Placement** shows you where the section is currently allocated in memory.

Description. Provides a brief explanation of the contents of the selected entry in the **Compiler Sections** list.

Placement. Shows you where the selected **Compiler Sections** list entry is allocated in memory. You change the memory allocation by selecting a different location from the **Placement** list. The list contains the memory segments as defined in the physical memory map on the **Memory** pane. Select one of the listed memory segments to allocate the highlighted compiler section to the segment.

DSP/BIOS Sections. During program compilation, DSP/BIOS produces both uninitialized and initialized blocks of data and code. These blocks get allocated into memory as required by the configuration of your system. On the **DSP/BIOS sections** list you find both initialized (sections that contain data or executable code) and uninitialized (sections that reserve space in memory) sections.

Description. Provides a brief explanation of the contents of the selected **DSP/BIOS Sections** list entry.

Placement. Shows where the selected **DSP/BIOS Sections** list entry is allocated in memory. You change the memory allocation by selecting a different location from the **Placement** list. The list contains the memory segments available on C6000 processors, and changes based on the processor you are using.

DSP/BIOS Object Placement. Distinct from the entries on the **DSP/BIOS Sections** list, DSP/BIOS objects like LOG, if your project uses them, are placed in the memory segment you select from the **DSP/BIOS Object Placement** list. The DSP/BIOS objects use the same memory segment. You cannot select the locations for individual objects.

Custom Sections. When your program uses code or data sections that are not included in either the **Compiler Sections** or **DSP/BIOS Sections** lists, you add the new sections to this list. Initially, the **Custom Sections** list does not contain fixed entries, just a placeholder for a section for you to define.

Name. You enter the name for your new section here. To add a new section, click **Add**. Then replace the temporary name with the name to use. Although the temporary name includes a period at the beginning, you do not need to include the period in your new name. Names are case sensitive. `NewSection` is not the same as `newsection`, or `newSection`.

Placement. With your new section added to the **Name** list, select the memory segment to which to add your new section. Within the restrictions imposed by the hardware and compiler, you can select a segment that appears on the list.

Add. Clicking **Add** lets you configure a new entry to the list of custom sections. When you click **Add**, the block provides a new temporary name in **Name**. Enter the new section name to add the section to the **Custom Sections** list. After typing the new name, click **Apply** to add the new section to the list. Or click **OK** to add the section to the list and close the dialog.

Remove. To remove a section from the **Custom Sections** list, select the section to remove and click **Remove**. The selected section disappears from the list.

To Create Memory Maps for Targets

Although each processor has memory map requirements, the C6000 DSP family of processors share some memory features and not others. Details of the memory sections and segments, as well as memory allocations and limitations for each processor, are provided in your documentation for CCS IDE and from TI.

To manage the memory on your processor, set the options within these panes to specify the memory allocation to use. Recall that the memory map is the result of the settings you provide for the options in the **Memory** and **Section** panes in the Target Hardware Resources pane in the Configuration Parameters dialog.

Unfortunately, each processor has different needs, and the differences make it impossible to provide details about how you set the options for your target hardware. You determine, from your model and code

- What memory segments you require
- Which sections you need and where
- Whether you need custom memory segments and sections
- Where to begin each memory segment and how much memory to allot to each segment
- Other information that you need to set the options on the **Memory** and **Section** panes

After you configure the options in the Target Hardware Resources pane in the Configuration Parameters dialog, you are ready to set the Simulink Configuration Parameters for your model and generate code.

Using Embedded Coder Software

- “Introduction” on page 45-62
- “To Use the Embedded Coder Target File” on page 45-63

Introduction

To take advantage of Embedded Coder software features, you must migrate your models to a system target file called `idmlink_ert.tlc`. This target is based on the embedded real-time target (ERT) used by Embedded Coder software. Other Embedded Coder target files are based on the generic real-time target (GRT).

To use Embedded Coder software, choose the system target file `idmlink_ert.tlc`, available in the **System Target File Browser**.

If you simply choose the system target file `idelink_ert.tlc` in the **System Target File Browser** directly to change the target for the model, the **Coder Target** options are reset to default values by the switch. The C6000-specific options are the same between the two system target files.

You can set your model to use this system target file the usual way, via the **System Target File Browser**, available from the **Simulink Coder** pane in the Configuration Parameters dialog. However, when you use the system target browser to switch your model between the ERT- and GRT-based TI C6000 system target files, the TI C6000-specific options (the configuration set) for the model are reset to default values.

To Use the Embedded Coder Target File

For setting up a new model to use the ERT-based target `.tlc` file.

- 1** From your model menu bar, select **Simulation > Model Configuration Parameters**.
- 2** In the Configuration Parameters dialog, select the **Code Generation** pane.
- 3** Click **Browse** to open the **System Target File Browser**.
- 4** On the **System Target File Browser**, find and select the file `idelink_ert.tlc`.
- 5** Click **OK**.

Targeting with DSP/BIOS Options

In this section...
“Introducing DSP/BIOS” on page 45-64
“DSP/BIOS and Targeting Your C6000 DSP” on page 45-65
“Code Generation with DSP/BIOS” on page 45-68
“Profiling Generated Code” on page 45-72
“Generating Code for C64x+ Processors or Boards” on page 45-85

Introducing DSP/BIOS

Embedded Coder software supports DSP/BIOS features as options when you generate code for your target hardware. In the following sections, read more about DSP/BIOS, how the Embedded Coder incorporates DSP/BIOS features into your generated code, and ways to use the real-time operating system (RTOS) features of DSP/BIOS in your applications. Follow these links for more information on specific areas that interest you, or read on for more details.

- “DSP/BIOS and Targeting Your C6000 DSP” on page 45-65
- “Code Generation with DSP/BIOS” on page 45-68
- “Profiling Generated Code” on page 45-72
- “Generating Code for C64x+ Processors or Boards” on page 45-85

As a part of the Texas Instruments eXpressDSP™ technology, TI designed DSP/BIOS to include three components:

- DSP/BIOS Real-Time Analysis Tools — use these tools within Code Composer Studio IDE to view your program as it executes on the target in real time.
- DSP/BIOS Configuration Tool — enables you to add and configure DSP/BIOS objects that you use to instrument your application. Use this tool to configure interrupt schedules and handlers, set thread priorities, and configure the memory layout on your DSP.

- DSP/BIOS Application Program Interface (API) — use C or assembly language functions to access DSP/BIOS functions by calling over 150 API functions. Embedded Coder software uses the API to access DSP/BIOS.

You link these components into your application, directly or indirectly referencing only functions you need for your application to run efficiently and optimally. Only functions that you specifically reference become part of your code base. To avoid adding unused code to your project, the software excludes functions you do not reference. After you add DSP/BIOS functions, the configuration tool helps you disable features you do not need later, optimizing your program for speed and size.

For details about DSP/BIOS and what it can do for your applications, refer to your CCS IDE and DSP/BIOS documentation from Texas Instruments.

DSP/BIOS and Targeting Your C6000 DSP

- “Introduction” on page 45-65
- “DSP/BIOS Configuration File” on page 45-66
- “Memory Mapping” on page 45-67
- “Hardware Interrupt Vector Table” on page 45-67
- “Linker Command File” on page 45-67

Introduction

When you generate code from your DSP model, you can include DSP/BIOS features provided by Embedded Coder software.

Including DSP/BIOS in your generated project adds the following files to your project:

- `modelName.tcf` — a DSP/BIOS configuration file
- `modelnamecfg.s62` — contains the DSP/BIOS objects required by your application and the vector table for the hardware interrupts.
- `modelnamecfg.h62` — the header file for `modelnamecfg.s62`.
- `modelnamecfg.h` — model configuration header file.

- `modelnamecfg_c.c` — source code for the model.
- `modelnamecfg.cmd` — the linker command file for the project. Adds the required DSP/BIOS libraries and the library `RTS6201.lib`, or the run-time support library for your target hardware.

The executable code and source code you generate when you use the DSP/BIOS option are not the same as the code generated without DSP/BIOS included.

Instead of incorporating the DSP/BIOS files manually, as you would with CCS IDE, the Embedded Coder software starts from your Simulink model and adds the DSP/BIOS files automatically. As it adds the files, the support package:

- Configures the DSP/BIOS configuration file for your model needs
- Sets up the objects you use to analyze your program while it runs on your target
- Handles memory mapping to optimize your code based on the blocks in your model

DSP/BIOS Configuration File

DSP/BIOS projects have a file with the extension `.tcf`. The file contains the DSP/BIOS configuration information for your project, in the form of objects for instrumenting and scheduling tasks in the program code. A DSP/BIOS project can include the following files:

- Log (LOG) objects for logging events and messages (replace the `*printf` statements, for instance)
- A clock (CLK) object for configuring the clock on your target, and various memory functions
- Hardware and software interrupt (HWI, SWI) objects that control program execution
- Other objects you use to meet your needs

Your TI DSP/BIOS documentation can provide the details about the objects and how to use them. In addition, your installed software from TI includes tutorials to introduce you to using DSP/BIOS in projects.

Not all of the DSP/BIOS objects get used by the code you generate from Embedded Coder software. In the next sections, you learn about which objects the targeting software uses and how. You can still add more objects to your code through CCS IDE.

If you add DSP/BIOS objects beyond those provided by the Embedded Coder, you lose your additions when you regenerate code from your Simulink model.

Memory Mapping

Memory mapping that takes place in the linker command file now appears in the MEM object in the DSP/BIOS configuration file. Your memory sections, such as the DATA_MEM assignments and definitions, move to the MEM object, as do the memory segments. After completing this conversion, the memory assignment portions of your non-DSP/BIOS linker command file are not required in the linker command file.

Hardware Interrupt Vector Table

In non-DSP/BIOS project, the assembly language file `vector.asm` in your project defines the hardware interrupt vector table. This file defines which interrupts your project uses and what each one does.

When you use DSP/BIOS, the interrupts defined in the vector table move to the Hardware Interrupt Service Routine Manager in the CCS Configuration Tool. With your interrupts defined as Hardware Interrupts (HWI) in the Configuration Tool, your project does not need `vector.asm`, so the file does not appear in your DSP/BIOS enabled projects.

Linker Command File

After migrating your memory sections, segment, and hardware interrupt vector table to the configuration file, building with the DSP/BIOS option creates a compound linker command file. Because DSP/BIOS allows only one command file per project, and your linker file may comprise command options that did not relocate the DSP/BIOS configuration, Embedded Coder software uses *compound* command files. Compound command files work to let your project use more than one command file.

By starting your original linker command file with the statement

```
"-lmodelnamecfg.cmd"
```

added as the first line in the file, your DSP/BIOS enabled project uses both your original linker command file and the DSP/BIOS command file. You get the features provide by DSP/BIOS as well as the custom command directives you need.

Code Generation with DSP/BIOS

- “Overview” on page 45-68
- “Enabling DSP/BIOS When You Generate Code” on page 45-68
- “Generated Code Without and With DSP/BIOS” on page 45-69

Overview

While generating code that includes the DSP/BIOS options is straightforward, changes occur between code that does not include DSP/BIOS and code that does. Two things change when you generate code with DSP/BIOS—files are added and removed from the project in CCS IDE, and DSP/BIOS objects become part of your generated code. With these in place, you can use the DSP/BIOS features in CCS IDE to debug your project, as well as use the profiling option in Embedded Coder software to check the performance of your application running on your target hardware.

Enabling DSP/BIOS When You Generate Code

To include DSP/BIOS when you generate code from a model:

- 1** Open the model.
- 2** Configure your model as described in “Configure Target Hardware Resources” on page 35-3.
- 3** On the Target Hardware Resources pane, select the **Board** pane, and set the **Operating system** parameter to DSP/BIOS.

Generated Code Without and With DSP/BIOS

The next two figures show the results of generating code without and with the DSP/BIOS option enabled in the **Simulation Parameters** dialog.

CCS 3.3 IDE c6713dskwdnoisf.pjt Project Without DSP/BIOS. When you create your project in CCS IDE, the folder structure looks like this.

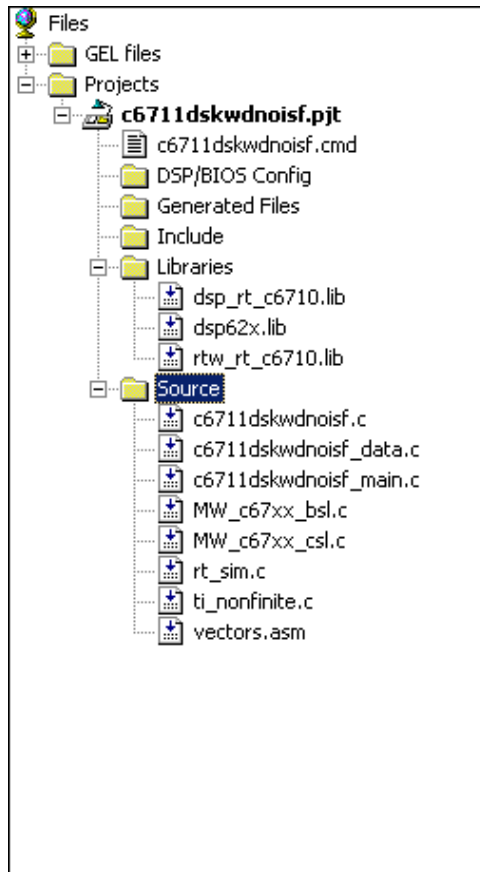

CCS 3.3 IDE c6713dskwdnoisf.pjt Project with DSP/BIOS. If you now create a project that includes DSP/BIOS, the folder structure for your project changes to look like the following figure.

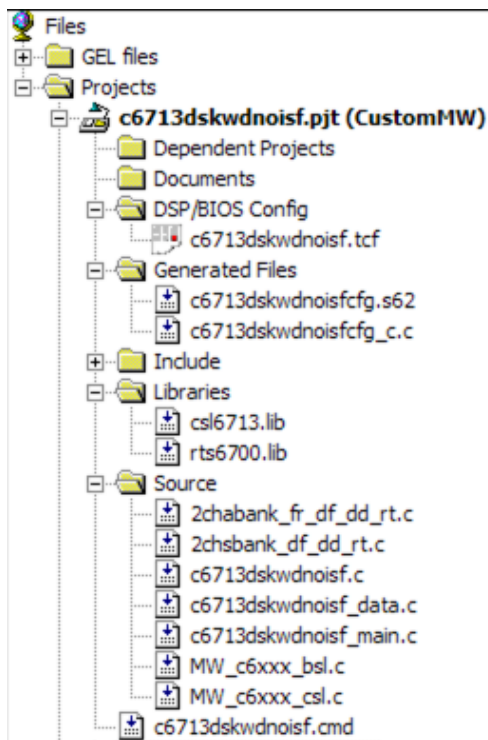

Added File	Description
modelName.tcf	Contains the DSP/BIOS objects required by your application, and the vector table for the hardware interrupts
modelnamecfg.s62	Shows the included files in your project, the variables, the DSP/BIOS objects, and more in this file generated from the .tcf file
modelnamecfg.h62	The header file for modelnamecfg.s62
modelnamecfg.h	Model configuration header file

Added File	Description
modelNamecfg_c.c	Source code for the model
modelNamecfg.cmd	The linker command file for the project. Adds the required DSP/BIOS libraries and the library <code>RTS6201.lib</code> or the run-time support library for your target hardware.

Notice that the new folder includes some new files, shown in the next table.

With DSP/BIOS functions enabled for your project, the following files do not appear in your project.

Filename	Description
vectors.asm	Defines the hardware interrupts (HWI) used by interrupt service routines on the processor. This file is removed after the hardware interrupts appear in the HWI section of the Configuration Tool.
Original linker command file—modelName.cmd	Assigns memory sections on the processor. This file is removed if the SECTION directive is empty because the section assignments moved to the configuration file. Otherwise, include call to the DSP/BIOS command file.
Some *.lib files	Provide access to libraries for the processor, and peripherals. These files are removed if their contents have been incorporated in the new compound linker command file.

When you investigate your generated code, notice that the function main portion of `modelName_main.c` includes different code when you generate DSP/BIOS-enabled source code, and `modelName_main.c` incorporates one or more new functions.

Profiling Generated Code

- “Overview” on page 45-72
- “Profiling Subsystems” on page 45-73
- “Details About Timing and Profiling” on page 45-74
- “Profiling Multitasking Systems” on page 45-75
- “The Profiling Report” on page 45-76
- “Interrupts and Profiling” on page 45-78
- “Reading Your Profile Report” on page 45-79
- “Definitions of Report Entries” on page 45-80
- “Profiling Your Generated Code” on page 45-82
- “To Enable Profiling for Your Generated Code” on page 45-82
- “To Create Atomic Subsystems for Profiling” on page 45-83

Overview

When you use Embedded Coder software to generate code that incorporates the DSP/BIOS options, you can easily profile your generated code to gauge performance and find bottlenecks.

By selecting **Profile real-time execution** in the Embedded Coder software options, Embedded Coder software inserts the profiling instrumentation at the beginning and end of the code for each atomic subsystem in your model.

After your code has been running for a few seconds on your target, you can retrieve the profiling results from your target and display the information in a custom HTML report.

Code profiling works only on atomic subsystems in your model. To allow the Embedded Coder to profile your model when you build it in Simulink Coder software, you convert segments of your model into atomic subsystems using **Diagram > Subsystem & Model Reference > Create Subsystem from Selection**.

By designating subsystems of your model as atomic, you force each subsystem to execute only when all of its inputs are available. Waiting for the subsystem inputs to be available before running the subsystem allows the subsystem code to be profiled as a contiguous segment.

To enable the profile feature for your Simulink model, select **Simulation > Model Configuration Parameters** from the model menu bar. Under **Code Generation**, select the **Coder Target** pane and enable the **Profile real-time execution** parameter.

Profiling Subsystems

Nested subsystems are profiled as part of their parent systems—the execution time reported for the parent subsystem includes the time spent in profiled child subsystems. You cannot profile child subsystems separately.

For models that include multiple sample times, one or more subsystems in your model might not be included in the profiling process. When your model is configured to use single-tasking mode, the atomic subsystems in your model are profiled and appear in the report. When your model uses multitasking (refer to your Simulink Coder documentation for more about multitasking models) profiling applies only to single-rate subsystems that execute at the base rate of your model. This limitation arises because all of the generated code segments must execute contiguously for the profiling timing measurements to be accurate. Setting the **Tasking mode for periodic sample times** to Auto in the model Configuration Parameters does not necessarily result in contiguous execution for the code segments and subsystems.

Notice two things in your code:

- STS objects are added to the generated code
- A generated DSP/BIOS configuration gets added to the project configuration file

Embedded Coder software inserts and configures these objects specifically for profiling your code. You do not have to make changes to the STS objects. To see the statistics objects in use, download your generated application to your board, select **DSP/BIOS > Statistics View** from the menu bar in CCS IDE,

and run the board for a few seconds. You see the statistics being accumulated by the STS objects.

Details About Timing and Profiling

The profiling system in Embedded Coder software relies on DSP/BIOS STS objects and the `CLK_getthtime()` function. `CLK_getthtime()` returns a high resolution timing counter that enables profiling to measure the instruction cycles the CPU spends executing code segments. To understand profiling, you need to understand how `CLK_getthtime()` works.

This is how the system determines the value of `CLK_getthtime()`:

```
CLK_getthtime() return val = CLK_getltime() *PRD0 + CNT0
```

`PRD0` and `CNT0` are timer 0 period and counter registers. In code generation, BIOS allocates timer 0 as a system timer and set the timer to generate a timer interrupt every 1ms. `CLK_getltime()` in turn returns the number of BIOS system timer interrupts. By this logic, `PRD0` is set to the number of CPU clock cycles divided by the number of low resolution clock cycles that is equivalent to 1 millisecond in absolute time (8 low resolution clock cycles for C64x processors, for example).

The key point here is that function `CLK_getthtime()` relies on the `CLK_getltime()` function which in turn relies on a timer 0 interrupt. If your process globally disables interrupts during code execution for more than 1 `PRD0` instruction cycle, one or more timer interrupts can be missed, resulting in a situation where both `CLK_getltime()` and `CLK_getthtime()` can be inaccurate.

`CLK_getltime()` will be inaccurate because it does not report the time value properly. But it is positive. The situation is worse for `CLK_getthtime()` It may report negative timing around code segments where interrupts are disabled:

```
A = CLK_getthtime();
IRQ_globalDisable();
{
    Code segment;
}
IRQ_globalEnable();
B = CLK_getthtime();
```

In this situation, if interrupts are disabled longer than 1ms around the code segment to be profiled, B might be smaller than A since CTN0 might have rolled over. So the count of the instruction cycles computed as (B - A) might be negative.

Correcting Inaccurate Profile Information Due to Timing. One way to solve problems in profiling caused by the disabled interrupts is to set the DSP/BIOS system timer interrupt to occur less frequently. As noted earlier, the timer is set to 1 millisecond by default.

You can change setting manually after you generate code for your project. Here are the steps to use to reset the DSP/BIOS system timer interval.

- 1 Open the .tcf file for the project.
- 2 Select **Scheduling > CLK Clock Manager**.
- 3 Right-click CLK Clock Manager to set the properties for the clock manager.
- 4 Change the **Microseconds/Int** value from the default 1000.00 microseconds to something larger, for example, 5000.00 microseconds.
- 5 Save the project.

This timing change reduces the chances of missing a system timer interrupt. If you do this and profile the code again, the profiling results improve.. You can verify that if you reduce the system timer interrupt interval further, to perhaps 100 microseconds, the profiling results degrade, possibly reporting negative timing values.

Profiling Multitasking Systems

For a multitasking system, DSP/BIOS STS objects cannot reliably measure the time the processor spends in the tasks. When tasks can be preempted by other tasks (a result of multitasking operation), the profile timing measurements may be inaccurate. For this reason, Embedded Coder software includes profiling instrumentation for atomic systems that run at the base sample rate only.

When you run the same model in single tasking mode, you can get the timing measurements for the systems in your model for one iteration:

- 1** Select **Simulation > Model Configuration Parameters** from the model menu bar.
- 2** On the **Solver** pane, set **Tasking mode for periodic sample times** to `SingleTasking`.
- 3** Rebuild and execute your model on your C6000 hardware.

The program will probably overrun immediately since single tasking mode requires that the tasks complete within the base sample time which usually does not happen. However, the systems and subsystems do run once before the program terminates. This allows you to obtain profiling results for the systems.

When the overrun occurs, click **Halt** in CCS IDE to stop DSP/BIOS operation.

Then, enter `CCS_Obj.profile('report')` at the MATLAB prompt to report the statistics measurements.

Now you can view the timing measurements for each subsystem. Keep in mind that the percentages are given relative to the base sample time, so you must do some arithmetic to figure out whether a given system will fit in its available time interval. For instance, if your base sample time is 1 second, subsystem A executes every 3 seconds, the base-rate task takes 0.1 seconds to run, and A takes 2.5 seconds to run, the system should execute without overruns in multitasking mode.

If you change the overrun action option from its default setting of `Notify and halt` to `Notify and continue` or `None`, you can get measurements for multiple iterations of the system. Also, you will be able to request the profile report without first halting the CPU.

The Profiling Report

To help you measure subsystem performance, Embedded Coder software provides a custom report that analyzes and displays the profile statistics. The report shows you the amount of time spent computing each subsystem, including `Outputs` and `Update` code segments, and provides links that open the corresponding subsystem in the Simulink model.

To view the profiling report, enter

```
profile(IDE_Obj, 'report')
```

at the MATLAB prompt, where `IDE_Obj` is the handle to your target and CCS IDE, and `report` is one of the input arguments for `profile`.

When you generate the report, the Embedded Coder stores the report in your code generation working folder, something like `modelName.c6000.rtw`, with the name `profileReport.html`.

If the MATLAB® software cannot find your code generation folder, the profile reports is stored in your temporary folder, `tempdir`. To locate your temporary folder, enter

```
tempdir
```

at the MATLAB command prompt.

Caution Each time you run the profiling process, the software replaces your existing report with a newer version. To save earlier reports, rename and save the report before you generate a new one, or change your destination temporary folder in the MATLAB workspace.

You must invoke `profile` after your Simulink Coder build, without clearing MATLAB memory between operations, so that stored information about the model is still available to the report generator. If you clear your MATLAB memory, information required for the profile report gets deleted and the report does not work well. When this occurs, and if you have a CCS IDE project that was previously created with Simulink Coder software, you must repeat the Simulink Coder build to see the subsystem-based profile analysis in the report.

Trace each subsystem presented in the profile report back to its corresponding subsystem in your Simulink model by clicking a link in the report. (The mapping from Simulink subsystems to generated system code is complex and thus not detailed here.) Inspect your generated code, particularly `modelName.c`, to determine where and how Simulink and Simulink Coder software implemented particular subsystems.

Within the generated code, you see entries like the following that define STS objects used for profiling.

```
STS_set(&stsSys0_Output, CLK_gettime());
```

or

```
STS_delta(&stsSys0_Output, CLK_gettime());
```

This pair of code examples perform the profiling of the code section that lies between them in `modelName.c`.

In CCS IDE, STS objects show up in the Statistics Object Manager section under **Instrumentation** in the `modelName.tcf` file. Double-click the file `modelName.tcf` in the CCS IDE tree view to open the file and see the sections.

In some cases, Simulink Coder software may have pruned unused data paths, causing related performance measurements to become meaningless. Reusable system code, or code reuse, where a single function is called from multiple places in the generated code, can exhibit extra measurements in the profile statistics, while the duplicate subsystem may not show valid measurements.

Interrupts and Profiling

Although there are STS objects that measure the execution time of the entire `mdlOutputs` and `mdlUpdate` functions, those measurements can be misleading because they do not include other segments of code that execute at each interrupt. Statistics for the SWI are used when calculating the headroom (the difference between the number of CPU cycles your process requires to complete and the number available for the process to complete, which does not include the small overhead required for each interrupt. Note that profiling of multitasking systems does not measure the headroom. In addition, multitasking profiling does not use the SWI statistics.

To measure the overall application CPU usage, consider the DSP/BIOS IDL statistics, which measure time spent *not* doing application work. Your DSP/BIOS documentation from TI provides details about the various DSP/BIOS objects in the `tcf` file.

The interrupt rate for a DSP/BIOS application created by Embedded Coder software is the fastest block execution rate in the model. The interrupt rate

is often the same as the codec frame rate. When there is an upsampling operation or other rate increasing operation in your model, interrupts are triggered by a timer (PRD) object at the faster rate. You can determine the effective interrupt rate of the model by inverting the interrupt interval reported by the profiler.

Profiling subsystems that contain “blocking” device drivers, such as the ADC/DAC blocks and C6000 UDP Receive blocks may produce inaccurate and misleading results, raising values for **Max time spent in this subsystem per interrupt** and **Max percent of base interval** by many orders of magnitude. To avoid this problem, design subsystems to isolate blocking device drivers from algorithmic and other processing functions, and configure profiling appropriately.

Reading Your Profile Report

After you have the report from your generated code, you need to interpret the results. This section provides a link to sample report from a model and explains each entry in the report.

Sample of a Profile Report. When you click Sample Profile Report, the sample report opens in a new Help browser window. This opens the sample report in a new window so you can read the report and the descriptions of the report contents at the same time. Running the model `c6713dskwdnoisf` with DSP/BIOS generates the sample profile report. The next sections explain the headings in the report—what they mean and how they are measured (where that applies).

Report Heading Information. At the beginning of the report, profiling provides the name of the model you profiled, the target you used, and the date of the report. Since the report changes each time you run it, the date can be an important means of tracking model development.

Report Subsections and Contents. Within the body of your profile report, sections report the overall performance of your generated code and the performance of each atomic subsystem.

Report Heading	Description
Timing Constants	Shows you the base sample time in your model (=1/base rate in Hz) and the CPU clock speed used for the analysis.
Profiled Simulink Subsystems	Presents the statistics for each profiled subsystem separately, by subsystem. Each listing includes the STS object name or names that instrument the subsystem.
STS Objects	Lists every STS object in the generated code and the statistics for each. DSP/BIOS uses these objects to determine the CPU load statistics. For more information about STS objects, refer to your DSP/BIOS documentation from TI.

STS objects that are associated with subsystem profiling are configured for host operation at $4 \times x$, reflecting the numerical relationship between CPU clock cycles and high-resolution timer clicks, x . STS Average, Max, and Total measurements return their results in counts of instructions or CPU clock cycles.

Definitions of Report Entries

In the following sections, we provide definitions of the entries in the profile report. These definitions help you decipher the report and better understand how your process is performing.

System name. Provides the name of the profiled model, using the form *targetnameprofile*. *targetname* is the processor or board assigned as the target, via the Target Hardware Resources pane.

Number of Iterations Counted. The number of interrupts that occurred between the start of model execution and the moment the statistics were obtained.

CPU Clock Speed. The instruction cycle speed of your digital signal processor. On the C6713 DSK, you can adjust this speed to one of four values, where 100 MHz is the default—25, 33.25, 100, 133 MHz. If you change the speed to something other than the default setting of 100 MHz, you must specify the new speed in the Simulink Coder software options. Use the **Current C6713DSK CPU clock rate** option on the TIC6000 runtime category on the Simulink Coder tab.

Set at a fixed 150 MHz, you cannot change the CPU clock rate on the C6713 DSK. You do not need to report the setting in the Simulink Coder software options.

Maximum Time Spent in This Subsystem per Interrupt. The amount of time spent in the code segment corresponding to the indicated subsystem in the worst case. Over the iterations measured, the maximum time that occurs is reported here. Since the profiler only supports single-tasking solver mode, a calculation can not be preempted by a new interrupt. Calculations for the subsystems must complete within one interrupt cycle, even for subsystems that execute less often than the fastest rate.

Maximum Percent of Base Interval. The worst-case execution time of the indicated subsystem, reported as a percentage of the time between interrupts.

STS Objects. Profiling uses STS objects to measure the execution time of each atomic subsystem. STS objects are a feature of the DSP/BIOS run-time analysis tools, and one STS object can be used to profile exactly one segment of code. Depending on how Simulink Coder software generates code for each subsystem, there may be one or two segments of code for the subsystem; the computation of outputs and the updating of states can be combined or separate. Each subsystem is assigned a unique index, *i*. The name of each STS object helps you determine the correspondence between subsystems and STS objects. Each STS object has a name of the form

`stsSysi_segment`

where *i* is the subsystem index and `segment` is `Output`, `Update`, or `OutputUpdate`. For example, in the sample profile report shown in the next section, the STS objects have the names `stsSys1_OutputUpdate`, and `stsSys2_OutputUpdate`.

Profiling Your Generated Code

Before profiling your generated code, you must configure your model and Simulink Coder software to support the profiling features in Embedded Coder software. Your model must use DSP/BIOS features for profiling to work fully.

The following tasks compose the process of profiling the code you generate.

- 1 Enable DSP/BIOS for your code.
- 2 Enable profiling in the Simulink Coder software.
- 3 Create atomic subsystems to profile in your model.
- 4 Build, download, and run your model.
- 5 Use `profile` to view the MATLAB profile report.

To show profiling of generated code, this procedure uses the wavelet denoising model `c6713dskwdnoisf` that is included with Embedded Coder example programs. If you are using the C6713 DSK as your target, use the model `C6713dskwdnoisf` throughout this procedure. Simulators work as well, just choose the right model for your simulator.

Begin by loading the model, entering

```
c6713dskwdnoisf
```

at the MATLAB prompt. The model opens on your desktop.

To Enable Profiling for Your Generated Code

Recall that you must use DSP/BIOS in your code to use profiling.

To enable the profile feature for your Simulink model, select **Simulation > Model Configuration Parameters** from the model menu bar. Under **Code Generation**, select the **Coder Target** pane and enable the **Profile real-time execution** parameter.

To Create Atomic Subsystems for Profiling

Profiling your generated code depends on two features—DSP/BIOS being enabled and your model having one or more subsystems defined as atomic subsystems. To learn more about subsystems and atomic subsystems, refer to your Simulink documentation in the Help browser.

In this tutorial, you create two atomic subsystems—one from the Analysis Filter Bank block and a second from the Soft Threshold block:

- 1 Select the Analysis Filter Bank block. Select **Diagram > Subsystem & Model Reference > Create Subsystem from Selection** from the model menu bar. The name of the block changes to subsystem. Repeat for the Soft Threshold block.
- 2 To convert your new subsystems to atomic subsystems, right-click each subsystem and choose **Subsystem parameters...** from the context menu.
- 3 In the **Block Parameters: Subsystem** dialog for each subsystem, select the **Treat as atomic unit** option. Click **OK** to close the dialog. If you look closely you can see that the subsystems now have heavier borders to distinguish them from the other blocks in your model.

To Build and Profile Your Generated Code. You have enabled profiling in your model and configured two atomic subsystems in the model as well. Now, use the profiling feature to see how your code runs and check the performance for bottlenecks and slowdowns as the code runs on your target hardware.

Caution Do not click other open models while you are profiling your model. Clicking on another open model can cause profiling to fail with an error message like “Invalid Simulink object specifier.”

- 1 Click **Build Model**  on the model toolbar.

If you did not use the Simulink Coder software options to automate model compiling, linking, downloading, and executing, perform these tasks using the **Project** options in CCSv3 IDE.

Allow the application to run for a few seconds or as long as required to execute the model segments of interest a few times. Then stop the program.

2 Create a link to CCSv3 IDE by entering

```
IDE_Obj = ticcs;
```

at the MATLAB prompt.

3 Enter

```
profile(IDE_Obj, 'report')
```

at the prompt to generate the profile report of your code executing on your target hardware.

The profile report appears in the Help browser. It should look very much like the following sample report; your results may differ based on your target and the settings in the model.

Profile Report

Simulink model: [c6416dskprofile.mdl](#)
Target: C6416DSK

Report of profile data from Code Composer Studio (tm)
XX-XXX-2005 17:27:27

Timing constants

Base sample time	250 ms
CPU Clock speed ¹	720 MHz

Profiled Simulink Subsystems

System name	c6416dskprofile
STS object	stsSys2_OutputUpdate
Max time spent in this subsystem per interrupt	14.93 μ s
Max percent of base interval	0.00597%
Number of iterations counted	144

System name	c6416dskprofile/Subsystem1
STS object	stsSys1_OutputUpdate
Max time spent in this subsystem per interrupt	12.8 μ s
Max percent of base interval	0.00512%
Number of iterations counted	144

Generating Code for C64x+ Processors or Boards

The Target Hardware Resources pane imports hardware information directly from DSP/BIOS.

To configure a Target Hardware Resources pane for your C64x+ processor or board:

- 1 Set the DSP/BIOS installation folder location using the MATLAB Command Window.

For CCSv3, enter the `setDspbiosFolder` command. For example:

```
>> setDspbiosFolder('(path to DSP/BIOS)\bios_5_33_06');
```

For CCSv4/5, also specify the XDC installation folder. For example:

```
>> setDspbiosFolder('(path to TI tools)\bios_5_41_02_14',  
'(path to TI tools)\xdctools_3_10_05_61')
```

2 Import the processor / board information from DSP/BIOS:

```
>> importDspbiosConfig('board', 'all')
```

```
>> importDspbiosConfig('proc', 'all')
```

3 Configure your model as described in “Configure Target Hardware Resources” on page 35-3.

4 On the Target Hardware Resources pane, set **Board** to C64x+, and set **Processor** to match the processor on your target hardware.

The Embedded Coder software uses the BIOS_INSTALL_DIR environment variable to locate the DSP/BIOS installation folder. Then, it queries DSP/BIOS for a list of processors and boards with C64x+ cores and displays them in the **Processor** list. When you select a processor and click **Yes**, the software imports settings from DSP/BIOS such as the memory map, cache settings, and CPU clock rate and applies them settings to the **Memory, Section** and **DSP/BIOS** tabs.

If you change DSP/BIOS versions in the CCS Component Manager while the Target Hardware Resources pane is open, close and reopen the Target Hardware Resources pane to update the **Processor** options.

5 On the Target Hardware Resources pane, verify the **CPU Clock** rate for your processor.

6 To improve the efficiency of your application, you can adjust the L1 and L2 cache values and other parameters in the Memory, Section, and DSP/BIOS tabs. The following section provides an example of how to adjust these settings.

7 Click **OK**.

Later, you can reopen the library by entering the name of the library in the MATLAB Command Window.

Configuring Target Hardware Resources for OMAP-L138/C6748 EVM

To create a custom Target Hardware Resources pane for OMAP-L138/C6748 EVM:

- 1** Configure your model as described in “Configure Target Hardware Resources” on page 35-3.
- 2** In the Target Hardware Resources pane, set **IDE/Tool Chain** to match your version of Code Composer Studio
- 3** Set **Board** to OMAP-L138/C6748 EVM.

Because this board has only one type of processor, this action automatically sets the **Processor** parameter to OMAPL138 and updates the **Memory, Section** and **DSP/BIOS** tabs with default values for that processor.

- 4** Review the cache settings:
 - a** Click the **Memory** tab.
 - b** Verify that **L1D** and **L1P** cache are set to 32 kb.
 - c** If you adjust the cache size, also adjust the **L1PSRAM** and **L1DSRAM** values to accommodate memory taken from the high address range of the corresponding L1 memory segments. Because L1PSRAM and L1DSRAM are 32 kb in the OMAP-L138/C6748 processor, the **Length** for **L1PSRAM** and **L1DSRAM** is 0x00000000. These settings use the entire L1 memory as level one cache.
 - d** Verify that **L2** cache is set to 128 kb, and that the **Length** for **IRAM** is 0x00020000 (128 kb).
 - e** On the Target Hardware Resources pane **Memory** tab, confirm the following settings and click **Apply**.

Name	Address	Length	Contents
L1PSRAM	0x11e00000	0x00000000	Code
L1DSRAM	0x11f00000	0x00000000	Data
IRAM	0x11800000	0x00020000	Code & Data

Name	Address	Length	Contents
L3_CBA_RAM	0x80000000	0x00020000	Code & Data
DDR	0xc3000000	0x01000000	Code & Data

- 5** On the **Section** tab, observe that the **Compiler sections** have been assigned to optimize the efficiency of the generated code. The `.stack`, `.bios`, `.hwi`, and `.hwi_vec` sections are placed in fast internal memory (IRAM). The other sections are assigned to external memory (DDR). This approach avoids linking errors caused by placing excessive code and data in limited internal memory. It also runs critical sections of the application from internal memory.
- 6** The final step in configuring the OMAP-L138/C6748 EVM Target Hardware Resources pane is to create a heap in external memory. Device drivers from TI use heap to allocate data structures and device driver buffers. Without a heap, integrating device drivers from TI would not be possible.
 - a** Click the **DSP/BIOS** tab.
 - b** In the **Heap** table, verify that the **DDR** check box is selected and that its size is `0x00100000` (1 MB).
 - c** Confirm the following settings for the **DSP/BIOS** tab, and click **OK**.

Parameter	Value
DDR (check box selected)	0x00100000
Data objects	IRAM
Code objects	IRAM
Default stack size (bytes)	4096
Stack segment for static tasks	IRAM
Stack segment for dynamic tasks	DDR

Using the C62x and C64x DSP Libraries

In this section...

“About the C62x and C64x DSP Libraries” on page 45-89

“Fixed-Point Numbers” on page 45-91

“Building Models” on page 45-96

About the C62x and C64x DSP Libraries

- “C62x DSP Library” on page 45-89
- “C64x DSP Library” on page 45-90
- “Supported Platforms” on page 45-90
- “Characteristics Common to C62x and C64x Library Blocks” on page 45-91

C62x DSP Library

Blocks in the C62x DSP library correspond to functions in the Texas Instruments TMS320C62x DSP Library assembly-code library, which target the TI C62x family of digital signal processors. Use these blocks to run simulations by building models in Simulink software before generating code. Once you develop your model, you can invoke Simulink Coder software to generate code that is optimized to run on C6713 DSK development platforms or C62x hardware. (Fixed-point processing on C67x hardware is identical to C62x fixed point hardware and processing so you can develop on the C67x for the C62x.) During code generation, each C62x DSP Library block in your model is mapped to its corresponding TMS320C62x DSP Library assembly-code routine to create target-optimized code.

C62x DSP Library blocks generally input and output fixed-point data types. The block reference topics discuss the data types accepted and produced by each block. “Fixed-Point Numbers” on page 45-91 gives a brief overview of using fixed-point data types in Simulink software.

You can use C62x DSP Library blocks with certain blocks from the DSP System Toolbox software and Simulink software. To learn more about

creating models that include both C62x DSP Library blocks and blocks from other blocksets, refer to “Building Models” on page 45-96.

C64x DSP Library

Blocks in the C64x DSP library correspond to functions in the Texas Instruments TMS320C64x DSP library assembly-code library, which target the TI C64x family of digital signal processors. Use these blocks to run simulations by building models in Simulink software before generating code. Once you develop your model, you can invoke Simulink Coder software to generate code that is optimized to run on the C6416 DSK development platform or other C64x hardware. During code generation, each C64x DSP Library block in your model is mapped to its corresponding TMS320C64x DSP Library assembly-code routine to create target-optimized code.

C64x DSP Library blocks generally input and output fixed-point data types. The block reference topics discuss the data types accepted and produced by each block in the library. “Fixed-Point Numbers” on page 45-91 gives a brief overview of using fixed-point data types in Simulink software. For an in-depth discussion of fixed-point data types, including issues with scaling and precision when you perform fixed-point operations, refer to your Fixed-Point Designer documentation.

You can use C64x DSP Library blocks with certain blocks from the DSP System Toolbox software and Simulink software. To learn more about creating models that include both C64x DSP Library blocks and blocks from other blocksets, refer to “Building Models” on page 45-96.

Note While you can use C62x blocks on C64x targets, the generated code is not optimal for the C64x target. Using the right C64x block creates better optimized code. (Embedded Coder software generates a warning message when you try to do this but allows you to use the block.)

Supported Platforms

The C62x and C64x DSP libraries can be used with the platforms listed in the following table:

Library	Supported platforms
C62x	C62x, C67x, C67x+, C64x, C64x+
C64x	C64x, C64x+

Characteristics Common to C62x and C64x Library Blocks

The following characteristics are common to the C62x and C64x DSP Library blocks:

- The blocks inherit sample times from driving blocks.
- The blocks are single rate.
- Block filter weights and coefficients are tunable, but not in real time. Other block parameters are not tunable.
- The blocks support discrete sample times. Individual block reference pages indicate blocks that also support continuous sample times.

Fixed-Point Numbers

- “Notation” on page 45-91
- “Signed Fixed-Point Numbers” on page 45-92
- “Q Format Notation” on page 45-93

Notation

In digital hardware, numbers are stored in binary words. A binary word is a fixed-length sequence of binary digits (1's and 0's). How hardware components or software functions interpret this sequence of 1's and 0's is defined by the data type.

Binary numbers are represented as either fixed-point or floating-point data types. A fixed-point data type is characterized by the word size in bits, the binary point, and whether it is signed or unsigned. The position of the binary point is the means by which fixed-point values are scaled and interpreted.

For example, a binary representation of a fractional fixed-point number (either signed or unsigned) is shown below.

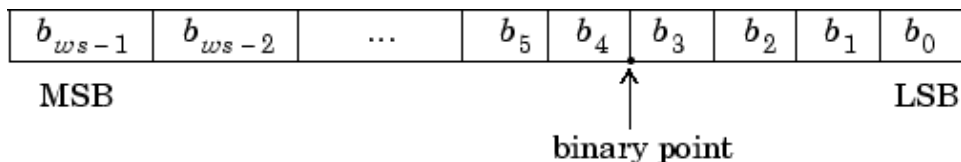

where

- b_i is the i th binary digit.
- ws is the word size in bits.
- b_{ws-1} is the location of the most significant (highest) bit (MSB).
- b_0 is the location of the least significant (lowest) bit (LSB).
- The binary point is shown four places to the left of the LSB. In this example the number is said to have four fractional bits, or a fraction length of four.

Note For Embedded Coder, the results of fixed-point and integer operations in MATLAB/Simulink match the results on the hardware target down to the least significant bit (bit-trueness). The results of floating-point operations in MATLAB/Simulink do not match those on the hardware target, because the libraries used by the third-party compiler may be different from those used by MATLAB/Simulink.

Signed Fixed-Point Numbers

Signed binary fixed-point numbers are typically represented in one of three ways:

- Sign/magnitude
- One's complement
- Two's complement

Two's complement is the most common representation of signed fixed-point numbers and the one TI digital signal processors use.

Negation using signed two's complement representation consists of a bit inversion (translation into one's complement) followed by the binary addition of a one. For example, the two's complement of 000101 is 111011:

000101 → 111010 (bit inversion) → 111011 (binary addition of 1 to the LSB)

results in the negative of 000101 being 111011.

Q Format Notation

The position of the binary point in a fixed-point number determines how you interpret the scaling of the number. When performing arithmetic such as addition or subtraction, hardware uses the same logic circuits regardless of the value of the scale factor. In essence, the logic circuits do not have knowledge of a binary point. They perform signed or unsigned integer arithmetic—as if the binary point is to the right of the LSB (b_0). Therefore, you determine the binary point in your code.

In the C62x DSP Library, the position of the binary point in signed, fixed-point data types is expressed in and designated by Q format notation. This fixed-point notation takes the form

$Q_{m.n}$

where

- Q designates that the number is in Q format notation—the Texas Instruments notation for signed fixed-point numbers.
- m is the number of bits used to designate the two's complement integer portion of the number.
- n is the number of bits used to designate the two's complement fractional portion of the number, or the number of bits to the right of the binary point. Sometimes n is called the scale factor.

Q format designates the most significant bit of a binary number as the sign bit. Representing a signed fixed-point data type in Q format requires $m+n+1$ bits to account for the sign.

Expressing Q Format – Q.15. For example, a signed 16-bit number with $n = 15$ bits to the right of the binary point is expressed as

Q0.15

in this notation. This is (1 sign bit) + (0 = m integer bits) + (15 = n fractional bits) = 16 bits total in the data type. In Q format notation the $m = 0$ is often implied, as in

Q.15

In Fixed-Point Designer software, this data type is expressed as

`sfrac16`

or

`sfix16_En15`

DSP System Toolbox software expresses this data type as the vector

[16 15]

meaning the word length is 16 bits and the fraction length is 15 bits.

Expressing Q Format – Q1.30. Multiplying two Q.15 numbers yields a product that is a signed 32-bit data type with 30 bits to the right of the binary point. One bit is the designated sign bit, forcing m to be 1:

$m+n+1 = 1+30+1 = 32$ bits total

Therefore this number is expressed as

Q1.30

In Fixed-Point Designer software, this data type is expressed as

`sfix32_En30`

In DSP System Toolbox software, this data type is expressed as

[32 30]

Expressing Q Format – Q-2.17. Consider a signed 16-bit number with a scaling of $2^{(-17)}$. This requires $n = 17$ bits to the right of the binary point, meaning the most significant bit is a *sign-extended* bit.

Sign extension adds bits to the high end (MSB end) of the word and fills the added bits with the value of the MSB. For example, consider a 4-bit two's complement number 1011. Extending the number to 7 bits with sign extension changes the number to 1111011—the value of the number remains the same.

One bit is the designated sign bit, forcing m to be -2.

$$m+n+1 = -2+17+1 = 16 \text{ bits total}$$

Therefore this number is expressed as

Q-2.17

In Fixed-Point Designer software, this data type is expressed as

`sfixed16_En17`

To express this data type in DSP System Toolbox software, use

`[16 17]`

Expressing Q Format – Q17.-2. Consider a signed 16-bit number with a scaling of $2^{(2)}$ or 4. The binary point is implied to be 2 bits to the right of the 16 bits, or that there are $n = -2$ bits to the right of the binary point. One bit must be the sign bit, forcing m to be 17.

$$m+n+1 = 17+(-2)+1 = 16$$

Therefore this number is expressed as

Q17.-2

In Fixed-Point Designer software, this data type is expressed as

`sfixed16_E2`

In DSP System Toolbox software, this data type is expressed as

[16 -2]

Building Models

- “Overview” on page 45-96
- “Converting Data Types” on page 45-96
- “Using Sources and Sinks” on page 45-97
- “Choosing Blocks to Optimize Code” on page 45-97

Overview

You can use C62x or C64x DSP Library blocks in models along with certain core Simulink and DSP System Toolbox software. This section discusses issues you should consider when you build models with blocks from these libraries.

Converting Data Types

Blocks you connect in a model have compatible input and output data types. In most cases, C62x or C64x DSP Library blocks handle only a limited number of specific data types. Refer to the block reference page for a discussion of the data types that each block accept and produces.

When you connect C62x or C64x DSP Library blocks and Simulink blocks, you often need to set the data type and scaling in the block parameters of the Simulink block to match the data type of the C62x DSP Library block. Many Simulink blocks allow you to set their data type and scaling by inheriting from the driving block, or by back propagating from the next block. This can be a good way to set the data type of a Simulink block to match a connected C62x DSP Library block.

Some DSP System Toolbox software blocks and Simulink blocks also accept fixed-point data types. Make the right settings in the block parameters when you connect them to a C62x DSP Library block.

To use DSP System Toolbox software or core Simulink blocks that do not handle fixed-point data types with C62x DSP Library blocks in your model, you must use the right data type conversion block:

- To connect fixed-point and nonfixed-point blocks, use the Data Type Conversion block from the Simulink Data Type library.
- To provide an interface to nonfixed-point blocks, use the C62x Convert Floating-Point to Q.15 and C62x Convert Q.15 to Floating-Point blocks from the C62x DSP Library.
- To connect blocks of varying nonfixed-point data types in your model, use the Data Type Conversion block from the Signals and Systems Simulink library
- To connect blocks of varying fixed-point data types in your model, use the Data Type Conversion Inherited block from the Simulink Data Type library.

Refer to the reference pages for these blocks or invoke the Help system from their block dialogs for more information.

Using Sources and Sinks

The C62x DSP Library does not include source or sink blocks. Use source or sink blocks from the core Simulink library or DSP System Toolbox software in your models with C62x DSP Library blocks. See “Converting Data Types” on page 45-96 for more information on incorporating blocks from other libraries into your models.

Choosing Blocks to Optimize Code

In some cases, blocks that perform similar functions appear in more than one blockset. For example, the C62x DSP Library, the C64x DSP Library, and the DSP System Toolbox software have Autocorrelation blocks. How do you choose which to include in your model? If you are building a model to run on the C6713 DSK or on C62x hardware, choosing the block from the C62x DSP Library yields better optimized code. You can use a similar block from another library if it provides functionality that the C62x DSP Library block does not support, but you generate less well optimized code.

In the same manner, if you are building a model to run on the C6416 DSK or on C64x hardware, choosing the block from the C64x DSP Library yields better optimized code. You can use a similar block from another library if it provides functionality that the C64x DSP Library block does not support, but you generate less well optimized code.

Configuring Timing Parameters for CAN Blocks

Setting Timing Parameters

- “Accessing the Timing Parameters” on page 45-98
- “Determining Timing Parameter Values” on page 45-99
- “Working with CAN Bit Timing” on page 45-100

Accessing the Timing Parameters

The timing parameters that control the bit rate for DM643x CAN Receive and DM643x CAN Transmit blocks are **Baud rate prescaler**, **TSEG1**, and **TSEG2** in the DM643x CAN Setup block.

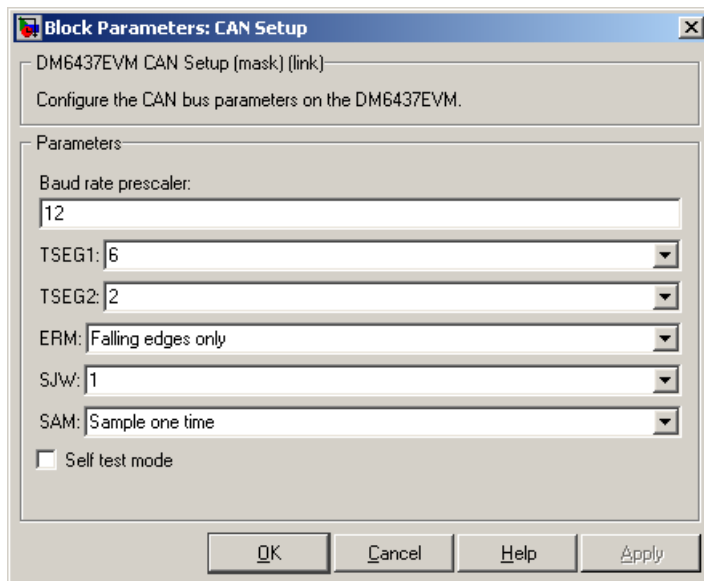

The following sections describe how to set these parameters.

Determining Timing Parameter Values

The following steps show you how to determine the right values to use for the timing parameters.

1 Gather these two values:

- Bit rate of the CAN network
- CAN Module Clock Frequency — The CAN peripheral in the DM6437 is in the CLKIN clock domain, which operates at the same frequency as the primary reference clock to the DSP. In the DM6437EVM board, the primary reference clock operates at 27 MHz.

2 Estimate the value of the **Baud rate prescaler (BRP)** and then solve this equation for BitTime:

$$\text{BitTime} = \text{CAN Module Clock Frequency} / (\text{BRP} * \text{Bit rate})$$

3 Estimate values for **TSEG1** and **TSEG2** that satisfy the following equation:

$$\text{BitTime} = \text{TSEG1} + \text{TSEG2} + 1$$

The estimated values must also satisfy the following constraints:

$$\text{TSEG1} \geq \text{TSEG2}$$

$$\text{IPT (Information Processing Time)} = 3/\text{BRP}$$

$$\text{IPT} \leq \text{TSEG1} \leq 16 \text{ TQ}$$

$$\text{IPT} \leq \text{TSEG2} \leq 8 \text{ TQ}$$

$$1 \text{ TQ} \leq \text{SJW} \leq \min(4 \text{ TQ}, \text{TSEG2})$$

where:

IPT is Information Processing Time, TQ is Time Quanta, and SJW is Synchronization Jump Width, which can be set in the **CAN Setup** block.

4 Iterate steps two and three until the values selected for TSEG1, TSEG2, and BRP meet the criteria.

The following illustration shows the relationship between the parameters:

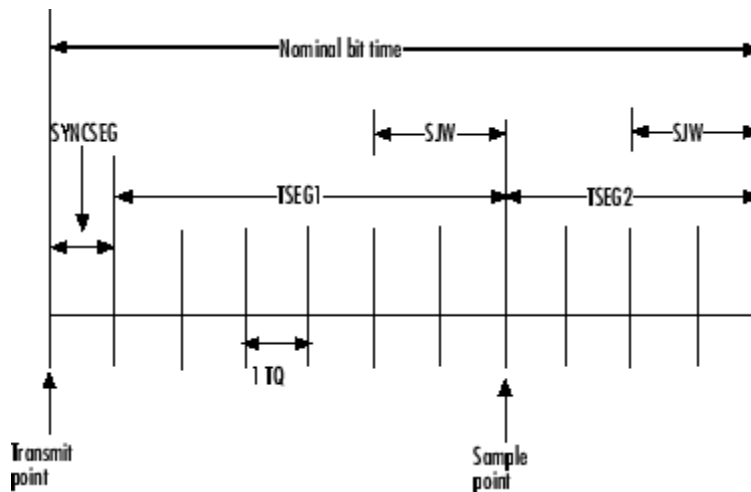

Working with CAN Bit Timing

This example shows how to determine CAN timing parameters.

Assume that CAN Module Clock Frequency = 27 MHz, and a Bit rate of 1 Mbits/s is required.

- 1 With the **Baud rate prescaler (BRP)** set to 12, substitute the values of Bit rate, *BRP*, and *CAN Module Clock Frequency* into the following equation, solving for *BitTime*:

$$\text{BitTime} = \text{CAN Module Clock Frequency} / (\text{BRP} * \text{Bit rate})$$

$$\text{BitTime} = 27\text{MHz} / (12 * 0.25 \text{ Mbits/sec}) = 9\text{TQ}$$

- 2 Set the values of **TSEG1** and **TSEG2** to 6TQ and 2TQ, respectively. Substitute the values of *BitTime* from the previous equation, and the chosen values for *TSEG1* and **TSEG2** into the following equation:

$$\text{BitTime} = \text{TSEG1} + \text{TSEG2} + 1$$

$$9\text{TQ} = 6\text{TQ} + 2\text{TQ} + 1$$

3 Finally, check the selected values against the rules:

$$\text{IPT} = 3/\text{BRP} = 3/12 = .25$$

$$\text{IPT} \leq \text{TSEG1} \leq 16 \text{ TQ True! } .25 \leq 6\text{TQ} \leq 16\text{TQ}$$

$$\text{IPT} \leq \text{TSEG2} \leq 8\text{TQ True! } .25 \leq 2\text{TQ} \leq 8\text{TQ}$$

$$1\text{TQ} \leq \text{SJW} \leq \min(4\text{TQ}, \text{TSEG2}), \text{ as a result of which SJW can be set to either 1 or 2.}$$

4 The chosen values satisfy the criteria, so you have determined the parameter values and can stop.

The following table provides common timing parameter settings for typical values of Bit rate and CAN Module Clock Frequency = 27 MHz. This clock frequency is the maximum for the DM6437 EVM blocks.

Bit rate	TSEG1	TSEG2	Bit Time	BRP	SJW
250 Kbits/sec	6	2	3	12	1 or 2
500 Kbits/sec	3	1	6	9	1
1 Mbits/sec*	6	2	9	3	1 or 2
2 Mbits/sec*	1	1	4.5	3	ERROR

* 3-time sampling in the DM643x CAN module is not possible at this Bit rate. In the DM643x CAN Setup block, the **SAM** parameter cannot be set to Sample three times.

References. For detailed information on the CAN module, see *TMS320DM643x DMP High-End CAN Controller User's Guide (Rev. A)*, Literature Number SPRU981A, available at the Texas Instruments Web site.

See Also. DM643x CAN Setup, DM643x CAN Transmit

Hardware Issues

In this section...

“Configuring the D.signT DSK-91C111 to Use TCP/IP and UDP” on page 45-102

“Requirements for the DM642 EVM” on page 45-102

“Installing and Configuring the Avnet Board Support Library” on page 45-105

“Continuing Issues with Embedded Coder Software” on page 45-107

Configuring the D.signT DSK-91C111 to Use TCP/IP and UDP

Specific evaluation boards that don't have a build-in Ethernet ports accept the D.signT DSK-91C111 daughter card with the required Texas Instruments TMS320C6000 TCP/IP Stack. To use the D.signT DSK-91C111, change the position of solder point jumper JPINTPOL. Set the jumper to the “b” position from the default “a” position. Refer to your TI TCP/IP Stack User's Guide documentation for additional information about configuring the daughter card.

Requirements for the DM642 EVM

- “DM642 EVM Board Version Identification” on page 45-103
- “Installing Third-party Software” on page 45-104
- “Configuring the Target Hardware Resources pane for Your DM642 EVM” on page 45-105
- “Configuring the DM642 EVM Video ADC Block” on page 45-105

This section provides details about using both the DM642 EVM hardware target and the simulator.

DM642 EVM Board Version Identification

Spectrum Digital released three versions of the DM642 EVM board. Before generating code for the DM642 EVM:

- 1** Determine the board version by looking at the ASSY number on the bottom of the board, or consult the documentation provided with the board.
 - **Version 1** — Original board with 600 MHz DM642, Philips SAA7115 video decoders. ASSY 506840 Rev. D on back of board, 50 MHz oscillator.
 - **Version 2** — Original board with 720 MHz DM642, Philips SAA7115 video decoders. ASSY 506840 Rev. D on back of board, 60 MHz oscillator.
 - **Version 3** — Revised board with 720 MHz DM642, TI TVP5146/5150 video decoders and HD filters. ASSY 507340 Rev. B on back of board, 60 MHz oscillator.
- 2** Press **Ctrl+E** to open the Configuration Parameters dialog box.
- 3** Select the **Coder Target** pane in Configuration Parameters dialog box.
- 4** Under to the Target Hardware Resources tab, set the **Board** parameter to specify the board version: SD DM642 EVM V1, SD DM642 EVM V2, or SD DM642 EVM V3
- 5** If your model contains a DM642 EVM Video ADC block, open the block and set the **Decoder type** parameter to:
 - SAA7115 for board version 1 and 2
 - TVP5146 for board version 3

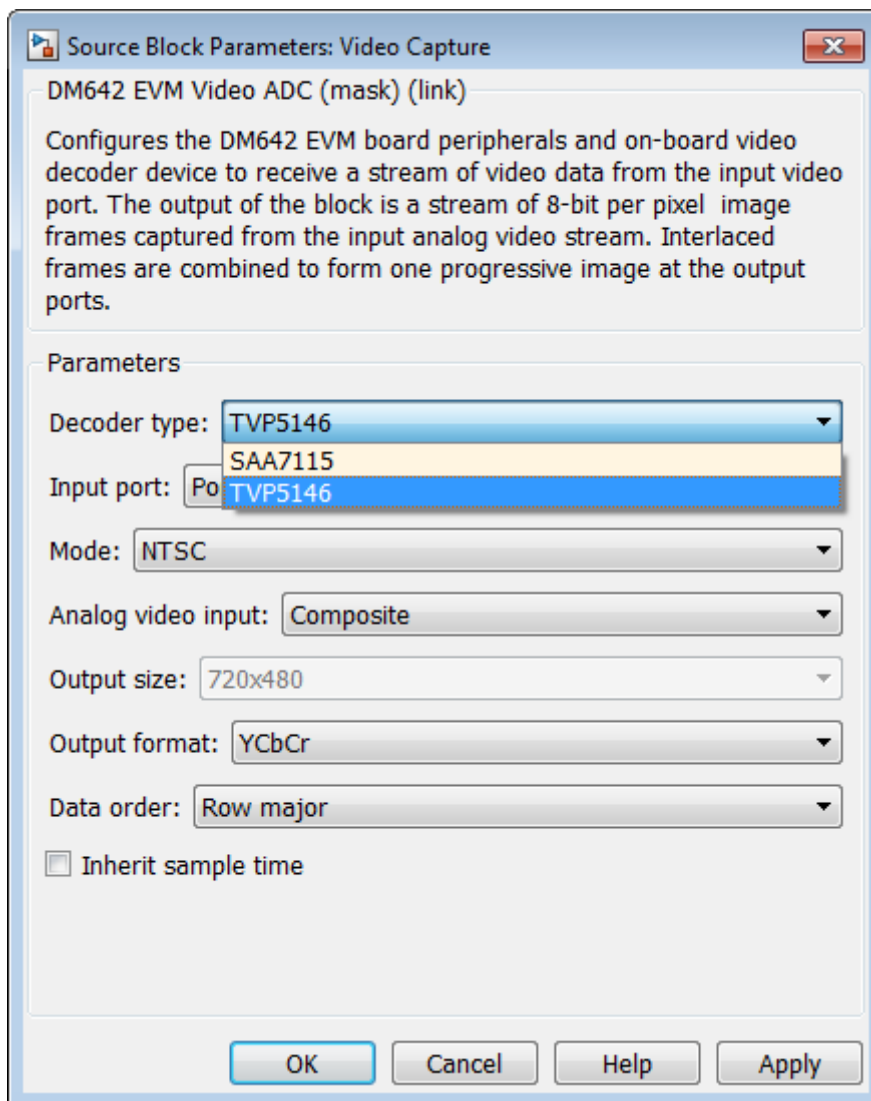

Installing Third-party Software

After determining the board version, install the *supported* versions of the third-party software for that board version. See the “System Requirements” on page 45-5 for the Embedded Coder software.

Configuring the Target Hardware Resources pane for Your DM642 EVM

Set the **CPU Clock** parameter in the Target Hardware Resources pane to match the version of the DM642EVM board you are using:

- For Version 1 boards, set the value of the **CPU Clock** parameter to 600.
- For Version 2 and Version 3 boards, set the value of the **CPU Clock** parameter to 720.

Configuring the DM642 EVM Video ADC Block

If you have a DM642 EVM Version 2 or 3 board:

- Update the video drivers in your CCS IDE installation folder and
- Set the **Decoder type** parameter to TVP5146.

Installing and Configuring the Avnet Board Support Library

- “Preface” on page 45-105
- “Installing the Avnet Board Support Library” on page 45-105
- “Setting the MATLAB Environment” on page 45-106
- “For Spectrum Digital DM6437EVM Users” on page 45-107
- “Verifying Your Installation” on page 45-107

Preface

The Avnet S3ADSP DaVinci evaluation platform is designed for joint software and hardware design. It brings the Texas Instruments TMS320DM6437 DSP and Xilinx Sparta-3A FPGA together. This chapter provides an overview of the board, and instructions for installing, configuring, and using the Avnet S3ADSP DM6437.

Installing the Avnet Board Support Library

Download and install the current Avnet Board Support Package for Simulink (Avnet BSL), available from the Avnet Web site, www.avnet.com. Doing so

creates environment variables that the Embedded Coder software uses to locate files in the Avnet BSP.

Make a note of the installation folder for the Avnet BSL.

Setting the MATLAB Environment

The Embedded Coder software uses environment variables to locate files in the Avnet BSP.

The MathWorks utility, `setTgtEnv.m`, automatically maps the following environment variables (where `<Avnet BSL>` is the Avnet BSL installation folder):

- `PSP_EVMDM6437_INSTALLDIR`: must be mapped to “`<Avnet BSL>\psp`”
- `CSLR_DM6437_INSTALLDIR`: must be mapped to “`<Avnet BSL>\psp\pspdriers\soc\dm6437\dsp\inc`”
- `NDK_INSTALL_DIR`: must be mapped to “`<Avnet BSL>\ndk`”

Run `setTgtEnv` by entering the following command at the MATLAB command prompt: `setTgtEnv('avnet_s3adsp_dm6437')`

If you installed the Avnet BSL prior to installing the MathWorks BSL, the utility detects the `AVNET_S3ADSP_DM6437_INSTALLDIR` environment variable created by the Avnet BSL installer. It will automatically set the environment variables above based on the path stored in the `AVNET_S3ADSP_DM6437_INSTALLDIR` environment variable. You should see the following messages printed on the MATLAB command window:

```
Setting environment variable "PSP_EVMDM6437_INSTALLDIR" to  
C:\avnet_s3adsp_dm6437_1_06\psp"
```

```
Setting environment variable "CSLR_DM6437_INSTALLDIR" to  
C:\avnet_s3adsp_dm6437_1_06\psp\pspdriers\soc\dm6437\dsp\inc"
```

```
Setting environment variable "NDK_INSTALL_DIR" to  
C:\avnet_s3adsp_dm6437_1_06\ndk"
```

If automatic mapping fails, the script will prompt you to browse for the “avnet_s3adsp_dm6437_version.txt” file stored in the top-level Avnet BSL installation folder. If so, browse for the file and click the **Open** button. This will set the required environment variables.

For Spectrum Digital DM6437EVM Users

If you have a Spectrum Digital DM6437EVM board together with an Avnet S3ADSP DM6437 board, setting environment for the Avnet board as explained in section 2.3 will override DM6437EVM environment setup. To revert back to DM6437EVM environment after using Avnet board, execute the following at the MATLAB command prompt: `setTgtEnv('dm6437evm')`

Follow the instructions printed on the MATLAB command window to complete environment configuration. To go back and forth between DM6437EVM environment and Avnet S3ADSP DM6437 environment, use the `setTgtEnv` script with the right platform name specified as the argument.

Verifying Your Installation

Open the Avnet S3ADSP Board Support Library by entering the following command at the MATLAB command prompt: `avnet_s3adsp_dm6437` This opens the **Avnet Spartan-3A DSP DaVinci Evaluation Platform Board Support Library**. You have completed installing and configuring the MathWorks and Avnet Board Support Libraries. You are ready to start using the Avnet S3ADSP DaVinci evaluation platform.

Continuing Issues with Embedded Coder Software

This section details some target operations that you should know about as you use Embedded Coder software.

- “Setting the Clock Speed on the C6713 DSK” on page 45-108
- “Simulink Stop Block Works Differently When Not Using DSP/BIOS Features” on page 45-109
- “Installing Third-Party Embedded Coder” on page 45-109

Setting the Clock Speed on the C6713 DSK

The C6713DSK PLL is not automatically set to the right CPU Clock frequency when you try to target the board. When you power-up your DSK, it runs at a clock speed of 50 MHz. However, the C6713 is capable of running at 225 MHz.

If you generate code incorporating the DSP/BIOS real-time operating system, the PLL is automatically configured for you at run-time to use the right clock speed. If you are not using DSP/BIOS in your project, you must manually configure the PLL to the right clock rate before running your code.

Setting the PLL to Drive the CPU at 225 MHz. To set the C6713 DSK PLL to drive the CPU at 225 MHz, perform the following steps. Be sure you have defined your GEL file for your DSK in the Setup Utility for CCS IDE.

- 1 Launch Code Composer Studio.
- 2 Open your C6713 DSK project with the GEL file.
- 3 Select **GEL > Resets > InitPLL** from the menu bar in CCS IDE.

To make this happen whenever you open Code Composer Studio to use your C6713 DSK, edit the file `\ti\IDE_Obj\gel\dsk6713.gel`. Add the following command to the `StartUp()` function:

```
init_pll();
```

This tells the GEL file to initialize the PLL to operate at 225 MHz.

On the DM642 EVM, ADC-DAC Loopback Displays An RGB Image Incorrectly After Power-Up. When you set up the DM642 EVM to use loopback from the ADC to the DAC, the DAC block does not faithfully reproduce the colors in the captured image immediately after you power up the board.

To get a clean image, reload the program to the target and run the program again. This also happens with the examples Texas Instruments ships with the DM642 EVM product.

Simulink Stop Block Works Differently When Not Using DSP/BIOS Features

If you are using the Simulink Stop block in your model, but you are not using DSP/BIOS features, your model might take longer to stop when it is running on the target than if you are using DSP/BIOS.

The condition the model uses to detect the stop processing flag is different when you do not use DSP/BIOS. The result is that the model may not detect and respond to the flag as promptly, taking longer to stop the running model on the target hardware.

Installing Third-Party Embedded Coder

For a list of required third-party target packages, with version numbers, see the Embedded Coder System Requirements page at <http://www.mathworks.com/products/target-package/requirements.html>.

When you install one or more of the third-party target packages listed below, perform a default installation using the installation path provided for that package, and perform additional steps given.

This documentation uses placeholders for portions of the installation path that may vary by software version or environment. Please replace the placeholders with the path information for your software environment. For example, if the CCS IDE installation path is `C:\CCStudio_v3.3`, then enter `C:\CCStudio_v3.3\boards\evmdm642` instead of `<CCStudio_vn.n>\boards\evmdm642`.

Placeholders:

- `<CCStudio_vn.n>` — The installation path for Code Composer Studio
- `<n.n>` — Version-specific path information

Note If you do not use the default installation paths, update the following parameters:

- **Libraries** and **Include paths** under the Target Hardware Resources tab
- **TCP/IP stack installation directory** parameter in the C6000 IP Config block

Otherwise, the software produces error messages when you attempt to generate code.

DM642EVM Version 3 Board.

- Spectrum Digital EVMDM642 Board Support Package — <CCSvn.n>\boards\evmdm642
- TI's Network Developer's Kit (NDK) — <CCSvn.n>\C6000\NDK

DM642EVM Version 1 & 2 Boards.

- Spectrum Digital EVMDM642 Board Support Package — <CCSvn.n>\boards\evmdm642
- Device Driver Developer's Kit (DDK) — <CCSvn.n>\ddk
- TI's Network Developer's Kit (NDK) — <CCSvn.n>\C6000\NDK

DM6437EVM.

- Spectrum Digital DM6437EVM DVSDK RTM — Install anywhere. TI recommends using the root path of your main drive. For example, C:\dvsdk_<n.n>

Also, set the following environment variables, replacing DVSK with the DVSDK installation path (e.g., C:\dvsdk_<n.n>).

The first time you generate code, the Embedded Coder™ software prompts you to locate specific files in the DVDSK folders and creates environment variables mapped to the location of required folders. For example, the application

creates an environment variable called CSLR_DM6437_INSTALLDIR for the path of the Register Layer Chip Support Library.

C6455DSK. Spectrum Digital DSK6455/EVM6455 Target Content Package — <CCSvn.n>\boards\dsk6455_v<n.n>

Network Developer's Kit NDK — <CCSvn.n>\C6000\NDK

C6727PADK. Lyrtech's PADK Software — Install anywhere.

TI's C672x Chip Support Libraries (CSL) — Extract the three C672x CSL components from **sprc223.zip** to <CCSvn.n>\boards\C6727PADK.

TI's System Patch Code, FastRts(V<n.n>)/DSPLIB (V<n.n>) — <CCSvn.n>\boards\C6727PADK\sprc203

After installation, the path structure for the C672x CSL libraries should resemble the following figure:

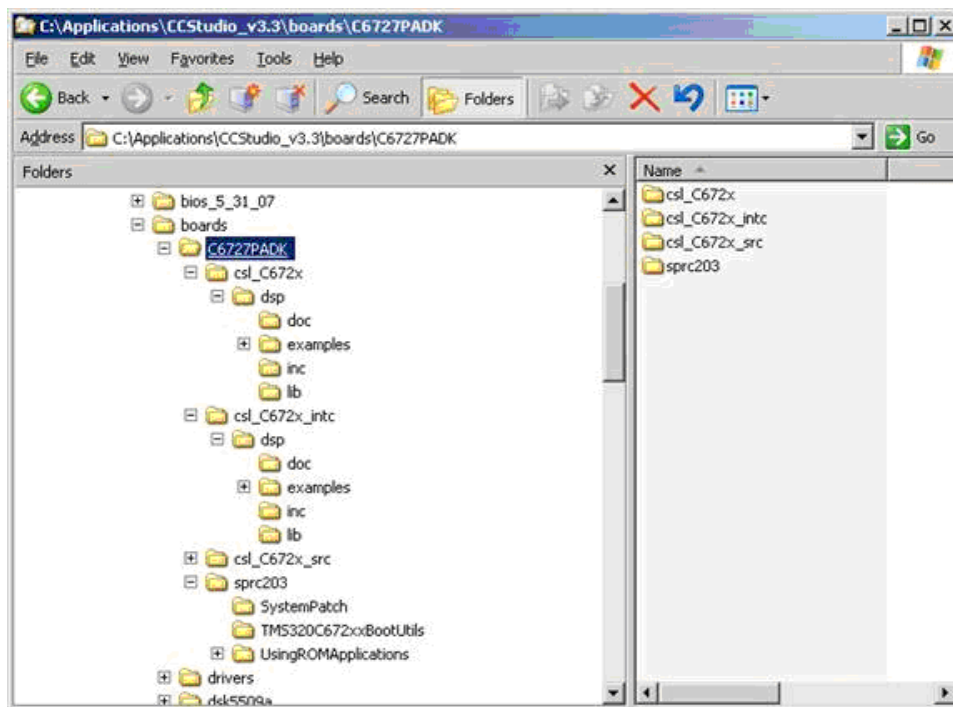

The PADK Software installer automatically sets the PADK_DIR environment variable with the installation path.

The first time you generate code, the Embedded Coder™ software prompts you to locate the following files under <CCSVn.n>\boards\C6727PADK\ and sets the environment variables accordingly:

- \$(CSL_C672x_INSTALLDIR)\lib\cs1_C6727.lib
- \$(CSL_C672x_INTC_INSTALLDIR)\lib\cs1_C672x_intc.lib
- \$(SYSPATCH_C672x_INSTALLDIR)\applySystemPatch.obj

You have completed installation of the third-party software.

Working with Wind River VxWorks RTOS

- “Overview of Support for Wind River VxWorks Target” on page 46-2
- “Building and Running Embedded Software on VxWorks Target” on page 46-4
- “Working with Other Processors” on page 46-9
- “Schedulers” on page 46-10

Overview of Support for Wind River VxWorks Target

Using the XMakefiles feature, you can automatically generate and integrate code with both VxWorks 6.7 and VxWorks 6.8. This support includes:

- Real-time scheduler
- Non real-time (free-running) scheduler
- Single-tasking and multitasking modes

You can use the following MathWorks software features to verify that the target software you create for VxWorks:

- External mode simulation
- Processor-in-the-loop simulation over TCP/IP (TCP/IP PIL)

Additionally, the Simulink Library Browser contains a new VxWorks block library, `vxworkslib`, with the following blocks:

- VxWorks Task
- UDP Receive
- UDP Send

You can find `vxworkslib` in the Simulink Library Browser under **Embedded Targets > Operating Systems > VxWorks**.

In this release, Embedded Coder cannot generate IDE projects for the Wind River Diab or GNU tool chains. Instead, use the XMakefile feature to generate makefiles, source code, and related files from your model. You can then use those files with to build, load, and run your embedded software on VxWorks. For more information, see “IDE Projects” on page 35-16 and “Makefiles for Software Build Tool Chains” on page 35-21.

The XMakefile feature includes the following configuration files:

- `wrsdiab_arm9_vxworks67_rtp`: Wind River Systems DIAB Compiler & ARM 9 & VxWorks 6.7 & real-time process applications

- `wrsdiab_arm9_vxworks67_rtp_so`: Wind River Systems DIAB Compiler & ARM 9 & VxWorks 6.7 & real-time process applications with shared object
- `wrsdiab_hostsim_vxworks67_rtp`: Wind River Systems DIAB Compiler & VxWorks Host Simulator & VxWorks 6.7 & real-time process applications
- `wrsdiab_hostsim_vxworks67_rtp_so`: Wind River Systems DIAB Compiler & VxWorks Host Simulator & VxWorks 6.7 & real-time process applications with shared object
- `wrsdiab_hostsim_vxworks68_rtp`: Wind River Systems DIAB Compiler & VxWorks Host Simulator & VxWorks 6.8 & real-time process applications
- `wrsdiab_hostsim_vxworks68_rtp_so`: Wind River Systems DIAB Compiler & VxWorks Host Simulator & VxWorks 6.8 & real-time process applications with shared object
- `wrsgnu_arm9_vxworks67_rtp`: Wind River Systems GNU Compiler & VxWorks Host Simulator & VxWorks 6.7 & real-time process applications
- `wrsgnu_hostsim_vxworks67_rtp`: Wind River Systems GNU Compiler & VxWorks Host Simulator & VxWorks 6.7 & real-time process applications with shared object
- `wrsgnu_hostsim_vxworks68_rtp`: Wind River Systems GNU Compiler & VxWorks Host Simulator & VxWorks 6.8 & real-time process applications with shared object

For more information, see “Makefiles for Software Build Tool Chains” on page 35-21.

For an example of developing embedded software for VxWorks, see the Code Generation and Verification example.

Building and Running Embedded Software on VxWorks Target

In this section...
“Install and Set Up the Wind River Development Environment” on page 46-4
“Setting VxWorks Environment Variables and Starting MATLAB” on page 46-5
“Setting Up XMakefile for VxWorks Target” on page 46-6
“Customizing XMakefile to Automatically Download and Build Your Software” on page 46-7
“Prepare Your Model for VxWorks Target and Makefiles” on page 46-8
“Build Your Embedded Software” on page 46-8

This tutorial shows you how to use the XMakefile feature in your MathWorks software to build and run embedded software for VxWorks. For more information about XMakefile, see “Makefiles for Software Build Tool Chains” on page 35-21.

Install and Set Up the Wind River Development Environment

Set up VxWorks software and hardware on your host and target:

- 1** Install Wind River Workshop on the host.
- 2** Set up host-to-target communications.
- 3** Create a VxWorks operating system kernel image on the host.
- 4** Boot the embedded target with the kernel image.

For detailed instructions, consult your Wind River Workshop and VxWorks documentation.

Setting VxWorks Environment Variables and Starting MATLAB

Each time you use VxWorks with your MathWorks software, start by:

- Setting the VxWorks environment variables
- Starting MATLAB

The XMakefiles feature in your MathWorks software uses standard input/output (command line) to start and communicate with the tool chain in Wind River Workbench. Wind River recommends that you set environment variables using the `wrenv` utility each time you start those tools from the command line. For more information, read the `readme.txt` file in the Wind River installation folder, and search the Wind River Workbench help for “Setting Environment Variables With `wrenv`”.

Set the VxWorks environment variables, and then start MATLAB:

- 1** Open a command-line session in Windows or Linux.
- 2** Change folders to the Wind River installation folder. For example, at the Windows command line, enter:

```
cd C:\WindRiver
```

- 3** Run the `wrenv` utility, including `-p` followed by the relative path to the VxWorks platform you are using.

For example, in Windows, enter:

```
wrenv.exe -p vxworks-6.7
```

For example, in Linux, enter:

```
./wrenv.sh -p vxworks-6.7
```

- 4** Start MATLAB. For example, enter:

```
C:\Program Files\MATLAB\R2010a\bin\matlab.exe
```

Setting Up XMakefile for VxWorks Target

The XMakefile feature tells your MathWorks software how to create makefiles for a “configuration”, which is a specific combination of tool chain and embedded target hardware. Some configurations require additional information before you can use them.

Select and complete a configuration for VxWorks:

- 1 Enter `xmakefilesetup` at the MATLAB command prompt. This action opens the XMakefile User Configuration dialog.
- 2 Clear **Display operational configurations only**. This displays the configuration files, including ones that need updated path information.
- 3 Set **Configurations** to a choice that starts with `wrs` and contains `vxworks`, and click **Apply**.
- 4 If the configuration is incomplete, the software displays a series of **Browse For Folder** dialogues that include instructions to provide missing information.
- 5 Examine the **Tool Directories** tab to see if the paths are valid.
- 6 When you have supplied the missing information and the configuration is complete, click **OK** to close the XMakefile User Configuration dialog.

For example, to generate code for VxWorks and an ARM9 processor:

- 1 Enter `xmakefilesetup` on the command line.
- 2 In the XMakefile dialog, clear **Display operational configurations only**, set **Configurations** to `wrsdiab_arm9_vxworks67_rtp`, and click **Apply**.
- 3 When the **Browse For Folder** dialog appears, stating “Select the Wind River Diab compiler binary directory...”, browse and select a path.

For example, you can select a path such as
`C:\WindRiver\diab\5.7.0.0\WIN32\bin`.

- 4 When another **Browse For Folder** dialog appears, stating “Select the Wind River root installation directory...”, browse and select a path.

For example, you can select a path such as C:\WindRiver.

- 5 Examine the **Tool Directories** tab to see if the paths are valid.
- 6 After you complete the update of configuration information, click **OK** to save the updated configuration and close the dialog. The wrsdiab_arm9_vxworks67_rtp configuration is now operational.

Customizing XMakefile to Automatically Download and Build Your Software

Create a customized XMakefile configuration that automatically builds and downloads your embedded software to the VxWorks target.

- 1 Enter `xmakefilesetup` at the MATLAB command prompt. This action opens the XMakefile User Configuration dialog.
- 2 Verify that **Configurations** displays the right configuration, such as `wrsdiab_arm9_vxworks67_rtp` configuration.
- 3 Click **New**, and name the new configuration.
- 4 On the **Post-build** tab:
 - For **Post-build tool**, enter `echo`
 - For **Arguments**, enter the following text *as a single line*:

```
rtpSp \"host:[||MW_XMK_GENERATED_TARGET_REF[E]||]\">
[||MW_XMK_OUTPUT_PATH_REF[E]||]vxscript.txt"
```

- 5 On the **Execute** tab:
 - For **Execute tool**, enter the complete path to the VxWorks simulator executable. For example:

```
C:\WindRiver\vxworks-6.7\host\x86-win32\bin\vxsim.exe
```

- For **Arguments**, enter the following string. Substitute `vxworksimage` with the complete path to the VxWorks operating system kernel image you created earlier:

```
-f vxworksimage -s
"[||MW_XMK_OUTPUT_PATH_REF[E]||]vxscript.txt" &
```

When you enter the path, use double back-slashes. For example:

```
-f C:\\WindRiver\\workspace\\test_img\\default\\vxWorks  
-s "[|||MW_XMK_OUTPUT_PATH_REF[E]|||]vxscript.txt" &
```

Prepare Your Model for VxWorks Target and Makefiles

The Target Hardware Resources pane contains information that your MathWorks software needs to generate code for a specific combination of tool chain and embedded target hardware.

Configure your model to generate code VxWorks by updating the Target Hardware Resources pane.

- 1** Configure your model as described in “Configure Target Hardware Resources” on page 35-3.
- 2** On the Target Hardware Resources pane, set **IDE/Tool Chain** to Wind River Diab/GCC (makefile generation only), and set **Board** to one of the supported processors.

This action sets the **Operating system** parameter to VxWorks.

Build Your Embedded Software

In your model, build your embedded software by entering **CTRL+B**. This action causes your MathWorks software to generate code and makefiles. Then the Wind River tool chain loads and runs the embedded software on the VxWorks target.

Working with Other Processors

The XMakefile feature includes configurations for VxWorks on the ARM9 processor. To generate makefiles for VxWorks running on other processors, such as the ARM9E, ARM10, ARM11, or generic/custom processors, create a new configuration file from an existing one:

- 1** Start the XMakefile dialog by typing `xmakefilesetup` at the command line.
- 2** Look at the options for **Configuration** and select the configuration for your compiler that begins with `wrsdiab_arm9` or `wrsgnu_arm9`. (If you don't see them, clear the **Display operational configurations only** check box.)
- 3** Click **New**, and name the new configuration.
- 4** Update the new configuration with missing information and new arguments. Consult the Wind River documentation for information on which arguments to provide.

Schedulers

Running Target Applications on Multicore Processors

Introduction

This section provides a variation of the process described in “Build and Download to a Multicore Target”.

This section shows you how to:

- Configure a multirate model
- Generate a multithreaded application from that model

So that the resulting application is enabled for concurrent multicore execution on an embedded target running Linux or VxWorks.

This process uses the `idelink_ert.tlc` or `idelink_grt.tlc` system target files, which enable you to:

- Use Embedded Coder Support Package for Xilinx Zynq-7000 Platform to automatically build, download, and run an executable in the Linux environment on the ARM Cortex-A9 processor on the Xilinx Zynq-7000 platform. (makefile-based)
- Use Eclipse IDE to manage projects for Linux targets (Support for this capability is only available on 32-bit host platforms)
- Cross-compile from a Windows host to a Linux target
- Set thread priority using the **Base rate task priority** parameter on the Target Hardware Resources tab.
- Use VxWorks

Note

- For Xilinx Zynq-7000 platform, see “Working with the Xilinx Zynq-7000 Platform”.
 - For VxWorks, see “Building and Running Embedded Software on VxWorks Target” on page 46-4.
-

Looking at a Model

Before setting up your own model, consider the `sldemo_concurrent_execution` example model, which is referenced by “Build and Download to a Multicore Target”.

The `sldemo_concurrent_execution` model is a useful example to look at because:

- The model is partitioned using Model blocks that can potentially execute concurrently.
- You can look at the **Map Blocks To Tasks** pane in the Concurrent Execution window to see how the tasks are configured for concurrent execution.

However, you cannot run an unmodified version of the `sldemo_concurrent_execution` model on an embedded target running Linux or VxWorks.

To prepare the `sldemo_concurrent_execution` as an example model for the “Setting Up the Model” on page 46-13 and “Deploying the Model to Your Target” on page 46-14 topics, first perform the following modifications:

- Update the Plant Model Block
- Update the Compensator Model Block
- Verify that Models are Mapped

These procedures guide you through the processes of discretizing models and matching sample times of blocks with models.

Update the Plant Model Block.

- 1** In the `sldemo_concurrent_execution` model, open the “Plant” Model block: `sldemo_concurrent_execution_plant`
- 2** Discretize the Plant model. Replace the Integrator blocks, “x1” and “x2”, with equivalent discrete time blocks (such as the Discrete Time Integrator block) or use the “Model Discretizer”.
- 3** Prevent modeling constraints by matching the sample time of the “x1” and “x2” blocks with the model: Open the “x1” and “x2” blocks and change the **Sample time** parameters to 0.1. Matching the sample times to the model can also be accomplished using Rate Transition blocks.
- 4** Convert blocks with continuous sample times (**Sample time** = 0) to inherited sample times (**Sample time** = -1). Open the “u1”, “u2” and “x” blocks. For each one, click the Signal Attributes tab, then change **Sample time** to -1.
- 5** Save your changes to the blocks and the model.

Update the Compensator Model Block.

- 1** In the `sldemo_concurrent_execution` model, open the “Compensator” Model block: `sldemo_concurrent_execution_compensator`
- 2** Discretize the Compensator model. Replace the Integrator block, “c”, with an equivalent discrete time block (such as the Discrete Time Integrator block) or use the “Model Discretizer”.
- 3** Prevent modeling constraints by matching the sample time of the “c” block with the top model: Open the “c” block and change the **Sample time** parameters to 0.1. Matching the sample times to the top model, `sldemo_concurrent_execution`, can also be accomplished using Rate Transition blocks.
- 4** Convert blocks with continuous sample times (**Sample time** = 0) to inherited sample times (**Sample time** = -1). Open the “y1”, “y2”, and “x”

blocks. For each one, click the Signal Attributes tab, then change **Sample time** to -1.

- 5 The following parameters cannot both be enabled when you build the model. Open the Configuration Parameters (**Ctrl+E**) and verify that one of the following parameters is disabled (unchecked):
 - **Minimize algebraic loop occurrences**, located on the Model Referencing pane.
 - **Single output/update function**, located on the Code Generation > Interface pane
- 6 Save your changes to the blocks and the model.

Verify that the Models are Mapped. Open and inspect the Task editor to see if the models are mapped:

- 1 In the Simulink model editor for `sldemo_concurrent_execution`, select **View > Model Explorer (Ctrl + H)**.
- 2 In Model Explorer, expand the top model, `sldemo_concurrent_execution`.
- 3 Under the top model, select **Configuration (Active)**, then click **Concurrent Execution** in the second column. In the third column, click the **ConfigureTasks and Map Blocks to Tasks** button.
- 4 Click **Map Blocks To Tasks**. The mapping of the models should conform to the guidelines provided by “Design Considerations”.

The `sldemo_concurrent_execution` example model is ready for you to use in “Setting Up the Model” on page 46-13 and “Deploying the Model to Your Target” on page 46-14.

Setting Up the Model

This procedure explains how to set up a model for a multicore processor.

- 1 Apply the recommendations in “Design Considerations” to your multirate Simulink model. Or, refer to the `sldemo_concurrent_execution` example model.

- 2 Configure your model for your IDE, tool chain, and target hardware, as described in “Configure Target Hardware Resources” on page 35-3.
- 3 In Configuration Parameters, set the **Operating System** parameter to Linux or VxWorks.
- 4 If your model uses a Rate Transition block to transition between rates, then open the Rate Transition block and clear the **Ensure deterministic data transfer** check box so that the block uses the most recent data available.
- 5 Configure the model for concurrent execution:
 - a In the Simulink model editor, select **View > Model Explorer (Ctrl + H)**.
 - b In Model Explorer, expand the top model.
 - c Under the top model, right click **Configuration (Active)** and select **Convert to Configuration for Concurrent Execution**. (In the sldemo_concurrent_execution example model, this step has already been performed.)
- 6 Repeat steps 4 through 5 for each referenced model in the model hierarchy that you want to run with concurrent execution.
- 7 Select the configuration set of the model at the top of the model hierarchy. In the second column, select the **Concurrent Execution** node. A Concurrent Execution pane appears in the third column. (In the sldemo_concurrent_execution example model, this step has already been performed.)
- 8 In the Concurrent Execution pane in the third column, select the **This is the top of the model hierarchy** check box, and click the **ConfigureTasks and Map Blocks to Tasks** button. (In the sldemo_concurrent_execution example model, this step has already been performed.)
- 9 The Concurrent Execution configuration parameters dialog is displayed. Click **Apply**.

Deploying the Model to Your Target

In your model, click the build button or enter **Ctrl+B**. The software performs the actions you selected for **Build action** in the Configuration Parameters dialog, on the Code Generation > Coder Target pane.

For more information on the structure of the code, please refer to “Build and Download to a Multicore Target”. As mentioned in that section, the coder product generates target-dependent code for thread creation, thread synchronization, interrupt service routines, and signal handlers and data transfer. For each periodic task, Simulink Coder combines the output and update methods of the blocks mapped to that task and binds these methods to a target-specific thread.

Note The `idelink_ert.tlc` or `idelink_grt.tlc` system target files do not support Continuous times.

Generated Code

For `idelink_ert.tlc` or `idelink_grt.tlc` system target files, the generated code from a mapped model creates a thread for each task and automatically leverages the threading APIs supported by the operating system running on the target.

- If the target platform is running Windows , the generated code will use Windows threads.
- If the target platform is running Linux or VxWorks , the generated code will use POSIX threads (pthreads).

The following table summarizes the differences in the generated code between the target platforms.

Aspect of Concurrent Execution	Linux	VxWorks
Periodic triggering event	POSIX timer	POSIX timer
Aperiodic triggering event	POSIX real-time signal	POSIX real-time and non-real-time signal

Aspect of Concurrent Execution	Linux	VxWorks
Aperiodic trigger	For blocks mapped to an aperiodic task: thread waiting for a signal For blocks mapped to an aperiodic trigger: signal action	For blocks mapped to an aperiodic task: thread waiting for a signal. For blocks mapped to an aperiodic trigger: signal action
Threads	POSIX	POSIX
Thread priority	Based on Base rate task priority parameter	Based on Base rate task priority parameter
Example of overrun detection	Yes	Yes

The software checks that data transfer between concurrently executing tasks behave as described in Data Transfer Options. The software checks data transfer using the following APIs on supported targets.

API	Linux Implementation	VxWorks
Data protection API	<ul style="list-style-type: none"> • pthread_mutex_init • pthread_mutex_destroy • pthread_mutex_lock • pthread_mutex_unlock 	<ul style="list-style-type: none"> • pthread_mutex_init • pthread_mutex_destroy • pthread_mutex_lock • pthread_mutex_unlock
Synchronization API	<ul style="list-style-type: none"> • sem_init • sem_destroy • sem_wait • sem_post 	<ul style="list-style-type: none"> • sem_open • sem_unlink • sem_wait • sem_post

Work with Xilinx Zynq Platform

- “Install Support for Xilinx® Zynq® Platform” on page 47-2
- “Open Block Library for Xilinx® Zynq® Platform” on page 47-5
- “Build and Run Executable on Xilinx® Zynq® Platform” on page 47-7
- “Stop or Restart Executable Running on Xilinx® Zynq® Platform” on page 47-14
- “Tune and Monitor Executable Running on Xilinx® Zynq® Platform” on page 47-15
- “Set up Xilinx® Zynq® Platform and Software” on page 47-22
- “Get IP Address of Xilinx® Zynq® Platform” on page 47-25
- “Open Serial Command-line Session with Xilinx® Zynq® Platform” on page 47-27

Install Support for Xilinx Zynq Platform

You can add support for the Xilinx Zynq-7000 platform to the Embedded Coder product by installing *Embedded Coder Support Package for Xilinx Zynq-7000 Platform*.

This support package:

- Enables the Embedded Coder product to work with Xilinx ISE Design Suite and Xilinx Zynq-7000 platform
- Adds a Simulink block library named *Embedded Coder Support Package for Xilinx Zynq-7000 Platform*
- Provides example tutorials that show you how to use this support package

When you have finished installing the support package, you can use the following capabilities with Xilinx Zynq-7000 platform:

- Multitasking code generation that uses POSIX threads (Pthreads) for concurrent execution on ARM cores running Linux (“Scheduler” on page 41-4)
- Automated makefile-based software build, download, and run on hardware (“Build and Run Executable on Xilinx® Zynq® Platform” on page 47-7)
- Tuning and monitoring the executable running on the hardware from a Simulink model (“Host/Target Communication”)
- Using Model block to reference other models (“Model Reference”)
- Processor-in-the-Loop (PIL) simulation using Model blocks and a TCP/IP connection (“Processor-in-the-Loop (PIL) Simulation” on page 36-2)
- PIL-based execution profiling (“Execution Profiling during PIL Simulation” on page 36-25)
- UDP Send, UDP Receive blocks for communication, and a Linux Task block management
- Code-replacement library for ARM Cortex-A9 processor (“Code and Operator Replacement”)

Note

- For more information about Support Packages, see “Start Support Package Installer” on page 34-3.
 - If you have the HDL Coder™ product, you can also install *HDL Coder Support Package for Xilinx Zynq-7000 Platform*.
 - PIL simulation and PIL-based execution profiling require single-core execution.
-

To install Embedded Coder Support Package for Xilinx Zynq-7000 Platform:

- 1** Set up your hardware and software, as described in “Set up Xilinx® Zynq® Platform and Software” on page 47-22.
- 2** In the MATLAB tool strip, click **Add-Ons > Get Hardware Support Packages**.

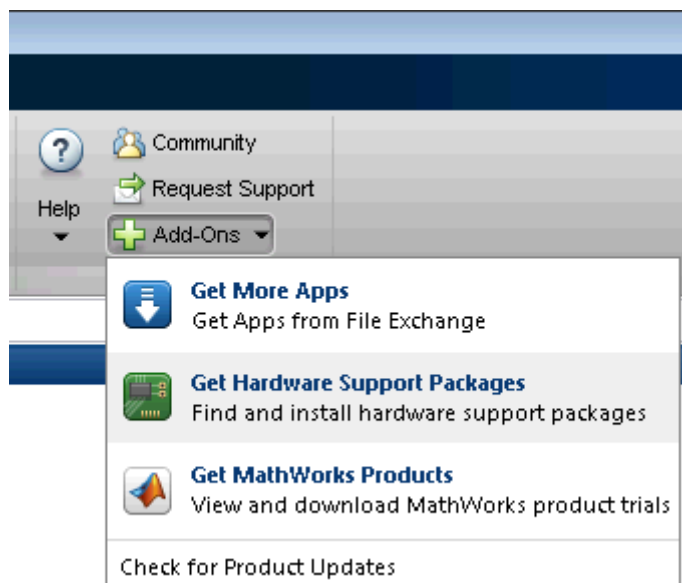

- 3 Follow the instructions provided by Support Package Installer to complete the installation.

In most cases, you can use the default settings. For more information about a particular screen, click the **Help** button.

- 4 When the installation process is complete, Support Package Installer displays examples that show you how to use the Embedded Coder product with Zynq platform.

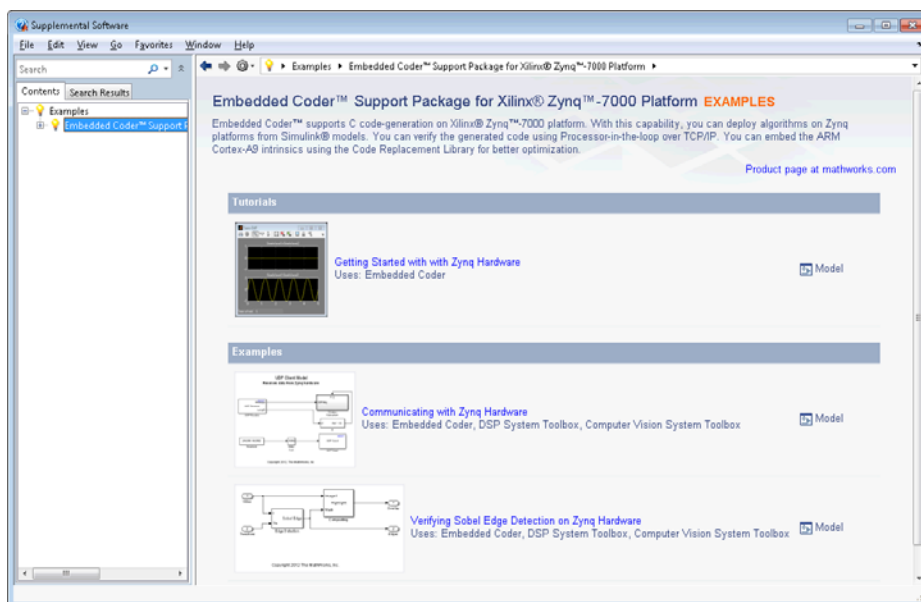

Open Block Library for Xilinx Zynq Platform

After installing the support package, you can open the block library for Zynq platform.

In the MATLAB Command Window, enter `zynqlib` to open the following block library.

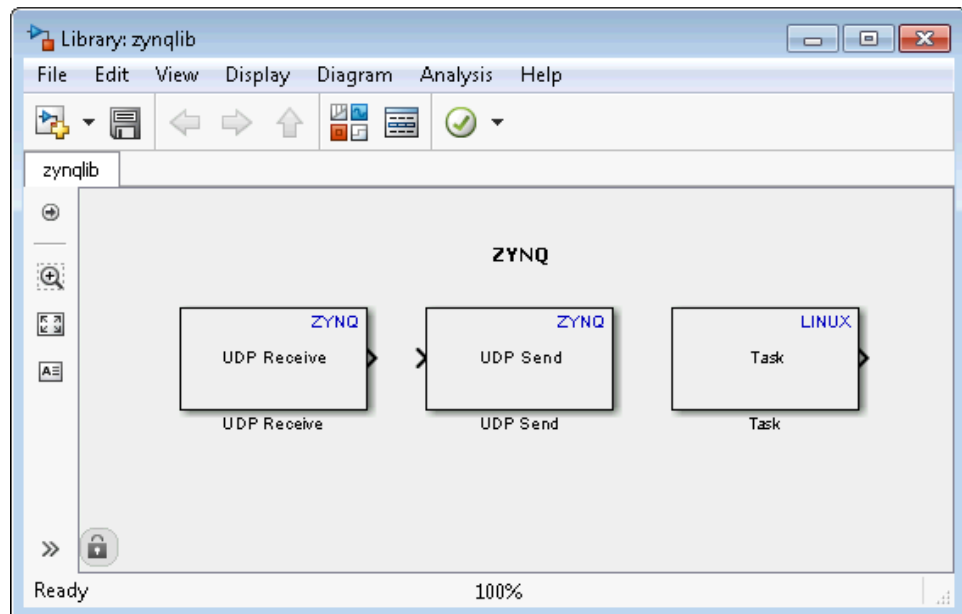

In Simulink Library Browser, locate and select the **Embedded Coder Support Package for Xilinx Zynq-7000 Platform**.

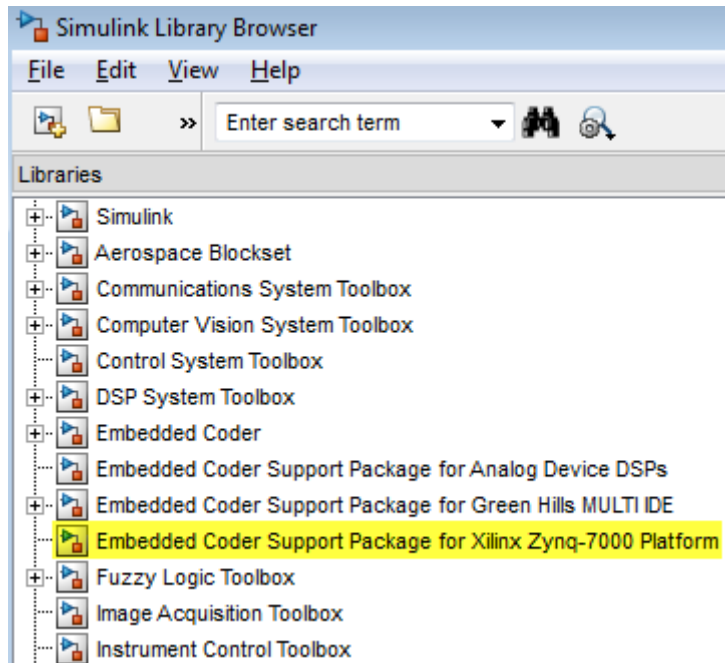

Build and Run Executable on Xilinx Zynq Platform

In this section...

“Set the model Configuration Parameters” on page 47-7

“Set up the XMakefile User Configuration” on page 47-10

“Build and Run the Executable” on page 47-11

“Troubleshooting a Connection Error” on page 47-13

Configure a Simulink model to automatically generate code, build an executable, and then run the executable on your Zynq platform. The executable runs in the Linux environment on the ARM Cortex-A9 processor on the Xilinx Zynq-7000 platform.

Set the model Configuration Parameters

- 1** Create a copy of your model using **File > Save As**. Keep the original model as a backup copy.
- 2** With your model open, press **Ctrl+E** or select **Simulation > Model Configuration Parameters**.
- 3** In Configuration Parameters, select the **Code Generation** pane.
- 4** Display the items under **Code Generation** by clicking the triangle next to it.
- 5** On the **Code Generation** pane, set **System target file** to `idmlink_ert.tlc` or `idmlink_grt.tlc`.

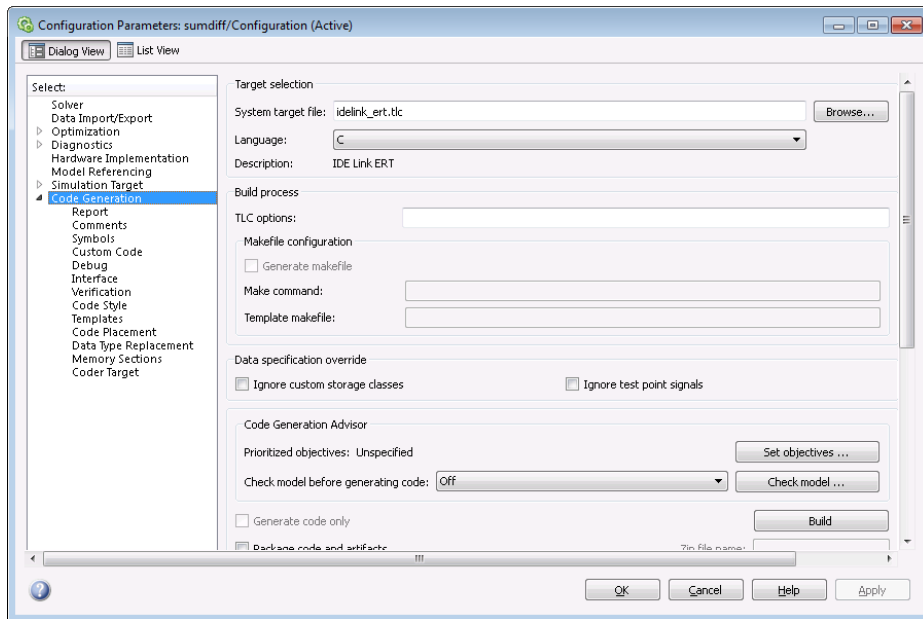

- 6 Select the **Coder Target** pane.
- 7 Select the **Target Hardware Resources** tab.
- 8 Set the **IDE/Tool chain** parameter to Xilinx Zynq Design Suite (makefile generation only).
- 9 Set the **Board** parameter to match your hardware, such as Xilinx Zynq ZC702 evaluation kit.

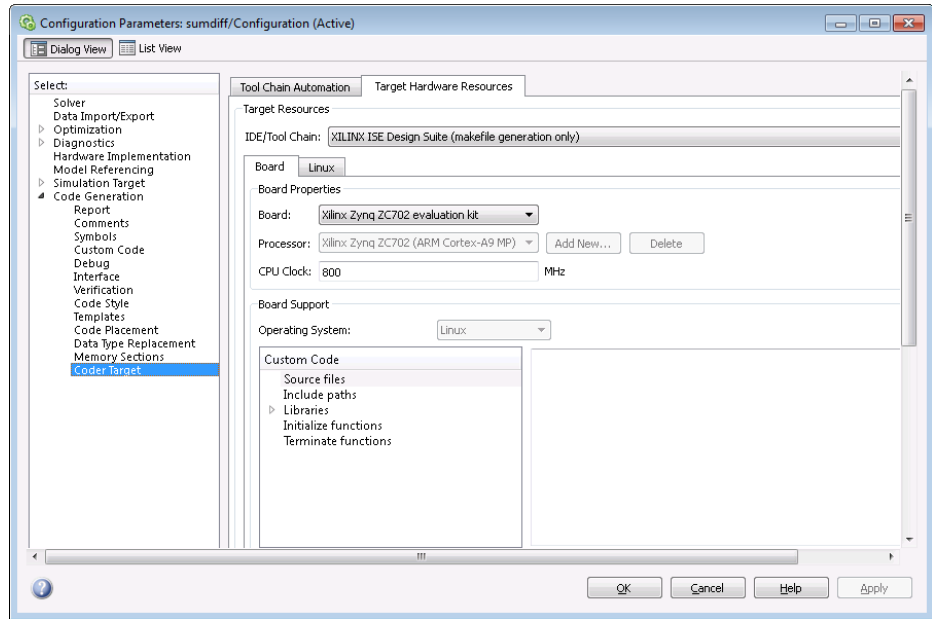

10 Optional: Select the **Tool Chain Automation** tab, and verify that **Build action** is set to **Build_and_execute**.

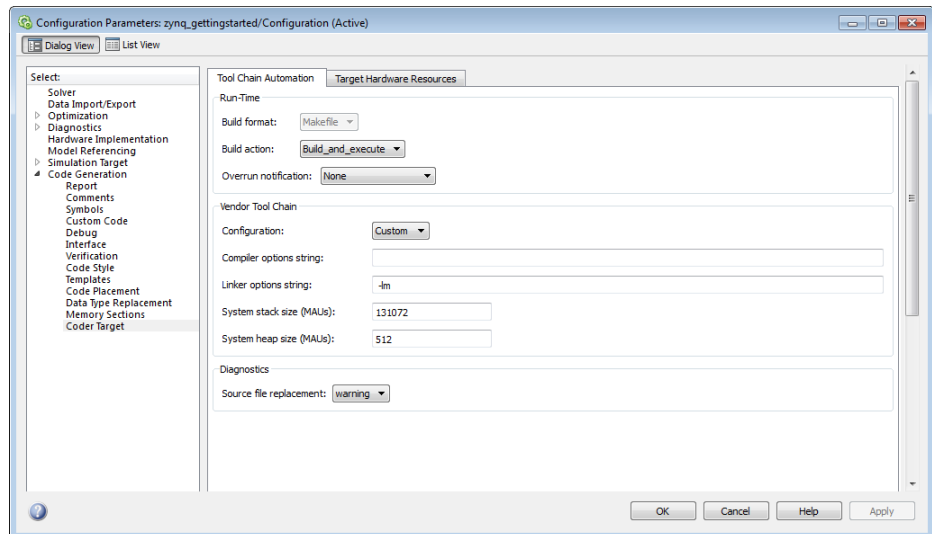

- 11** Optional: By default, the executable runs on a single core of the dual-core ARM Cortex-A9 processor. PIL simulation and PIL-based execution profiling require single-core execution. To configure the executable to run on both cores, see “Running Target Applications on Multicore Processors” on page 46-10.

See also:

- “Model Setup” on page 35-2
- “Code Generation: Coder Target Pane”
- “Code Generation: Target Hardware Resources Pane”

Set up the XMakefile User Configuration

- 1** In the MATLAB Command Window, enter:

```
xmakefilesetup
```

- 2** In the XMakefile User Configuration dialog box, clear the **Display operational configurations only** check box.
- 3** Set the **Configuration** parameter to `xilinx_ise_14_x`.
- 4** When prompted to do so, browse or enter the path of the ISE_DS directory for your Xilinx toolchain. For example: `C:\Xilinx\14.2\ISE_DS`.

This step adds the path to the toolchain settings for the `xilinx_ise_14_x` configuration.

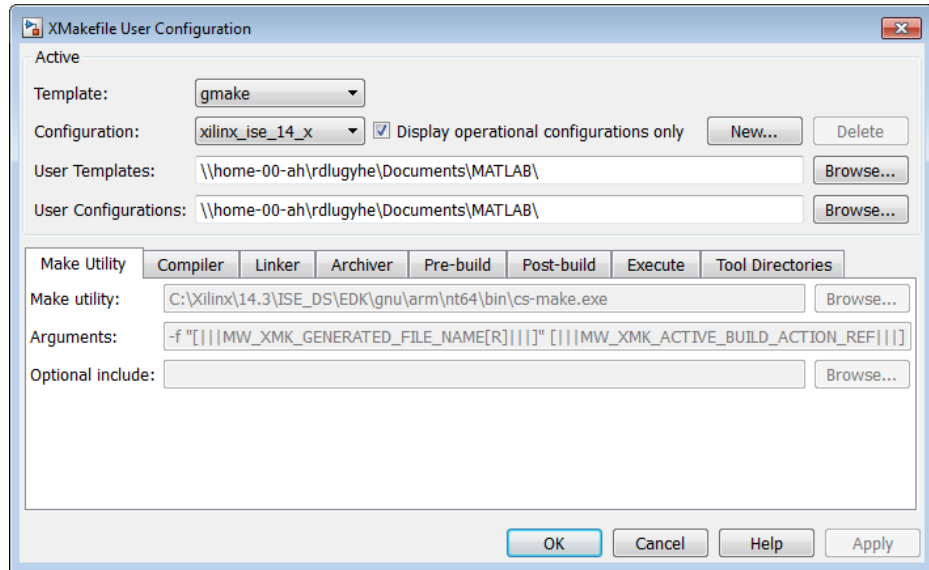

5 Click **OK**.

See also: “Makefiles for Software Build Tool Chains” on page 35-21

Build and Run the Executable

- 1 Save your changes to the model.
- 2 Press **Ctrl+B** or click the build button in your model.

The software performs the action you specified using the **Build action** parameter in “Set the model Configuration Parameters” on page 47-7. If **Build action** is set to **Build_and_execute**, the software builds the executable, then downloads and runs the executable in the Linux environment on the dual-core ARM Cortex-A9 processor on the Xilinx Zynq-7000 platform. By default, the executable runs on a single core. PIL simulation and PIL-based execution profiling require single-core execution. To configure the executable to run on both cores, see “Running Target Applications on Multicore Processors” on page 46-10.

- 3 The software displays a Code Generation Report for the model.

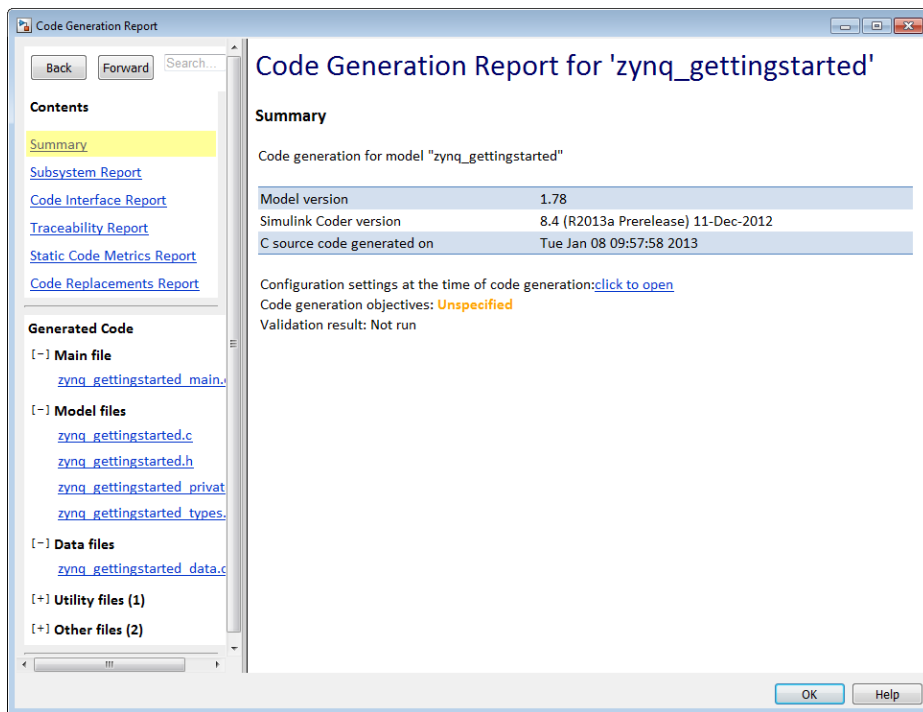

When the software finishes building and downloading the executable to the hardware, it displays a command line status window.

```

C:\Windows\system32\cmd.exe - "C:\Xilinx\14.3\ISE_DS\EDK\gnu\arm\nt64\bin\cs-make.exe" -f "zynq_...
"C:\Xilinx\14.3\ISE_DS\EDK\gnu\arm\nt64\bin\arm-xilinx-linux-gnueabi-gcc.exe" ./MMW
d_main.o -lm -lrt -pthread -o ./CustomMM/zynq_gettingstarted
"Evaluating build target..."
"Evaluating execute target..."
"C:\MATLAB\SupportPackages\R2013aPrerelease01007\zynq/download.bat" "S:\0107Adsphw\
t" "./CustomMM/zynq_gettingstarted"
Connection successful
total 16
drwxr-sr-x  2 6146      10195      1024 Jan  4 00:35 .
drwxr-xr-x  17 6146      2223      1024 Jan  4 00:12 ..
-rwxr-xr-x  1 root      10195      13128 Jan  4 00:47 zynq_gettingstarted
zynq_gettingstarted      12 kB | 12.8 kB/s | ETA: 00:00:00 | 100%
**starting the model**

```

Troubleshooting a Connection Error

- 1 If a connection timeout error occurs while the executable is downloading to the Zynq platform, try these steps:
- 2 In the MATLAB Command Window, enter:

```

bdclose all
clear all
h = zynq()
h.setupZynqHardware

```

These commands close any open models and reload settings from the Zynq platform.

- 3 Build the executable again by pressing **Ctrl+B** or clicking the build button.

Stop or Restart Executable Running on Xilinx Zynq Platform

- 1 In the MATLAB Command Window, create a handle for the connection to the Zynq platform. Enter:

```
h=zynq;
```

Note You do not need to enter `h=zynq`; if a previous instance of a Zynq object such as `h`, is available in the MATLAB Workspace.

- 2 To stop an executable running on the hardware, enter:

```
h.stop('executableName');
```

- 3 To restart a stopped executable, or to run multiple instances of an executable, enter:

```
h.run('executableName');
```

For example:

```
h.stop('zynq_gettingstarted')
```

```
....
```

```
h.run('zynq_gettingstarted')
```

```
ans =
```

```
1
```

Tune and Monitor Executable Running on Xilinx Zynq Platform

In this section...

“Overview of Using External Mode” on page 47-15

“Configure Simulink Model for External Mode” on page 47-16

“Run Executable on Zynq Platform” on page 47-18

“Stop External Mode” on page 47-20

Overview of Using External Mode

You can use External mode to tune parameter values in, and receive data from, the executable while it is running on your hardware.

External mode enables you to tune model parameters and evaluate the effects of different parameter values on the executable while it is running on the hardware. Doing so helps you find the optimal values to achieve desired results. This process is called *parameter tuning*.

External mode accelerates parameter tuning because you do not have to generate code, build, and run the executable each time you change the value of a parameter. You can also use External mode to develop and validate your application using the actual data and hardware for which it is designed. This software-hardware interaction is not available solely by simulating a model.

This workflow lists the tasks usually required to tune parameters with External mode:

- 1** Optional: Place one or more sink blocks in your model. For example, use Display or Scope blocks to visualize data, or use a To File block to log signal data.
- 2** Configure the model to simulate in External mode with the executable.
- 3** Run the executable on the Zynq platform.

- 4** Connect the model on your host computer to the executable running on the Zynq platform.
- 5** Optional: Observe data External mode sends from the executable running on the hardware to the sink blocks in the model on your host computer.
- 6** Change parameter values in the model on your host computer that External mode applies to the executable running on the hardware.
- 7** Find the optimal parameter values by making adjustments and observing the results.
- 8** Save the new parameter values, disable External mode in the model, and save the model.

See also: “Host/Target Communication”

Configure Simulink Model for External Mode

- 1** Verify that you are able to run an executable on the Zynq platform, as described in “Build and Run Executable on Xilinx® Zynq® Platform” on page 47-7.
- 2** In the model, review the default 10 second value of **Simulation stop time** parameter, located on the model toolbar.

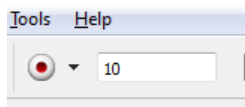

- To simulate in External mode for an indefinite period, enter `inf`.
- To simulate in External mode for a finite period, enter a number of seconds. For example, entering 120 runs the executable on the hardware for 2 minutes.

Note When model stops simulating in External mode, the binary executable stops running on the hardware.

- Optional: To inspect, record, or log data, review the options under the **Record & Inspect Simulation Output** button.

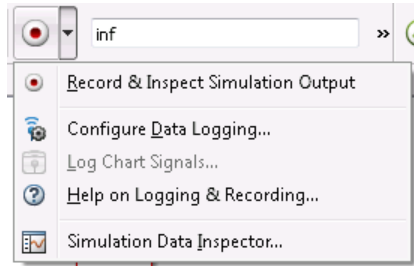

- With your model open, press **Ctrl+E** or select **Simulation > Model Configuration Parameters**.
- In Configuration Parameters, select the **Code Generation** pane.
- Display the items under **Code Generation** by clicking the triangle next to it.
- Select the **Interface** pane.

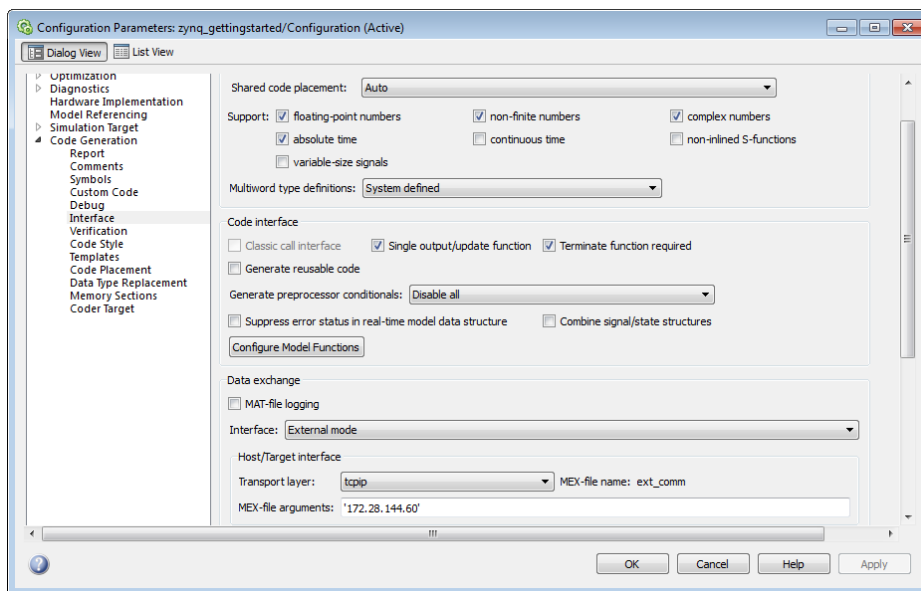

8 On the **Interface** pane, set:

- **Interface** to External mode
- **Transport layer** to tcpip
- **MEX-file arguments** to the IP address of the Zynq platform between single quotes. For example: '172.28.144.60'

9 Click **OK**, and then save the changes to your model.

Tip When you have finished tuning and monitoring your application, disable External mode by setting **Interface** to None.

Run Executable on Zynq Platform

1 Press **Ctrl+B** or click the build button in your model. The coder software generates code, builds an executable, downloads the executable to the hardware, and then runs it.

If your model does not contain a sink block, the MATLAB Command Window displays a warning message. You can disregard this warning or add a sink block to the model.

- 2** In the model, select **Simulation > Mode > External**.
- 3** Select **Simulation > Connect To Target**. This starts the simulation. If your model contains scopes, the scopes on your host computer start plotting data from the executable running on the Zynq platform.
- 4** While the executable is running on the Zynq platform, you can:
 - Change parameter values in the model on your host computer.
 - If your model contains blocks from the Simulink Sinks block library, the sink blocks in the model on your host computer display the values generated by the executable running on the hardware.

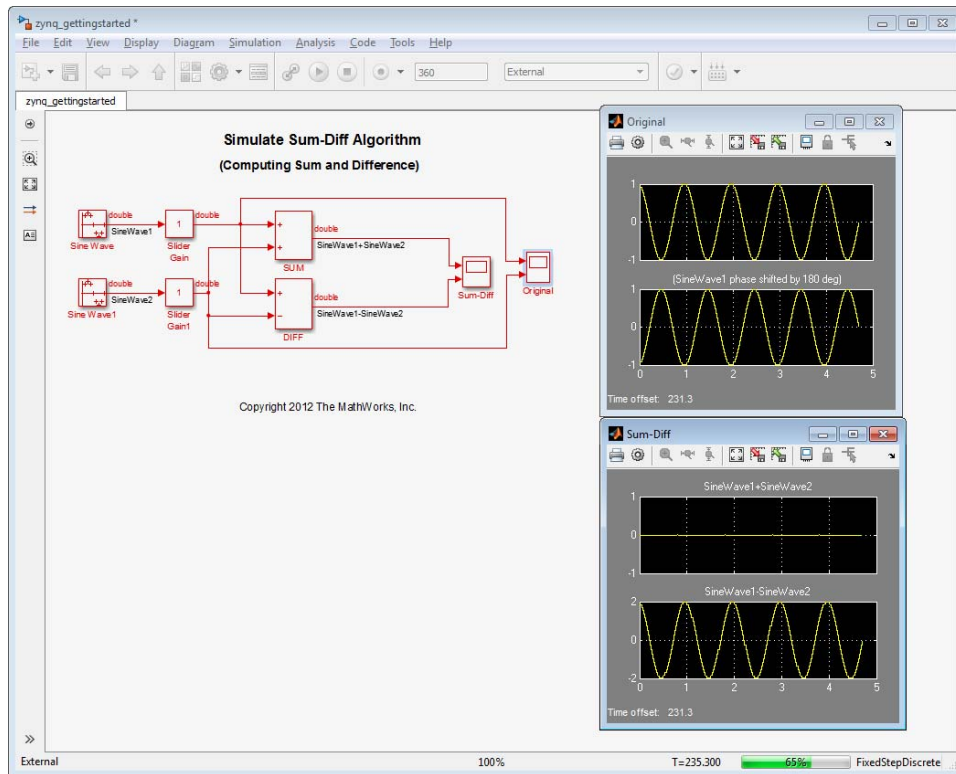

Stop External Mode

To stop the model simulating in External mode, select **Simulation > Stop**, or click the stop button on the model toolbar.



If it is set to a finite period, the **Simulation stop time** parameter stops External mode when the period elapses.

Note When model stops simulating in External mode, the binary executable stops running on the hardware.

Set up Xilinx Zynq Platform and Software

Install Xilinx software and set up the hardware:

- 1** Install a supported version of Xilinx Design Tools, such as ISE Design Suite and Vivado.

For more information about supported versions, visit mathworks.com and search for Xilinx Zynq.

- 2** Set up the physical connections to your Zynq platform. For example, the following illustration shows the connections for the Xilinx Zynq ZC702 evaluation kit.

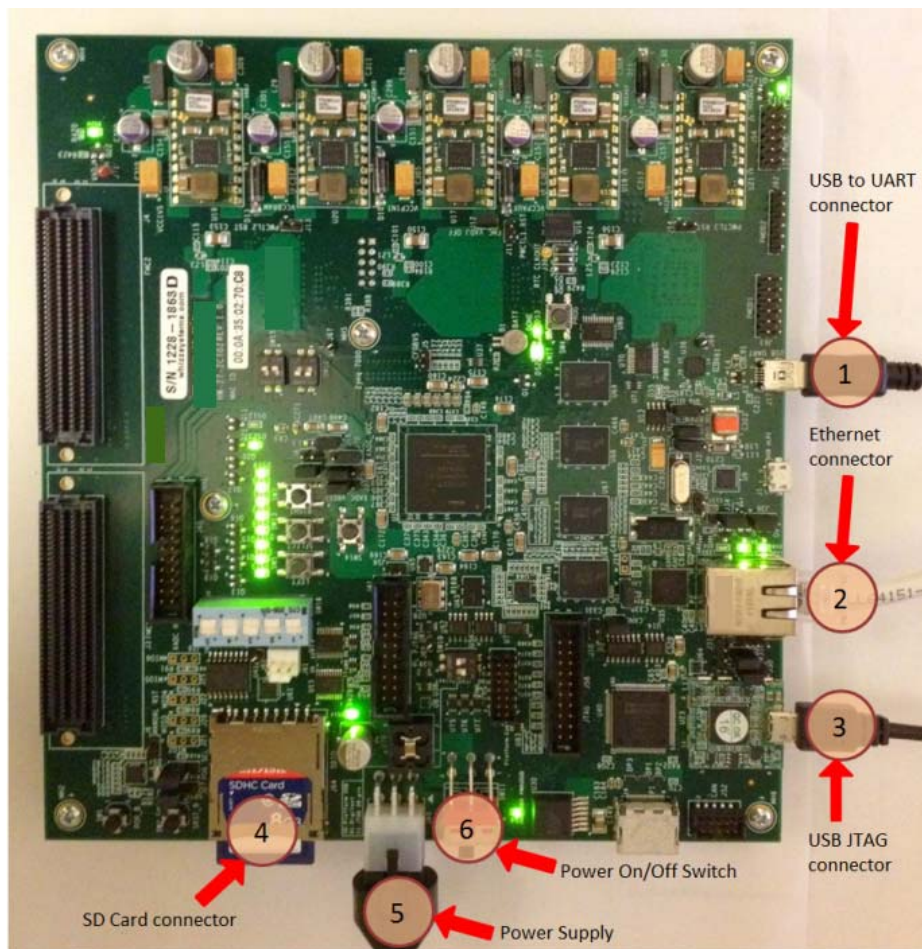

3 In Windows 7, open **Devices and Printers**.

Locate the USB device that connects to the Zynq platform, such as **Silicon Labs CP210x USB to UART Bridge**.

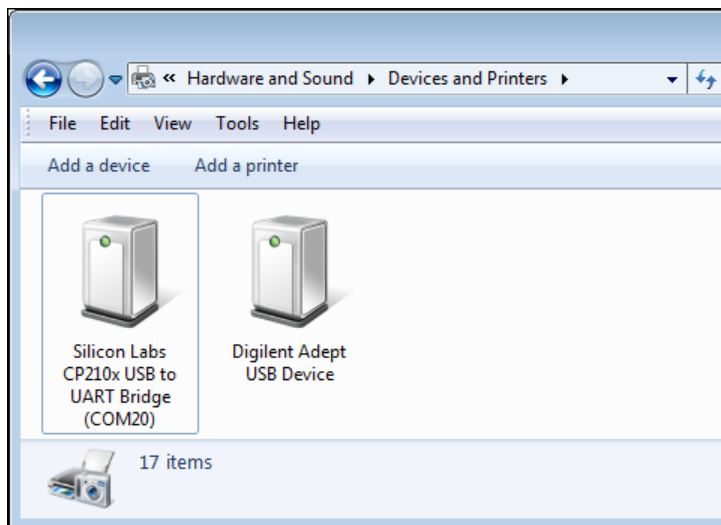

- 4 Verify that the USB devices have drivers and are working correctly. If not, search for the drivers online and install them.

Get IP Address of Xilinx Zynq Platform

You can get the IP address of the Zynq platform from the MATLAB Command Window or using the Linux command line.

This is an optional task that you can use to:

- Run an executable on a different hardware from the previous one you used. (Update the **Host name** parameter as described in “Build and Run Executable on Xilinx® Zynq® Platform” on page 47-7.)
- Open a telnet or SSH session with hardware whose IP settings you do not know.
- Configure the UDP Send block.

To get your hardware’s IP address from the MATLAB Command Window, enter:

```
h = zynq();  
h.setupZynqHardware();
```

```
Connecting to ZC702 using serial port COM20...  
Setup for ZC702 is complete...  
MATLAB will use following settings to communicate with ZC702 board:  
IP Address      :172.28.144.60  
User name       :root  
Password        :root  
Build-directory :/root  
COM port        :COM20
```

To get your hardware’s IP address from the Linux command line:

- 1** Access the Linux command line on the Zynq platform as described in “Open Serial Command-line Session with Xilinx® Zynq® Platform” on page 47-27.
- 2** At the Linux command line, enter: `ifconfig`
- 3** Locate the `eth0` device, and get the value of `inet addr` from the command-line output. For example:

```
zynq> ifconfig
```

```
eth0      Link encap:Ethernet  HWaddr 00:0A:35:00:01:22
          inet addr:172.28.144.60  Bcast:172.28.144.255  Mask:255.255.255.0
          UP BROADCAST RUNNING MULTICAST  MTU:1500  Metric:1
          RX packets:26581 errors:5 dropped:0 overruns:0 frame:0
          TX packets:106 errors:0 dropped:0 overruns:0 carrier:0
          collisions:0 txqueuelen:1000
          RX bytes:2953666 (2.8 MiB)  TX bytes:11772 (11.4 KiB)
          Interrupt:54 Base address:0xb000

lo        Link encap:Local Loopback
          inet addr:127.0.0.1  Mask:255.0.0.0
          UP LOOPBACK RUNNING  MTU:16436  Metric:1
          RX packets:0 errors:0 dropped:0 overruns:0 frame:0
          TX packets:0 errors:0 dropped:0 overruns:0 carrier:0
          collisions:0 txqueuelen:0
          RX bytes:0 (0.0 B)  TX bytes:0 (0.0 B)
```

Related Examples

- “Open Serial Command-line Session with Xilinx® Zynq® Platform” on page 47-27
- “Build and Run Executable on Xilinx® Zynq® Platform” on page 47-7
- “Get IP Address of Xilinx® Zynq® Platform” on page 47-25

Open Serial Command-line Session with Xilinx Zynq Platform

You can configure and open a command-line session with the hardware.

This is an optional task that you can use to:

- View the standard output while the hardware boots.
- Get or set the IP address, as described in “Get IP Address of Xilinx® Zynq® Platform” on page 47-25 topic.

To open a serial connection to your hardware:

- 1** Set up your hardware as described in “Set up Xilinx® Zynq® Platform and Software” on page 47-22.
- 2** In the MATLAB Command Window, start PuTTY by entering:

```
h = zynq;  
h.setupZynqHardware();  
h.openShell('serial');
```

For example:

```
h = zynq;  
h.setupZynqHardware();
```

```
Connecting to ZC702 using serial port COM20...
```

```
Setup for ZC702 is complete...
```

```
MATLAB will use following settings to communicate with ZC702 board:
```

```
IP Address      :172.28.144.60  
User name       :root  
Password        :root  
Build-directory :/root  
COM port        :COM20
```

```
h.openShell('serial');
```

Note

- `h = zynq;` creates a handle, `h`, for the connection with the Zynq platform.
- `h.setupZynqHardware();` uses the serial-over-USB connection to get information from the Zynq platform and displays it on the command line.
- `h.openShell('serial');` opens a PuTTY Configuration window.

3 In the PuTTY dialog box that opens, select the **Serial** category.

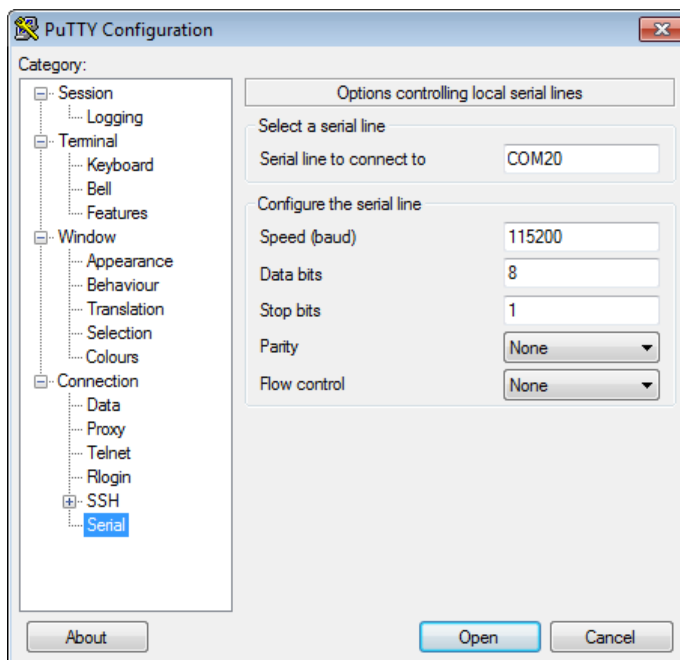

4 Enter the following values:

- **Serial line to connect to:** Enter the COM port number.
- **Speed:** 115200
- **Flow control:** None

- 5 In the PuTTY dialog box, select the **Session** category.

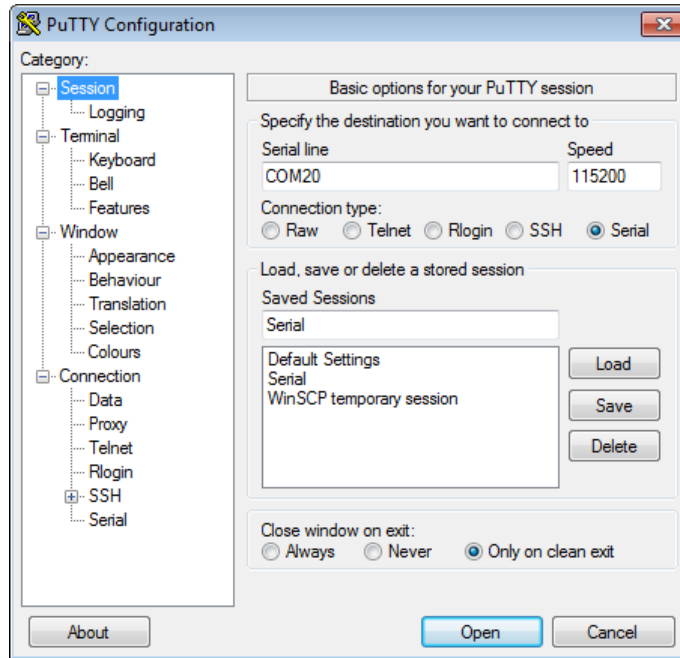

- 6 For **Connection type**, select **Serial**.
- 7 For **Saved Sessions**, enter a new name, such as “Serial”.
- 8 Click **Save**, and then click **Open**.
- 9 When a terminal window opens, press the **Enter** key on your keyboard. The terminal window displays a Linux command prompt.

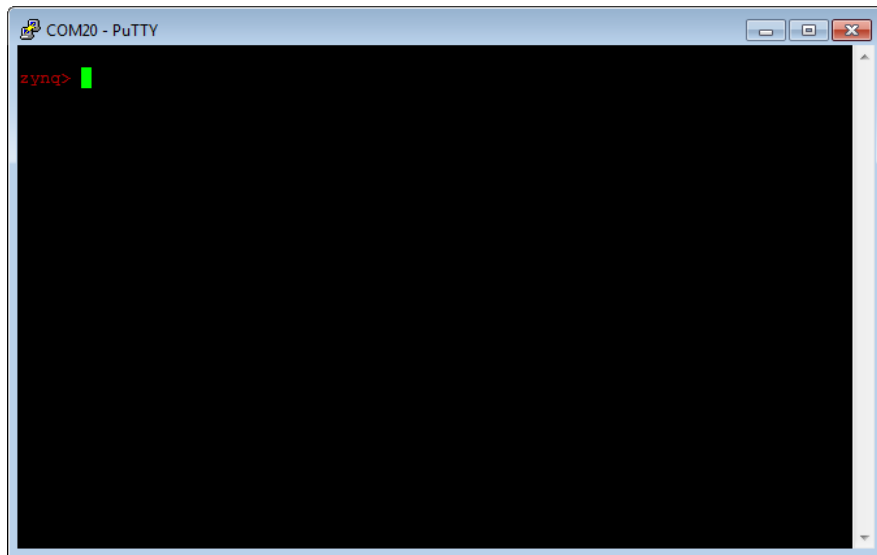

- 10 When you are finished, close the terminal window.

Leaving the terminal session open prevents the build process connecting to the Zynq platform and produces a build error.

If you have trouble determining the COM port number, you can use this alternative approach:

- 1 In Windows 7, open **Devices and Printers**.
- 2 Locate the USB device that connects to the Zynq platform, such as **Silicon Labs CP210x USB to UART Bridge**. The device name includes the port number. For example:

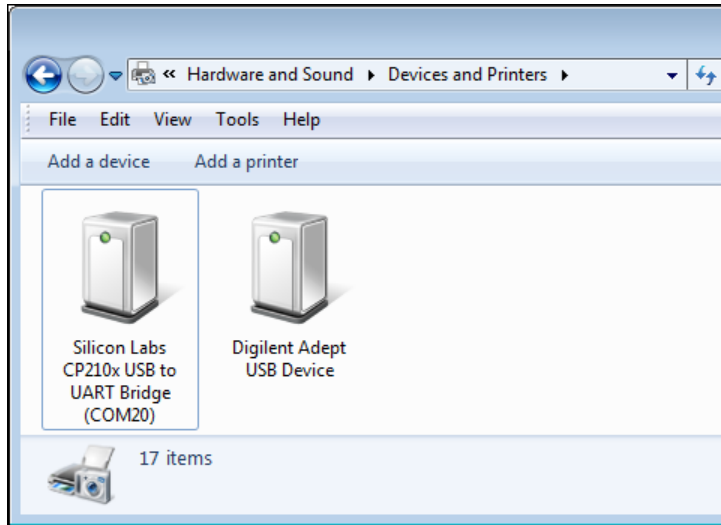

A

- absolute time 14-27
- access properties 38-26 40-29
- acquisition window
 - ADC blocks
 - ACQ_PS 44-54
- additional options
 - adding custom comments 15-4
 - delimiter for #includes 15-101
- adivdsp 38-24
- adivdsp object properties 38-31
 - procnum 38-30
 - sessionname 38-30
- algorithms
 - verifying in context of complete real-time target environment 30-1
- Alias 9-10
- Analog Devices model reference 38-36
- apiversion 42-53
- Archive_library 38-38 40-42 42-66 45-31
- ASAP2 files, generating 44-46
- asynchronous scheduling 45-19
- attributes 8-56
- AUTOSAR 4-2
 - standards, complying with 4-5

B

- Bitfield (Custom) 9-7
- block limitations using model reference 38-38
 - 40-43 42-66 45-31
- blocks
 - adding to model 44-26
- boardnum 42-53
- boards, selecting 35-19 42-58
- Browse button
 - on Code Generation pane 14-24
- build folder
 - contents of 45-43
 - naming convention 45-40

- build format 35-9
- building models
 - use C62x DSP Library blocks 45-96

C

- c2000lib startup 44-25
- C6000 model reference 42-64 45-29
- C6000 Target
 - targeting Code Composer Studio™ 45-47
- C62x DSP Library blocks
 - building models 45-96
 - choosing blocks to optimize code 45-97
 - common characteristics 45-91
 - Q format notation 45-93
 - using source and sink blocks 45-97
- C6713 DSK
 - confirming configuration 45-37
 - start/stop-models 45-35 45-47
 - tutorial about multirate applications 45-38
- C6713 DSK blocks
 - tutorial 45-38
- C6713 DSK folders
 - build 45-40
 - working 45-40
- CAN
 - timing parameters
 - Bitrate 45-98
- CAN/eCAN
 - timing parameters
 - Bitrate 44-30
- CCS 42-2 43-2
 - See also* Code Composer Studio™
- CCS IDE
 - create projects for the IDE 45-47
- CCS IDE objects
 - tutorial about using 42-9
- ccsappexe 42-53
- changing identifier names 8-79
- classes 8-56

- clock speed 44-8
- Code Composer Studio 45-47
 - MATLAB API 42-5
- Code Composer Studio™ 42-2 43-2
- code generation
 - overview 44-28
- code generation options
 - Application lifespan (days) 24-3
 - Bitfield declarator type specifier 24-4
 - Classic call interface 14-28
 - code style pane 15-26
 - Configure Step Function 14-29
 - Custom comments 15-2
 - External mode 24-6
 - Fixed-point exception protection 24-3
 - Generate reusable code 14-28
 - Identifier format control 15-12
 - MAT-file logging
 - clearing 26-5
 - Pack Boolean data into bitfields 24-4
 - Parameter structure 24-3
 - Pass reusable subsystem outputs as 24-4
 - Pass root-level I/O as 14-30
 - Requirements in block comments 15-2
 - Reusable code error diagnostic 14-30
 - Simplify array indexing 24-3
 - Simulink block descriptions 15-2
 - Simulink data object descriptions 15-2
 - Single output/update function 14-28
 - clearing 20-16
 - Stateflow object descriptions 15-2
 - Support absolute time 14-27
 - Support complex numbers 14-27
 - Support continuous time 14-27
 - for using continuous time blocks 7-2
 - limitations 21-4
 - Support floating-point numbers 14-26
 - Support non-finite numbers 14-27
 - Support noninlined S-functions 14-27
 - Suppress error status in real-time model
 - data structure 14-29
 - Terminate function required 14-28
- Code generation options 9-5
- Code Generation pane
 - target configuration options
 - Browse button 14-24
 - system target file field 14-24
- Code Generation Report 8-77
- code modules, generated 16-8
- code optimization 44-97
- code replacement library. *See* CRL
- code style
 - controlling 15-26
- code templates
 - example of use 15-39
 - generating code with 15-40
 - structure of 15-36
 - summary of API 15-51
- code tracing
 - by using HTML reports 28-4
- code, generated
 - verifying in target environment 29-1
- code, user-written 16-11
- codegen
 - generating reusable, reentrant code 16-14
- comments
 - adding custom 15-4
 - adding global 15-6
- Complexity 9-4
- component models
 - verifying in context of complete real-time
 - target environment 30-1
- configuration default 42-2
- Configuration Wizard buttons 14-33
- confirm your C6713 DSK configuration 45-37
- Const (Custom) 9-7
- ConstVolatile (Custom) 9-8
- controllers

- verifying in context of complete real-time target environment 30-1
- controlling signal storage 25-4
- convert data types 45-96
- CPU clock speed 44-8
- create custom Code Replacement Library 37-8
- creating a data dictionary 8-57
- CRL 23-1
 - assessing execution time after selecting a library 37-4
 - build information for code replacements 23-161
 - cache hits and misses 23-198
 - conceptual view of function or operator 23-4
 - create a custom library 37-8
 - defining 23-18
 - examining 23-191
 - optimization 37-2
 - registering 23-203
 - reserved identifiers 23-165
 - RTW.copyFileToBuildDir 23-163
 - rtwTargetInfo.m file 23-203
 - seeing the library changes in your generated code 37-5
 - selecting in MATLAB Coder 23-11
 - selecting in Simulink 23-10
 - selecting the library to use 37-4
 - sl_customization.m file 23-203
 - table definition file 23-18
 - table entry 23-4
 - target-specific implementation of function or operator 23-4
 - TargetFcnLibHandle 23-198
 - tracing generated code 23-195
 - use in the build process 37-3
 - using with link software 37-2
 - validating 23-191
 - viewer 23-192
 - viewing library tables 37-8
 - when to use 37-4

- workflow 23-10
- custom C6000 target
 - about 45-52
 - preferences block 45-52
 - setup 45-52
- custom code generation
 - of file banners 15-55
 - with code templates 15-35
- custom comments 15-4
- custom file processing (CFP) template 15-28
- custom hardware guidelines 45-49
- custom hardware, target 45-49

D

- daexplr command 8-60
- Data access 9-9
- data dictionary 8-55
 - introduction 8-55
 - See also* data objects
- data initialization
 - of floats and doubles 24-2
 - of internal states 24-2
 - of root-level I/O ports 24-2
- data object wizard 8-57
- data objects
 - adding missing 8-57
 - naming rules
 - changing #defines 8-86
 - changing parameter names 8-85
 - changing signal names 8-85
 - properties 9-3
 - setting property values 8-60
 - wizard 8-57
- data placement
 - introduction 15-74
 - rules for 15-94
 - settings 15-74
- data templates 15-28
- Data type property 9-3

- data type support 44-6
 - data types
 - conversion 44-97
 - creating 8-35
 - dataobjectwizard 8-58
 - Default (Custom) storage class 9-5
 - default build configuration 42-2
 - Define (Custom) 9-8
 - defining one object in its own file 8-79
 - Definition file 9-6
 - Definition File priority 15-80
 - Description 9-10
 - design specification
 - developing 2-1 7-1
 - dialog boxes
 - Configure AUTOSAR Interface 17-43
 - Model Interface 12-3
 - Dialog boxes
 - Model Explorer 8-60
 - Dimensions 9-4
 - Direct 9-9
 - DO-178C 4-2
 - standards, complying with 4-11
 - DO-178C Standard 4-11
 - DO178-C 4-2
 - DocBlock 15-6
 - domain
 - installing products for 2-1
 - DSP/BIOS
 - added files 45-71
 - files removed from project 45-71
 - to enable 45-68
 - DSP/BIOS, enabling 45-68
- E**
- Eclipse™ IDE for C/C++ Developers 39-5
 - elapsed time 14-27
 - Embedded Coder®
 - about 45-2
 - create Simulink® model for targeting 45-38
 - expected background for use 45-3
 - information for new users 45-3
 - listing link functions 42-47
 - enabling DSP/BIOS 45-68
 - execution in timer-based models 45-20
 - execution profiling
 - subsystem 36-23
 - export filters to CCS IDE from FDATool 42-69
 - select the export data type 42-72
 - set the Export mode option 42-71
 - ExportToFile (Custom) 9-8
 - external data dictionary
 - importing data objects from 8-68
 - External mode support 24-6
- F**
- FDATool. *See* export filters to CCS IDE from FDATool
 - file banners, generation of 15-55
 - file packaging 16-8
 - files added to DSP/BIOS project 45-71
 - files removed from DSP/BIOS projects 45-71
 - fixed-point numbers 44-91 45-91
 - signed 45-92
 - Frame based 9-4
 - functions
 - overloading 38-28 40-32 42-50
- G**
- generate optimized code 35-8
 - generated code
 - modules 16-8
 - verifying in target environment 29-1
 - generating reusable, reentrant code
 - codegen 16-14
 - Get function 9-9
 - GetSet (Custom) 9-9

GetSet custom storage class 10-61
 getting properties 38-27 40-31
 ghsmulti 40-28
 ghsmulti object properties 40-34
 portnum 40-34
 procnum 40-33
 Global (Custom) storage class 9-5
 global comments
 using DocBlock 15-6
 using Simulink annotation 15-9
 using sorted notes 15-10
 using Stateflow note 15-9
 Global priority 15-79
 GNU® Tool Chain on Linux® 39-6
 GNU® Tool Chain on Windows® 39-7
 Green Hills MULTI® IDE objects
 tutorial about using 40-12
 Green Hills Software model reference 40-40
 guidelines
 MISRA C® 4-5

H

hardware 45-5
 Hardware Implementation parameters
 configuration of 24-5
 hardware, custom 45-49
 Header file 9-6
 Header File priority 15-80
 heap size, set heap size 35-12
 high-speed peripheral clock 44-8

I

identifier format control parameters 15-16
 identifier format control tokens 15-14
 IEC 61508 4-2
 standards, complying with 4-7
 IEC 61508 Standard 4-7

import filter coefficients from FDATool.. *See*
 FDATool
 ImportFromFile (Custom) 9-9
 inaccurate profile information 45-75
 #include
 specifying delimiter 15-101
 industry standards and guidelines
 modeling and coding 4-2
 initialized memory 45-51
 inserting custom comments 15-4
 inserting global comments 15-6
 installing software 44-3 45-5
 integer-only code 26-4
 integer-only code generation 26-4
 interrupts, servicing 20-3
 IQ Math library 44-90
 building models 44-96
 code optimization 44-97
 common characteristics 44-91
 Q format notation 44-93
 ISO 26262
 standards, complying with 4-9
 ISO 26262 Standard 4-9
 issues, using PIL 36-19

L

link filters properties
 getting 38-28 40-31
 link properties
 about 38-30 40-32 to 40-33 42-50 42-52
 apiversion 42-53
 boardnum 42-53
 ccsappexe 42-53
 numchannels 42-53
 page 42-54
 procnum 42-54
 quick reference table 42-51
 rt dx 42-55
 rt dxchannel 42-56

- setting 38-28 40-31
- timeout 42-56
- version 42-56

link properties, details about 38-30 40-33 42-52

linking objects

- quick reference 38-28

links

- closing CCS IDE 42-25
- closing Green Hills MULTI® 40-26
- closing RTDX 42-44
- closing VisualDSP++® 38-23
- communications for RTDX 42-35
- creating links for RTDX 42-33
- details 38-30 40-33 42-52
- introducing the tutorial for using links for RTDX 42-28
- loading files into CCS IDE 42-17
- loading files into Green Hills MULTI® IDE 40-19
- loading files into VisualDSP++® IDE 38-16
- quick reference 40-32 42-50
- running applications using RTDX 42-37
- tutorial about using links for RTDX 42-27
- working with your processor 38-17 40-21 42-19

M

main program

- modifying 20-4
- operation of 20-3

main program (rt_main)

- static module 20-12

management, memory 45-51

map memory 45-51

map, memory 45-51

math blocks. *See* IQ Math library

MathWorks Automotive Advisory Board (MAAB)

- guidelines, complying with 4-4

MathWorks® Automotive Advisory Board (MAAB) 4-2

MATLAB functions

- #define naming 8-86
- parameter naming 8-85
- signal naming 8-85

Maximum property 9-5

MemConst 9-5

MemConstVolatile 9-5

memory

- initialized 45-51
- management 45-51
- map 45-51
- section 45-51
- segment 45-51
- uninitialized 45-51

memory maps 45-51

Memory section 9-5

MemVolatile 9-5

Minimum property 9-4

MISRA C 4-2

MISRA C®

- guidelines, complying with 4-5

MISRA C® guidelines 4-5

model

- add blocks 44-26
- building overview 44-22
- IQmath library 44-96

model design specification

- developing 2-1 7-1

model execution 45-19

Model Explorer

- parameter and signal properties 9-3

model reference 38-36 40-40 42-64 45-29

- about 38-36 40-40 42-64 45-29
- Archive_library 45-31
- Archive_library 38-38 40-42 42-66
- block limitations 38-38 40-43 42-66 45-31
- modelreferencecompliant flag 38-39 40-43 42-67 45-32

- setting build action 38-38 40-42 42-66 45-31
 - using 38-38 40-42 42-66 45-30
- model schedulers 45-19
- modelreferencecompliant flag 38-39 40-43 42-67 45-32
- modifying rt_OneStep 20-10
- mpt (module packaging tool) data object 8-56
- MULTI
 - starting from MATLAB 40-14
 - stopping from MATLAB 40-14

N

- name mangling 15-18
- naming rules
 - applying globally 8-79
 - changing parameter names 8-85
 - changing signal names 8-85
- numchannels 42-53

O

- object
 - adivdsp 38-24
 - ghsmulti 40-28
 - ticcs 42-48
- object properties
 - about 38-28
 - quick reference table 38-29 40-32
- objects
 - creating objects for CCS IDE 42-15
 - creating objects for Green Hills MULTI® IDE 40-18
 - creating objects for VisualDSP++® IDE 38-14
 - introducing the objects for CCS IDE
 - tutorial 42-9
 - introducing the objects for Green Hills MULTI® IDE tutorial 40-12
 - introducing the objects for VisualDSP++® IDE tutorial 38-9

- selecting processors for CCS IDE 42-13
- selecting processors for VisualDSP++® IDE 38-13
- tutorial about using IDE Automation
 - Interface for CCS IDE 42-9
- tutorial about using IDE Automation
 - Interface for Green Hills® MULTI® IDE 40-12
- tutorial about using IDE Automation
 - Interface for VisualDSP++® IDE 38-9
- optimization code 44-97
- optimization, processor specific 35-8
- optimize code 45-97
- Oracle® Java® Runtime Environment 39-3
- overloading 38-28 40-32 42-50
- Owner 9-6
- ownership
 - explanation 15-81
 - settings 15-81
- Ownership priority 15-80

P

- package 8-56
- page 42-54
- Parameter class 8-56
- parameter names
 - changing all 8-85
- Persistence level 9-7
- PIL issues 36-19
- Pointer 9-9
- portnum 40-34
- priority and usage 15-75
 - Definition File priority 15-80
 - Global priority 15-79
 - Header File priority 15-80
 - introduction 15-75
 - Ownership priority 15-80
 - Read-Write priority 15-76
 - See also* interdependent settings

- processor configuration options
 - build action 35-9
 - overrun action 35-10
 - processor specific optimization 35-8
 - processor-in-the-loop (PIL)
 - communications API 31-42
 - connectivity API 31-39
 - connectivity API examples 31-51
 - connectivity configuration 31-40
 - custom target 31-40
 - limitations 31-55
 - rtiostream API 31-42
 - target connectivity API 31-40
 - procnum 38-30 40-33 42-54
 - profile generated code 45-72
 - profile report
 - about 45-72
 - correcting inaccurate profile
 - information 45-75
 - CPU clock speed 45-81
 - maximum percent of interrupt interval (Max %)
45-81
 - maximum time spent in this subsystem per
interrupt (Max time) 45-81
 - number of interrupts counted 45-80
 - profiling subsystems 45-73
 - reading 45-79
 - sample 45-79
 - STS objects 45-81
 - timing details 45-74
 - to generate 45-82
 - profiling execution
 - by subsystem 36-23
 - program execution
 - main program 20-3
 - rt_OneStep 20-5
 - multirate multitasking operation 20-7
 - multirate single-tasking operation 20-10
 - reentrancy 20-9
 - single-rate single-tasking operation 20-6
 - project generation
 - selecting the board 35-19 42-58
 - projects, create for CCS IDE 45-47
 - properties
 - link properties 40-32 42-50
 - object properties 38-28
 - referencing directly 38-28 40-31
 - retrieving 38-26 40-29
 - function for 38-27 40-31
 - retrieving by direct property
 - referencing 38-28 40-31
 - setting 38-26 40-29
 - property values
 - definition 8-55
 - descriptions 9-3
 - setting 8-60
 - pure integer code 26-4
 - and external mode 24-7
- ## Q
- Q format 44-93
 - Q format notation 45-93
- ## R
- rate grouping 20-8
 - Read-Write priority 15-76
 - reentrant code 14-28
 - codegen 16-14
 - reset 44-23
 - reusable code 14-28
 - codegen 16-14
 - rt_main.c 20-12
 - rtdx 42-55
 - RTDX links
 - tutorial about using 42-27
 - rtdxchannel 42-56
 - RTW.copyFileToBuildDir 23-163
 - rtwdemo_mpf 8-71

run the DSK confidence test 45-37

S

S-function wrapper generation 21-2

Sample based 9-4

Sample mode 9-4

Sample time 9-4

scheduling 44-7

section, memory 45-51

segment, memory 45-51

selecting boards 35-19 42-58

sessionname 38-30

Set function 9-9

set heap size 35-12

set properties 38-26 40-29

set stack size 35-11

Signal class 8-56

signal names

 changing all 8-85

signed fixed-point numbers 44-93 45-92

simulator

 device cycle accurate 45-10

 use simulators for development 45-10

 use with DSP/BIOS 45-10

simulators, about 45-10

Simulink annotation 15-9

solver modes, permitted 20-5

sorted notes 15-10

source and sink blocks 45-97

source code files, generated 16-8

specification

 developing 2-1 7-1

stack size, set stack size 35-11

standards

 DO-178C 4-11

 IEC 61508 4-7

 ISO 26262 4-9

standards and guidelines, modeling and coding 4-2

start MULTI from MATLAB 40-14

startup c2000lib 44-25

Stateflow note 15-9

stop MULTI from MATLAB 40-14

Storage class 9-5

Struct (Custom) 9-9

Struct name 9-7

structure-like referencing 38-28 40-31

supported hardware 45-5

symbols for templates

 alphabetical list 15-66

synchronous scheduling 45-20

system requirements 45-5

System Target File Browser 14-25

system target files

 selecting programmatically 14-25

T

target Code Composer Studio™ 45-47

target connectivity API 31-40

target custom hardware 45-49

target environment

 verifying generated code in 29-1

targets

 selecting programmatically 14-25

task identifier (tid) 20-8

templates

 example with generated file 15-48

 rules for creating or modifying 15-70

 symbols 15-66

ticcs 42-48

tid 20-8

timeout 42-56

 timeout 38-31 40-34

timer interrupts 20-3

timer-based models, execution 45-20

timer-based scheduler 45-20

timing 45-19

 interrupts 44-7

- tutorial
 - changing identifier names 8-81
 - changing organization of generated file 15-37
 - creating a data dictionary 8-70
 - defining objects in separate file 8-77
 - defining one object in its own file 8-79
- tutorial for C6713 DSK blocks 45-38
- tutorials
 - links for RTDX 42-27
 - objects for CCS 42-9
 - objects for Green Hills MULTI® 40-12
 - objects for VisualDSP++® 38-9

U

- uninitialized memory 45-51
- Units 9-3
- use blocks for the C6713 DSK 45-38
- use C62x and C64x DSP Library blocks 45-89
- use C6713 DSK blocks 45-38

- User data type 8-35
- User object type 9-3

V

- Value 9-3
- version 42-56
- viewing Code Replacement Libraries 37-8
- virtualized output port optimization 25-2
- VisualDSP++® IDE objects
 - tutorial about using 38-9
- Volatile (Custom) 9-7

W

- Web view
 - browser requirements 18-6
- wizard
 - data object 8-57
- working folder 45-40